



Werkzeuge fürs Leben • Tools for life



CATALOGUE 

2011



Dear GEDORE customers and users,

Informative, user-friendly and technical - I am delighted to present our new price catalogue!

This catalogue provides comprehensive know-how and tool knowledge. In order to make your product selection as uncomplicated as possible, you will find all of the requisite technical information and order data in tabular form on the product pages. References to accessories and product information are provided wherever practical.

As the market leader, we see our task as combining a distinctive awareness of quality with personal support for our customers.

Our many years of competence as a tool manufacturer operating at international level enables you to rely on premium products "Made in Germany - Made by GEDORE".

Our skilled and committed employees give their best every day to supply you with high-quality products "Made in Germany - Made by GEDORE". Using environmentally-friendly production methods, we ensure that pollutants are kept to a minimum for man and his environment.

The following pages should succeed at convincing you of the range of services we offer "Made in Germany".

Sincerely,
K. Dowidat



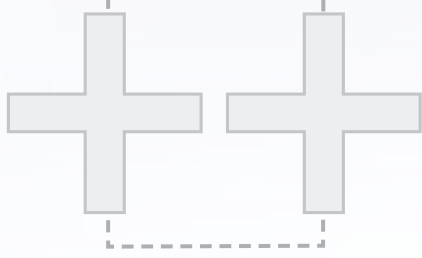

PREMIUM QUALITY "MADE IN GERMANY" +

The modern-day GEDORE Group embraces a large number of specialist tool companies, manufacturing world-renowned branded products. This allows us to supply professional users with a wide product range from a single source. The combined range supplied by the highly specialised manufacturers in our group amounts to 18,000 quality products. Each member of the group stands for reliable development and production of custom and special tools.

With its Research and Development department, the Group is able to react flexibly to changing market requirements. Continuous development of existing products and the development of new, patentable products are driven by targeted product marketing.



PEOPLE AT GEDORE +

GEDORE emphasizes quality, expertise, effectiveness and reliability. To maintain this, we invest continuously in production technology and development in our region. But even with leading-edge production technology, nothing at GEDORE takes priority over the care, precision, craftsmanship and experience of well-qualified employees. The quality concept, "Made in Germany", stands above all for the skill, loyalty and commitment of our employees.



ENVIRONMENTAL PROTECTION FOR FUTURE GENERATIONS

Maintaining a healthy environment by keeping air, ground and water clean, takes top priority for the GEDORE Group, because we see this as a social obligation. Germany can be secured as a production location in the long term only if we secure the natural resources for future generations. Recirculation systems and recycling water and chemicals in electroplating, together with low-emission powder coating in the paint shop and low-emission forging are just a few points of our comprehensive environment management policy.



RFID technology

CROSS CHECK

➤ RFID tagged tools = electronic control

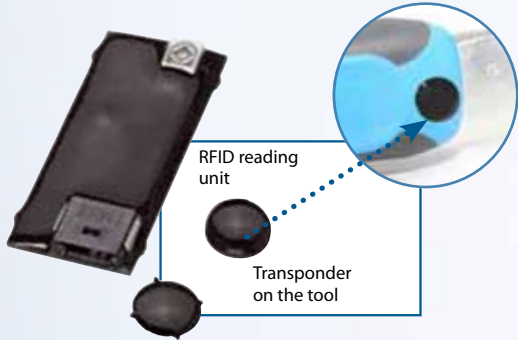

RFID-CHECK-TOOL-SYSTEM

- A complete check via RFID technology (Radio Frequency Identification) and additionally with 2 coloured plastic inlays.
- Particularly suited for work in sensitive areas, in which it must be assured that no tools are left behind.
- Missing tools would be signaled by Bluetooth® or USB (Universal Serial Bus) on a display of your choice. PC, Palm, or Pocket PC are possible.
- Every tool is supplied with a transponder (tag), which via the internal UID number (Unique Identifier) is worldwide clearly identifiable.
- Also the tool trolley / tool box can be clearly identified.
- The passive transponder changes the characteristics of the electromagnetic waves reading unit. Passive transponders do not send out any electromagnetic waves.
- The RFID reading unit registers the identification of the missing tool on the chosen display. Missing tools will be reassigned to the user.
- The system works with 13,56 MHz in short wave range.
- The outreach of the system is limited to a maximum of 10 mm.
- Tools which have been put aside will first be entered when they have been placed in their nest. To interchange or to mix up is therefore impossible.
- Resistant against interference radiation. The tool trolley works like a Faraday cage and shields other electromagnetic radiation.
- Splashproof.
- The area of activity of the transponder is from -20 to +100° C.
- The RFID reader unit is operated with a refill rechargeable accumulator. "Warning for empty battery"



Upon request all tool trolleys 2004, 2005 and benches 1504, 1504 XL, 2430 can be equipped with the RFID system.



Contact:
gedore-solutions@gedore.com





➤ CHECK-TOOL insert = visual control



Options:

- Data interface: W-LAN : LAN :
- Bluetooth UHF transponder
- Individual software programming
- Electronic lock (consisting of: 3x user key, 1x administrator key, 3x user key transponder)
- 2-colour LEDs for optical check



2004 AKKU ENERGY TROLLEY

A sturdy workshop trolley with high comfort for industry, automotive, trade and aerospace

SELF-SUFFICIENT WORKPLACE

- Four German-style Schuko sockets
- Shaped plug
- Safety cutout and RCD
- On/off switch
- Battery indicator



- Sturdy working platform in ABS with three compartments for small parts and raised edge, offers additional store-room. Resistant to oil and acid
- Static load capacity up to 500 kg
- Safety cutout and RCD
- Load capacity per drawer 40 kg, bottom heavy-duty drawer 60 kg
- Drawers with ball bearings, 100% extendable and all individual partitionable. Delivery includes length- and crosswise dividers. Drawer combinations and maximum volumes may be selected individually to suit every workshop. Safety lock guarantees that the drawer will not slide open while the trolley is moving
- GEDORE high-performance wheels, with tyres that adapt to suit different loading
- All-round heel and impact protection for your safety
- 5 metres cable with mains plug and auto cable rewind system
- Central locking
- Strong handle, easy action
- Four German-style Schuko sockets
- Battery indicator

1500 AKKU ENERGIEMODUL

- Efficient power-aid
- Energy module 1500 AKKU for retrofitting all standard trolleys



FEATURES

- The tried and tested 2004 tool trolley with integrated energy module and self-contained energy storage
- Cordless operation with lead-gel rechargeable battery and 230 V inverter
- 800 W output power, short-time 1300 W peak power, 200 W continuous power over 3 hours
- Battery indicator monitors the charge state, actual energy consumption and many other functions
- Optical alarm signal, overload and low battery safety shut-down
- 230 V mains power supply socket

- All GEDORE energy trolleys 2004 AKKU and workbenches 1504 AKKU are equipped with a CEE 7/17 shaped plug.
- The special geometry of this plug allows it to be used in more than 100 countries worldwide.
- International and other plug variants are available on request.





- Comprehensive imperial range for a wide range of applications
- Whitworth and AF (across flats)
- Spanners and sockets
- Applications include aviation, American motorcycles and trucks



AEROSPACE ASSORTMENTS

2004 RotorTec 

Contact:
aerospace@gedore.de



S 1085 A





TOOLS CONTAINER FOR THOSE TOUGH SITE ASSIGNMENTS ...



Allows you to work professionally on-site...
... reliably, quickly, flexibly and at low cost
- to your standards!



- Optimises and speeds up operating sequences
- Can be individually equipped and rigged up
- Cuts logistics costs
- Best-possible material / best-possible tackle
- Reduces itineraries

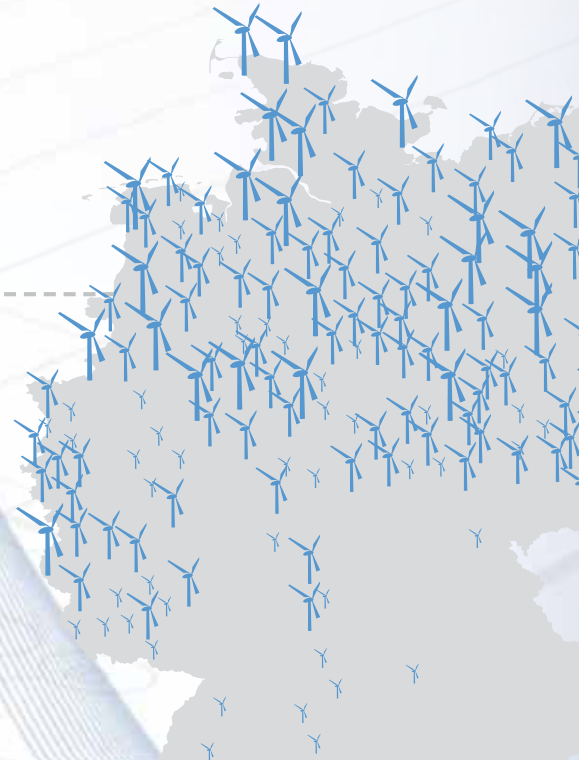

Interested?

Have a talk with us - together we can work out your container concept to your requirements/wishes.
gedore-solutions@gedore.com



TECHNICAL SYMBOLS

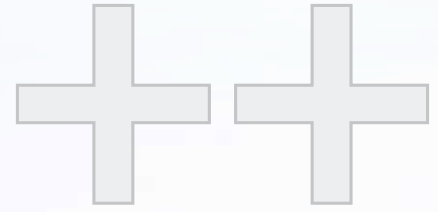

g	Weight (total)	Z-94	Ratchet used		Drive sections
kg	Weight (total)	U-2	Ratchet used		Slotted
kg	Weight (total)	U-3	Ratchet used		Cruciforme PH
kg	Weight hammer head	U-10	Ratchet used		Cruciforme PZ
mm	Length (total)	U-20	Ratchet used		Internal square
mm	Length (total)		6.3 1/4		External hexagon
L	Length (total)		10 3/8		External hexagon with tamper proof hole
mm	Length (total)		12.5 1/2		Internal single hexagon
mm	Length of blade		20 3/4		Bi-hexagon
mm	Length of blade		25 1		Unit Drive
mm	Length of shaft / handle		6.3 1/4		Unit Drive
mm	Length of point / blade		10 3/8		Unit Drive
mm	Diameter (also dia. of head, of shaft, of points)		12.5 1/2		Internal-TORX®
"inch	Diameter		20 3/4		TORX® Macho Inviolable
"AF	Diameter		25 1		TORX® Hembra
mm "inch	Diameter of hole (external)		4		Internal serrations XZN
mm "inch	Diameter of hole (internal)		6.3 1/4		Multi-spline RIBE®
mm	Width across flats (Nominal Width)		8 5/16		Hexagon
mm	Width across flats (Nominal Width)		4		Bi-hexagon
"AF	Width across flats (Nominal Width)		6.3 1/4		Cutting edge thickness
mm	Width across flats (Nominal Width)		8 5/16		Jaw width / tape width
Whitw.	Width across flats (Nominal Width)		Puller		Head width
mm	Width across flats (Nominal Width)		Clamping spread		Conformity with EU guidelines
mm	Width across flats (Nominal Width)		Clamping reach		VDE Test Symbol
mm	Width across flats (Nominal Width)		Size of spindle		For working in voltage areas up to 1000 V
mm	Width across flats (Nominal Width)		Hydraulic spindle		VDE Test Symbol (protective equipment)
M	Thread size, connection thread		Throat depth		
M	Screw dimension (type of thread)		Depth of opening / Clamping width / Clamping range		





	Wire rope		File profile square		Angle
	Gripping face cross-hatched		Blade / Cutting edge width		Weld-on end fitting
	Gripping face without file-cut		Blade thickness		End fitting with hexagon wrench
	Gripping face with file-cut		Gear ratio		Open end fitting
	Jaws, angled 45°		Output torque (max. N-m)		Flared end fitting
	Flat jaws		Input torque (max. N-m)		Ring end fitting
	Flat-round jaws		Scale divisions		End fitting with square head
	Round jaws		Single square drive		Bit holder end fitting
	Type of jaw straight		Double square drive		Ratchet end fitting
	Type of jaw half-round		9x12 14x18		Anti-wind-up-ratchet
	Type of jaw round		Drive connector		Factory certificate
	Cutting edge with bevel		Spigot-end drive		Visual display digital
	Cutting edge without bevel		in cardboard or plastic packaging		RS 232 interface
	Straight jaws		in sheet metal box		Bi-directional tightening
	Angled jaws 45°		Set in sheet metal or plastic box		Audible reaction (click)
	Angled jaws 90°		Head width		Mechanical torque multiplier
	Internal retaining rings		Distance, hole to edge		Integrated electronic hardware
	External retaining rings		GS Seal of tested quality		DREMOMETER MINI-F operable w/o inaccuracies
	EPA / ESD electrostatic discharge		Magnetic		1% Tolerance
	Electronic		Radius		3% Tolerance
	File profile flat		new		4% Tolerance
	File profile three-edged		Packaging unit		6% Tolerance
	File profile round		Drawer	P.O.A.	Price on application / Price and delivery time on application
	File profile half-round		Door		
			Shelf		
			Pivoting angle		



Subscribe to the GEDORE Newsletter
at www.gedore.com ...



++ DO YOU KNOW ABOUT OUR SPECIALIST CATALOGUES...

GEDORE 
OCHSENKOPF 
KLANN 



WORKSHOP EQUIPMENT

TOOL TROLLEYS, WORKBENCHES, TOOL CABINETS, TOOL BOXES



12 - 51



TOOL ASSORTMENTS, CASES, BOARDS, ES MODULES, CT MODULES



52 - 93



SPANNERS



94 - 141



SOCKETS AND ACCESSORIES



142 - 229



TORQUE TOOLS



230 - 287



SCREWDRIVERS



288 - 305



PLIERS



306 - 357



PULLERS



358 - 417



HAMMERS AND STRIKING TOOLS



418 - 461



SPECIAL TOOLS, MEASURING TOOLS, TOOLS FOR BYCICLES, INDUSTRIAL CUTLERY



462 - 475



SCREW CLAMPS



476 - 479



WORKSHOP LAMPS



480 - 483



@WORK



484 - 487



COROSTOP TOOL



488 - 499



VDE INSULATED SAFETY TOOLS



500 - 515



INSTALLATION TOOLS



516 - 541



PIPE BENDING SYSTEMS
AUTOMOTIVE TOOLS



568 - 589



TECHNICAL INFORMATION

590 - 605



INDEX / DISCLAIMER

606 - 623



GENERAL HAND TOOLS

OCCUPATIONAL TOOLS



GEDORE

GEDORE 1504 XL



++ TOOL CONTROL +



SERVICE / FEATURES		14 - 17
TOOL TROLLEYS		18 - 29
ACCESSORIES TOOL TROLLEYS		30 - 31
WORKBENCHES		32 - 37
ACCESSORIES WORKBENCHES		38
FOLDING WORKBENCH		38
WORKBENCHES SELF-ASSEMBLY RANGE		39
DRAWER CABINETS		39
TOOL CABINETS		40
USEFUL HELPERS FOR TOOL TROLLEYS / WORKBENCHES		41 - 42
TOOL HOLDERS / TOOL HOOKS		42 - 47
TOOL CHESTS / TOOL BOXES		48 - 49
TOOL CASES / ROLLER TOOL CASES		49 - 51



TOOL ASSORTMENTS MODULES



52 - 93



WORKSHOP EQUIPMENT

GEDORE WORKSHOP FURNITURE...

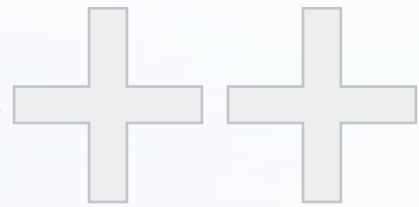

+ BEST-POSSIBLE QUALITY FOR THE HIGHEST DEMANDS PLACED

- ✔ Use of the most up-to-date machinery and environmentally-friendly production processes
- ✔ The basis is tightly-controlled and choice sheet steel
- ✔ Experienced and reliable specialists vouch for precision-like processing
- ✔ Stringent quality checks after each production step ensure a constantly high level
- ✔ Best-possible industrial quality for those extreme levels of constant use and conditions subjected to
- ✔ Professional service up to the development of special customised tools

+ GEDORE WORKSHOP FURNITURE... FORM AND FUNCTION PERFECTION

- ✔ Whether mobile or stationary: indispensable aids, in fact, for the rough-and-ready of workshop routine
- ✔ Extremely robust, scratch and impact-resistant, corrosion-proof and easy to care for
- ✔ Durable and highly resilient with stability of the highest-order
- ✔ Numerous models to reflect use and individual requirements
- ✔ Varied, optional accessories available for flexibly extending all the basic models
- ✔ Specific colours (RAL) and outfits (e.g. stainless steel, oil/acid-resistant etc.) on request



+ GEDORE WORKSHOP FURNITURE... INTELLIGENTLY DESIGNED – DEPENDABLE UNDER EXTREME USE

- ✔ Vertical and horizontal forces are calculated with precision
- ✔ Unloaded weight optimization from a finely-tuned material input
- ✔ Robust, stable 0.88 mm thick sheet steel structure, supporting elements of a 1.00 mm metal thickness, a 2.00mm metal thickness for the heavy-duty chassis
- ✔ Precision spot welding ensures components stay permanently fixed
- ✔ Tool trolleys have it all with their special GEDORE chassis and GEDORE heavy-duty wheels
- ✔ Durable and highly resilient with stability of the highest-order



GEDORE WORKSHOP FURNITURE... + ... TIDY LOOK, UNCLUTTERED AND ALWAYS AT HAND

- ✔ Ready to be used straight after delivery: simply unpack and screw on the manoeuvring handle
- ✔ Whether a mobile or stationary guardian of tidiness: each tool has its own place here
- ✔ Modular arrangement systems make daily routine that much easier (visual check/tool missing)
- ✔ Compact tool assortments make selection easier
- ✔ Customised equipment/tool sets in module systems and/or trolleys/benches in company design/colours



+ THE GEDORE CHARACTER

Individual drawer locking (not applicable to 2003)

- In addition to the central locking, each drawer has its own separate latch to prevent unwanted opening, when being moved
- The latch is automatically released by a tilting bar when the drawer is opened
- The single latch automatically engages when the drawer closes

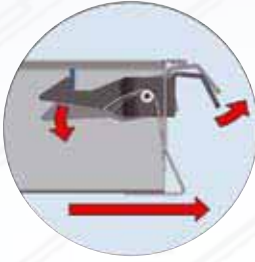

Central locking

- One central lock for all drawers and doors
- Safe and easy handling

Ball-bearing drawer slides

- The ball-bearing drawer slides ensure safe and easy sliding of the drawers, even when loaded to full capacity
- Full extension improves access

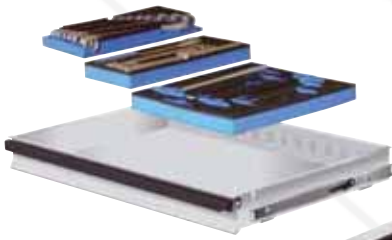

Load capacity

- The load capacity of the drawers is 40 kg
- The combined weight of our two mechanics' tool sets, S 1004 M and S 1007 M, is 40 kg
- One drawer could hold the full weight of all 250 tools!
- Models 2003, 2004, 2005, 1502, 1504, 1504 XL: The bottom drawer is designed as heavy-duty drawer, load capacity 60 kg



Square perforation 9 x 33 mm

- The square perforation in the side walls enable quick access to frequently used tools
- GEDORE holders and trays are simply clipped in

Heel protection

- All-round heel protection by rounded edges on the underside allows the tool trolley or workbench to be safely pulled or pushed

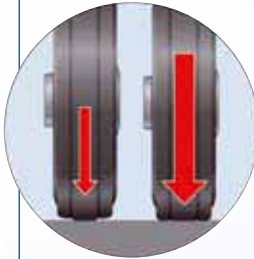
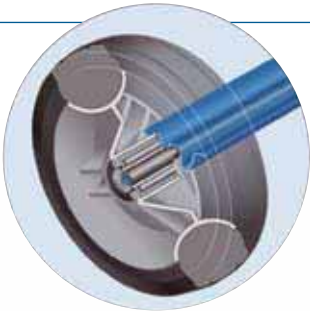

Smooth running and high-performance wheels

- The GEDORE smooth running and high-performance wheels keep, even under maximum load, the following features: Smooth running, track-keeping and manoeuvrability!

The GEDORE chassis

- The trapezoidal GEDORE chassis uniformly distributes the applied forces.
- The axle is mounted on triple bearings and is securely connected to the trapezoid.
- The third, central bearing prevents the axle bending under load.
- The special axle design ensures that the GEDORE high-performance rollers always roll on the full faces of their treads.
- Even under full load, the rollers retain their smooth running properties and cannot shed their tyres.
- Vertical and horizontal forces are absorbed by the positive-fit trapezoidal design.

Total braking system

- Prevents unwanted movement and turning of the wheel
- Ensures safe parking of the tool trolley or workbench

Impact protection

- The vertical or horizontal impact protection protects the tool trolley and anything it comes into contact with from damage
- It also protects other equipment in the workshop or vehicles from inadvertent contact

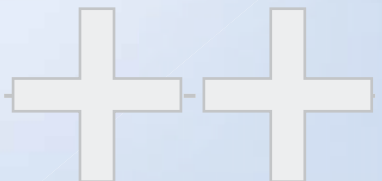

Powder coating

- GEDORIT blue and GEDORIT silver are the short names for the two types of powder paint, specially developed for GEDORE
- This coating method guarantees a high level of corrosion protection, combined with tough scratch resistance
- Powder coating is kind on the environment. Unused powder is reclaimed in the plant. No solvent is used
- Special colours available on request

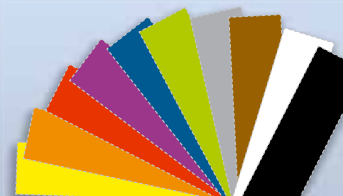
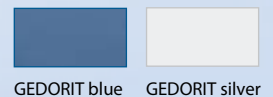













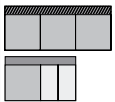

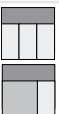

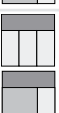

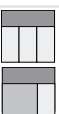

+ SELECTION AID - TOOL TROLLEYS

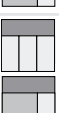
Type / Pattern	Trolley body					Chassis				Drawers					
	Load capacity (kg)	Central locking system	ABS working platform with compartments/protective edge	Impact protection	for car boot transportation	Wide-track chassis / heavy-duty (S)	GEDORE heavy-duty wheels	2x fixed castors (mm)	2x swivel castors (mm) incl. 1x total brake	Number	extendable to both sides	Max. load capacity per drawer (kg)	Single safeguard	fully extendable	Drawer volume Compatibility - modules
2005 500	●	●	●	●		S	●	200	125	6 - 10		40/60	●	●	
2004 500	●	●	●	●		S	●	200	125	5 - 10		40/60	●	●	
2003 500	●	●	●	●		S	●	200	125	7		40/60	●	●	
3000 400	●	●	●	●		B	●	200	125	7		40	●	●	
2545 330	●	●	●	●			●	200	125	7		35	●	●	
2525 330	●	●	●	●			●	140	100	7		40	●	●	
2535 250	●	●	●	●	●		●	140	100	4 plus large capacity drawer		22	●	●	
1585 300	●			●	●		●	140	100	6		40	●	●	
3010 120/220	●			●	●		●	140	100	3 plus large capacity drawer	●	22			
2000 300	●			●		B	●	140	100	5 plus large capacity drawer	●	22			
2500 300	●			●		B	●	140	100	8		40	●	●	
1580 300	●			●			●	140	100	4 plus large capacity drawer	●	22			
1578 200	●			●			●	140	100	6	●	22			

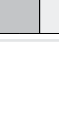

+ SELECTION AID - WORK BENCHES

Type / Pattern	Body							Storage space			Drawers				
	Height (mm)	with chassis - mobile	Mobile load capacity (kg)	Static load capacity (kg)	Central locking system	Wooden worktop (mm)	Heel protection edge	Wide-track chassis / heavy-duty (S)	Storage compartment with door/ storage compartment open (o)	including the back	Number	Max. load capacity per drawer (kg)	Single safeguard	fully extendable	Drawer volume Compatibility - modules
MOBILE															
1505 	900	●	500	1000	●	40	●	S	●		5	40	●		
1504 XL 	985	●	500	700	●	30	●	S	●		7 (6+1XL)	40/60	●	●	
1504 	985	●	500	700	●	30	●	S	●		6 - 10	40/60	●	●	
BR 1504 	985	●	500	700	●	30	●	S	●	●	7	40/60	●	●	
1502 	870	●	500	700	●	25	●		(o) open		6	40	●	●	
STATIONARY															
BR 1500 LH 	900			1000	●	40	●		●	●	5	40	●	●	
B 1500 L 	900			1000	●	40	●		●		5	40	●	●	
B1510 	840			250	●	40					0 - 4	35	●	●	
B1511 	840			250	●	40					0 - 4	35	●	●	
B 1525 	810			500			●								

**ES modules****CT modules**

85 - 93



2005

TOOL TROLLEY

- ✔ Working platform in ABS with 3 compartments for small parts
- ✔ With handle for easy pushing, pulling and turning
- ✔ Wide drawers (W 640 x D 400 mm)
- ✔ Drawers fully extendable, removable
- ✔ Single-hand operation with safety locking which prevents the drawers from opening when in motion
- ✔ Ball bearings
- ✔ Drawers individually partitionable, delivery includes length- (LD) and crosswise dividers (CD), see table
- ✔ Please order distance module 1500 ED-70 XL for fixing the modules
- ✔ Bottom drawer designed as heavy-duty drawer
- ✔ Load capacity per drawer 40 kg, bottom heavy-duty drawer 60 kg
- ✔ Both side walls with square perforation to fix torque wrenches or other long tools and accessories
- ✔ Central locking with cylinder lock
- ✔ Heel protection and all-round impact protection
- ✔ GEDORE heavy-duty chassis with high-performance wheels on roller bearings, with 2 fixed castors Ø 200 mm and 2 swivel castors Ø 125 mm, one with total brake
- ✔ Total load capacity 500 kg
- ✔ Dimensions: H 985 x W 775 x D 435 mm
- ✔ In GEDORIT blue, drawers GEDORIT silver, top black
- ✔ Delivery without tools and accessories
- ✔ Optional accessories: Tool chest 2430, rear panel R 2004 L or RB 2004 L, Wood plate 2004 HP

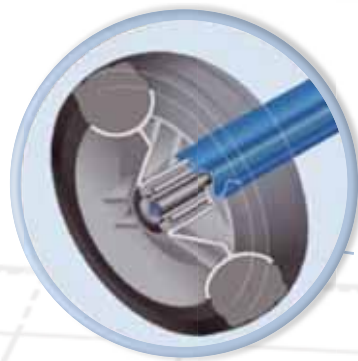

Code	No.		LD	CD	H	W	D	
1803018	2005 0511	5x type 1, H = 67 mm 1x type 2, H = 137 mm 1x type 3, H = 207 mm	10x	2x	985	775	435	93.0
2003546	2005 0321	3x type 1, H = 67 mm 2x type 2, H = 137 mm 1x type 3, H = 207 mm	6x	2x	985	775	435	89.0
2003554	2005 0701	7x type 1, H = 67 mm 2x type 2, H = 137 mm 1x type 3, H = 207 mm	10x	2x	985	775	435	92.0
2003562	2005 0810	8x type 1, H = 67 mm 1x type 2, H = 137 mm	15x	3x	985	775	435	99.0

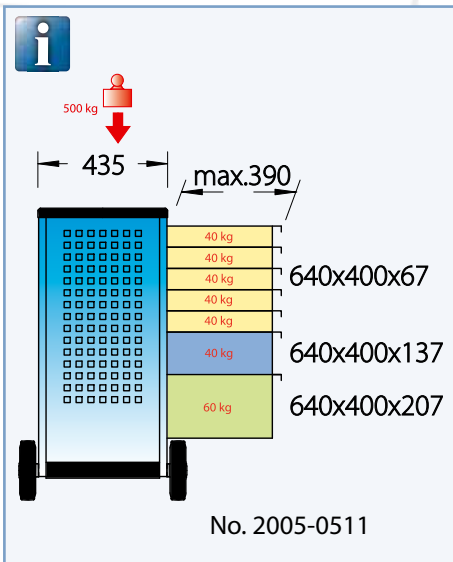

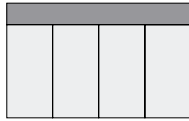
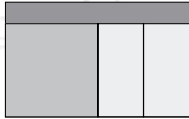
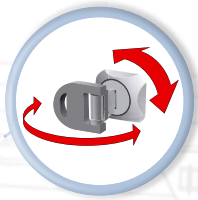

Optional accessories

➔ 2004 HP



31



➔ 1500 ES • 1500 CT



85
-
93

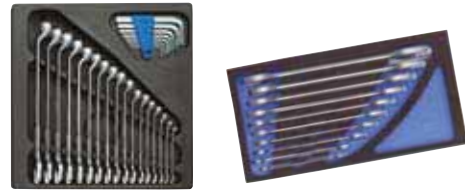

➔ 2430



30



➔ RB 2004 L



31

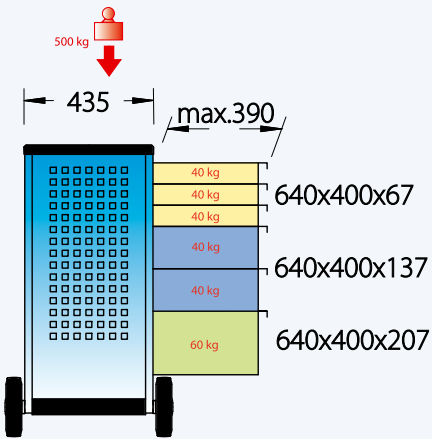

No. 2005-0321

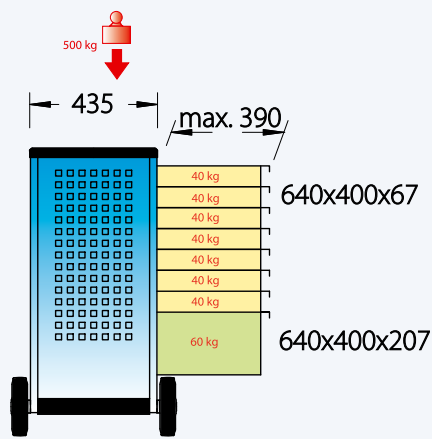

No. 2005-0701

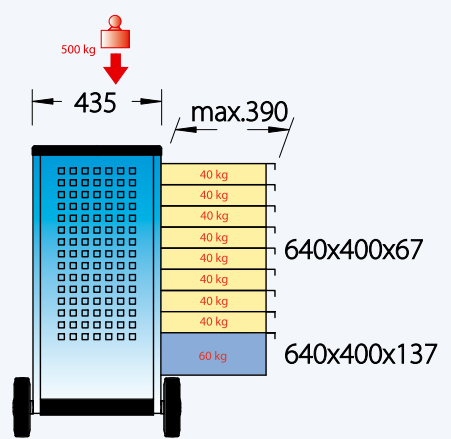

No. 2005-0810



2004

TOOL TROLLEY

- ✔ Working platform in ABS with 3 compartments for small parts
- ✔ With handle for easy pushing, pulling and turning
- ✔ Drawers fully extendable, removable
- ✔ Single-hand operation with safety locking which prevents the drawers from opening when in motion
- ✔ Ball bearings
- ✔ Drawers individually partitionable, delivery includes length- (LD) and crosswise dividers (CD), see table
- ✔ Bottom drawer designed as heavy-duty drawer
- ✔ Load capacity per drawer 40 kg, bottom heavy-duty drawer 60 kg (apart from 2004 1000)
- ✔ Storage compartment on the handle side with perforated sheet 9 x 33 mm to fix accessories
- ✔ Compartment door lockable with central locking
- ✔ Four removable drawers for small parts
- ✔ Central locking with cylinder lock
- ✔ Heel protection and all-round impact protection
- ✔ GEDORE heavy-duty chassis with high-performance wheels on roller bearings, with 2 fixed castors Ø 200 mm and 2 swivel castors Ø 125 mm, one with total brake
- ✔ Total load capacity 500 kg
- ✔ Dimensions: H 985 x W 775 x D 435 mm
- ✔ In GEDORIT blue, drawers GEDORIT silver, top black
- ✔ Delivery without tools and accessories
- ✔ Optional accessories: Tool chest 2430, Rear panel R 2004 L or RB 2004 L, Wood plate 2004 HP

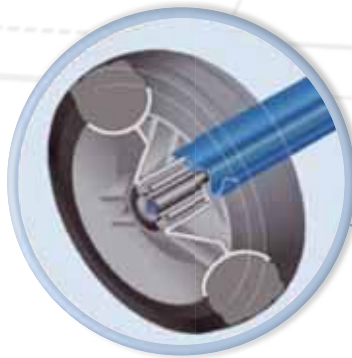
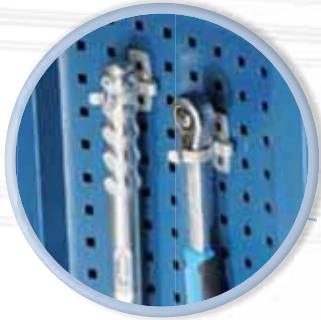

Code	No.		LD	CD	H	W	D	↕
1640690	2004 1000	10x type 1, H = 67 mm	15x	3x	985	775	435	94.0
1640704	2004 0810	8x type 1, H = 67 mm 1x type 2, H = 137 mm	15x	3x	985	775	435	91.0
1640712	2004 0701	7x type 1, H = 67 mm 1x type 3, H = 207 mm	10x	2x	985	775	435	86.0
1640720	2004 0620	6x type 1, H = 67 mm 2x type 2, H = 137 mm	10x	2x	985	775	435	88.0
1640739	2004 0511	5x type 1, H = 67 mm 1x type 2, H = 137 mm 1x type 3, H = 207 mm	10x	2x	985	775	435	84.0
1640755	2004 0321	3x type 1, H = 67 mm 2x type 2, H = 137 mm 1x type 3, H = 207 mm	6x	2x	985	775	435	82.0
1640763	2004 0131	1x type 1, H = 67 mm 3x type 2, H = 137 mm 1x type 3, H = 207 mm	3x	2x	985	775	435	75.0

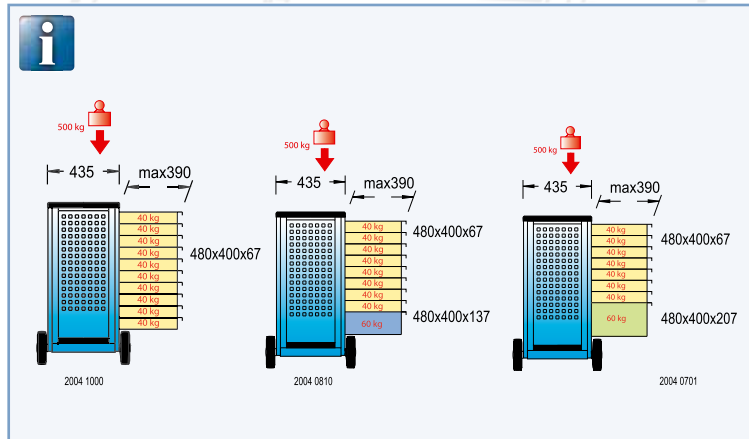

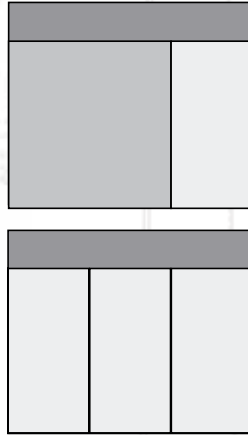
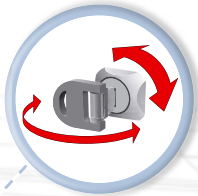

Optional accessories

➔ **2004 HP**

31



➔ **R 2004 L**

31



➔ **2430**

30



➔ **1500 ES**

85 - 89



➔ **1500 BL**

41

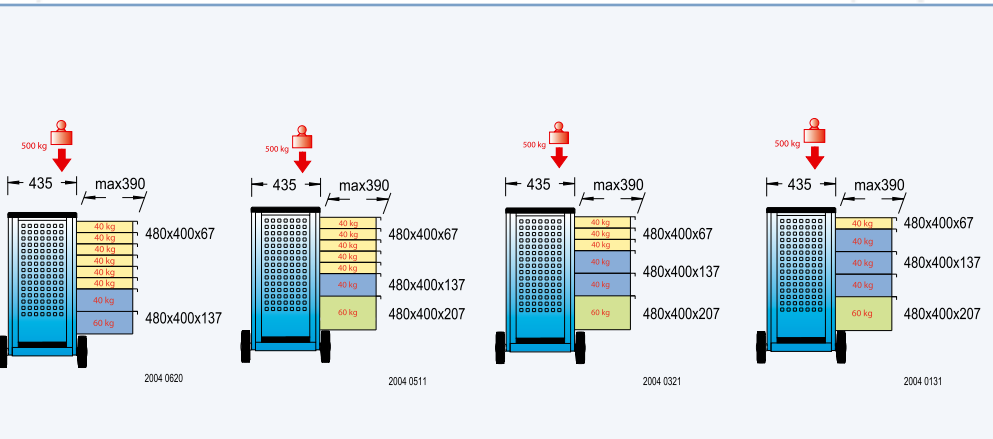



2003

TOOL TROLLEY with 7 drawers

- ✔ Working platform in ABS with 3 compartments for small parts
- ✔ With handle for easy pushing, pulling and turning
- ✔ Drawers fully extendable, removable
- ✔ Single-hand safety locking
- ✔ Ball bearings
- ✔ Drawers individually partitionable, delivery includes 10 length- and 2 crosswise dividers
- ✔ Supplied 2 distance modules 1500 ED-70 K
- ✔ Bottom drawer designed as heavy-duty drawer
- ✔ Load capacity per drawer 40 kg, bottom heavy-duty drawer 60 kg
- ✔ Storage compartment on the handle side with perforated sheet 9 x 33 mm to fix accessories
- ✔ Compartment door lockable with central locking
- ✔ Four removable drawers for small parts
- ✔ Central locking with cylinder lock
- ✔ Heel protection and all-round impact protection
- ✔ GEDORE heavy-duty chassis with high-performance wheels on roller bearings, with 2 fixed castors Ø 200 mm and 2 swivel castors Ø 125 mm, one with total brake
- ✔ Total load capacity 500 kg
- ✔ Dimensions: H 985 x W 775 x D 435 mm
- ✔ In GEDORIT blue, drawers GEDORIT silver, top black
- ✔ Delivery without tools
- ✔ Optional accessories: Tool chest 2430, Rear panel R 2004 L or RB 2004 L, Wood plate 2004 HP

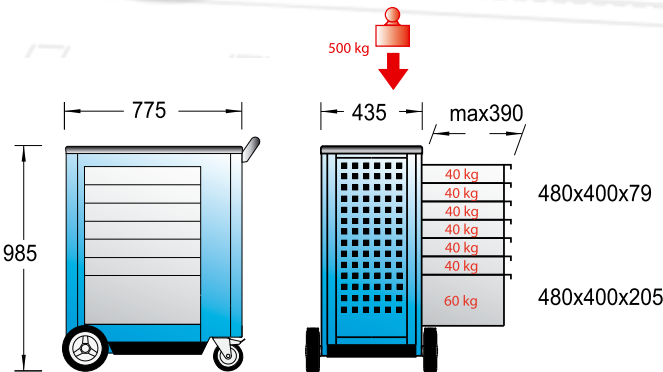
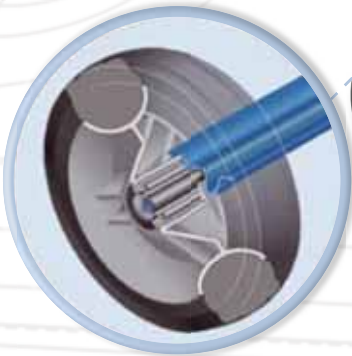
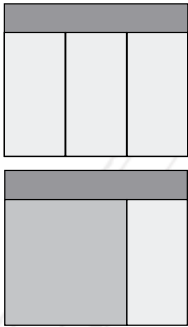
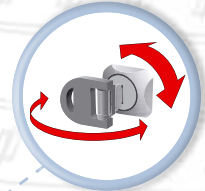

Code	No.	H	W	D	Wt
6630930	2003	985	775	435	82.0



3000

TOOL TROLLEY TANTO with 7 drawers

- ✔ Ideal for the utility vehicle sector
- ✔ Strong and manoeuvrable - rear axle steering ensures dynamic steering properties
- ✔ Can be turned on the spot, easily maneuverable, especially in narrow corridors
- ✔ Working platform in ABS with 4 compartments for incidental parts
- ✔ Drawers fully extendable, removable, ball bearings
- ✔ Drawers 1-6 individually partitionable, delivery includes 8 length- and 2 crosswise dividers and 2 anti-slip mats
- ✔ Single-hand operation with safety locking which prevents the drawers from opening when in motion
- ✔ Load capacity per drawer 40 kg
- ✔ Large capacity drawer for bulky parts
- ✔ Deep rear shelf with perforated wall 9 x 33 mm to fix accessories
- ✔ Central locking for padlock
- ✔ With heel protection and safety shock absorber
- ✔ GEDORE wide-track chassis with heavy-duty wheels on roller bearings, with 2 fixed castors Ø 200 mm and 2 swivel castors Ø 125 mm, one with total brake
- ✔ Total load capacity 400 kg
- ✔ Dimensions: H 920 x W 585 x D 485 mm
- ✔ In GEDORIT blue, drawers GEDORIT silver, top black
- ✔ Delivery without tools
- ✔ Optional accessories: Tool set S 1022, door element 1500 H 14, modules 1500 ES + CT, trays and much more besides

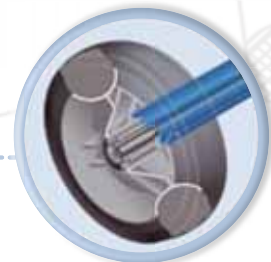
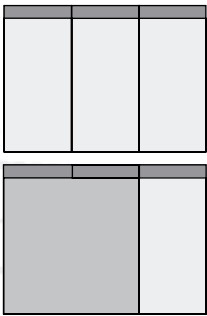
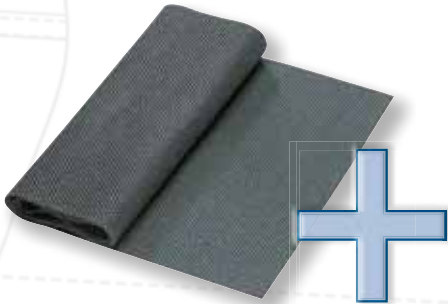

Code	No.	H	W	D	
6624880	3000	920	585	485	67.0

Optional accessories

1500 CT

90 - 93

1500 H 9

43

1500 H 14

31



2545 - 2546 - 2550

TOOL TROLLEY AND TOOL CHEST

2545 Tool trolley

- ✔ Working platform in ABS with 4 compartments for small parts
- ✔ With handle for easy pushing, pulling and turning
- ✔ 7 drawers fully extendable
- ✔ Single-hand operation with safety locking which prevents the drawers from opening when in motion
- ✔ Drawers individually partitionable, delivery includes 10 length- and 2 crosswise dividers
- ✔ Load capacity per drawer 35 kg
- ✔ 3 perforated side walls to fit with accessories
- ✔ Rear side with space for storage
- ✔ Central locking with cylinder lock
- ✔ With heel protection and vertical impact protection
- ✔ GEDORE heavy-duty chassis with high-performance wheels on roller bearings, with 2 fixed castors Ø 200 mm and 2 swivel castors Ø 125 mm, one with total brake
- ✔ Total load capacity 330 kg
- ✔ Dimensions: H 955 x W 705 x D 485 mm
- ✔ In GEDORIT blue, drawers GEDORIT silver, top black

2546 Tool chest

- ✔ Ribbed bottom lining
- ✔ 4 drawers fully extendable
- ✔ Drawers individually partitionable, delivery includes 6 length- and 2 crosswise dividers
- ✔ Roomy storage compartment with document partition
- ✔ Pneumatic soft opening and closing of lid
- ✔ Total load capacity 120 kg
- ✔ Dimensions: H 495 x W 705 x D 485 mm
- ✔ In GEDORIT blue, drawers GEDORIT silver, top black
- ✔ Delivery without tools

- ✔ **2550** consisting of tool trolley 2545 and tool chest 2546

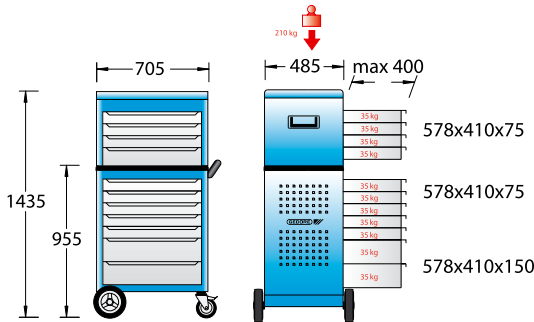
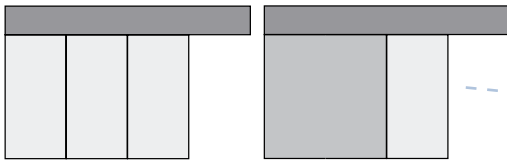

No. 2550

Code	No.	Description	LD	CD	H	W	D	↕
1942980	2545	Tool trolley with 7 drawers	10x	2x	955	705	485	77.0
1942999	2546	Tool chest with 4 drawers	6x	2x	495	705	485	45.0
1942972	2550	Tool trolley with tool chest	16x	4x	1435	705	485	122.0

Optional accessories

<p>➔ 1500 CT</p> <p>90 - 93</p>	<p>➔ 1500 ES</p> <p>85 - 89</p>	<p>➔ 2525 HP</p> <p>31</p>
<p>➔ 1500 H</p> <p>42 - 45</p>	<p>➔ 1500 H 13</p> <p>41</p>	<p>➔ 1500 H 9 • H 10</p> <p>43</p>



2525-520

TOOL TROLLEY with 7 drawers

- Working platform in ABS with 3 compartments for small parts
- With handle for easy pushing, pulling and turning
- Drawers fully extendable, removable, 1-5 individually partitionable
- Delivery includes 8 length- and 2 crosswise dividers
- Single-hand operation with safety locking which prevents the drawers from opening when in motion
- Load capacity per drawer 40 kg
- 2 perforated side walls, mounted inwards to fit with accessories
- Delivery includes tray for small parts and 10-piece hook assortment
- Central locking with cylinder lock
- With heel protection, sides with vertical impact protection
- GEDORE chassis with high-performance wheels on roller bearings, with 2 fixed castors Ø 140 mm and 2 swivel castors Ø 100 mm, one with total brake
- Total load capacity 330 kg
- Dimensions: H 965 x W 720 x D 395 mm
- In GEDORIT blue, drawers GEDORIT silver, top black
- Delivery without tools
- Optional accessory: Wood plate no. 2525 HP

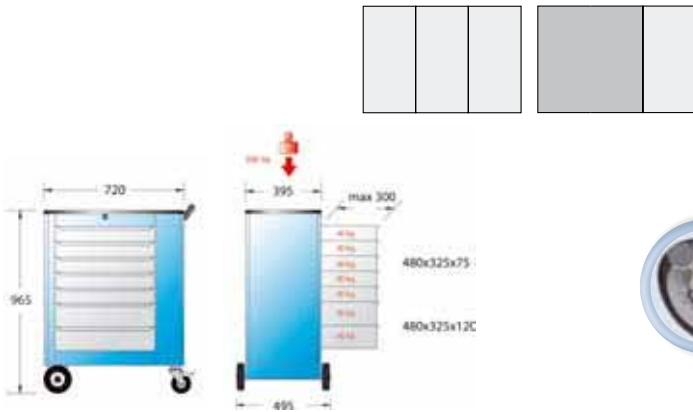

Code	No.	H	W	D	
1587102	2525-520	965	720	395	67.0



2535

TOOL TROLLEY DUO with 4 drawers

- Working platform in ABS with 3 compartments for small parts
- Drawers fully extendable, removable
- Single-hand operation with safety locking which prevents the drawers from opening when in motion
- Drawers individually partitionable, delivery includes length- (LD) and crosswise dividers (CD), see table
- Load capacity per drawer 40 kg
- Large storage compartment
- Separate locking for top and bottom of mobile toolchest with two identical cylinder locks
- Top and bottom of mobile toolchest joined by quick-action latches for easy separation. Top and bottom each with two carry handles
- With heel protection, sides with vertical impact protection
- GEDORE chassis with high-performance wheels on roller bearings, with 2 fixed castors Ø 140 mm and 2 swivel castors Ø 100 mm, one with total brake
- Total load capacity 330 kg
- Dimensions: H 930 x W 630 x D 390 mm
- In GEDORIT blue, drawers GEDORIT silver, top black
- Delivery without tools

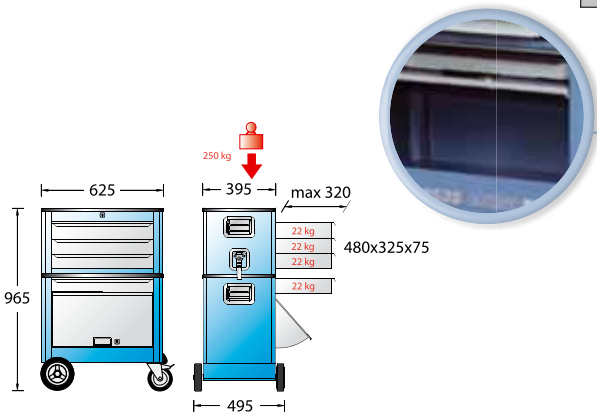

Code	No.	LD	CD	H	W	D	
1892495	2535	4x	2x	965	625	395	50.0
1906445	2535 SMA	3x	2x	350	625	395	27.0
1904167	2535 SMW	1x	-	635	625	395	23.0



No. 2535



1585

3-CHEST TOOL TROLLEY MODULAR SYSTEM

- ✔ When tool chests 1430 and 1431 are stacked on it, the base 1432 becomes the mobile high-capacity trolley 1585
- ✔ The base 1432 can of course also be combined with various tool chests, e.g. 1433-1072 ES
- ✔ With plug-in lockable push handle, also suitable for lifting the trolley
- ✔ A perforated metal sheet at the handle permits equipping the trolley with tools or parts for installation
- ✔ 1432 with ribbed bottom lining, central locking for padlock
- ✔ Drawers fully extendable, with single-hand safety locking
- ✔ Load capacity per drawer 40 kg
- ✔ With heel and impact protection
- ✔ GEDORE chassis with high-performance wheels on roller bearings, with 2 fixed castors Ø 140 mm and 2 swivel castors Ø 100 mm, one with total brake
- ✔ Total load capacity 300 kg
- ✔ Dimensions: H 1060 x W 660 x D 400 mm
- ✔ In GEDORIT blue, drawers GEDORIT silver, top black
- ✔ Delivery without tools



No. 1585
(No. 1430 + 1431 + 1432)



No. 1432 + 1430



No. 1432

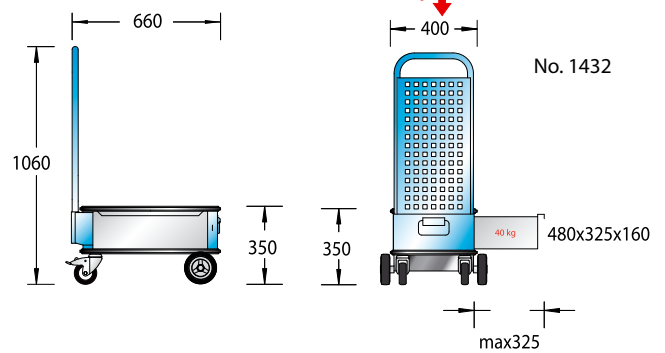
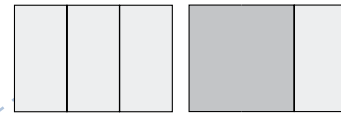

No. 1432

Code	No.	Description	H	W	D	LD	CD	CD	CD
6624290	1585	3-Chest tool trolley without tools	1060	660	400	8x	4x	64.0	
6618130	1430	Tool chest with 3 drawers	305	625	400	6x	2x	26.0	
6615030	1431	Tool chest with 2 drawers	305	625	400	2x	2x	23.0	
6615620	1432	Tool chest with mobile base	1060	660	400	-	-	24.0	
5801550	1582 HG	Hook assortment, 20 pieces						0.7	

Optional accessories

➔ **1433**

30

➔ **1500 CT**

90 - 93

➔ **1500 H 13**

41



3010

TOOL TROLLEY VARIO with lowering mechanism

- Working platform with ribbed bottom lining
- Lowering mechanism with single-button operation
- Drawers open either side
- Ball bearings, with middle and end catches
- Drawers individually partitionable, delivery includes 6 length- and 2 crosswise dividers
- Load capacity per drawer 22 kg
- Central locking when lowered, secured by padlock
- Heel protection and all-round impact protection
- GEDORE chassis with high-performance wheels on roller bearings, with 2 fixed castors Ø 140 mm and 2 swivel castors Ø 100 mm, one with total brake
- Lifts automatically with up to 25 kg load
- Automatic lock, to produce a sturdy working surface with over 120 kg load capacity
- When lowered, total load capacity over 220 kg
- Dimensions: H 900 x W 625 x D 400 mm
- In GEDORIT blue, drawers GEDORIT silver, top black
- Delivery without tools

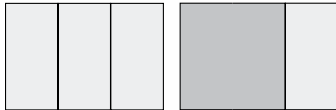

MAX

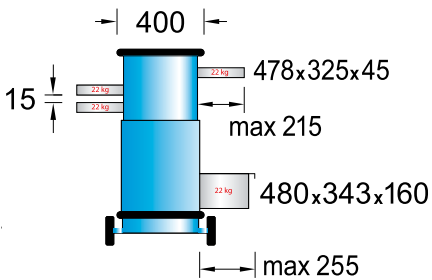
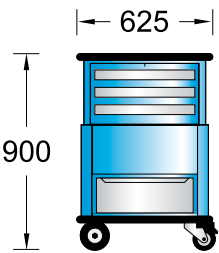

MIN

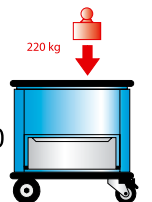

Code	No.	H	W	D	
6625260	3010	900	625	400	42.0





2000

TOOL TROLLEY with 5 drawers

- ✔ Working platform with ribbed bottom lining
- ✔ With handle for easy pushing, pulling and turning
- ✔ Drawers open either side, ball bearing catches, with middle and end catches
- ✔ Drawers individually partitionable, delivery includes 10 length- and 2 crosswise dividers
- ✔ Load capacity per drawer 22 kg
- ✔ Double sided metal shutters to secure the whole internal space
- ✔ Central locking with cylinder lock
- ✔ Heel protection and all-round impact protection
- ✔ GEDORE wide-track chassis with high-performance wheels on roller bearings, with 2 fixed castors Ø 140 mm and 2 swivel castors Ø 100 mm, one with total brake
- ✔ Trapezoid shape for extra stability, wheels mounted internally
- ✔ Total load capacity 300 kg
- ✔ Dimensions: H 930 x W 625 x D 400/545 mm
- ✔ In GEDORIT blue, drawers GEDORIT silver, top black
- ✔ Optional accessories: Top tool chests 1430, 1431, 1433-1072 ES, Wood plate 2000 HP

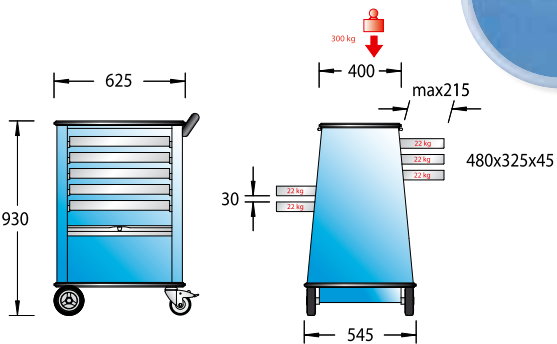
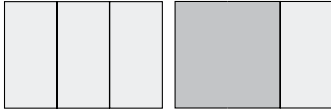

Code	No.	H	W	D ₁	D ₂	Wt
6627710	2000	930	625	400	545	47.0



2500

TOOL TROLLEY with 8 drawers

- ✔ Working platform with ribbed bottom lining
- ✔ With handle for easy pushing, pulling and turning
- ✔ Drawers fully extendable, removable, ball-catch bearings, with middle and end catches
- ✔ Single-hand safety locking
- ✔ Drawers individually partitionable, delivery includes 10 length- and 2 crosswise dividers
- ✔ Load capacity per drawer 40 kg
- ✔ Central locking with cylinder lock
- ✔ Heel protection and all-round impact protection
- ✔ GEDORE wide-track chassis with high-performance wheels on roller bearings, with 2 fixed castors Ø 140 mm and 2 swivel castors Ø 100 mm, one with total brake
- ✔ Trapezoid shape for extra stability, wheels mounted internally
- ✔ Total load capacity 300 kg
- ✔ Dimensions: H 960 x W 625 x D 400/545 mm
- ✔ Optional accessories: Top tool chests 1430, 1431, 1433-1072 ES, Wood plate 2000 HP

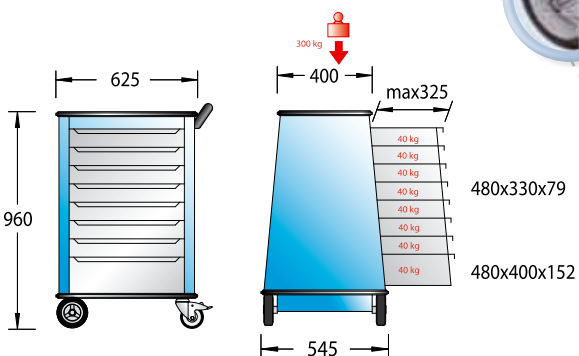

Code	No.	H	W	D ₁	D ₂	Wt
6171720	2500	960	625	400	545	64.0



**1580****TOOL TROLLEY with 4 drawers**

- Working platform with ribbed bottom lining
- With handle for easy pushing, pulling and turning
- Drawers open either side
- Ball bearings, with middle and end catches
- Drawers individually partitionable, delivery includes 8 length- and 2 crosswise dividers
- Load capacity per drawer 22 kg
- Deep storage at base
- Both sides with square perforation
- Central locking with cylinder lock
- Double sided metal shutters to secure the whole internal space
- Heel protection and all-round impact protection
- GEDORE chassis with high-performance wheels on roller bearings, with 2 fixed castors Ø 140 mm and 2 swivel castors Ø 100 mm, one with total brake
- Total load capacity 300 kg
- Dimensions: H 930 x W 625 x D 400 mm
- In GEDORIT blue, drawers GEDORIT silver, top black
- Delivery without tools
- Optional accessories: Top tool chests 1430, 1431, 1433-1072 ES, Wood plate 2000 HP, Additional drawer KSF 1580

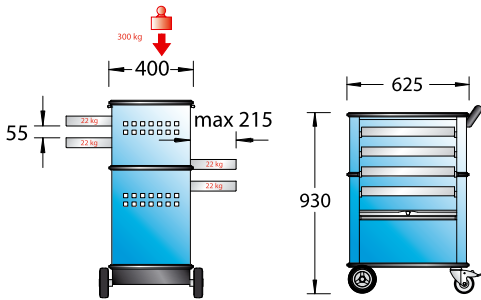
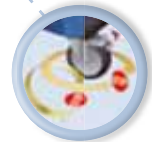
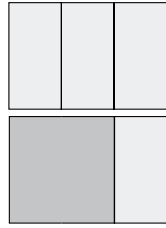

480x325x45

Code	No.	H	W	D	⚖️
6627550	1580	930	625	400	40.0

1578**TOOL TROLLEY with 6 drawers**

- Working platform in ABS with 3 compartments for small parts
- With handle for easy pushing, pulling and turning
- Drawers open either side
- Drawers individually partitionable, delivery includes 6 length- and 2 crosswise dividers
- Load capacity per drawer 22 kg
- Central locking with cylinder lock
- With heel protection
- GEDORE chassis with high-performance wheels on roller bearings, with 2 fixed castors Ø 140 mm and 2 swivel castors Ø 100 mm, one with total brake
- Total load capacity 200 kg
- Dimensions: H 930 x W 605 x D 375 mm
- In GEDORIT blue, drawers GEDORIT silver, top black

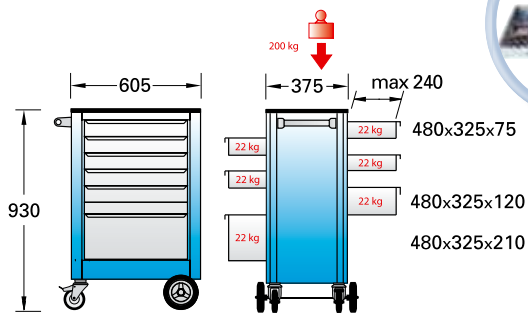
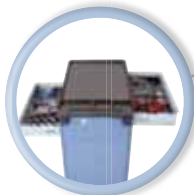
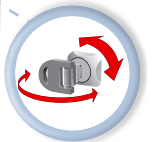
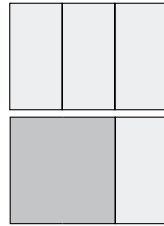

Code	No.	H	W	D	⚖️
9018140	1578	930	605	375	43.5

Optional accessories**KSF 1580**

31

2000 HP

31

1430 • 1431

30



TOP TOOL CHESTS

1430

TOOL CHEST

- Designed particularly as top box for trolleys 1580, 1585, 2000, 2500, 3010
- With three partitionable drawers, supplied with 6 lengthwise and 2 crosswise dividers
- Drawers run smoothly on guides with ball bearings fully extendable
- Load capacity per drawer 40 kg
- Central locking with hasp for padlock
- Rubber mat, and rubber protection around the edge
- In GEDORIT blue, drawers GEDORIT silver
- Dimensions: H 305 x W 625 x D 400 mm

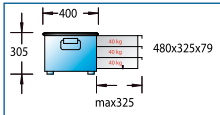
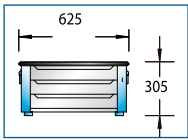

Code	No.	H	W	D	Weight
6618130	1430	305	625	400	26.0

1431

TOOL CHEST

- Designed particularly as top box for trolleys 1580, 1585, 2000, 2500, 3010
- With 2 drawers, drawers run smoothly on guides with ball bearings, fully extendable
- One partitionable drawer, supplied with 2 lengthwise and 2 crosswise dividers
- Load capacity per drawer 40 kg
- Central locking with hasp for padlock
- Rubber mat, and rubber protection around the edge
- In GEDORIT blue, drawers GEDORIT silver
- Dimensions: H 305 x W 625 x D 400 mm

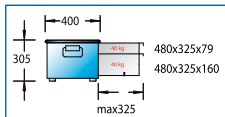
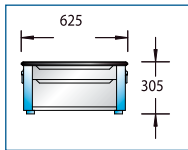

Code	No.	H	W	D	Weight
6615030	1431	305	625	400	23.0

2430

TOOL CHEST

- Designed particularly as top box for trolleys 2003, 2004, 2005
- Working platform in ABS with 3 compartments for small parts
- Three drawers individually partitionable, delivery includes 6 length- and 2 crosswise dividers
- Each drawer suitable to take 4 pieces of 1/3 tool modules no. 1500 ES / 1500 CT
- Drawer size: W 640 x D 400 x H 67 mm
- Drawers fully extendable, removable
- Single-hand operation with safety locking which prevents the drawers from opening when in motion
- Load capacity per drawer 40 kg
- Central locking with cylinder lock
- In GEDORIT blue, drawers GEDORIT silver
- Dimensions: H 345 x W 775 x D 435 mm
- Optional accessory: Wood plate no. 2004 HP

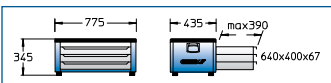

Code	No.	H	W	D	Weight
1888927	2430	345	775	435	23.0

2546

TOOL CHEST

- Ribbed bottom lining
- Four drawers fully extendable
- Drawers individually partitionable, delivery includes 6 length- and 2 crosswise dividers
- Load capacity per drawer 35 kg
- Roomy storage compartment with document partition
- Pneumatic soft opening and closing of lid
- Total load capacity 120 kg
- Dimensions: H 495 x W 705 x D 485 mm
- In GEDORIT blue, drawers GEDORIT silver, top black

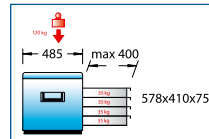
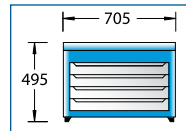

Code	No.	H	W	D	Weight	Quantity
1942999	2546	495	705	485	45.0	1

1433-1072 ES

TOOL CHEST for mobile use

- Tool chest 1433 L including 3 modular tool boxes 1072 ES-1500 L
- Open at front, central locking with turnlock fastener for a padlock
- Particularly suitable for use in combination with chassis 1432 for mobile use
- In GEDORIT blue
- Dimensions: H 310 x W 605 x D 375 mm

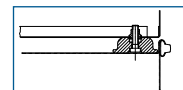
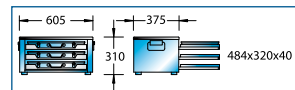

Code	No.	H	W	D	Weight
1482483	1433-1072 ES	310	605	375	20.4
6627200	1433 L	310	605	375	16.0

1072 ES

TOOL MODULE EMPTY

- For tool modules 1500 ES
- May be individually equipped with two or three tool modules
- Foam rubber firmly glued to lid
- Suitable as spare part in tool chest 1433 L
- Sturdy sheet steel, in GEDORIT blue
- Dimensions: W 478 x D 313 x H 70 mm
- Delivery without tools



Code	No.	W	D	H	Weight
6602990	1072 ES-1500 L	480	330	70	3.3

**1072 K****TOOL BOX**

- Sturdy sheet steel, in GEDORIT blue
- With deep-drawn plastic insert with 19 compartments
- Fits into tool chest 1433 L
- Dimensions: W 480 x D 330 x H 70 mm
- (Ill. similar)



Code	No.	W	D	H	
1920049	1072 K-19	480	330	70	3.6

R 2004 L**REAR PANEL**

- Can be attached to 2003, 2004, 2005
- The complete loaded rear wall can be simply lowered
- Automatically raised by two gas springs
- Neat arrangement of tools on square perforation 9 x 33 mm
- Central locking with cylinder lock
- Delivery without tools

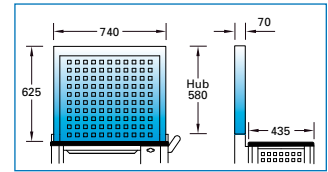

Code	No.	H	W	D	
1446169	R 2004 L	768	770	116	25.0

RB 2004 L**REAR PANEL**

- Can be attached to 2003, 2004 and 2005
- Square perforation 9 x 33 mm



Code	No.	H	W	D	
1933302	RB 2004 L	700	665	15	5.8

1500 H 14**DOOR ELEMENT for TANTO 3000**

- For later installation
- The free space in the rear can be enclosed with this and secured with the cylinder lock installed
- 3000 TANTO models from 1998 on are set up for this installation, assembly materials are supplied
- Suitable trays 1500 H 9-75 and 1500 H 10-75
- In GEDORIT silver
- Delivery without tools



Code	No.	
5809880	1500 H 14	5.9

ACCESSORIES FOR TOOL TROLLEYS**2004 HP****WOOD PLATE**

- Multiplex beech wood
- For tool trolleys 2003, 2004 and 2005 and tool chest 2430
- To fit in the plastic top, 30 mm thick, to get an additional work surface



Code	No.	mm	W	D	
1446967	2004 HP	30	590	410	5.0

2000 HP**WOOD PLATE**

- Multiplex beech wood
- For tool trolleys 1580, 1585, 2000, 2500, 3010, and tool chests 1430, 1431, 1433

Code	No.	mm	W	D	
1785567	2000 HP				

2525 HP**WOOD PLATE**

- Multiplex beech wood
- For tool trolley 2525
- To fit in the plastic top, 20 mm thick, to get an additional work surface

Code	No.	mm	W	D	
2082578	2525 HP	20	550	375	4.0

1500 H 7**TRAY**

- Will fit on 1580, 1585, 2000, 2500
- A useful tray to increase the working surface, captive coupling to the trolley
- Load capacity approx. 5 kg
- In GEDORIT blue with rubber mat

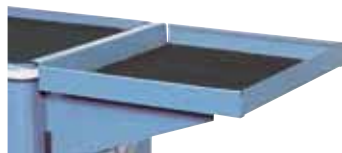

Code	No.	H	W	D		
5792030	1500 H 7	30	370	300	1.6	1

KSF 1580**ADDITIONAL DRAWER**

- Will fit the drawers of GEDORE tool trolley 1580
- With bearings, mounting pieces and mounting manual
- Up to 4 additional drawers can be fitted
- In GEDORIT silver



Code	No.	H	W	D	
6624610	KSF 1580	24	420	325	2.2

WORKBENCHES

1505

MOBILE WORKBENCH

- ✔ Ergonomic working height
- ✔ 40 mm thick multiplex beech wood worktop, surface additionally protected by linseed oil varnish
- ✔ Five drawers, extendable up to 505 mm, with single-hand safety locking
- ✔ Drawers individually partitionable, delivery includes 9 length- and 9 crosswise dividers as well as 2 distance modules no. 1500 ED-70 K
- ✔ Ball bearings
- ✔ Load capacity per drawer 40 kg
- ✔ Large, lockable cupboard with shelf
- ✔ Central locking with cylinder lock
- ✔ With heel protection
- ✔ GEDORE Jumbo heavy-duty chassis with independent wheel suspension - sturdy and mobile
- ✔ With hydraulic raising mechanism - just lift the pull handle
- ✔ High floor clearance for easy, safe movement and absolutely stable standing
- ✔ Static load capacity 1000 kg, 500 kg when mobile
- ✔ Dimensions: H 900 x W 1100 x D 652 mm
- ✔ Model S with vice no. 411-150
- ✔ In GEDORIT blue, drawers GEDORIT silver
- ✔ Delivery without tools
- ✔ Prepared for mounting rear panel no. R 1504 L

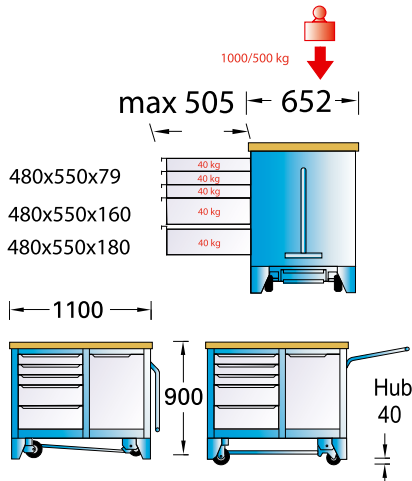
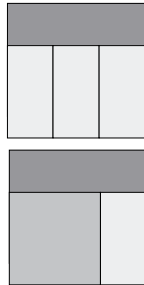
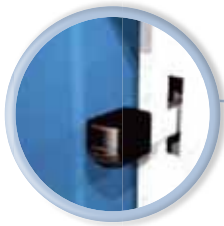

Code	No.	Description	mm [D]	H	W	D	Hub
6621780	1505	Mobile workbench	40	900	1100	652	138.0
6621860	1505 S	Mobile workbench with vice	40	900	1100	652	156.5

Optional accessories

<p>R 1504 L</p>	<p>38</p>	<p>1500 BL</p>	<p>41</p>	<p>1500 H 13</p>	<p>41</p>
<p>411-125</p>	<p>466</p>	<p>1500 H</p>	<p>42 - 45</p>	<p>1500 ES / CT</p>	<p>85 - 93</p>



1504 XL

MOBILE WORKBENCH EXTRA WIDTH

- 30 mm thick multiplex beech wood worktop, surface additionally protected by linseed oil varnish
- One extra large drawer for long tools or 6 tool modules (1/3 modules)
- Drawers fully extendable
- Single-hand operation with safety locking which prevents the drawers from opening when in motion
- Ball bearings
- Drawers individually partitionable, delivery includes 10 length- and 2 crosswise dividers
- Bottom drawer designed as heavy-duty drawer
- Load capacity per drawer 40 kg, bottom heavy-duty drawer 60 kg
- Large usable storage space with lockable door
- Central locking for cylinder lock
- With heel protection
- GEDORE heavy-duty chassis with high-performance wheels on roller bearings, with 2 fixed castors Ø 200 mm and 2 swivel castors Ø 125 mm with total brake
- Static load capacity 700 kg, 500 kg when mobile
- Dimensions: H 985 x W 1250 x D 550 mm
- In GEDORIT blue, drawers GEDORIT silver
- Delivery without tools
- Optional accessories: Rear panel R 1504 XL-L

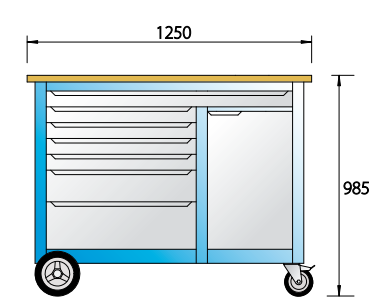
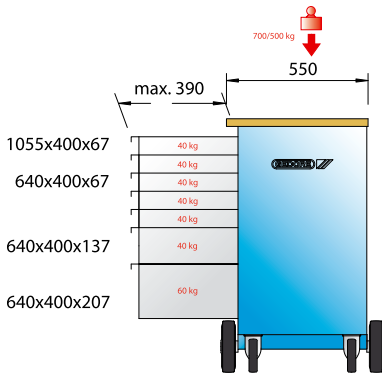
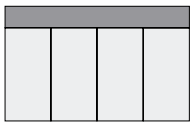
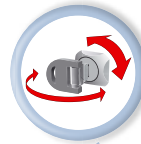
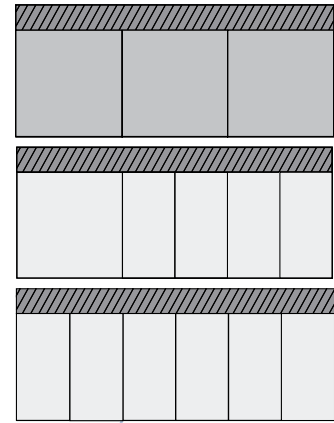

Code	No.	⊞	H	W	D	⊞
1988468	1504 XL	1x type XL, H = 67 mm, W = 1055 mm 4x type 1, H = 67 mm 1x type 2, H = 137 mm 1x type 3, H = 207 mm	985	1250	550	1200



R 1504 XL-L



38

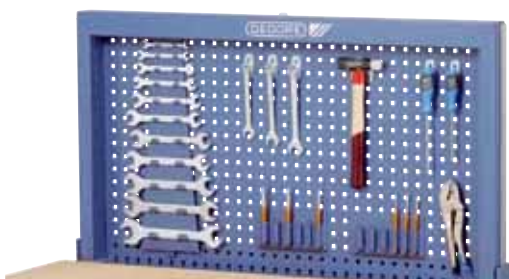



1504

MOBILE WORKBENCH

- ▶ 30 mm thick multiplex beech wood worktop, surface additionally protected by linseed oil varnish
- ▶ Five different drawer combinations
- ▶ Drawers fully extendable
- ▶ Single-hand operation with safety locking which prevents the drawers from opening when in motion
- ▶ Ball bearings
- ▶ Drawers individually partitionable, delivery includes length- (LD) and crosswise dividers (CD), see table, as well as 2 distance modules no. 1500 ED-70 K
- ▶ Bottom drawer designed as heavy-duty drawer
- ▶ Load capacity per drawer 40 kg, bottom heavy-duty drawer 60 kg (apart from 1504 1000)
- ▶ Large usable storage space with lockable door
- ▶ Central locking with cylinder lock
- ▶ With heel protection
- ▶ GEDORE heavy-duty chassis with high-performance wheels on roller bearings, with 2 fixed castors Ø 200 mm and 2 swivel castors Ø 125 mm with total brake
- ▶ Static load capacity 700 kg, 500 kg when mobile
- ▶ Dimensions: H 985 x W 1100 x D 550 mm
- ▶ Model S with vice no. 411-125
- ▶ In GEDORIT blue, drawers GEDORIT silver
- ▶ Delivery without tools
- ▶ Optional fold-down rear panel no. R 1504 L can be fitted

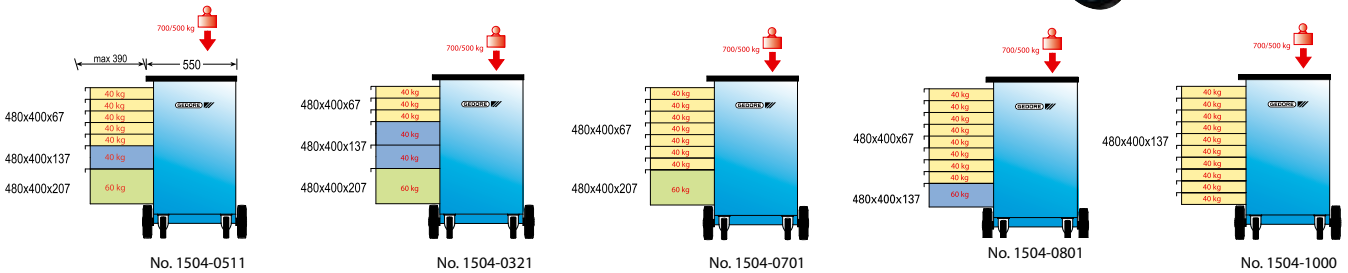
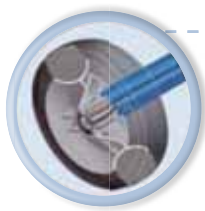
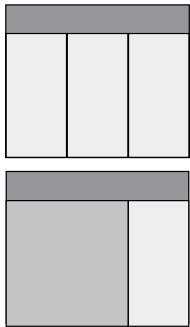

Code	No.	LD	CD	Description	mm	
6622830	1504 0511	5x type 1, H = 67 mm 1x type 2, H = 137 mm 1x type 3, H = 207 mm	10x	2x	Mobile workbench with 7 drawers	100.0
6623050	1504 0511 S	5x type 1, H = 67 mm 1x type 2, H = 137 mm 1x type 3, H = 207 mm	10x	2x	Mobile workbench with 7 drawers and vice	102.2
1814958	1504 0321	3x type 1, H = 67 mm 2x type 2, H = 137 mm 1x type 3, H = 207 mm	6x	2x	Mobile workbench with 6 drawers	96.0
1814931	1504 0701	7x type 1, H = 67 mm 1x type 3, H = 207 mm	10x	2x	Mobile workbench with 8 drawers	99.0
1814923	1504 0810	8x type 1, H = 67 mm 1x type 2, H = 137 mm	15x	3x	Mobile workbench with 9 drawers	106.0
1814915	1504 1000	10x type 1, H = 67 mm	15x	3x	Mobile workbench with 10 drawers	110.0

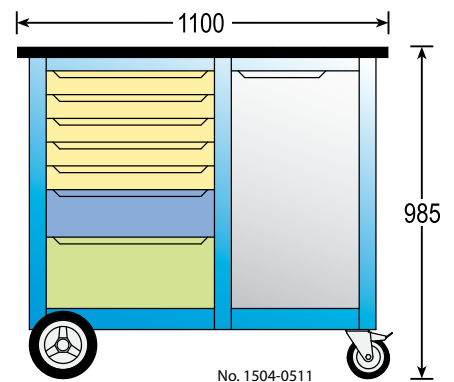

**BR 1504****MOBILE WORKBENCH with self raising rear panel**

- ✔ Multiplex beech wood worktop, surface additionally protected by linseed oil varnish
- ✔ Drawers fully extendable
- ✔ Single-hand operation with safety locking which prevents the drawers from opening when in motion
- ✔ Ball bearings
- ✔ Drawers individually partitionable, delivery includes 10 length- and 2 crosswise dividers as well as 2 distance modules no. 1500 ED-70 K
- ✔ Bottom drawer designed as heavy-duty drawer
- ✔ Load capacity per drawer 40 kg, bottom heavy-duty drawer 60 kg
- ✔ Large usable storage space with lockable door
- ✔ With installed rear panel R 1504
- ✔ Automatically raised by 2 gas springs
- ✔ The complete loaded rear wall can be simply lowered
- ✔ Central locking with cylinder lock
- ✔ With heel protection
- ✔ GEDORE heavy-duty chassis with high-performance wheels on roller bearings, with 2 fixed castors Ø 200 mm and 2 swivel castors Ø 125 mm with total brake
- ✔ Static load capacity 700 kg, 500 kg when mobile
- ✔ Dimensions: H 985 x W 1100 x D 550 mm
- ✔ Model LH with hook assortment no. 1504 HG
- ✔ Model S with vice no. 411-125
- ✔ In GEDORIT blue, drawers GEDORIT silver
- ✔ Delivery without tools

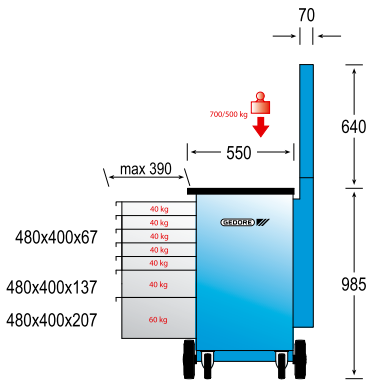
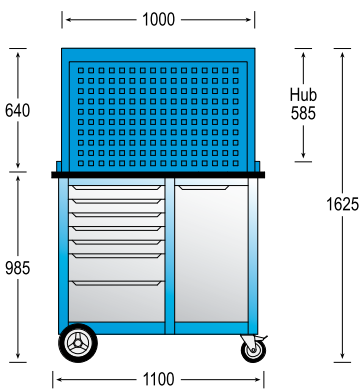

BR1504_0511

Code	No.	Description	mm	H	W	D	
6624450	BR 1504 0511 L	Workbench with rear panel	30	985	1100	550	128.0
6623990	BR 1504 0511 LH	Workbench with rear panel + hook assortment	30	985	1100	550	130.0
6624370	BR 1504 0511 S	Workbench with rear panel + vice	30	985	1100	550	130.0

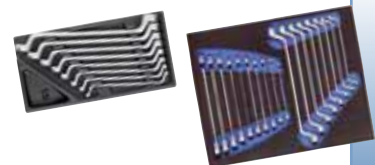
Optional accessories➔ **411-125****466**➔ **1500 BL****41**➔ **1500 ES / CT****85
-
93**



1502

MOBILE WORKBENCH

- ✔ 25 mm thick multiplex beech wood worktop, surface additionally protected by linseed oil varnish
- ✔ Six drawers fully extendable
- ✔ Single-hand safety locking
- ✔ Ball bearings
- ✔ Drawers individually partitionable, delivery includes 10 length- and 2 crosswise dividers as well as 2 distance modules no. 1500 ED-70 K
- ✔ Bottom drawer designed as heavy-duty drawer
- ✔ Load capacity per drawer 40 kg, bottom heavy-duty drawer 60 kg
- ✔ Large, easily-accessible spaces for bulky parts
- ✔ Central locking with cylinder lock
- ✔ With heel protection
- ✔ GEDORE heavy-duty chassis with high-performance wheels on roller bearings, with 2 fixed castors Ø 200 mm and 2 swivel castors Ø 125 mm with total brake
- ✔ Static load capacity 700 kg, 500 kg when mobile
- ✔ Dimensions: H 875 x W 950 x D 550 mm
- ✔ Model S with vice no. 409
- ✔ In GEDORIT blue, drawers GEDORIT silver
- ✔ Delivery without tools

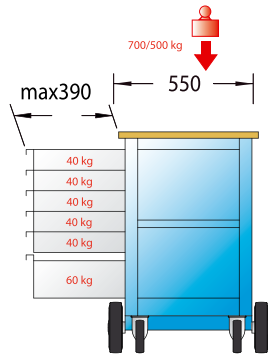
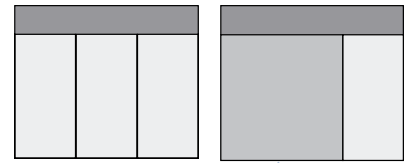

480x400x79

480x400x180



Code	No.	Description	mm	H	W	D	W
6620540	1502	Mobile workbench	25	875	950	550	78.0
6620620	1502 S	Mobile workbench with vice	25	875	950	550	85.0





BR 1500 LH

WORKBENCH WITH TOOL CABINET

B 1500 L

- 40 mm thick multiplex beech wood worktop, surface additionally protected by linseed oil varnish
- Five drawers, extendable up to 505 mm, individually partitionable, delivery includes 9 length- and 9 crosswise dividers
- Drawers removable
- Load capacity per drawer 40 kg
- Open space for storage, secured with strong metal shutter
- Separate locking of drawers and shutter by cylinder locks
- With heel protection
- Total load capacity 2000 kg
- Dimensions: H 900 x W 2000 x D 875 mm
- In GEDORIT blue, drawers GEDORIT silver

R 1500 LH

- Sheet steel construction
- With metal shutter lockable by cylinder lock
- Perforated rear to take fittings for any choice of assortment
- With hook assortment 1500 HS 23
- Dimensions: H 890 x W 1810 x D 170 mm
- In GEDORIT blue, shutter GEDORIT silver

➤ **BR 1500 LH** Consisting of workbench B 1500 L and tool cabinet R 1500 LH

➤ Delivery without tools

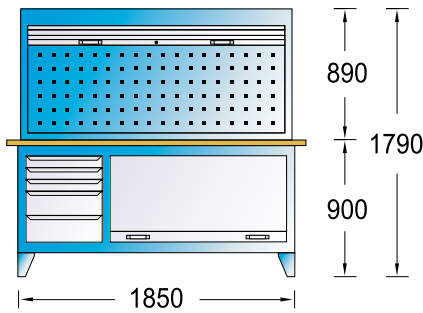
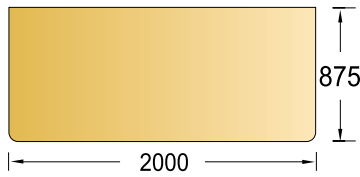
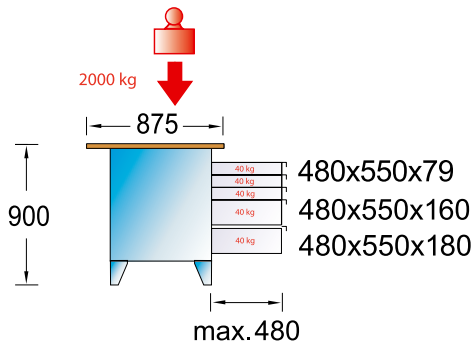

No. BR 1500 LH

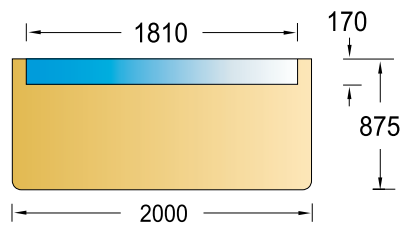

Code	No.	mm	H	W	D	
6618210	BR 1500 LH	40	1790	2000	875	203.7
6618050	B 1500 L	40	900	2000	875	166.0

R 1500 L



40





ACCESSORIES FOR WORKBENCHES

R 1504 L

REAR PANEL

- ✔ Can be attached to workbench 1504 or 1505
- ✔ Automatically raised by two gas springs, lockable with cylinder lock
- ✔ Neat arrangement of tools
- ✔ Dimensions: H 640 x W 1000 x D 70 mm
- ✔ Execution LH with hook assortment No. 1504 HG
- ✔ GEDORIT blue

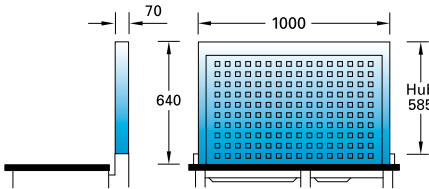

Code	No.	Description	H	W	D	mm
6623800	R 1504 L	Rear panel empty, 640x1000x70 mm	640	1000	70	28.0
6624020	R 1504 LH	Rear panel empty with hook assortment, 640x1000x70 mm	640	1000	70	21.0

www.gedore.com

R 1504 XL-L

REAR PANEL

- ✔ Can be attached to workbench 1504 XL
- ✔ Automatically raised by two gas springs, lockable with cylinder lock
- ✔ Neat arrangement of tools
- ✔ Dimensions: W 1190 x D 70 mm
- ✔ GEDORIT blue
- ✔ Execution LH with hook assortment No. 1504 HG

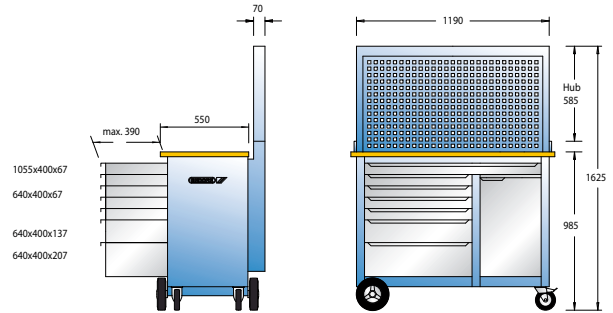

1504XL-0511 + R1504XL

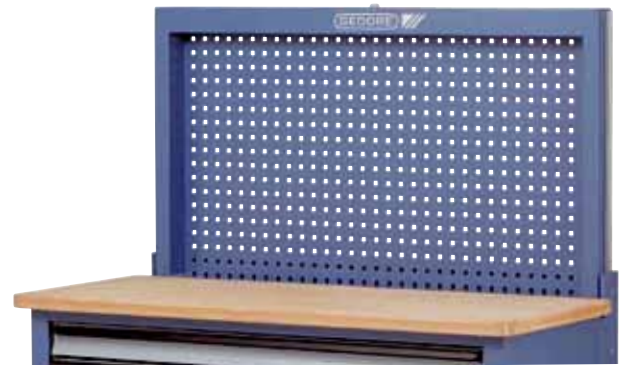

Code	No.	Description	H	W	D	mm
2251787	R 1504 XL-L	Rear panel empty, 640x1190x70 mm	640	1190	70	
2251795	R 1504 XL-LH	Rear panel empty with hook assortment, 640x1190x70 mm	640	1190	70	

FOLDING WORKBENCH

B 1525

FOLDING WORKBENCH

- ✔ Stable hinged workbench, needs little space when folded
- ✔ Strong beech wood worktop with zinc-plated steel edge protector - corrosion resistant
- ✔ Base made from steel tube, in GEDORIT blue
- ✔ Load capacity 500 kg
- ✔ Dimensions: H 810 x W 1000 x D 700 mm

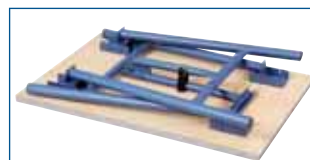
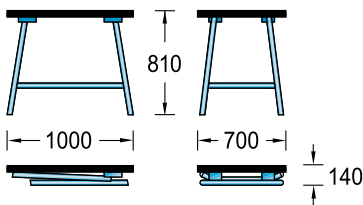

Code	No.	mm	H	W	D	mm
6622910	B 1525	30	810	1000	700	32.0



WORKBENCHES SELF-ASSEMBLY RANGE

B 1510 - B 1511

WORKBENCH WITH DRAWER CABINET

- 40 mm thick multiplex beech wood worktop
- With 1 to 4 drawers, front panel height 90 mm
- Drawer dimensions: W 480 x D 535 x H 75 mm
- Drawers fully extendable, removable
- Individually partitionable, delivery includes length- and crosswise dividers
- Load capacity per drawer 35 kg
- Drawer cabinet can be mounted either right or left
- Central locking with cylinder lock
- Workbench stands made from U-steel section and includes floor mounting plate
- Load capacity 250 kg evenly distributed
- In GEDORIT blue, drawers GEDORIT silver
- Delivery disassembled, for self-assembly, mounting material included
- Dimensions: **B 1510**: H 840 x W 1500 x D 700 mm / **B 1511**: H 840 x W 2000 x D 700 mm

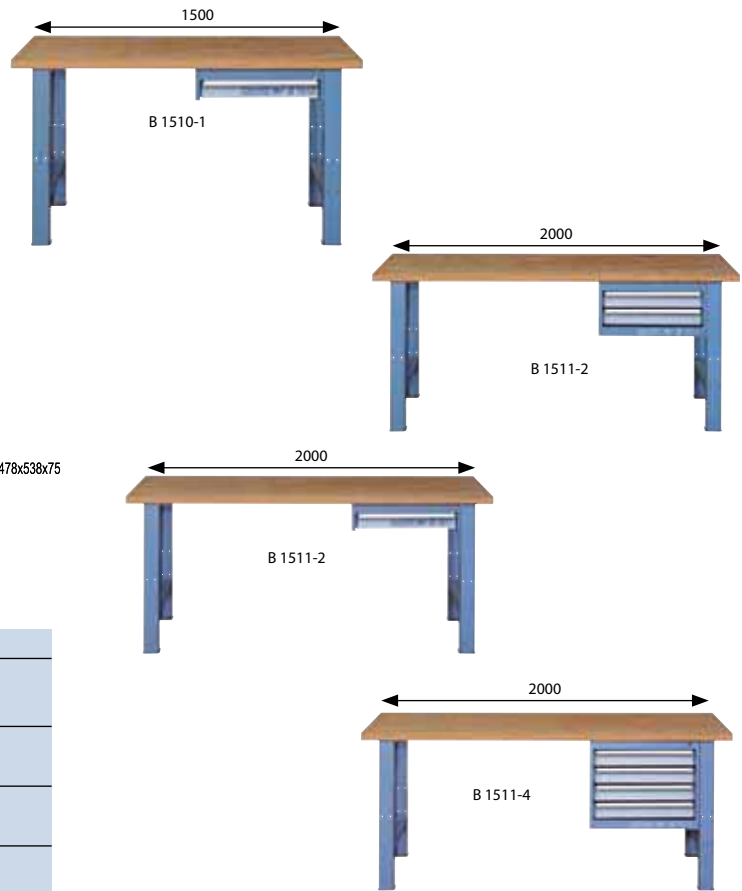
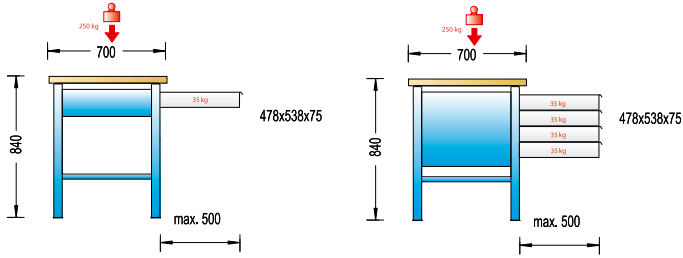

Code	No.	Execution	H	W	D	↕
1955713	B 1510-1	1 90	840	1500	700	59.0
1955764	B 1511-1	1 90	840	2000	700	69.0
1955772	B 1511-2	2 90	840	2000	700	78.0
1955799	B 1511-4	4 90	840	2000	700	96.0

DRAWER CABINETS

1405

DRAWER CABINET

- Drawers fully extendable
- With mechanical interlock system that allows only one drawer to open at a time
- Drawer size inside: 612 x 612 mm
- Central locking with cylinder lock
- Dimensions: H 1000 x W 697 x D 695 mm
- In GEDORIT blue, drawers GEDORIT silver



1405-5

1405-7



1405-8

1405-10

Code	No.	Execution	H	W	D	↕
1958224	1405-5	5 3x 150 2x 225	1000	697	695	88.0
1958232	1405-7	7 3x 75 3x 150 1x 225	1000	697	695	100.0
1958240	1405-8	8 4x 75 4x 150	1000	697	695	106.0
1958259	1405-10	10 8x 75 2x 150	1000	697	695	118.0

TOOL CABINETS

1400

TOOL CABINET

- ✔ Sturdy sheet steel construction with storage and three drawers
- ✔ With fittings for tool assortment S 1400
- ✔ Including loose modules 1500 E-1993 L and 1500 E-19 L
- ✔ With cylinder lock
- ✔ In GEDORIT blue, drawers GEDORIT silver
- ✔ Dimensions: H 970 x W 650 x D 250 mm





Code	No.	Compilation	H	W	D	
6612600	1400 L	Cabinet empty	970	650	250	33.0
6613250	1400 GM	Cabinet 1400 L + assortment S 1400 GM	970	650	250	46.7
6613330	1400 GZM	Cabinet 1400 L + assortments S 1400 GM + ZM	970	650	250	57.4
6613410	1400 GA	Cabinet 1400 L + assortment S 1400 GA	970	650	250	46.6

1401

TOOL CABINET

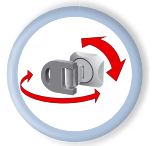
- ✔ Sturdy sheet steel construction with perforated lining for any individual arrangement
- ✔ With storage and three drawers
- ✔ With loose modules 1500 E-1993 L and 1500 E-19 L
- ✔ With cylinder lock
- ✔ In GEDORIT blue, drawers GEDORIT silver
- ✔ Dimensions: H 970 x W 650 x D 250 mm



Code	No.	Compilation	H	W	D	
5610610	1401 L	Cabinet empty	970	650	250	39.0
6611550	1401 LH	Cabinet 1401 L + hook assortment 1500 HS 11	970	650	250	34.0
6611630	1401 GM	Cabinet 1401 L + hook assortment 1500 HS 11 + assortment S 1400 GM	970	650	250	48.0
6611710	1401 GZM	Cabinet 1401 L + hook assortment 1500 HS 11 + assortments S 1400 GM + ZM	970	650	250	58.0
6611980	1401 GA	Cabinet 1401 L + hook assortment 1500 HS 11 + assortment S 1400 GA	970	650	250	47.0

R 1500 L

TOOL CABINET

- ✔ Suitable as workbench top
- ✔ Sheet steel construction
- ✔ With metal shutter lockable by cylinder lock
- ✔ Perforated rear to take fittings for any choice of assortment
- ✔ Model LH with hook assortment no. 1500 HS 23
- ✔ Dimensions: H 890 x W 1810 x D 170 mm
- ✔ In GEDORIT blue, shutter GEDORIT silver
- ✔ Delivery without tools



Code	No.	H	W	D	
6617910	R 1500 L	890	1810	170	78.0
6619100	R 1500 LH	890	1810	170	81.2





B 1500 L





37



B 1450 LH / LHG



79
-
81

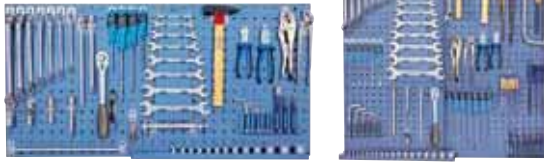

ACCESSORIES TOOL TROLLEYS / WORKBENCHES

1500 BL

LIGHT STRIP FOR TOOL TROLLEYS

- Light strip to provide ideal illumination of drawers, particularly on GEDORE tool trolleys
- A magnetic strip securely attaches the lighting to the trolley body
- Positioned above the drawers, the ten powerful LEDs illuminate the opened drawers
- This makes it easier to locate the right tool in dark or low lighting conditions, preventing the risk of cuts from chisels, knives or saw blade
- The light strip is also suitable for use on folding back panels and tool chests
- Easy battery change (three AAA batteries)
- LED technology for low power consumption and long life
- DBGM (German utility patent)
- The light strip can be used with the following GEDORE products: 2004, 2005, 2430, 2500, 3010, 2525, 2545, 2546, 2550, 2535, 3000, 1504, 1502, 1504 XL, R 1504, 1505, B 1500, R 1500, B 1510-1 to -4, 1405, 1400, 1401



Code	No.	(mm)	↕
2247542	1500 BL	430	280

1500 H 13

ANTI-SLIP MAT Products sold by the metre

- For all drawers in GEDORE tool trolleys and workbenches
- Various areas of application: Workshop, household, car, spare time...
- Enormous slip resistance on many different surfaces
- Can be cut to size
- Resistant to temperatures from -30°C to +100°C
- Melting point approx. +250°C
- Flame resistant
- Resistant to chemicals
- Shock- and noise absorbing
- Dimensions: W 475 x L 2000 mm



Code	No.	↕
5790250	1500 H 13	540

1500 H 15

WRITING SUPPORT

- For all GEDORE tool trolleys and workbenches
- Height adjustable with one swift movement
- Inclination adjustable, 4 x 90° swivel mounted for individual positioning
- Very robust for neat writing
- Keeps the working surface free
- Writing surface 310 x 400 mm
- Easy extendable, mounting material included in delivery
- Delivery without decoration

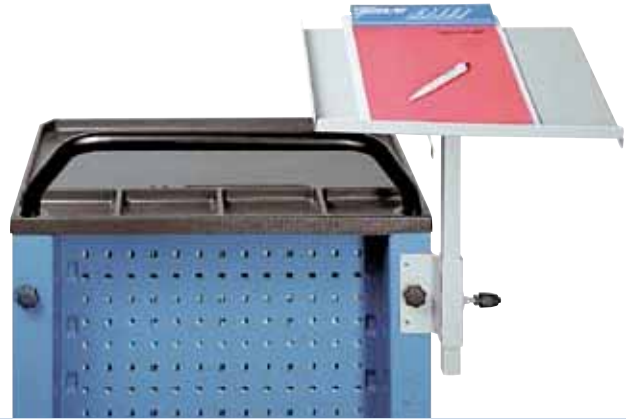

Code	No.	↕
5806860	1500 H 15	3.9

1500 H 16

SMALL-PARTS DRAWER FOR TOOL TROLLEYS

- To place on top of existing drawers of tool trolleys, additional surface to place small parts
- Suitable for tool trolleys and workbenches in combination with modules 1500 ES: 2003, 2500, 3000, B 1500, 1502, 1504, 1505
- Suitable for tool trolleys and workbenches without using modules 1500 ES: 1580, 2000, 3010
- Tool trolley 2004: suitable for drawer height 137 and 207 mm, for 67 mm not in combination with 1500 ES
- Delivery without decoration



Code	No.	↕
1761129	1500 H 16	644





E-1500 - E-3000

LENGTHWISE DIVIDER slotted

- ✔ In three different heights
- ✔ In seven different lengths for varying drawer depths
- ✔ In zinc-plated sheet steel

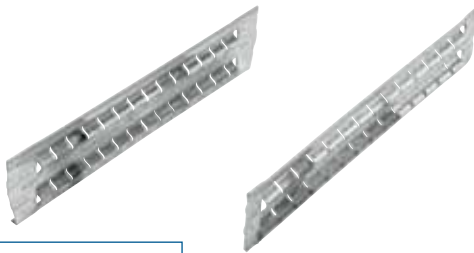

Code	No.	L	H	for use with	↕
5325840	E-1580/14	317	42	1580, 2000, 3010	136
5326570	E-2500/62	320	60	2500 (1-7), 1431 (1), 1430	190
5325920	E-3000/36	346	60	3000 (1-6)	204
1886932	E-2005 KL/42	395	60	2005, 1504 XL, 2430	235
5326490	E-1504 KL/57	397	60	1502 (1-5), 1504 (1-6), 2003 (1-6), 2004 (type 1)	208
2335239	E-2545/070	409	50	2545, 2546, 2550	200
5315880	E-B 1500/38	548	60	B 1500 (1-3), 1505 (1-3)	312

E-1580

CROSSWISE DIVIDER

- ✔ Usage: 1580, 2000, 3010
- ✔ In three different lengths, to fit the lengthwise dividers
- ✔ In zinc-plated sheet steel



Code	No.	L	H	↕
1394878	E-1580/11-40	40	40	12
5325760	E-1580/11-80	80	40	24
5326140	E-1580/11-120	120	40	36

E-2545 - E-3000

CROSSWISE DIVIDER

Usage:

- ✔ **E-3000:** 1430, 1431 (1), B 1500 (1-3), 1502 (1-5), 1504 (1-6), 1504 XL, 1505 (1-3), 2003 (1-6), 2004 (type 1), 2005 (type 1), 2430, 2500 (1-7), 3000
- ✔ **E-2545:** 2550 consisting of 2545 and 2546
- ✔ In zinc-plated sheet steel



Code	No.	L	H	↕
5326060	E-3000/37-80	80	55	35
5326220	E-3000/37-120	120	55	50
2335220	E-2545/99	99	50	100

TOOL HOLDERS / TOOL HOOKS

1500 H 0

TOOL HOOK straight mandrel

- ✔ Ø 4 mm especially suitable for GEDORE screwdrivers with hanging hole
- ✔ Suitable for perforated panels with square perforation 9 x 33 mm and 10 x 38 mm
- ✔ Chrome-plated



Code	No.	Ø	l-mm	↕	↔
5803410	1500 H 0-50	4	50	28	10

1500 H 1

TOOL HOOK inclined hook end

- ✔ Suitable for perforated panels with square perforation 9 x 33 mm and 10 x 38 mm
- ✔ Chrome-plated



Code	No.	Ø	l-mm	↕	↔
5803680	1500 H 1-50	4	50	28	10

1500 H 2 - 1500 H 3

SPRING CLAMP

- ✔ Suitable for perforated panels with square perforation 9 x 33 mm and 10 x 38 mm
- ✔ Chrome-plated



H2



H3

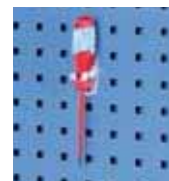

Code	No.	Ø	l-mm	↕	↔
2008351	1500 H 2-10	10	31	25	10
5803760	1500 H 2-13	13	31	26	10
2008378	1500 H 2-16	16	31	27	10
5803840	1500 H 3	20-35	44	28	10

**1500 H 4****BASE PLATE**

- With M6 thread for universal fixing
- Suitable for perforated panels with square perforation 9 x 33 mm and 10 x 38 mm
- Chrome-plated



Code	No.	W	H	D	Icons
1446185	1500 H 4	26	10		

1500 H 9**TRAY**

- A handy place to keep tools that are needed constantly
- 1500 H 9-75 can be fitted in connection with door element 1500 H 14



Code	No.	W	H	D	Icons
1446924	1500 H 9-75	456	50	75	854
5792540	1500 H 9-100	456	50	100	854

1500 H 5**PAPER ROLL HOLDER**

- Suitable for perforated panels with square perforation 9 x 33 mm and 10 x 38 mm



Code	No.	W	H	D	Icons
5798660	1500 H 5	250	6	94	1

1500 H 6**CABLE REEL HOOK**

- Suitable for perforated panels with square perforation 9 x 33 mm
- Delivery without decoration



Code	No.	W	H	D	Icons
5797850	1500 H 6	110	40	60	95 1

1500 H 8**HOLDER**

Code	No.	W	H	D	Icons
5792460	1500 H 8	456	5	150	

1500 H 10**TRAY**

- With four partitions, for often-needed small parts
- 1500 H 10-75 can be fitted in connection with door element 1500 H 14



Code	No.	W	H	D	Icons
1446932	1500 H 10-75	456	50	75	766
5792620	1500 H 10-100	456	50	100	840

3000 TANTO

23

1500 H 11**TRAY**

- With 4 plastic cases 1500 H-11/3, for holding larger quantities of working materials
- Cannot be fitted in connection with door element 1500 H 14



Code	No.	W	H	D	Icons
5792700	1500 H 11	456	55	95	655

1500 H 18**TOOL HOOK straight mandrel**

- Suitable for perforated panels with square perforation 9 x 33 mm and 10 x 38 mm
- Delivery without tools



Code	No.	Ø	W	H	D	Icons
2008386	1500 H 18-50	6	50	34	10	
2008394	1500 H 18-100	6	100	46	10	
2008408	1500 H 18-150	6	150	56	10	

1500 H 19**TOOL HOLDER double, straight mandrel**

- Suitable for perforated panels with square perforation 9 x 33 mm
- Delivery without tools



Code	No.	Ø	W	H	D	Icons
2008416	1500 H 19-50	6	50	74	5	
2008424	1500 H 19-100	6	100	98	5	
2008432	1500 H 19-150	6	150	118	5	





1500 H 20

- TOOL HOLDER vertical hook end**
- ✔ Suitable for perforated panels with square perforation 9 x 33 mm and 10 x 38 mm
 - ✔ Chrome-plated
 - ✔ Delivery without decoration

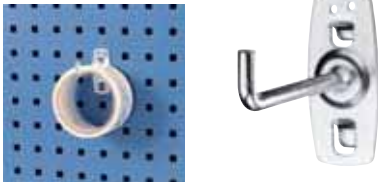

Code	No.	∅	H	D	∅
1879162	1500 H 20-35	6	35	34	10
2008440	1500 H 20-75	6	75	46	10
2008459	1500 H 20-135	6	135	56	10

1500 H 21

- TOOL HOLDER double, vertical hook end**
- ✔ For hammers and ratchets
 - ✔ Suitable for perforated panels with square perforation 9 x 33 mm
 - ✔ Chrome-plated
 - ✔ Delivery without tools

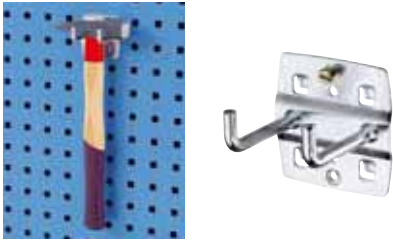

Code	No.	∅	H	D	∅
2008475	1500 H 21-35	6	35	76	5
1879170	1500 H 21-50	6	50	80	5
2008483	1500 H 21-75	6	75	90	5

1500 H 22

- TOOL HOLDER for pliers**
- ✔ Suitable for perforated panels with square perforation 9 x 33 mm
 - ✔ Chrome-plated
 - ✔ Delivery without tools

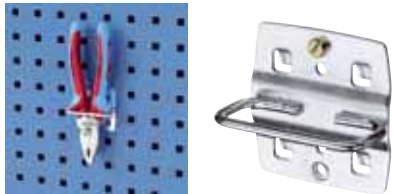

Code	No.	W	D	∅	∅
2008491	1500 H 22-35	35	20	62	5
1879189	1500 H 22-55	55	20	66	5
2008505	1500 H 22-75	75	20	68	5

1500 H 23

- MACHINE HOLDER FOR BATTERY SCREWDRIVER**
- ✔ Suitable for perforated panels with square perforation 9 x 33 mm
 - ✔ Chrome-plated
 - ✔ Delivery without tools

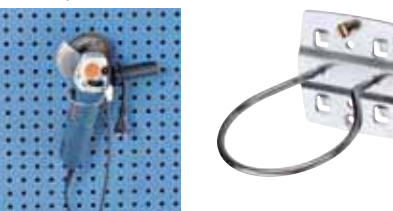

Code	No.	∅	H	∅
2008513	1500 H 23-40	40	68	5
1879197	1500 H 23-60	60	60	5
2008521	1500 H 23-80	80	80	5

1500 H 24

- TOOL HOLDER for screwdrivers**
- ✔ Suitable for perforated panels with square perforation 9 x 33 mm
 - ✔ Chrome-plated
 - ✔ Delivery without tools

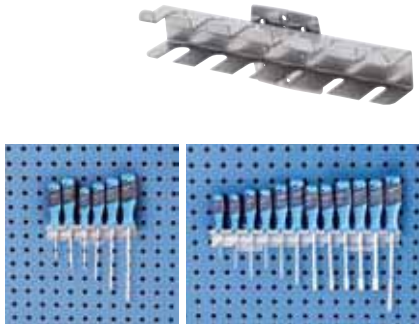

Code	No.	Execution	∅	∅
1879200	1500 H 24-6	for 6 pieces	100	1
2008548	1500 H 24-12	for 12 pieces	400	1

1500 H 25

- TOOL HOLDER for 3 cans**
- ✔ Suitable for perforated panels with square perforation 9 x 33 mm
 - ✔ Chrome-plated
 - ✔ Delivery without decoration



Code	No.	∅	W	H	∅
2008556	1500 H 25-1	70	100	200	1
1879219	1500 H 25-3	70	300	600	1

1500 H 26

- MOUNTING RAIL FOR STORAGE BOXES**
- ✔ Suitable for perforated panels with square perforation 9 x 33 mm
 - ✔ No. 1500 H 26-1 for one storage box (max. 105 mm wide)
 - ✔ No. 1500 H 26 for up to 4 storage boxes (depending on width)
 - ✔ Delivery without storage boxes



Code	No.	H	H	∅
2008564	1500 H 26-1	55	50	5
1933183	1500 H 26	495	418	1

1500 H 27

- SOCKET HOLDER**
- ✔ With 11 holes
 - ✔ Hole diameter 10x 25 mm and 1x 27.5 mm
 - ✔ Suitable for perforated panels with square perforation 9 x 33 mm
 - ✔ Delivery without tools



Code	No.	W	H	D	∅	∅
1920634	1500 H 27	352	60	54	500	1

1500 H 28

- SHELF**
- ✔ Suitable for perforated panels with square perforation 9 x 33 mm



Code	No.	W	H	D	∅	∅
1933191	1500 H 28	496	168	303	3000	1

1500 H 29

- TOOL HOOK inclined hook end**
- ✔ Suitable for perforated panels with square perforation 9 x 33 mm and 10 x 38 mm
 - ✔ Delivery without tools

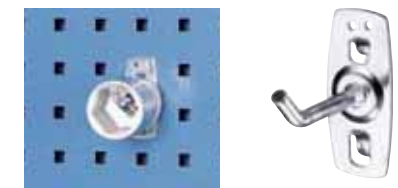

Code	No.	∅	H	D	∅
2008572	1500 H 29-50	6	50	34	10
2008580	1500 H 29-100	6	100	46	10





1500 H 30

TOOL HOOK for sockets

- Suitable for perforated panels with square perforation 9 x 33 mm and 10 x 38 mm

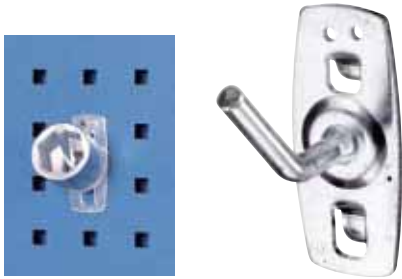

Code	No.	L ₁	L ₂	Ø	↳	↳
2008599	1500 H 30	15	40	6	34	10

1500 H 31

ROUND HOLDER

- Suitable for perforated panels with square perforation 9 x 33 mm
- Delivery without tools



Code	No.	W	L	↳	↳
2008602	1500 H 31	27	65	68	5

1500 H 32

SAW HOLDER

- Suitable for perforated panels with square perforation 9 x 33 mm
- For 4 saws. Please order in pairs!
- Delivery without tools



Code	No.	D	H	↳	↳
2008610	1500 H 32	80	52	86	1

1500 H 33

TUBE HOLDER

- Suitable for perforated panels with square perforation 9 x 33 mm
- Hook width 35 mm
- Delivery without decoration

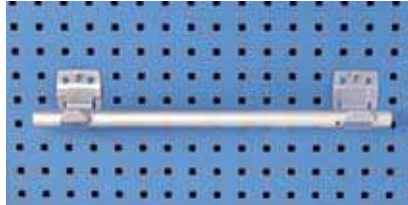

Code	No.	W	H	D	Ø	↳	↳
2008629	1500 H 33-60	58	67	74	60	114	1
2008637	1500 H 33-100	58	96	114	100	156	1

1500 H 34

DRILL-BIT HOLDER

- Suitable for perforated panels with square perforation 9 x 33 mm
- No. **1500 H 34-14** with 14 holes, diam.:
2 ea. 3.0 4.2 6.5 7.5 8.5 16.5 mm, 1 ea. 10.5 12.5 mm
- No. **1500 H 34-28** with 28 holes, diam.:
4 ea. 3.2 4.2 6.5 7.5 8.5 16.5 mm, 2 ea. 10.5 12.5 mm
- Delivery without tools

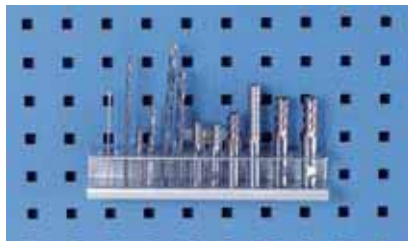

Code	No.	W	H	D	↳	↳
2008645	1500 H 34-14	200	60	37	200	1
2008653	1500 H 34-28	390	60	37	400	1

1500 H 35

HOLDER FOR ALLEN KEYS

- Suitable for perforated panels with square perforation 9 x 33 mm



Code	No.	W	H	↳	↳
2008661	1500 H 35	200	73	300	1

1500 H 36

TOOL HOLDER

- For customising (wooden plate)
- Suitable for perforated panels with square perforation 9 x 33 mm
- Delivery without tools



Code	No.	W	H	D	↳	↳
2008688	1500 H 36	340	55	135	1100	1

1500 H 37 - 1500 H 38

SPANNER HOLDER

- Suitable for perforated panels with square perforation 9 x 33 mm
- No. **1500 H 37**: for 8 spanners, suitable for no. 1 B, 2, 4, 6, 7, 7 R
- No. **1500 H 38**: for 10 spanners, suitable for no. 2, 6
- Delivery without tools



Code	No.	W	H	D	↳	↳
2008696	1500 H 37	124	66	145	220	1
1920626	1500 H 38	75-147	227	60	400	1



VH 1

TOOL HOLDER EMPTY for 8 spanners

- With handle, transport safety device (anti-theft device) and self-service suspension
- Suitable for the sets 1 B-080, 4-8, 6-8, and 7-080 as well for 7 R and 7 UR
- Delivery without tools



Code	No.	W	H	D	Icon 1	Icon 2
1465147	VH 1				74	1



WVH 1

TOOL HOLDER EMPTY for 8 spanners

- Can be fixed firmly to various wall types, e.g. EURO-perforation panels, GEDORE perforation panels, wooden and stone walls
- Includes base support WH 1, tool holder VH 1 and two distance washers for fixing to wooden walls
- Suitable for the sets 1 B-080, 4-8, 6-8, and 7-080 as well as 7 R and 7 UR
- Delivery without tools



Code	No.	Description	W	H	D	Icon 1	Icon 2
1465120	WVH 1	Wall holder complete, empty				276	1
1465155	WH 1	Base support				116	1
1476386	WH 1 S	Base support with distance washers				160	1
1465171	E-WVH 1/4	Distance washers for WVH 1				20	1

VS 19 H

TOOL TRAY

- For sockets
- Dimensions: W 570 x D 25-45 mm
- In sheet steel, GEDORIT blue



Code	No.	W	D	W	H	D	Icon 1	Icon 2
5152640	VS 19 H	570	25-45	550				1

VS 245 H

CHISEL HOLDER EMPTY

- For 6 chisels
- Dimensions: W 195 x H 95 x D 22 mm
- In sheet steel, GEDORIT blue



Code	No.	W	H	D	W	H	D	Icon 1	Icon 2
5456270	VS 245 H	195	95	22	300				1

VS 1500 H

GENERAL PURPOSE BOX

- Dimensions: H 330 x W 230 x D 100/120 mm



Code	No.	W	H	D	Icon 1	Icon 2
5797770	VS 1500 H				1500	

VS 1582

STORAGE TRAY



Code	No.	Description	H	W	D	W	H	D	Icon 1	Icon 2
5150000	VS 1582-1	Storage tray 50x320x150 mm	50	320	150	1016				1
5150190	VS 1582-2	Tray for drawings 150x320x50 mm	150	320	50	1270				1
5150270	VS 1582-3	Storage tray 100x320x90 mm	100	320	90	1118				1

H 6

HOLDER

- For double open ended spanner sets no. 6
- Suitable for perforated panels with square perforation 9 x 33 mm



E-PH 6



H 6-8 L



H 6-12 L



H 6-8 B



H 6-12 B

Code	No.	Description	W	H	D	W	H	D	Icon 1	Icon 2
5079110	H 6-8 B	Sheet metal holder, empty for 8 spanners no. 6	390	140	15	372				1
5079540	H 6-12 B	Sheet metal holder, empty for 12 spanners no. 6	600	170	15	655				1
5070080	H 6-8 L	Plastic holder, empty for 8 spanners no. 6	250	70	57	154				1
5070160	H 6-12 L	Plastic holder, empty for 12 spanners no. 6	325	100	57	270				1
5073930	E-PH 6-8 L	Plastic holder, empty for 8 spanners no. 6				18				1
5074070	E-PH 6-12 L	Plastic holder, empty for 12 spanners no. 6				38				1



1500 HS						
HOOK ASSORTMENT						
<ul style="list-style-type: none"> Suitable for perforated panels with square perforation 9 x 33 mm 						
Code	No.	Contents	Use			
5802870	1500 HS 1	4x 1500 H 0-50 18x 1500 H 1-50 1x H 6-8 B 1x VS 245 H	S 1005 A S 1151 M S 1151 A	1540	1	
5802950	1500 HS 2	23x 1500 H 1-50 6x 1500 H 2-13 2x VS 245 H	S 1002 M	1000	1	
5803090	1500 HS 3	7x 1500 H 0-50 24x 1500 H 1-50 2x 1500 H 2-13 2x 1500 H 3 1x VS 245 H	S 1004 M S 1005 A	1110	1	
5803170	1500 HS 4	4x 1500 H 0-50 17x 1500 H 1-50 6x 1500 H 3 1x VS 245 H	S 1006 M	870	1	
5803250	1500 HS 5	12x 1500 H 0-50 20x 1500 H 1-50 1x 1500 H 38 1x VS 245 H	S 1400 GM S 1400 GA S 1400 GZA	2334	1	
5803330	1500 HS 6	7x 1500 H 0-50 25x 1500 H 1-50 1x VS 245 H	S 1011 M	1386	1	
5803920	1500 HS 7	12x 1500 H 0-50 22x 1500 H 1-50 3x 1500 H 2-13 3x 1500 H 3 1x VS 245 H	S 1009 M	1260	1	
5805460	1500 HS 8	14x 1500 H 0-50 18x 1500 H 1-50 1x H 6-12 B	S 1007 M S 1008 M S 1013 M	1510	1	
5805540	1500 HS 9	4x 1500 H 0-50 16x 1500 H 1-50 1x H 6-8 B 1x VS 245 H		1524	1	
5805620	1500 HS 10	9x 1500 H 0-50 25x 1500 H 1-50 2x 1500 H 2-13 1x 1500 H 3 1x VS 245 H	S 1004 M	1648	1	
5799980	1500 HS 11	14x 1500 H 0-50 23x 1500 H 1-50 1x 1500 H 2-13 2x 1500 H 3 1x 1500 H 38 1x VS 245 H	S 1400 GM S 1400 GA S 1400 GZA	2680	1	
5805700	1500 HS 12	12x 1500 H 0-50 25x 1500 H 1-50 3x 1500 H 2-13 3x 1500 H 3 1x VS 245 H	S 1009 M	1846	1	
5805890	1500 HS 13	16x 1500 H 0-50 19x 1500 H 1-50 3x 1500 H 2-13 2x 1500 H 3 1x H 6-12 B 1x VS 245 H	S 1008 M	2234	1	
5802010	1500 HS 14	6x 1500 H 0-50 20x 1500 H 1-50 6x 1500 H 2-13 1x 1500 H 3 1x H 6-8 B 1x VS 245 H 1x VS 19 H	S 1151 M S 1151 A	2388	1	
5805970	1500 HS 15	25x 1500 H 1-50 9x 1500 H 2-13 1x 1500 H 3 2x VS 245 H 1x VS 19 H	S 1002 M	1570	1	
5806510	1500 HS 16	7x 1500 H 0-50 29x 1500 H 1-50 5x 1500 H 2-13 3x 1500 H 3 1x VS 245 H 1x VS 19 H	S 1004 M	2330	1	
5804060	1500 HS 17	15x 1500 H 0-50 32x 1500 H 1-50 4x 1500 H 2-13 2x 1500 H 3 1x 1500 H 27 1x 1500 H 38 2x VS 245 H 1x VS 19 H	S 1400 GM, S 1400 GA	3514	1	
5807160	1500 HS 18	12x 1500 H 0-50 32x 1500 H 1-50 4x 1500 H 2-13 4x 1500 H 3 1x VS 245 H 2x VS 19 H		3008	1	
5809370	1500 HS 19	4x 1500 H 0-50 28x 1500 H 1-50 3x 1500 H 2-13 7x 1500 H 3 2x VS 245 H 1x VS 19 H		2584	1	
5860050	1500 HS 20	7x 1500 H 0-50 47x 1500 H 1-50 2x 1500 H 3 1x VS 245 H	S 1011 M	1740	1	

Code	No.	Contents	Use			
5860130	1500 HS 21	15x 1500 H 0-50 35x 1500 H 1-50 5x 1500 H 2-13 2x 1500 H 3 1x H 6-12 B 1x VS 19 H		3134	1	
5860210	1500 HS 22	5x 1500 H 0-50 38x 1500 H 1-50 3x 1500 H 2-13 8x 1500 H 3 1x VS 245 H 2x VS 19 H	S 1006 M	3068	1	
5804220	1500 HS 23	17x 1500 H 0-50 43x 1500 H 1-50 12x 1500 H 2-13 10x 1500 H 3 1x 1500 H 27 1x 1500 H 38 2x VS 245 H 1x VS 19 H	S 1400 GZA	4958	1	
5860480	1500 HS 24	11x 1500 H 0-50 42x 1500 H 1-50 6x 1500 H 2-13 4x 1500 H 3 1x VS 245 H 2x VS 19 H	S 1009 M	3620	1	
5860560	1500 HS 25	20x 1500 H 0-50 42x 1500 H 1-50 5x 1500 H 2-13 3x 1500 H 3 1x H 6-12 B 2x VS 245 H 1x VS 19 H	S 1007 M S 1008 M S 1013 M	3170	1	
2008726	1500 HS 26	3x 1500 H 29-100 4x 1500 H 20-35 3x 1500 H 21-35 1x 1500 H 22-35 1x 1500 H 23-40		616	1	
2008734	1500 HS 27	2x 1500 H 2-10 1x 1500 H 2-13 2x 1500 H 20-75 2x 1500 H 21-35 1x 1500 H 21-50 2x 1500 H 22-55 1x 1500 H 24-6 5x 1500 H 29-50 1x 1500 H 34-14 1x 1500 H 37		1322	1	
2008742	1500 HS 28	4x 1500 H 20-35 2x 1500 H 20-75 2x 1500 H 20-135 6x 1500 H 21-35 2x 1500 H 22-35 1x 1500 H 23-40 1x 1500 H 24-6 3x 1500 H 29-50 3x 1500 H 29-100 2x 1500 H 31 1x 1500 H 34-14 1x 1500 H 37		1768	1	
5802440	1504 HG	13x 1500 H 0-50 13x 1500 H 1-50 1x H 6-12 B 2x VS 245 H	R 1504 LH BR 1504 0511 LH BR 1504 0511 S	1958	1	
5801550	1582 HG	10x 1500 H 1-50 5x 1500 H 2-13 5x 1500 H 3		654	1	

STAND ASHTRAY**1500 ST****STAND ASHTRAY**

- Sturdy design in powder-coated sheet steel
- Convenient apertures for larger litter on three sides
- Ashtray insert in sheet steel



Code	No.	L	W	H		
1531468	1500 ST	200	200	630	5.1	1



TOOL BOXES

- ✔ With riveted joints
- ✔ Compartments to be fully pulled out
- ✔ Great stability even if only one side is opened
- ✔ In GEDORIT blue
- ✔ Tools not supplied

1263

TOOL BOX 3 compartments

- ✔ With riveted joints
- ✔ Compartments to be fully pulled out
- ✔ Great stability even if only one side is opened
- ✔ GEDORIT blue powder-coated
- ✔ Dimensions: H 158 x W 420 x D 225 mm
- ✔ Particularly suitable for tool assortments S 1151 M and S 1151 A
- ✔ Delivery without tools

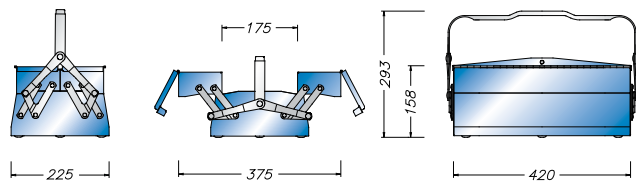
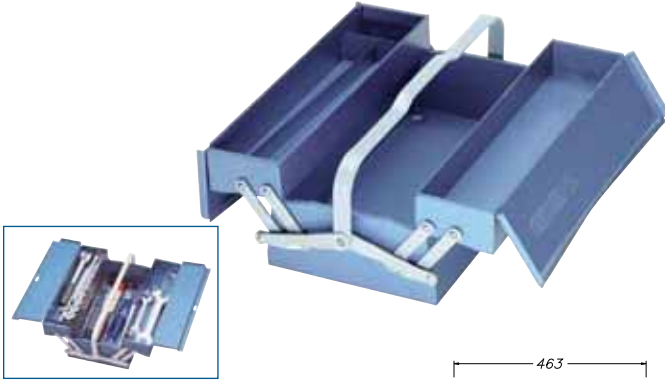

Code	No.	Compilation	H	W	D	Weight
6608250	1263 L	Tool box empty	158	420	225	4.0
6608330	1263-1151 M	Tool box 1263 L + assortment S 1151 M	158	420	225	15.8
6608410	1263-1151 A	Tool box 1263 L + assortment S 1151 A	158	420	225	15.8

1265

TOOL BOX 5 compartments

- ✔ With riveted joints
- ✔ Compartments to be fully pulled out
- ✔ Great stability even if only one side is opened
- ✔ GEDORIT blue powder-coated
- ✔ Dimensions: H 210 x W 420 x D 225 mm
- ✔ Particularly suitable for tool assortments S 1151 M and S 1151 A
- ✔ Delivery without tools

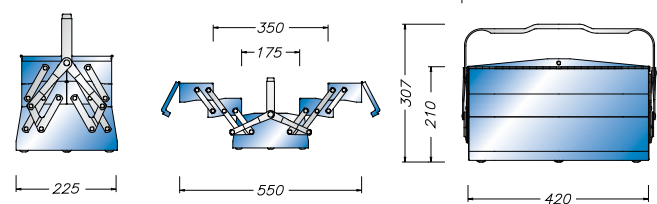
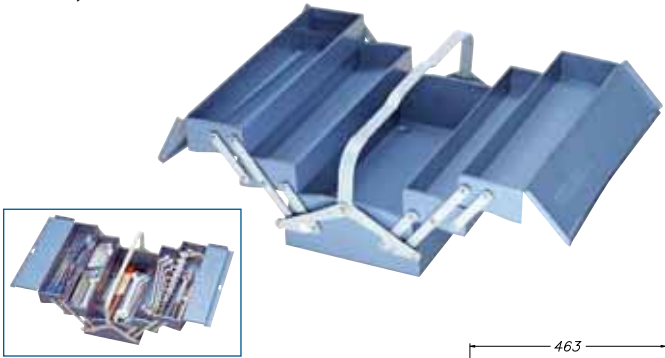

Code	No.	Compilation	H	W	D	Weight
6609060	1265 L	Tool box empty	210	420	225	5.2
6609140	1265-1151 M	Tool box 1265 L + assortment S 1151 M	210	420	225	17.3
6609220	1265-1151 A	Tool box 1265 L + assortment S 1151 A	210	420	225	17.3

1335

TOOL BOX 5 compartments, long pattern

- ✔ With riveted joints
- ✔ Compartments to be fully pulled out
- ✔ Great stability even if only one side is opened
- ✔ GEDORIT blue powder-coated
- ✔ Dimensions: H 210 x W 535 x D 225 mm
- ✔ Particularly suitable for tool assortments S 1151 M and S 1151 A
- ✔ Delivery without tools

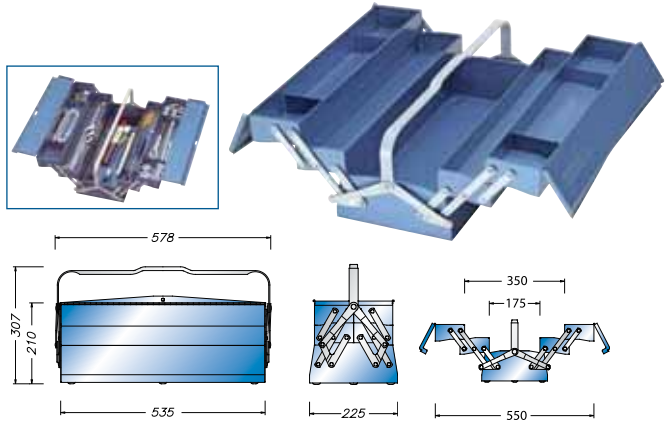

Code	No.	Compilation	H	W	D	Weight
6610580	1335 L	Tool box empty	210	535	225	6.3
6610660	1335-1151 M	Tool box 1335 L + assortment S 1151 M	210	535	225	18.5
6610740	1335-1151 A	Tool box 1335 L + assortment S 1151 A	210	535	225	18.5



Tool boxes

- ✔ Made of electrolytically zinc-plated sheet steel and therefore suitable for outdoors

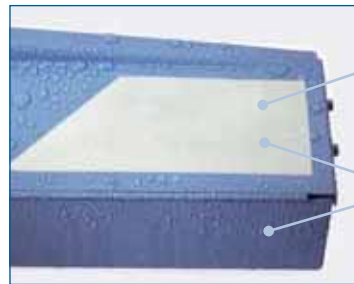

✔ As the zinc coating acts as a sacrificial anode, it protects should the other protective coating become damaged

✔ Optimum corrosion-proofing achieved with 2 protective coats, zinc and powder coating

Optional accessories



S 1151 M / S 1151 A



S 1151 M



S 1151 A

**68
77**

**TOOL CHESTS****1410 L****TOOL CHEST**

- With three large and three small drawers and carrying tray
- All drawers fully extendable on runners
- Made from sturdy sheet steel, fitted with central lock
- Particularly suitable for tool assortments S 1002 M and S 1005 A
- In GEDORIT blue, drawers GEDORIT silver
- Dimensions: H 364 x W 663 x D 308 mm
- Delivery without tools



Code	No.	H	W	D	
6614300	1410 L	364	663	308	28.0

1420 L**TOOL CHEST**

- With three large drawers and carrying tray
- All drawers fully extendable on runners
- Made from sturdy sheet steel, fitted with central lock
- Particularly suitable for tool assortments S 1002 M and S 1005 A
- In GEDORIT blue, drawers GEDORIT silver
- Dimensions: H 298 x W 610 x D 265 mm
- Delivery without tools



Code	No.	H	W	D	
6615700	1420 L	298	610	265	20.0

Optional accessories**S 1002 M****69****S 1005 A****77****TOOL BOXES****1072 ES****TOOL MODULE EMPTY**

- For tool modules 1500 ES
- May be individually equipped with two or three tool modules
- Foam rubber firmly glued to lid
- Suitable as spare part in tool chest 1433 L
- Sturdy sheet steel, in GEDORIT blue
- Dimensions: W 478 x D 313 x H 70 mm
- Delivery without tools



Code	No.	W	D	H	
6602990	1072 ES-1500 L	480	330	70	3.3

1370 Z**TOOL BOX**

- In special zinc-plated sheet steel for optimum protection against corrosion
- The manufacture using pressure-joint technology means great rigidity
- With removable small-parts compartment ES 1370 Z
- Fitted with carrying strap E-1370 in nylon fabric with shoulder protector
- Delivery without tools



Code	No.	H	W	D	
1497677	1370 Z	224	554	201.5	5.0
1497634	ES 1370 Z	69	179	167.0	0.6
5600300	E-1370				0.1

1072 K**TOOL BOX**

- Sturdy sheet steel, in GEDORIT blue
- With deep-drawn plastic insert with 19 compartments
- Fits into tool chest 1433 L
- Dimensions: W 480 x D 330 x H 70 mm
- (Ill. similar)



Code	No.	W	D	H	
1920049	1072 K-19	480	330	70	3.6

www.gedore.com



1440 Z

TOOL BOX JUMBO zinc-plated

- ✔ In special zinc-plated sheet steel for the heavy everyday-use
- ✔ Optimum corrosion protection, spray water protected
- ✔ Manufactured in pressure jointing technique, guarantees highest sturdiness
- ✔ Robust metal fittings and protected hinges
- ✔ Stopper to hold the lid open
- ✔ Wide carrying handles
- ✔ Max. loading 150 kg
- ✔ Lockable through padlock
- ✔ Lined interior
- ✔ Removable tray for small parts (ES 1440)
- ✔ Delivery without tools



Code	No.	H	W	D	WZ
6628280	1440 Z-70	320	698	387	17.0
6628360	1440 Z-83	340	841	427	21.0
6629170	1440 Z-91	440	918	537	30.0
6629250	1440 Z-100	320	998	387	22.0

1441 Z

TRANSPORT FRAME zinc-plated

- ✔ In special zinc-plated sheet steel
- ✔ Makes the tool boxes JUMBO 1440 / 1440 Z mobile
- ✔ With 4 castors, 2 of them with brake
- ✔ Delivery dismantled, for self-assembly



Code	No.	H	W	D	WZ
1497766	1441 Z-70	135	697	386	4.9
1497774	1441 Z-83	135	840	426	5.4
1497782	1441 Z-91	135	917	536	6.0
1497790	1441 Z-100	135	997	386	5.8

1440

TOOL BOX JUMBO

- ✔ Sheet steel construction with strong handles (apart from 1440-45, 1440-64)
- ✔ In GEDORIT blue, waterproof
- ✔ Strong joints, handles and stopper to hold the lid open
- ✔ Special lining, with document partition and removable tray for small parts ES 1440 (available separately)
- ✔ Please order separately transport frame 1441 Z
- ✔ Special finishes available on request
- ✔ 1440-45 without small parts tray
- ✔ Supported load 1440-70, -83, -91, -100 up to 400 kg without using the fold-down handles. When lifting, static supporting power of the fold-down handles max. 150 kg



Code	No.	H	W	D	WZ
6612440	1440-45	230	450	230	4.0
6611040	1440-64	230	640	230	7.0
6616510	1440-70	320	698	387	19.0
6616780	1440-83	340	841	427	23.0
6616860	1440-91	440	918	537	32.0
6616940	1440-100	320	998	387	25.0
6611120	ES 1440-64				1.0
6616000	ES 1440-70				1.8
6616190	ES 1440-83				2.1
6616270	ES 1440-91				2.4
6616350	ES 1440-100				2.0

Optional accessories

S 1004 M



63

S 1006 M



71



TOOL CASES / ROLLER TOOL CASES

1014 L - 1015 L

ROLLER TOOL CASE

- Optionable available in silver (no. 1014 L) or black (no. 1015 L)
- 4x telescopic grip extending max. length: 1 metre
- Widely spaced wheels and large ball-bearing-mounted smooth-running wheels ensure the case can be pushed or pulled without tipping
- Frame made from aluminium profiles, body from tough, impact-resistant ABS
- When open, the case lid hinges lock in place to prevent unintentional closing
- Document partition in the lid
- The case body can be individually compartmentalised with lengthwise and crosswise dividers
- Equipped with push-fit compartments and the GEDORE "Cliptool system", enabling individualised arrangement of the tool holders
- Lockable with two tilt cylinder locks
- Internal dimensions: 470 x 210 x 360 mm
- Carrying capacity: 40 kg
- Tools not supplied



Code	No.	Colour	W	D	H	Wheels
1946315	1014 L	silver	470	360	210	6.8
1946323	1015 L	black	470	360	210	6.8

1016 L - 1018 L

TOOL CASE

- Frame made from aluminium profiles, body from tough, impact-resistant ABS
- When open, the case lid hinges lock in place to prevent unintentional closing
- Document partition in the lid
- The case body can be individually compartmentalised with lengthwise and crosswise dividers
- Equipped with push-fit compartments and the GEDORE "Cliptool system", enabling individualised arrangement of the tool holders
- Lockable with two tilt cylinder locks
- Ground slides ensure tilt-secure standing, and also protect sensitive surfaces
- Internal dimensions No. 1016 L: 460 x 165 x 310 mm
- Internal dimensions No. 1018 L: 470 x 180 x 360 mm
- Carrying capacity: 30 kg
- Tools not supplied



Code	No.	W	D	H	Wheels
1946331	1016 L	460	310	165	4.7
1946358	1018 L	470	360	180	5.1



@WORK



484
-
487



Optional accessories



S 1150 M • S1151 M



65
68



S 1150 M



S 1151 M





TOOL ASSORTMENTS

SYSTEM-BASED ARRANGEMENT +

FOR THE ENTIRE FAMILY +



SERVICE / FEATURES

54 - 57

TOOL ASSORTMENTS



58 - 84

TOOL BOXES

60 - 61



TOOL PANELS

79 - 81



ES MODULES

85 - 89



CT MODULES

90 - 93

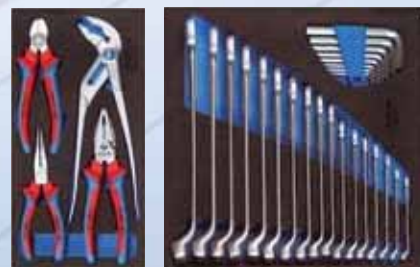

MODULE SYSTEM ++

With the user friendly tool modules from GEDORE · up from page 85





ES-TOOL MODULES

1/3 Modules





CT-TOOL MODULES

1/3 Modules



ES-TOOL MODULES

2/3 Modules

			
-------------------------------------------------------------------------------------	-------------------------------------------------------------------------------------	-------------------------------------------------------------------------------------	-------------------------------------------------------------------------------------

CT-TOOL MODULES

2/3 Modules

		
-------------------------------------------------------------------------------------	-------------------------------------------------------------------------------------	-------------------------------------------------------------------------------------

DIST. MODULES

Dist. modules



TOOL MODULES

- For keeping order in the GEDORE tool trolleys and mobile workbenches with variable divisions
- Dimensions:
 - 1/3 module = W 157.5 x D 310 mm
 - 2/3 module = W 315.0 x D 310 mm
- For models 1502, 1504, 2002, 2003, 2004, 2500 please order distance module 1500 ED-70 or 1500 ED-70 K additionally
- For model 1505 please order 1500 ED-70 or 1500 ED-70 K as well as 1500 ED-150 K additionally
- For model 2005 and 1504 XL please order 1500 ED-70 XL additionally



CT-INSERTS

- 2-colour plastic insert provides easy optical check of completeness
- Particularly suited for work in sensitive areas, in which it must be assured that no tools are left behind.
- Underlay blue, overlay black. A visible blue pocket indicates a missing tool
- Each tool is securely held in its own pocket, prevented from slipping and protected from damage
- Grip recesses facilitate removal of the tools
- Clearly visible tool contours simplify replacement into the correct pocket
- Resistant to oil and grease
- Easy to clean with water, soap and a nailbrush



ES-INSERTS

- From impact-resistant ABS
- Resistant to oil and acids
- Each tool is securely held in its own pocket, prevented from slipping and protected from damage
- Grip recesses facilitate removal of the tools



POSSIBLE COMBINATIONS OF THE MODULES TOOL TROLLEY AND WORKBENCH MODELS

1578, 1580, 1585, 2000, 2525, 2535, 3010 as well as the small drawers of 2500

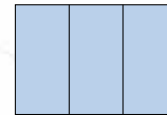

3x 1/3 modules

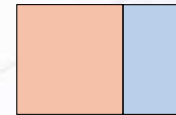

1x 2/3 modules and 1x 1/3 module

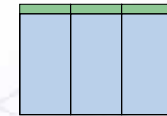

3x 1/3 modules
3x distance module 1500 ED-30

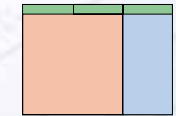

1x 2/3 modules and 1x 1/3 module
3x distance module 1500 ED-30

2003, 2004, 1502, 1504 as well as the big drawer of 2500

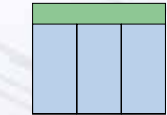

3x 1/3 modules
1x distance module 1500 ED-70 or 1500 ED-70 K

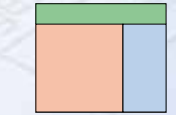

1x 2/3 and 1x 1/3 modules
1x distance module 1500 ED-70 or 1500 ED-70 K

2005, 1504 XL

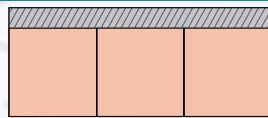

XL drawer 3x 2/3 modules
2x distance modules 1500 ED-70

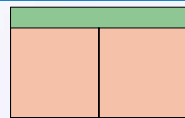

2x 2/3 modules
1x distance module 1500 ED-70 XL

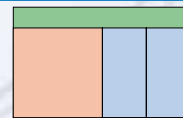

1x 2/3 and 2x 1/3 modules
1x distance module 1500 ED-70 XL

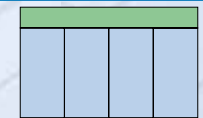

4x 1/3 modules
1x distance module 1500 ED-70 XL

B 1500, 1505

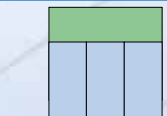

3x 1/3 modules
1x distance module 1500 ED-150 K



1x 2/3 and 1x 1/3 modules
1x distance module 1500 ED-150 K

2545, 2550, B 1510, B 1511

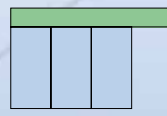

3x 1/3 modules
1x distance module 1500 ED-85

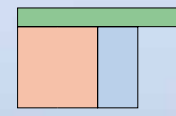

1x 2/3 and 1x 1/3 modules
1x distance module 1500 ED-85

*When ordering model 2003, 2004, 1502 or 1504 2 pieces of 1500 ED-70 K are supplied f.o.c.

MATCHING YOUR CHOSEN TOOLKIT TO THE RIGHT... ... TOOL TROLLEY, WORKBENCH OR CUPBOARD



The table allows you to make the right choice of safe and secure storage for any particular tool set.

The range of hooks (1500 HS) recommended for fitting in the panels with square holes can also be found in the relevant column.

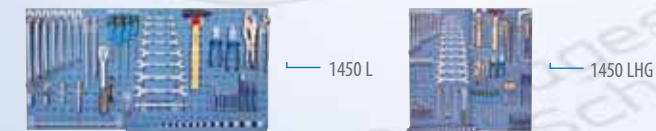
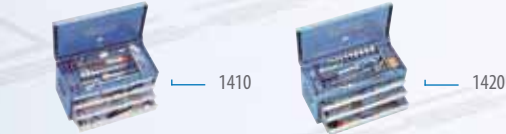



TOOL ASSORTMENTS

501 M

BASIC TOOL SET 29 pieces

- ✔ In practical black leather case with zip fastener
- ✔ Packed with a basic assortment of tools for emergencies
- ✔ Dimensions: W 300 x D 260 x H 45 mm
- ✔ Tools in metric sizes



Code	No.	Contents	
6511090	501 M	29 tools in metric sizes	2.5

Contents	
	7 10 11 12 13 17 19
	142 10 TL
	625 M

Contents	
	647
	4629
	8210 -160 JC

Contents	
	600 H -200
	2150 4 5,5 6,5
	2160 PH 1 2
	2170 3
	E-501 ST

1000

TOOL CASE TOURING 47 pieces

- ✔ The perfect assortment for most problems
- ✔ A carefully developed assortment of tools specified as the most useful
- ✔ Packed in a handy plastic case
- ✔ The reliable companion in a car, boat or small aircraft
- ✔ Useful in the home - where good tools are always needed
- ✔ All 47 pieces are well laid out and securely fastened
- ✔ With the TOURING 1000 repairs and maintenance become easy
- ✔ The case is made from impact-resistant blown polypropylene, resistant to oil and acid and extremes of weather, with foam insert
- ✔ Secure fastenings - tested to 30000 movements
- ✔ Secure locking with two stage mechanism
- ✔ Folding carrying handle, large and strong
- ✔ GEDORE vanadium tools, chrome-plated
- ✔ No. 1000 = set with case
- ✔ No. S 1000 = set without case



Code	No.	Contents	
6600780	1000	47 tools in case	7.0
6600190	S 1000	47 tools without case	5.3

1000

S 1000

Contents	
	7 6 7 8 10 11 12 13 14 15 17 19
	19 10 11 12 13 14 15 17 19 22
	1990 -5-10
	1987
	1995
	1993 U -10T

Contents	
	42 2 (5/64AF) 2,5 3 4 5 6 8 10
	2150 4 5,5 6,5
	2160 PH 1 2
	2170 3
	4610
	4615 3
	4522

Contents	
	50 MH
	145 10 C
	8210 -180 JC
	8316 -160 JC
	600 H -300
	E-1000 P



1050 M

TOOL ASSORTMENT AUTODOCTOR 29 pieces

- Breakdown assortment for cars
- In practical artificial leather wallet
- Set in metric sizes
- No. 1050 M = set in wallet
- No. S 1050 M = set without wallet



1050 M

Code	No.	Contents	
6604770	1050 M	29 tools in wallet	3.2
6604850	S 1050 M	29 tools without wallet	2.6

Contents
7 8 10 12 13 14 17 19
49 D 49 R
145 10 C
625 M
4611

Contents
4522
8250 -180 JC
600 H -300
2150 4 5,5 6,5
2160 PH 2



S 1050 M

1090

TOOL CASE ELECTRICIAN 90 pieces

- The perfect tool set for the electrician or property manager
- A thoughtful assortment for the work to be done
- Packed in a strong plastic case with aluminium frame
- Three steel hinges, screwed handle, fitted with built in locks
- May be used wherever the right tools have to be always at hand
- GEDORE vanadium tools, chrome-plated
- Dimensions: W 460 x D 380 x H 200 mm
- No. 1090 = set with case
- No. S 1090 = set without case
- No. WK 1090 L = case empty



1090



1090



1090



1090

Code	No.	Contents	
6601590	1090	90 tools in case	13.2
6601400	S 1090	90 tools without case	8.3
5600060	WK 1090 L	Case empty	4.2

Contents
401
401 A [10x]
6 14x17 18x19 21x23 22x24
8 4 4,5 5,5 6 7 8 9 10 11 12 13
20 4 4,5 5,5 6 7 8 9 10 11 13
2087
2095
2098
2090 -4
2093 U -3
42 2 (5/64AF) 2,5 3 4 5 6 7 8 10
60 CP 10
156 S

Contents
2153 5,5
2161 PH 1
2160 PZ 1 2
VDE 2160 PH 1 2
VDE 2170 3,5 4 5,5 6,5
4615 3,5
173 5,5 8
174 1
745
4522
4534 -3
145 10 JC
8096 -140

Contents
VDE 8098 -160
VDE 8120 -160
VDE 8250 -180
VDE 8132 AB -160
VDE 8316 -200
95 -175
99 10-2 10-4
101
112 A -250
112 S
600 H -300
72 H -100
E-1090 LK LZ LF LS



TOOL BOXES



- ✔ With riveted joints
- ✔ Compartments to be fully pulled out
- ✔ Great stability even if only one side is opened
- ✔ In GEDORIT blue
- ✔ Tools not supplied

- ✔ Made of electrolytically zinc-plated sheet steel and therefore suitable for outdoors

- ✔ Optimum corrosion-proofing achieved with 2 protective coats, zinc and powder coating

- ✔ As the zinc coating acts as a sacrificial anode, it protects should the other protective coating become damaged

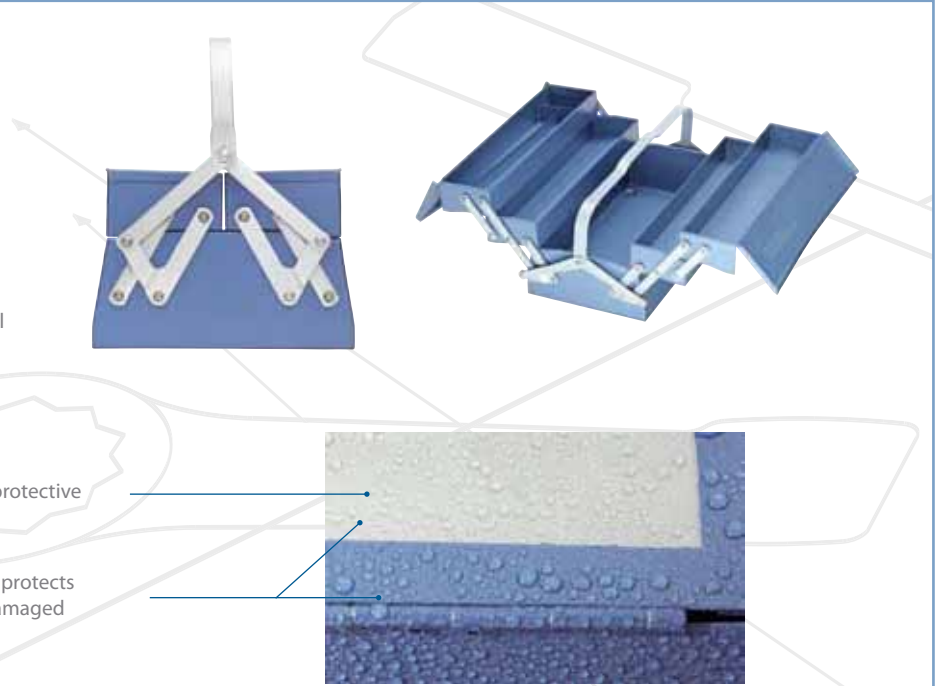

1263

TOOL BOX 3 compartments

- ✔ With riveted joints
- ✔ Compartments to be fully pulled out
- ✔ Great stability even if only one side is opened
- ✔ GEDORIT blue powder-coated
- ✔ Dimensions: H 158 x W 420 x D 225 mm
- ✔ Particularly suitable for tool assortments S 1151 M and S 1151 A
- ✔ Delivery without tools

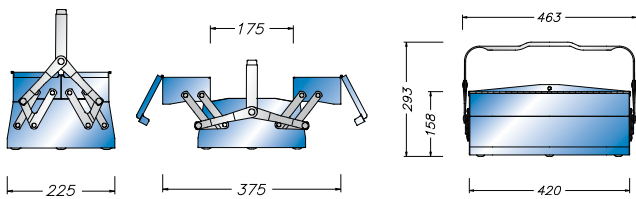
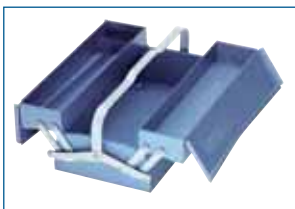

Code	No.	Compilation	H	W	D	Weight
6608250	1263 L	Tool box empty	158	420	225	4.0
6608330	1263-1151 M	Tool box 1263 L + assortment S 1151 M	158	420	225	15.8
6608410	1263-1151 A	Tool box 1263 L + assortment S 1151 A	158	420	225	15.8

1265

TOOL BOX 5 compartments

- ✔ With riveted joints
- ✔ Compartments to be fully pulled out
- ✔ Great stability even if only one side is opened
- ✔ GEDORIT blue powder-coated
- ✔ Dimensions: H 210 x W 420 x D 225 mm
- ✔ Particularly suitable for tool assortments S 1151 M and S 1151 A
- ✔ Delivery without tools

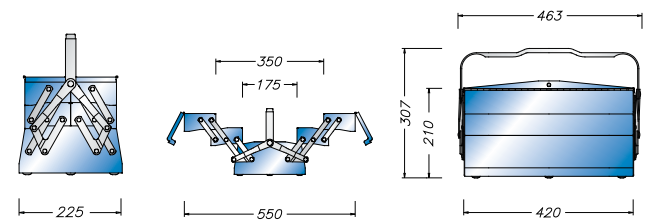
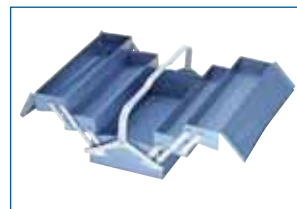

Code	No.	Compilation	H	W	D	Weight
6609060	1265 L	Tool box empty	210	420	225	5.2
6609140	1265-1151 M	Tool box 1265 L + assortment S 1151 M	210	420	225	17.3
6609220	1265-1151 A	Tool box 1265 L + assortment S 1151 A	210	420	225	17.3



1335

TOOL BOX 5 compartments, long pattern

- With riveted joints
- Compartments to be fully pulled out
- Great stability even if only one side is opened
- GEDORIT blue powder-coated
- Dimensions: H 210 x W 535 x D 225 mm
- Particularly suitable for tool assortments S 1151 M and S 1151 A
- Delivery without tools

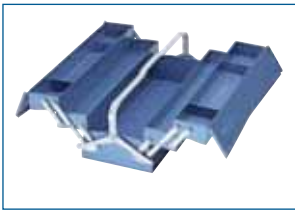
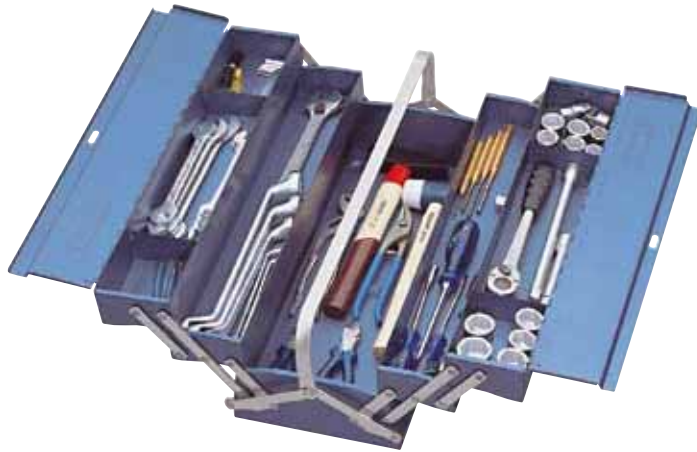

Code	No.	Compilation	H	W	D	
6610580	1335 L	Tool box empty	210	535	225	6.3
6610660	1335-1151 M	Tool box 1335 L + assortment S 1151 M	210	535	225	18.5
6610740	1335-1151 A	Tool box 1335 L + assortment S 1151 A	210	535	225	18.5

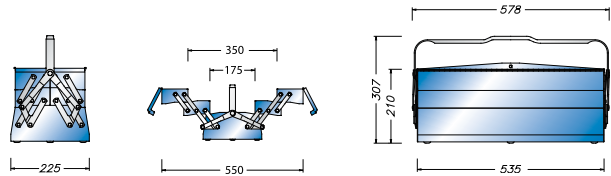

1091

ELECTRICIANS TOOL CASE 18 pieces

- Robust tool case with 18-piece basic assortment. Particularly suitable for beginners in electronic professions
- From eco-friendly tanned cowhide
- Carefully processed with strong industrial seams
- Base insert from zinc-plated sheet steel
- Edges reinforced with aluminium angle brackets, metal parts durable riveted
- With feet to protect sensitive surfaces
- Front part can be lowered for quick access to the tools, with two key locks to prevent inadvertent opening
- Removable carrying strap with shoulder protector and sturdy carrying handle
- Anti-theft protection due to two lockable notches, delivery includes two keys
- Document partition
- Interior measurements 430 x 200 x 290 mm
- No. 1091 = set with case
- No. WK 1091 L = case empty



Code	No.	Contents	
1953710	1091	18 tools in case	6.0
1953729	WK 1091 L	Case empty	4.2

Contents	
VDE 2133 7 8 10	
VDE 2160 PH 1 2 3	
VDE 2170 3 4 5,5	
4528	
4533 -2	

Contents	
V 4614 PLUS	
4629	
8097	

Contents	
VDE 8132 -160 H	
VDE 8250 -180 H	
VDE 8316 -180 H	
E-1091 ST	



1092

SOLAR INSTALLATION KIT 25 pieces

- ✔ Robust tool case with 25-piece GEDORE tool assortment
- ✔ Developed from everyday workshop routine
- ✔ Especially suitable for the rooftop installation of solar panels
- ✔ Case from eco-friendly tanned cowhide
- ✔ Carefully processed with strong industrial seams
- ✔ Base insert from zinc-plated sheet steel
- ✔ Edges reinforced with aluminium angle brackets, metal parts durable riveted
- ✔ Front part with two key locks to prevent inadvertent opening
- ✔ Removable carrying strap with shoulder protector and sturdy carrying handle
- ✔ Anti-theft protection due to two lockable notches, delivery includes two keys
- ✔ Interior measurements 430 x 200 x 290 mm



Code	No.	Contents	Weight
1988441	1092	25 tools in metric sizes	7.6
1953729	WK 1091 L	Case empty	4.2

Contents
7 R 8 10 13 17 19
60 CP 10
145 10 JC [2x]
2160 PH 0 1 2
DT 42 6
404

Contents
8722 2-8
4533 -2
688 TX T25 T30 T40
676
699

Contents
600 H -300
218010
8314 -140 JC
4528
8097

S 1093

TOOL ASSORTMENT 26 pieces

- ✔ Particularly suited as the initial outfit for electrical specialists
- ✔ The GEDORE tool case or tool trolley are suited for mobile assignments



Code	No.	Contents	Weight
2319942	S 1093	26 Tools	

Contents
142 10 C
VDE 8250 -180 H
VDE 8132 -160 H
VDE 8314 -160 H
VDE 2170 4 5,5 6,5 8

Contents
VDE 2160 PZ 1 2
V 4614 PLUS
42 2 (5/64AF) 2,5 3 4 5 6 8 10
4533 -2
4528
8097

Contents
600 H -500
112 A -250
110 HS -318
0175 -06



S 1004 M

MECHANIC'S TOOL ASSORTMENT 80 pieces

- Particularly suitable for the rear panel R 1504
- Recommended hook assortments 1500 HS 3 (36 pcs) or 1500 HS 16 (46 pcs)
- Tools in metric sizes

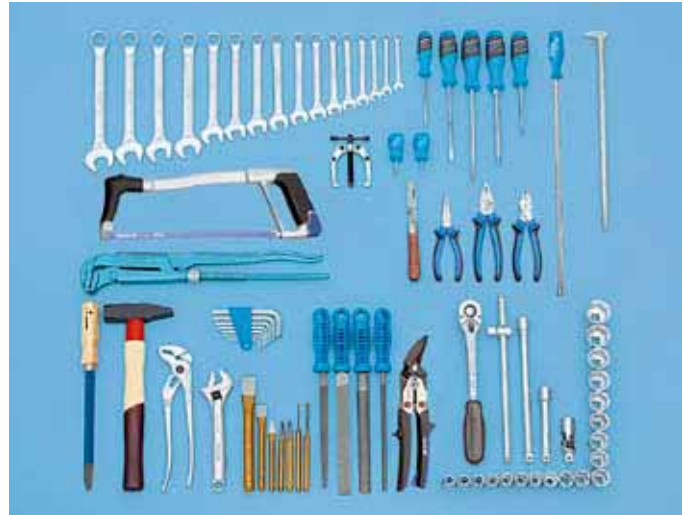

Code	No.	Contents	
6600000	S 1004 M	80 tools in metric sizes	14.1

	Contents
	7 8 9 10 11 12 13 14 15 16 17 18 19 21 22 23 24
	19 10 11 12 13 14 15 16 17 18 19 21 22 23 24 26 27 28 30 32
	1987
	1995
	1990 -5 -10
	1993 U -10 T
	42 2 (5/64AF) 2,5 3 4 5 6 8 10
	60 CP 8
	143 10 C
	175 1.1/2
	139 -400
	100 -10

	Contents
	99 10-3
	97 -150 -200
	98 -125
	119 -3 -5
	403
	640 -1800
	132 -150
	4522
	8250 -180 JC
	8132 -160 JC
	8316 -160 JC

	Contents
	424026
	600 H -500
	8701 2-8
	8719 2-8
	8722 2-8
	8725 2-8
	2150 4 6,5 8
	2153 5,5
	2160 PH 2 3
	2161 PH 2
	1.12 /01



2004

20











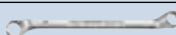
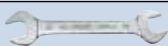



S 1400 GM









UNIVERSAL TOOL ASSORTMENT 100 pieces



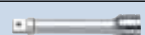

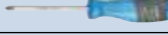



- ✔ Tools in metric sizes
- ✔ Supplied in tool modules 1500 ES, suitable to fit in 5 drawers of the GEDORE tool trolleys and workbenches
- ✔ Recommended hook assortments 1500 HS 5 (34 pcs), 1500 HS 11 (42 pcs) or 1500 HS 17 (59 pcs)



Code	No.	Contents	
6612790	S 1400 GM	100 tools in metric sizes	17.7

Contents	
	42 1,3 1,5 2 (5/64AF) 2,5 3 4 5 6 8 10
	2 6x7 8x9 10x11 12x13 14x15 16x17 18x19 20x22
	6 6x7 8x9 10x11 12x13 14x15 16x17 18x19 20x22 21x23 24x27
	19 10 11 12 13 14 15 16 17 18 19 21 22 23 24 26 27 28 30 32
	IN 19 6 7 8 9 10 12 14
	142 10 JC
	8132 -160 JC
	8250 -180 JC
	8316 -160 JC
	97 -250
	98 -125
	99 12-5
	100 -12
	119 -1,5 -3 -4
	600 H -300
	600 E -500
	225 E -40

Contents	
	1993 U -10 T
	1987
	1995
	1990 -5 -10
	2133 5,5 6 7 8 9 10
	2150 4,5 5 6,5 8
	2160 PH 1 2
	60 CP 8
	137 10
	406

Contents	
	403
	8701 2-6
	8719 2-6
	8722 2-6
	8728
	132 -150
	424026
	1500 E-N L [3x]





S 1400 ZM

SUPPLEMENTARY TOOL ASSORTMENT FOR S 1400 GM 34 pieces
 ▽ Tools in metric sizes



Code	No.	Contents	
6612950	S 1400 ZM	34 tools in metric sizes	11.3

Contents	
	1990 -2.1/2 -3
	INX 19 L 6-100 8-100 10-100 12-100
	2153 6,5
	2161 PH 2
	27 24x27 30x32
	27 D
	28 PU CS
	36 1-140
	38 20 [2x]

Contents	
	50
	54
	125 1
	128 2-225
	135 13

Contents	
	299
	625 M
	640 -1800
	702 13 M
	4610
	8729 [2x]

S 1150 M

UNIVERSAL TOOL ASSORTMENT 41 pieces
 ▽ For car repairs, household repairs and for the professional
 ▽ Tools in metric sizes



Code	No.	Contents	
6606980	S 1150 M	41 tools in metric sizes	4.8

Contents	
	1 B 8 10 11 13 14 15 17 19 22
	30 6 7 8 9 10 11 12 13 14 15 17 19 22
	3090 -3 -5 -10
	3095
	3093 GU -3

Contents	
	42 3 4 5 6 8 10
	52
	145 10 C
	2150 5,5 8

Contents	
	2160 PH 2
	8250 -180 JC
	97 -125
	600 H -300









S 1025

SANITARY TOOL ASSORTMENT STARTER 49 pieces

- ✔ User-friendly set for future plant mechanics in sanitary, heating and air condition technology
- ✔ Suitable for mobile applications in GEDORE toolboxes, tool chests or tool cases



Code	No.	Contents
2319896	S 1025	49 tools

Contents	
	231000
	225010
	232001
	100 1.1/2
	914424
	316000
	317000
	379100
	320000

Contents	
	329000
	406
	4522
	600 H -500
	4533 -2
	2150 4 5,5
	2160 PH 1 PH 2
	4615 3
	7 R 10 13 17 19 24
	920 11

Contents	
	680 4 6,5
	685 3 4 5 6
	685 X 5 6 8
	690 1 2
	690 PZD 1 2 3
	687 TX T8 T9 T10 T15 T20 T25 T27 T30 T40
	620

i 2333



531







S 1024

SANITARY TOOL ASSORTMENT PROFI 63 pieces

- ✔ User-friendly set for plant mechanics in sanitary, heating and air condition technology
- ✔ Suitable for mobile applications in GEDORE toolboxes, tool chests or tool cases



Code	No.	Contents	
2319888	S 1024	63 tools	

Contents
7 R 10 11 12 13 14 15 16 17 18 19 22 24
220020
231000
225011
226842
245010
100 1" 1.1/2"
914424
8314-160 JC
8133-180 JC
112-2510

Contents
110 HS -256
4533 -2
316000
316 501 502 503
317000
380 100 200
378500
4615 3
2150 4 5,5 8
2160 PH 1 PH 2
42 1,3 1,5 2 (S/64AF) 2,5 3 4 5 6 8 10
1994
403
4522

Contents
646
600 H -500
620 H -1250
424026
312000
314000
320000
329000
232001
232500
3810 30
1990 -5

920

487

923

487

218

527

S 1151 M

TOOL ASSORTMENT 68 pieces

- For workshops and service stations
- Recommended hook assortments 1500 HS 1 (24 pcs) or 1500 HS 14 (36 pcs)
- Tools in metric sizes



Code	No.	Contents	
6607010	S 1151 M	68 tools in metric sizes	9,6

Contents
2 8x9 10x11 12x13 14x15 16x17 18x19 20x22
6 6x7 8x9 10x11 12x13 14x15 16x17 18x19 20x22
19 10 11 12 13 14 15 17 19 22 24 27 30 32
1990 -3 -5 -10
1987
1995
1993 U -10 T
38 16 [2x]
42 2,5 3 4 5 6 8

Contents
2150 4 6,5 8
2160 PH 2
50
137 10
145 10 C
299
100 -12
99 10-4

Contents
97 -150
625 M
4611
8250 -180 JC
8316 -160 JC
600 H -500





S 1002 M

TOOL ASSORTMENT FOR TRACTORS 79 pieces

- For German tractors and other agricultural machines, especially "International Harvester"
- Recommended hook assortments 1500 HS 2 (31 pcs) or 1500 HS 15 (38 pcs)
- Tools in metric sizes



Code	No.	Contents	
6600270	S 1002 M	79 tools in metric sizes	16.1

	Contents
	1 B 6 7 8 9 10 11 12 13 14 15 16 17 18 19 20 22 23 24 27 28 30 32
	19 10 11 12 13 14 15 16 17 18 19 22 24 27 30 32
	IS 19 12x2
	1990 -5 -10
	1987
	1995
	1993 U -10 T
	38 20 [2x]
	42 3 4 5 6 8 10 12 14
	137 10
	145 10 C

	Contents
	147 5,5 7 9 12
	162 2
	100 -10
	99 12-5 12-6 12-8
	97 -150
	98 -125
	119 -3 -4 -5
	403
	132 -200

	Contents
	702 20 M
	4610
	8010 A 2
	8010 J 2
	8250 -180 JC
	8316 -160 JC
	600 H -500 -1000



923 **487**

1335 **48**

S 1016











BASIC TOOL ASSORTMENT IN TOOL CASE 90 pieces

- ✔ Ideal for mobile applications by fitters and service personnel
- ✔ Case, frame made from aluminium profiles, body from tough, impact-resistant ABS
- ✔ Lockable with two tilt cylinder locks
- ✔ Load capacity: 30 kg



Code	No.	Contents	4.7
2330792	1016	90 tools in case	
2319918	S 1016	90 tools	
1946331	1016 L	Case empty	4.7

Contents	
	7 8 9 10 11 12 13 14 15 17 19 22
	1993 U -10 T
	19 10 11 12 13 14 16 17 18 19 21 22 24
	1990 -5 -10
	1987
	D 20 4 5 6 7 8 9 10 11 12 13
	680 4 5,5 6,5
	685 3 4 5 6
	685 X 5 6 8
	687 TX T10 T15 T20 T25 T27 T30 T40
	690 1 2

Contents	
	690 PZD 1 2 3
	620
	676
	699
	2090 -4
	2093 U -20
	2150 4 5,5 6,5 8
	2160 PH 1 2
	42 2 (5/64AF) 2,5 3 4 5 6 8 10
	97 -125 -150
	98 -125

Contents	
	99 12-3
	100 -10
	119 -4
	8316 -180 JC
	8132 -160 JC
	142 10 TL
	600 H -500
	406
	4534 -5



1504



34





S 1006 M

TOOL ASSORTMENT FOR TRUCKS 115 pieces

- For service and repairs
- Recommended hook assortments 1500 HS 4 (28 pcs) or 1500 HS 22 (57 pcs)
- Tools in metric sizes



Code	No.	Contents	
6600940	S 1006 M	115 tools in metric sizes	33.3

Contents
1 B 8 9 10 11 12 13 14 15 16 17 18 19 21 22 23 24 26 27 29 30 32
19 10 11 12 13 14 15 16 17 18 19 21 22 23 24 26 27 28 30 32
IN 19 5 6 7 8 9 10 12 14 17
1990 -5 -10
1985
1987
1995
1993 U -10 T
32 19 22 24 27 29 30 32 36 38
3290 -8 -16
3287
3295
3293 U -3

Contents
60 CP 12
135 19
137 10
146 10 CP
100 2
147 7 9 10
2160 PH 1 2 3 4
100 -10
97 -200
119 -4 -5 -6
96 -200
407
407 A [12x]
644
132 -250

Contents
702 20 M
4534 -3
4610
8000 A 2 A 21
8000 J 2 J 21
8316 -160 JC
248 ST -50
225 E -32
600 H -100 -1500
8701 2-10



S 1023 M



















TOOL ASSORTMENT FOR MECHATRONICS 118 pieces















- ✔ Practical entry-level toolset
- ✔ The range includes mechanical and electrical engineering tools



Code	No.	Contents	
1999060	S 1023 M	118 tools in metric sizes	13.0

	Contents
	1 B 6 7 8 9 10 11 12 13 14 15 16 17 18 19 20 21 22
	D 20 4 5 6 7 8 9 10 11 12 13
	680 4 5,5 6,5
	685 3 4 5 6
	685 X 5 6 8
	687 TX T10 T15 T20 T25 T27 T30 T40
	690 1 2
	690 PZD 1 2 3
	620
	676
	699
	2090 -4
	2093 U -20
	1993 U -10 T

	Contents
	19 8 9 10 11 12 13 14 15 16 17 19 22 24 27 30 32
	1987
	1990 -5 -10
	1995
	VDE 8132 -200 H
	VDE 8250 -180 H
	VDE 8314 -160 H
	VDE 2170 4 5,5
	VDE 2160 PH 1 2
	V 4614 PLUS
	4615 3
	171 IS 1,2 1,5 2
	165 PH 00 0
	8305 -2
	8306 -5
	42 1,3 1,5 2 (5/64AF) 2,5 3 4 5 6 8 10
	97 -150
	100 -10

	Contents
	119 -3 -5
	600 H -500
	248 ST -30
	8701 2-8
	8719 2-8
	8722 2-8
	403
	4528
	710
	745
	4534 -3
	298 -04
	8354 -1
	8139 -220 TL



**S 1008 M****MECHANIC'S TOOL ASSORTMENT 138 pieces**

- ▶ A useful selection of tools for many jobs
- ▶ Recommended hook assortments 1500 HS 8 (33 pcs), 1500 HS 13 (42 pcs) or 1500 HS 25 (74 pcs)
- ▶ Tools in metric sizes



Code	No.	Contents	
6603610	S 1008 M	138 tools in metric sizes	23.5

	Contents
	2 6x7 8x9 10x11 12x13 14x15 16x17 18x19 20x22 21x23 24x27 25x28 30x32
	6 6x7 8x9 10x11 12x13 14x15 16x17 18x19 20x22 21x23 24x27 25x28 30x32
	19 8 10 11 12 13 14 15 16 17 18 19 21 22 23 24 26 27 28 30 32
	1987
	1995
	1990 -5 -10
	1993 U -10T
	20 4 4,5 5 5,5 6 7 8 9 10 11 13
	2090 -4
	2087
	2095
	2098
	2093 U -3
	42 2 (5/64AF) 2,5 3 4 5 6 8 10
	60 CP 8
	298 -04

	Contents
	137 10
	140
	143 10 C
	144 7 C
	156 5
	175 1.1/2
	139 -400
	100 -10
	99 10-3 12-5
	97 -125 -150 -200
	98 -125
	119 -3 -5
	407
	640 -1800
	132 -200
	710
	745
	4522
	4534 -3
	8000 A 2

	Contents
	8000 J 2
	8250 -180 JC
	8132 -160 JC
	8316 -160 JC
	8367 -160 JC
	8551 1 2 3 4 5 6 7 8
	600 H -500
	248 ST -40
	8701 2-8
	8719 2-8
	8722 2-8
	424026
	8728
	2150 3 4 5,5
	2153 6,5
	2154 6,5 8 10
	2160 PZ 1 2
	2160 PH 1 2 3
	2161 PH 1 2















S 1019



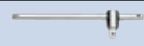

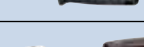

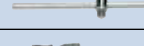
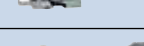





TOOL ASSORTMENT KFZ 157 pieces





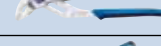







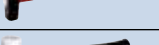
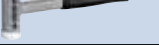

- ✔ Ideal for maintenance and service work on cars
- ✔ Suitable for cars of all brands with metric and TORX® screws
- ✔ For tool trolleys and work benches with min. 5 drawers



Code	No.	Contents
2319926	S 1019	157 tools

Contents
 6 6x7 8x9 10x11 12x13 14x15 16x17 18x19 20x22 21x23 24x27
 7 R 8 10 12 13 14 15 16 17 18 19
 400 8x10 10x11 12x14 17x19 13x15
 20 4 5 5,5 6 7 8 9 10 11 12 13 14
 IN 20 3 4 5 6 8
 TX 20 E4 E5 E6 E7 E8 E10
 ITX 20 T8 T9 T10 T15 T20 T25 T27 T30 T40
 2087
 2090 -4
 2095
 2098
 2093 U -10
 1993 U -20
 1987
 1995
 1990 -5 -10
 19 10 11 12 13 14 15 16 17 18 19 21 22 23 24 26 27 28 30 32

Contents
 IS 19 10x1,6 12x2
 IKS 19 2 3 4
 INX 19 8 10
 IN 19 5 6 7 8 9 10 12 14 17
 IN 19 L 5-90 6-90 8-90 10-140 12-140 14-140
 ITX 19 T20 T25 T27 T30 T40 T45 T50 T55 T60
 ITX 19 L T20-100 T25-100 T27-100 T30-100 T40-100 T45-100 T50-100 T55-100 T60-100
 708
 142 10 JC
 8132 -160 JC
 8250 -180 JC
 8316 -160 JC
 8000 A 1 2 21

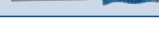
Contents
 8000 J 1 2 21
 2150 4 5,5 6,5 8
 2160 PH 1 2
 119 -3 -4 -5 -6 -7 -8
 600 H -500
 248 ST -40
 38 20
 643
 702 20 M
 4550 -20
 133 D -150
 132 -150
 8701 2-8
 8719 2-8
 8722 2-8
 8725 2-8
 8726



28 CU





573



S 1022

TOOL ASSORTMENT NFZ 158 pieces

- Ideal for maintenance and service work on industrial vehicles of all brands with metric and TORX® screws
- Suitable for 3000 TANTO tool trolleys and tool trolleys with min. 5 drawers

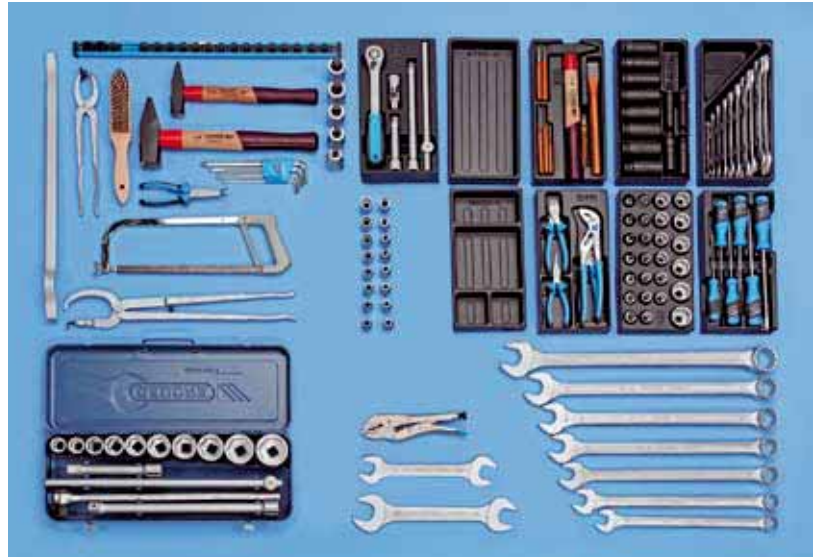

Code	No.	Contents	
2319934	S 1022	158 tools	

Contents
1993 U -20
1987
1995
1990 -5 -10
19 10 11 12 13 14 15 16 17 18 19 21 22 23 24 26 27 28 30 32
IN 19 6 7 8 9 10 12 14
K 19 L 10 13 14 16 17 18 19 21 22 23 24 27
2150 4 5,5 6,5 8
2160 PH 1 2
42 KEL 2 2,5 3 4 5 6 8 10
142 10 JC
8132 -160 JC

Contents
8250 -180 JC
8316 -160 JC
6 6x7 8x9 10x11 12x13 14x15 16x17 18x19 20x22 21x23 24x27 30x32 36x41
7 XL 24 27 30 32 34 36 41
97 -250
98 -125
99 12-5
100 -12
119 -1,5 -3 -4
600 H -300
137 10
TX 19 E10 E11 E12 E14 E16 E18 E20 E24
ITX 19 T20 T25 T27 T30 T40 T45 T50 T55
SL 1916

Contents
3293 U -2
32 22 24 27 30 32 36 38 41 46 50
3287
3290 -8 -16
ITX 32 T60 T70 T80 T90 T100
403
39
8138 -200 JC
135 13 20
646
600 H -500 -1500
1500 ED-30 [12x]
1500 E-N L [2x]
1500 E-S L

3000

23

1504 XL

33







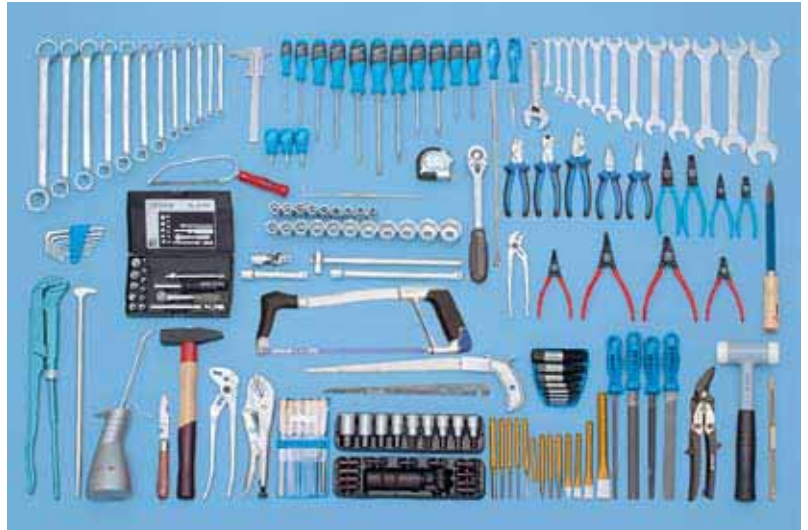





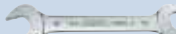





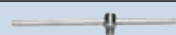























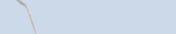

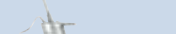











S 1007 M











MECHANIC'S TOOL ASSORTMENT 175 pieces

- ✔ A complete tool assortment for the professional
- ✔ Recommended hook assortments 1500 HS 8 (33 pcs) or 1500 HS 25 (74 pcs)
- ✔ Tools in metric sizes



Code	No.	Contents	kg
6601080	S 1007 M	175 tools in metric sizes	27.7

Contents	Contents
 2 6x7 8x9 10x11 12x13 14x15 16x17 18x19 20x22 21x23 24x27 25x28 30x32	 143 10 C
 6 6x7 8x9 10x11 12x13 14x15 16x17 18x19 20x22 21x23 24x27 25x28 30x32	 144 7 C
 19 8 10 11 12 13 14 15 16 17 18 19 21 22 23 24 26 27 28 30 32	 156 S
 IN 19 5 6 7 8 9 10 12 14 17	 175 1.1/2
 1987	 139 -400
 1995	 100 -10
 1990 -5-10	 99 10-3 12-5
 1993 U -10T	 97 -125 -150 -200
 20 4 4,5 5 5,5 6 7 8 9 10 11 13	 98 -125
 2087	 119 -2 -3 -4 -5 -6 -8
 2095	 402
 2098	 404
 2090 -4	 407
 2093 U -3	 640 -1800
 42 2 (5/64AF) 2,5 3 4 5 6 8 10	 132 -200
 60 CP 8	 710
 298 -04	 745
 137 10	 K 1900
 140	 KB 819
	 KB 820
	 880 7 8 9 12
	 885 5 6 8 10
	 890 2 3 4 L
	 4522
	 4534 -3
	 4522
	 4522
	 4522
	 4522
	 4522
	 4522
	 4522
	 4522
	 4522
	 4522
	 4522
	 4522

Contents	Contents
 8000 A 1 A 2 A 11 A 21	 8000 J 1 J 2 J 11 J 21
 8250 -180 JC	 8132 -160 JC
 8132 -160 JC	 8132 AB -160 JC
 8316 -160 JC	 8367 -160 JC
 8551 1 2 3 4 5 6 7 8	 600 H -500
 600 H -500	 248 ST -40
 8701 2-8	 8719 2-8
 8722 2-8	 8725 2-8
 424026	 8728
 8728	2150 3 4 5,5
2153 6,5	2154 6,5 8 10
2160 PZ 1 2 3	2160 PH 1 2 3
2161 PH 1 2	2161 PH 1 2

**S 1151 A****TOOL ASSORTMENT INCH 68 pieces**

- For workshops and service stations
- Recommended hook assortments 1500 HS 1 (24 pcs) or 1500 HS 14 (36 pcs)
- Tools in inch sizes



Code	No.	Contents	
6607280	S 1151 A	68 tools in inch sizes	9.4

Contents	
2 1/4x5/16AF 5/16x3/8AF 3/8x7/16AF 7/16x1/2AF 9/16x5/8AF 19/32x11/16AF 3/4x25/32AF 13/16x7/8AF	
6 1/4x5/16AF 5/16x3/8AF 7/16x1/2AF 9/16x5/8AF 19/32x11/16AF 3/4x25/32AF 13/16x7/8AF 15/16x1AF	
D 19 5/16AF 3/8AF 7/16AF 1/2AF 9/16AF 5/8AF 11/16AF 3/4AF 7/8AF 15/16AF 1AF 1.1/16AF 1.1/4AF	
1990 -3 -5 -10	
1987	
1995	
1993 U -10 T	

Contents	
38 16 [2x]	
42 3/32AF 1/8AF 5/32AF 3/16AF 7/32AF (5,5MM) 1/4AF	
2150 4 6,5 8	
2160 PH 2	
50	
137 10	
145 10 C	
299	
100 -12	
99 10-4	

Contents	
97 -150	
625 A	
4611	
8250 -180 JC	
8316 -160 JC	
8601 1 LBS	

S 1005 A**TOOL ASSORTMENT FOR CONSTRUCTION MACHINES 81 pieces**

- For construction machinery using inch sizes
- Especially suitable for Caterpillar® machines
- Recommended hook assortments 1500 HS 1 (24 pcs) or 1500 HS 3 (36 pcs)
- Tools in inch sizes



Code	No.	Contents	
6600510	S 1005 A	81 tools in inch sizes	22.9

Contents	
1 B 1.1/16AF 1.1/8AF 1.1/4AF 1.5/16AF	
6 1/4x5/16AF 3/8x7/16AF 1/2x9/16AF 19/32x11/16AF 5/8x3/4AF 13/16x7/8AF 15/16x1AF 1.1/16x1.1/8AF 1.1/4x1.3/8AF 1.5/16x1.1/2AF	
7 3/8AF 7/16AF 1/2AF 9/16AF 5/8AF 11/16AF 3/4AF 13/16AF 7/8AF 15/16AF 1AF	
D 19 9/16AF 5/8AF 11/16AF 3/4AF 13/16AF 7/8AF 15/16AF 1AF	
1993 U -10 T	
1990 -5 -10	
1932	
1987	
1995	
1997	
D 30 7/16AF 1/2AF 9/16AF 5/8AF 3/4AF	

Contents	
3090 -3 -5	
3019	
3093 U -10	
D 32 7/8AF 1AF 1.1/16AF 1.1/8AF 1.1/4AF 1.5/16AF 1.1/2AF 1.5/8AF 1.3/4AF	
3290 -8 -16	
3287	
3295	
3293 U -2	
137 10	
145 10 C	
100 -12	
99 10-4 12-8	

Contents	
97 -150 -200	
702 26 A	
36 2-200	
8132 AB -160 JC	
8316 -160 JC	
600 H -1000	
137 -600	
2154 8 12	
2160 PH 2 3	
VDE 2170 5,5	







S 1400 GA



UNIVERSAL TOOL ASSORTMENT INCH 92 pieces



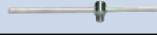

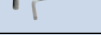
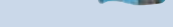

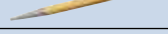
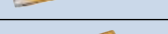



- ✔ Tools in inch sizes
- ✔ Recommended hook assortments 1500 HS 5 (34 pcs), 1500 HS 11 (42 pcs) or 1500 HS 17 (59 pcs)

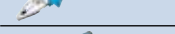

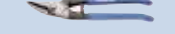
Code	No.	Contents	Wt
6612870	S 1400 GA	92 tools in inch sizes	17.7

Contents	
	2 1/4x5/16AF 5/16x3/8AF 7/16x1/2AF 9/16x5/8AF 19/32x11/16AF 3/4x25/32AF 13/16x7/8AF 15/16x1AF
	6 1/4x5/16AF 5/16x3/8AF 3/8x7/16AF 7/16x1/2AF 1/2x9/16AF 9/16x5/8AF 19/32x11/16AF 5/8x3/4AF 3/4x7/8AF 25/32x13/16AF 15/16x1AF 1.1/16x1.1/8AF
	D 19 3/8AF 13/32AF 7/16AF 1/2AF 9/16AF 19/32AF 5/8AF 11/16AF 3/4AF 25/32AF 13/16AF 7/8AF 15/16AF 1AF 1.1/16AF 1.1/8AF 1.1/4AF
	IS 19 16x2,5
	1993 U -10 T
	1987
	1990 -5 -10
	1995
	42 1/8AF 5/32AF 3/16AF 1/4AF 5/16AF 3/8AF 1/2AF 9/16AF
	2150 4 5,5

Contents	
	2154 6,5 8 10
	2160 PH 2 3
	2133 3/16AF 1/4AF 9/32AF 5/16AF 11/32AF 3/8AF
	60 CP 8
	137 10
	144 7 C
	145 10 C
	100 -10
	99 10 -3 -4
	97 -125 -150
	98 -125
	402
	403

Contents	
	132-150
	8250 -180 JC
	8316 -160 JC
	421025
	225 E -40
	8601 1 LBS
	8701 2-6
	8719 2-6
	8722 2-6
	8728



2005 • 1500 BL



**18
41**

**TOOL PANELS****1450 L****TOOL PANEL for tool assortment, 65 pieces**

- Proposed tool assortment serves as the basic equipment for workshop, garage or hobby
- Further panels can be added in either direction, with special spacers for wall fitting
- Complete with hook assortment 1500 HS 14 and fittings
- Made from solid sheet steel 1.5 mm thick, all 4 edges are bevelled
- Dimensions: L 1000 x H 500 mm
- In GEDORIT blue



Code	No.	Compilation	L	H	Weight
5617110	1450 L	Tool panel empty	1000	500	5.5
6617160	1450 LH	1450 L + hook assortment 1500 HS 14	1000	500	7.3
6617240	1450-1151 M	1450 L + hook assortment 1500 HS 14 + assortment S 1151 M	1000	500	17.3

Contents	
1450 L	2 8x9 10x11 12x13 14x15 16x17 18x19 20x22
	6 6x7 8x9 10x11 12x13 14x15 16x17 18x19 20x22
	19 10 11 12 13 14 15 17 19 22 24 27 30 32
	1990 -3 -5 -10
	1987
	1995
	1993 U -10 T
	38 16 [2x]
	42 2,5 3 4 5 6 8
	2150 4 6,5 8
	2160 PH 2
	50
	137 10

Contents	
	145 10 C
	299
	100 -12
	99 10-4
	97 -150
	625 M
	4611
	8250 -180 JC
	8316 -160 JC
	600 H -500

Contents	
	1500 H 0 -50 [6x]
	1500 H 1 -50 [20x]
	1500 H 2 -13 [6x]
	1500 H 3
	H 6-12 B
	VS 245 H
	VS 19 H

→ 921

487

→ 924







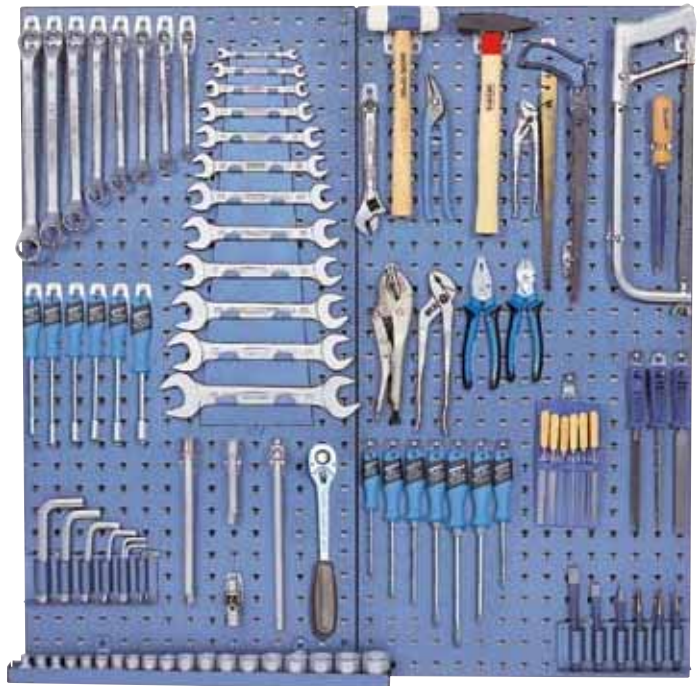





487









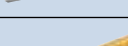





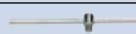

1450 LHG

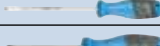





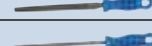





- 2 TOOL PANELS for tool assortment, 100 pieces**
- ✔ Complete with hook assortment 1500 HS 17
 - ✔ Made from solid sheet steel 1.5 mm thick, all 4 edges are bevelled
 - ✔ Dimensions: L 1000 x H 1000 mm
 - ✔ In GEDORIT blue



Code	No.	Compilation	L	H	→
6617590	1450 LHG	2 tool panels 1450 L + hook assortment 1500 HS 17	1000	1000	13.6
6617320	1450-1400 GM	2 tool panels 1450 L + hook assortment 1500 HS 17 + assortment S 1400 GM	1000	1000	30.6

Contents	
	1450 L [2x] 42 1,3 1,5 2 (5/64AF) 2,5 3 4 5 6 8 10
	2 6x7 8x9 10x11 12x13 14x15 16x17 18x19 20x22
	6 6x7 8x9 10x11 12x13 14x15 16x17 18x19 20x22 21x23 24x27
	19 10 11 12 13 14 15 16 17 18 19 21 22 23 24 26 27 28 30 32
	IN 19 6 7 8 9 10 12 14
	142 10 JC
	8132 -160 JC
	8250 -180 JC
	8316 -160 JC
	97 -250
	98 -125
	99 12-5
	100 -12
	119 -1,5 -3 -4

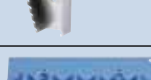
Contents	
	600 H -300
	600 E -500
	225 E -40
	1993 U -10T
	1987
	1995
	1990 -5 -10
	2133 5,5 6 7 8 9 10
	2150 4 5,5 6,5 8
	2160 PH 1 2
	60 CP 8
	137 10
	406
	403
	8701 2-6
	8719 2-6
	8722 2-6
	8728

Contents	
	132 -150
	424026
	1500 E-N L [3x]
	1500 H 0 -50 [15x]
	1500 H 1 -50 [32x]
	1500 H 2 -13 [4x]
	1500 H 3 [2x]
	1500 H 27
	1500 H 27
	1500 H 38
	VS 245 H [2x]
	VS 19 H

**1450 LHGZ****3 TOOL PANELS for tool assortment, 134 pieces**

- With hook assortment 1500 HS 23
- Made from solid sheet steel 1.5 mm thick, all 4 edges are bevelled
- Dimensions: L 1500 x H 1000 mm
- In GEDORIT blue

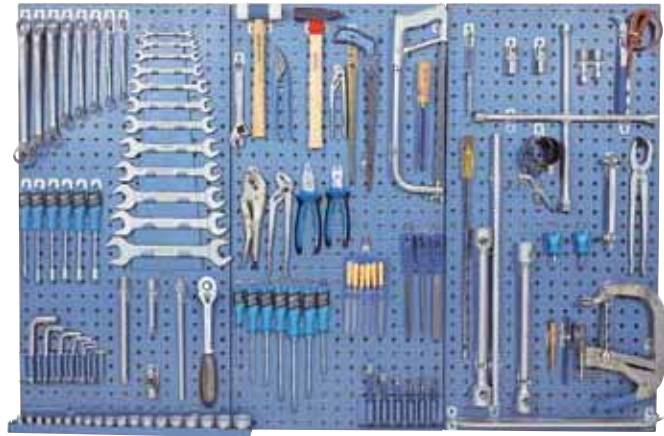

Code	No.	Compilation	L	H	mm
6617670	1450 LHGZ	3 tool panels 1450 L + hook assortment 1500 HS 23	1500	1000	19.7
6617400	1450-1400 GZM	3 tool panels 1450 L + hook assortment 1500 HS 23 + assortments S 1400 GM+S 1400 ZM	1500	1000	46.7









Contents		Contents		Contents	
	1450 L [3x]		137 10		128 2-225
	42 1,3 1,5 2 (5/64AF) 2,5 3 4 5 6 8 10		406		135 13
	2 6x7 8x9 10x11 12x13 14x15 16x17 18x19 20x22		403		299
	6 6x7 8x9 10x11 12x13 14x15 16x17 18x19 20x22 21x23 24x27		8701 2-6		625 M
	19 10 11 12 13 14 15 16 17 18 19 21 22 23 24 26 27 28 30 32		8719 2-6		640 -1800
	IN 19 6 7 8 9 10 12 14		8722 2-6		702 13 M
	142 10 JC		8728		4610
	8132 -160 JC		132 -150		8729 [2x]
	8250 -180 JC		424026		1500 H 0 -50 [17x]
	8316 -160 JC		1500 E-N L [3x]		1500 H 1 -50 [43x]
	97 -250		1990 -2.1/2 -3		1500 H 2 -13 [2x]
	98 -125		INX 19 L 6-100 8-100 10-100 12-100		1500 H 3 [10x]
	99 12-5		2153 6,5		1500 H 27
	100 -12		2161 PH 2		1500 H 38
	119 -1,5 -3 -4		27 24x27 30x32		VS 245 H [2x]
	600 H -300		27 D		VS 19 H
	600 E -500		28 PU CS		
	225 E -40		36 1-140		
	1993 U -10 T		38 20 [2x]		
	1987		50		
	1995		54		
	1990 -5 -10		125 1		
	2133 5,5 6 7 8 9 10				
	2150 4,5 5 6,5 8				
	2160 PH 1 2				
	60 CP 8				

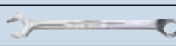





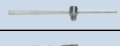



S 1500 ES-01













- MODULE ASSORTMENT SMALL 104 pieces**
- ✔ General basic range for beginners in all professions
 - ✔ Proved GEDORE tool modules from ABS
 - ✔ Ideal for GEDORE tool trolleys



Code	No.	
2319845	S 1500 ES-01	12.1
	1500 ES-1 B	
	1500 ES-19	
	1500 ES-1993 U-20	
	1500 ES-20	
	1500 ES-145	
	1500 ES-350	
	1500 ES-2150 PH	

	Contents
	1 B 6 7 8 9 10 11 12 13 14 15 16 17 18 19 20 21 22
	42 2 (5/64AF) 2,5 3 4 5 6 8 10
	19 10 11 12 13 14 15 16 17 18 19 21 22 23 24 26 27 28 30 32
	IN 19 6 7 8 9 10 12 14
	1993 U -20
	1987
	1995
	1990 -5 -10

	Contents
	20 4 5 5,5 6 7 8 9 10 11 12 13 14
	IN 20 3 4 5 6 8
	TX 20 E4 E5 E6 E7 E8 E10
	ITX 20 T8 T9 T10 T15 T20 T25 T27 T30 T40
	2087
	2090 -4
	2095
	2098
	2093 U -10
	142 10 JC

	Contents
	8132 -160 JC
	8250 -180 JC
	8316 -160 JC
	97 -250
	98 -125
	99 12-5
	100 -12
	119 -1,5 -3 -4
	600 H -300
	2150 4,5,5,6,5,8
	2160 PH 1 2





S 1500 ES-02

MODULE ASSORTMENT MIDDLE 207 pieces

- Basic equipment for the commercial sector or ambitious do-it-yourselfers
- Proved GEDORE tool modules from ABS
- Ideal for GEDORE tool trolleys and work benches



Code	No.	
2319853	S 1500 ES-02	29.1
	1500 ES-1 B	
	1500 ES-6	
	1500 ES-19 IS	
	1500 ES-ITX 19 LKP	
	1500 ES-IN 19 LKM	
	1500 ES-1993 U-20	
	1500 ES-20	
	1500 ES-2133	
	1500 ES-7 R	
	1500 ES-145	
	1500 ES-350	
	1500 ES-711	
	1500 ES-2150 PH	
	1500 ES-K 1900	
	1500 ES-8000	
	1500 ED-70 L [6x]	

	Contents
	1 B 6 7 8 9 10 11 12 13 14 15 16 17 18 19 20 21 22
	42 2 (S/64AF) 2,5 3 4 5 6 8 10
	6 6x7 8x9 10x11 12x13 14x15 16x17 18x19 20x22 21x23 24x27
	19 10 11 12 13 14 15 16 17 18 19 21 22 23 24 26 27 28 30 32
	IS 19 10x1,6 12x2
	IKS 19 2 3 4
	INX 19 8 10
	ITX 19 T20 T25 T27 T30 T40 T45 T50 T55 T60
	ITX 19 L T20-100 T25-100 T27-100 T30-100 T40-100 T45-100 T50-100 T55-100 T60-100
	708

	Contents
	IN 19 5 6 7 8 9 10 12 14 17
	IN 19 L 5-90 6-90 8-90 10-140 12-140 14-140
	1993 U -20
	1987
	1995
	1990 -5 -10
	20 4 5 5,6 7 8 9 10 11 12 13 14
	IN 20 3 4 5 6 8
	TX 20 E4 E5 E6 E7 E8 E10
	ITX 20 T8 T9 T10 T15 T20 T25 T27 T30 T40
	2087
	2090 -4
	2095
	2098
	2093 U -10
	2133 5,5 6 7 8 9 10
	7 R 8 10 12 13 14 15 16 17 18 19
	142 10 JC
	8132 -160 JC
	8250 -180 JC

	Contents
	8316 -160 JC
	97 -250
	98 -125
	99 12-5
	100 -12
	119 -1,5 -3 -4
	600 H -300
	140
	4534 -5
	711
	720
	745
	2150 4,5 5,6 5 8
	2160 PH 1 2
	K 19 10 13 14 17 19
	880 7 8 9 12
	885 5 6 8 10
	890 1 2 3 4
	KB 819
	K 1900
	8000 A 1 2 21
	8000 J 1 2 21
	1500 ED-70 L [6x]





S 1500 ES-03

MODULE ASSORTMENT LARGE 325 pieces

- Extensive industrial range for professionals
- Proved GEDORE tool modules from ABS
- Ideal for GEDORE tool trolleys and work benches



Code	No.	Weight
2319861	S 1500 ES-03	34.8
	1500 ES-1 B	
	1500 ES-19 IS	
	1500 ES-1993 U-20	
	1500 ES-2	
	1500 ES-2 B	
	1500 ES-20	
	1500 ES-20 BIT	
	1500 ES-2133	
	1500 ES-2150 PH	
	1500 ES-2163 BTX	
	1500 ES-34	
	1500 ES-350	
	1500 ES-400	
	1500 ES-6	
	1500 ES-7 R	
	1500 ES-711	
	1500 ES-8000	
	1500 ES-DT 42	
	1500 ES-IN 19 LKM	
	1500 ES-ITX 19 LKM	
	1500 ES-K 1900	
	1500 ES-VDE 145	
	1500 ES-VDE	
	2170 PZ	
	8551-55	
	H 42 KEL-88	
	H 43 KTX-07	
	8728	
	60 P 8	
	137 10	
	4615 3	
	4522	
	1940	
	1500 ED-70 K [3x]	

Contents
1 B 6 7 8 9 10 11 12 13 14 15 16 17 18 19 20 21 22
42 2 (5/64AF) 2,5 3 4 5 6 8 10
19 10 11 12 13 14 15 16 17 18 19 21 22 23 24 26 27 28 30 32
IS 19 10x1,6 12x2
IKS 19 2 3 4
INX 19 8 10
1993 U -20
1987
1995
1990 -5 -10
2 B 6x7 8x9 10x11 12x13 14x15 16x17 18x19 20x22
2 B 6x7 8x9 10x11 12x13 14x15 17x19
20 4 5 5,5 6 7 8 9 10 11 12 13 14
IN 20 3 4 5 6 8
TX 20 E4 E5 E6 E7 E8 E10
ITX 20 T8 T9 T10 T15 T20 T25 T27 T30 T40
2087
2090 -4
2095
2098
2093 U -10
20 L 4,4 5 5 6 7 8 9 10 12 13

Contents
680 4 5,5 6,5 8
685 2,5 3 4 5 6
685 X 5 6 8
687 TX T6 T7 T8 T9 T10 T15 T20 T25 T27 T30 T40
690 1 2 3
690 PZD 1 2 3
649
673 6,3
699
620
676
639
2133 5,5 6 7 8 9 10
2150 4 5,5 6,5 8
2160 PH 1 2
2163 BTX T8 T10 T15 T20 T25 T30
34 8x9 10x11 12x13 14x15 16x17
97 -250
98 -125
99 12-5
100 -12
119 -1,5 -3 -4
600 H -300
400 8x10 10x11 12x14 17x19 13x15
6 6x7 8x9 10x11 12x13 14x15 16x17 18x19 20x22 21x23 24x27
7 R 8 10 12 13 14 15 16 17 18 19
140
4534 -5
708
711
720
745
8000 A 1 2 21

Contents
8000 J 1 2 21
DT 42 2,2 5 3 4 5 6 7 8 10
IN 19 5 6 7 8 9 10 12 14 17
IN 19 L 5-90 6-90 8-90 10-140 12-140 14-140
ITX 19 T20 T25 T27 T30 T40 T45 T50 T55 T60
ITX 19 L T20-100 T25-100 T27-100 T30-100 T40-100 T45-100 T50-100 T55-100 T60-100
708
K 19 10 13 14 17 19
880 7 8 9 12
885 5 6 8 10
890 1 2 3 4
KB 819
K 1900
142 10 C
VDE 8250 -180 H
VDE 8132 -160 H
VDE 8314 -160 H
VDE 2170 4 5,5 6,5 8
VDE 2160 PZ 1 2
8551 1 2 3 4 5
42 KEL 2 2,5 3 4 5 6 8 10
43 KTX T10 T15 T20 T25 T27 T30 T40
8728
60 P 8
137 10
4615 3
4522
1940
1500 ED-70 K [3x]



TOOL MODULES

ES-TOOL MODULES

- Impact resistant ABS
- Oil and acid resistant
- For keeping order in the GEDORE tool trolleys and mobile workbenches with variable divisions

Dimensions:
1/3 module = W 157.5 x D 310 mm

2/3 module = W 315.0 x D 310 mm

- For models 1502, 1504, 2002, 2003, 2004, 2500 please order distance module 1500 ED-70 or 1500 ED-70 K additionally
- For model 1505 please order 1500 ED-150 K additionally
- For model 2005 and 1504 XL please order 1500 ED-70 XL additionally

1500 ES-1 B

COMBINATION SPANNER SET
in 2/3 tool module



Code	No.	↕
6612280	1500 ES-1 B 1 B 6 7 8 9 10 11 12 13 14 15 16 17 18 19 20 21 22 PH 42-88 (2, 2.5 3 4 5 6 8 10)	2790

Code	No.	↕
5620330	1500 E-1B-7 L Tool module empty	250

1500 ES-2

RING SPANNER SET in 1/3 tool module



Code	No.	↕
6621190	1500 ES-2 2 6x7 8x9 10x11 12x13 14x15 16x17 18x19 20x22	1616

Code	No.	↕
5626290	1500 E-2 L Tool module empty	250



For possible combinations of the modules in our tool trolleys and workbenches see page 15



56
-
57

1500 ES-2 B

RING SPANNER SET, SHORT PATTERN
in 1/3 tool module



Code	No.	↕
1731165	1500 ES-2 B 2 B 6x7 8x9 10x11 12x13 14x15 17x19	630

Code	No.	↕
1731173	1500 E-2B-400 L Tool module empty	120

1500 ES-6

OPEN ENDED SPANNER SET
in 1/3 tool module



Code	No.	↕
6621000	1500 ES-6 6 6x7 8x9 10x11 12x13 14x15 16x17 18x19 20x22 21x23 24x27	1702

Code	No.	↕
5626100	1500 E-6-7R L Tool module empty	250

1500 ES-7

COMBINATION SPANNER SET
in 2/3 tool module



Code	No.	↕
6612520	1500 ES-7 7 6 7 8 9 10 11 12 13 14 15 16 17 18 19 20 21 22 PH 42-88 (2, 2.5 3 4 5 6 8 10)	2232

Code	No.	↕
5620330	1500 E-1B-7 L Tool module empty	250

1500 ES-7-32

COMBINATION SPANNER
SET in 2/3 tool module



Code	No.	↕
1761145	1500 ES-7-32 7 23 24 27 30 32	2348

Code	No.	↕
1761153	1500 E-7-32 L Tool module empty	1000

1500 ES-7 R

COMBINATION RATCHET SPANNER SET
in 1/3 tool module



Code	No.	↕
2305429	1500 ES-7 R 7 R 8 10 12 13 14 15 16 17 18 19	1500

Code	No.	↕
5626100	1500 E-6-7R L Tool module empty	250

1500 ES-19

SOCKET SET 1/2", HEXAGON
in 1/3 tool module

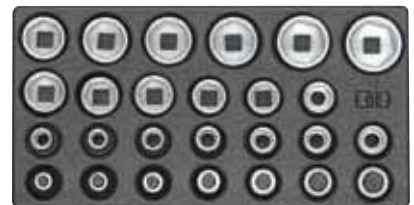

Code	No.	↕
6626580	1500 ES-19 19 10 11 12 13 14 15 16 17 18 19 21 22 23 24 26 27 28 30 32 IN 19 6 7 8 9 10 12 14	2956

Code	No.	↕
5621650	1500 E-19 L Tool module empty	140



1500 ES-D 19

SOCKET SET 1/2", UD PROFILE
in 1/3 tool module



Code	No.	↕
1899694	1500 ES-D 19 D 19 10 11 12 13 14 15 16 17 18 19 21 22 23 24 26 27 28 30 32 IN 19 6 7 8 9 10 12 14	2900
5621650	1500 E-19 L Tool module empty	140

1500 ES-19 IS

SOCKET SET 1/2"
in 1/3 tool module



Code	No.	↕
1733109	1500 ES-19 IS 19 10 11 12 13 14 15 16 17 18 19 21 22 23 24 26 27 28 30 32 IS 19 10x1,6 12x2 IKS 19 2 3 4 INX 19 8 10	2984
5621650	1500 E-19 L Tool module empty	140

1500 ES-IN 19 LKM

SCREWDRIVER BIT SOCKET SET 1/2"
in 1/3 tool module



Code	No.	↕
1402234	1500 ES-IN 19 LKM IN 19 5 6 7 8 9 10 12 14 17 IN 19 L 5-90 6-90 8-90 10- 140 12-140 14-140	2124
1402714	1500 E-IN 19 LKM Tool module empty	150

1500 ES-ITX 19 LKP

SCREWDRIVER BIT SOCKET SET 1/2"
in 1/3 tool module



Code	No.	↕
1402226	1500 ES-ITX 19 LKP ITX 19 T20 T25 T27 T30 T40 T45 T50 T55 T60 ITX 19 L T20-100 T25-100 T27-100 T30-100 T40-100 T45-100 T50-100 T55-100 T60-100 708	2156
1402706	1500 E-ITX 19 LKP Tool module empty	150

1500 ES-K 19 L

SET IMPACT SOCKETS 1/2"
in 1/3 tool module



Code	No.	↕
1640836	1500 ES-K 19 L K 19 L 10 13 14 16 17 18 19 21 22 23 24 27	3394
1643371	1500 E-K 19 L L Tool module empty	120

1500 ES-20

SOCKET SET 1/4"
in 1/3 tool module



Code	No.	↕
6626230	1500 ES-20 20 4 5 5,5 6 7 8 9 10 11 12 13 14 IN 20 3 4 5 6 8 TX 20 E4 E5 E6 E7 E8 E10 ITX 20 T8 T9 T10 T15 T20 T25 T27 T30 T40 2087 2090-4 2095 2098 2093 U-10	1066
5621490	1500 E-20 L Tool module empty	140

1500 ES/CT-20 BIT

TOOL MODULE 1/4"
with assortment

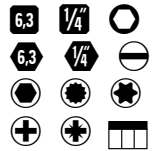

Only suitable for tool trolleys 2003 and 2004, and workbenches 1502, 1504, 1505
Dimensions: W 475 x D 77 x H 40 mm



Code	No.	↕
1733419	1500 ES/CT-20 BIT 20 L 4 4,5 5 6 7 8 9 10 12 13 680 4 5,5 6,5 8 685 2,5 3 4 5 6 685 X 5 6 8 687 TX T6 T7 T8 T9 T10 T15 T20 T25 T27 T30 T40 690 1 2 3 690 PZD 1 2 3 649 673 6,3 699 620 676 639	980

1500 ES-30

SOCKET SET 3/8" in 1/3 tool module



Code	No.	↕
6626070	1500 ES-30 30 6 7 8 9 10 11 12 13 14 15 16 17 18 19 IN 30 4 5 6 8 10 3095 3087 3090-5 -10 3093 U-10	1830
5621220	1500 E-30 L Tool module empty	140

1500 ES-ITX 30

SCREWDRIVER BIT SOCKET SET 3/8"
in 1/3 tool module



Code	No.	↕
1640860	1500 ES-ITX 30 IN 30 L 4 5 6 7 8 10 ITX 30 T20 T25 T27 T30 T40 T45 T50 ITX 30 L T20 T25 T27 T30 T40 T45 T50 TX 30 E5 E6 E7 E8 E10 E11 E12 E14 IS 30 5,5 6,5 8 10 12 IKS 30 1 2 3 IKS 30 PZD 1 2 3	2346
1643363	1500 E-ITX 30 L Tool module empty	140



1500 ES-34
SWIVEL HEAD WRENCH SET
in 1/3 tool module



Code	No.	Unit
6605070	1500 ES-34 34 8x9 10x11 12x13 14x15 16x17	1272
5622890	1500 E-34 L Tool module empty	150

1500 ES-DT 42
HEXAGON SOCKET KEY SET
in 2/3 tool module



Code	No.	Unit
1543474	1500 ES-DT 42 DT 42 2 2,5 3 4 5 6 7 8 10	1337
1543490	1500 E-DT 42 L Tool module empty	270

1500 ES-137
GRIP WRENCH SET
in 1/3 tool module



Code	No.	Unit
2188198	1500 ES-137 137 7 137 10 137 KR-7 138 Y	1970
2188139	1500 E-137 L Tool module empty	140

1500 ES-145
PLIERS SET
in 1/3 tool module

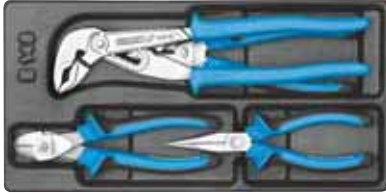

Code	No.	Unit
6614650	1500 ES-145 142 10 JC 8250-180 JC 8132-160 JC 8316-160 JC	1400
5620840	1500 E-145 L Tool module empty	140

1500 ES-VDE 145
VDE PLIERS SET
in 1/3 tool module



Code	No.	Unit
1733079	1500 ES-VDE 145 142 10 C VDE 8250-180 H VDE 8132-160 H VDE 8314-160 H	1320
5620840	1500 E-145 L Tool module empty	140

1500 ES-350
CHISEL SET in 1/3 tool module



Code	No.	Unit
6613760	1500 ES-350 97-250 98-125 99 12-5 100-12 119-1,5 3 4 600 H-300	1818
5620680	1500 E-350 L Tool module empty	140

1500 ES-400
SET FLARE NUT SPANNERS, OPEN
in 1/3 tool module



Code	No.	Unit
1731157	1500 ES-400 400 8x10 10x11 12x14 13x15 17x19	824
1731173	1500 E-2B-400 L Tool module empty	120

1500 ES-534
SET COMBINATION
SWIVEL HEAD WRENCHES
in 1/3 tool module



Code	No.	Unit
1813196	1500 ES-534 534 10 11 13 14 15 17 19 26 RS 1 2	1614
1813226	1500 E-534 L Tool module empty	1400

1500 ES-711
PRECISION MECHANICS
in 1/3 tool module



Code	No.	Unit
1402218	1500 ES-711 140 4534-5 708 711 720 745	972
1402692	1500 E-711 L Tool module empty	150



1500 ES-K 1900

IMPACT DRIVER SET
in 1/3 tool module

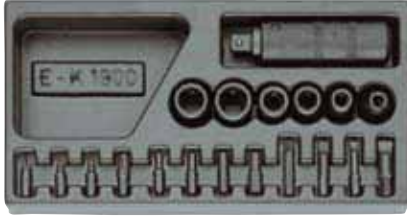

Code	No.	↕
1402242	1500 ES-K 1900 K 19 10 13 14 17 19 880 7 8 9 12 885 5 6 8 10 890 1 2 3 4 KB 819 K 1900	1900

Code	No.	↕
1402722	1500 E-K 1900 L Tool module empty	150

1500 ES-1993 U-20

ACCESSORIES FOR SOCKET WRENCHES 1/2"
in 1/3 tool module



Code	No.	↕
1550756	1500 ES-1993 U-20 1993 U-20 1987 1995 1990-5 -10	1191

Code	No.	↕
5621810	1500 E-1993 L Tool module empty	140

1500 ES-1993 T

ACCESSORIES FOR SOCKET WRENCHES 1/2"
in 1/3 tool module



Code	No.	↕
6626740	1500 ES-1993 T 1993 U-10T 1987 1995 1990-5 -10	1984

Code	No.	↕
5621810	1500 E-1993 L Tool module empty	140

1500 ES-2133

SOCKET WRENCH SET
in 1/3 tool module



Code	No.	↕
1751239	1500 ES-2133 2133 5,5 6 7 8 9 10	1038

Code	No.	↕
1523767	1500 E-2150 L Tool module empty	140

1500 ES-2150 PH

SCREWDRIVER SET
in 1/3 tool module

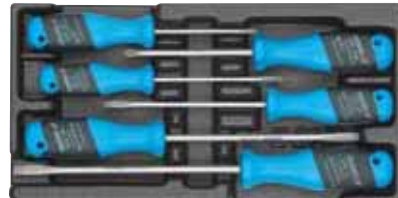

Code	No.	↕
1523708	1500 ES-2150 PH 2150 4 5,5 6,5 8 2160 PH 1 2	820

Code	No.	↕
1523767	1500 E-2150 L Tool module empty	140

1500 ES-2150 PZ

SCREWDRIVER SET
in 1/3 tool module



Code	No.	↕
1523694	1500 ES-2150 PZ 2150 4 5,5 6,5 8 2160 PZ 1 2	846

Code	No.	↕
1523767	1500 E-2150 L Tool module empty	140



1500 ES-2163 BTX

SCREWDRIVER SET
in 1/3 tool module

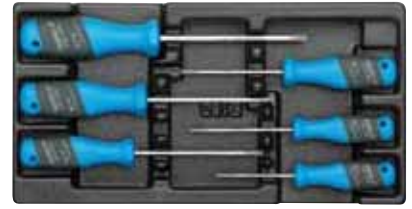

Code	No.	↕
1582666	1500 ES-2163 BTX 2163 BTX T8 T10 T15 T20 T25 T30	638

Code	No.	↕
5621060	1500 E-150 L Tool module empty	140

1500 ES-2163 TXB

SCREWDRIVER SET
in 1/3 tool module



Code	No.	↕
1616625	1500 ES-2163 TXB 2163 TXB T10 T15 T20 T25 T30 T40	724

Code	No.	↕
1523767	1500 E-2150 L Tool module empty	140

1500 ES-VDE 2170 PZ

VDE SCREWDRIVER SET
in 1/3 tool module



Code	No.	↕
1733095	1500 ES-VDE 2170 PZ VDE 2170 4 5,5 6,5 8 VDE 2160 PZ 1 2	846

Code	No.	↕
1523767	1500 E-2150 L Tool module empty	140



1500 ES-8000

CIRCLIP PLIERS in 1/3 tool module

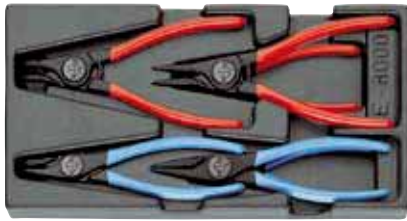

Code	No.	W	D	H	↕	☰
1402196	1500 ES-8000 8000 A 1 A 2 A 21 8000 J 1 J 2 J 21	157.5	310	42	150	1

Code	No.	W	D	H	↕	☰
1446479	1500 E-8000 L Tool module empty	157.5	310	42	150	1

1500 ES-1.07

PULLER SET in 1/3 tool module

- Puller set: 1 cross-beam each 2- and 3-arm pattern (clamping reach 90 mm), 1 spindle, and 3 slim quick-release pulling legs (clamping depth 100 mm)



Code	No.	W	D	H	↕	☰
1933213	1500 ES-1.07 1x 106/103 1x 107/103 1x 1.1406140 3x 106/S100-E	157.5	310	42	150	1

Code	No.	W	D	H	↕	☰
1933248	1500 E-1.07 L Tool module empty	157.5	310	42	150	1

1500 E-N L

TOOL MODULE EMPTY

- Impact resistant ABS, black grained
- Dimensions: W 157.5 x D 310 mm (1/3 module)



Code	No.	W	D	H	↕	☰
5622540	1500 E-N L	157.5	310	42	250	1

1500 E-S L

TOOL MODULE EMPTY

- With compartments for small parts
- Impact resistant ABS, black grained
- Dimensions: W 157.5 x D 310 mm (1/3 module)



Code	No.	W	D	H	↕	☰
1879227	1500 E-S L	157.5	310	42	150	1

1500 ED-30

DISTANCE MODULE EMPTY

- For fixing modules 1500 ES in drawer sizes W 480 x D 350 mm of tool trolleys 3000 TANTO
- Impact resistant ABS, black grained
- Dimensions: W 157 x D 30 x H 42 mm



Code	No.	W	D	H	↕	☰
5626370	1500 ED-30	157	30	42	30	1

1500 ED-70

DISTANCE MODULE WITH SMALL BOXES

- For fixing modules 1500 ES in drawer sizes W 480 x L 400 mm of tool trolleys 2003, 2004, 2500 and workbenches 1502, 1504 and 1505
- Module in sheet steel containing four practical transparent plastic boxes for small parts, lid easily removable, execution L without boxes
- Dimensions: W 475 x D 77 x H 40 mm

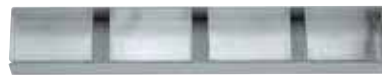

Code	No.	W	D	H	↕	☰
6627120	1500 ED-70	475	77	40	900	1
5627930	1500 ED-70 L	475	77	40	750	1

1500 ED-70 K

DISTANCE MODULE EMPTY

- For fixing modules 1500 ES in drawers with depth 400 mm of tool trolleys 2003, 2004, 2500 and workbenches 1502, 1504 and 1505
- Impact resistant ABS, black grained
- Dimensions: W 475 x D 77 x H 40 mm



Code	No.	W	D	H	↕	☰
1618687	1500 ED-70 K	475	77	40	120	1

1500 ED-70 S

DISTANCE MODULE 1/3 EMPTY

- For tool trolley 2005, workbench 1504 XL and tool chest 2430, suitable as distance piece for module 1/3
- Dimensions: W 152 x D 77 x H 40 mm



Code	No.	W	D	H	↕	☰
1851462	1500 ED-70 S	152	77	40	150	1

1500 ED-70 XL

DISTANCE MODULE EMPTY

- Suitable to take torque wrenches and other long hand tools or small pieces
- Only appropriate to tool trolley 2005 as well as workbench 1504 XL and tool chest 2430
- Dimensions: W 625 x D 77 x H 40 mm



Code	No.	W	D	H	↕	☰
1803069	1500 ED-70 XL	625	77	40	854	1

1500 ED-85

DISTANCE MODULE EMPTY

- Only appropriate to tool trolley 2545 and tool chest 2546
- Dimensions: W 538 x D 85 x H 40 mm



Code	No.	W	D	H	↕	☰
1972588	1500 ED-85	538	85	40	845	1

www.gedore.com

1500 ED-150 K

DISTANCE MODULE EMPTY

- Suitable to take torque wrenches and other long hand tools or small pieces
- Dimensions: W 480 x D 150 x H 42 mm

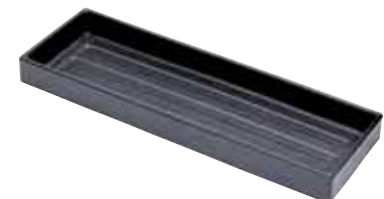

Code	No.	W	D	H	↕	☰
1879243	1500 ED-150 K	480	150	42	150	1



CT-TOOL MODULES

1500 CT2-1 B

CHECK-TOOL INSERT WITH ASSORTMENT



Code	No.	Contents
2308819	1500 CT2-1 B	1 B 6 7 8 9 10 11 12 13 14 15 16 17 18 19 20 21 22 PH 42-88 (2 2,5 3 4 5 6 8 10)

Code	No.	Contents
2322277	EI-1500 CT2-1B L	Check-Tool insert empty

1500 CT1-2

CHECK-TOOL INSERT WITH ASSORTMENT



Code	No.	Contents
2308827	1500 CT1-2	2 B 6x7 8x9 10x11 12x13 14x15 16x17 18x19 20x22

Code	No.	Contents
2322285	EI-1500 CT1-2 L	Check-Tool insert empty

1500 CT1-2 B



Code	No.	Contents
2308843	1500 CT1-2 B	2 B 6x7 8x9 10x11 12x13 14x15 17x19

Code	No.	Contents
2322293	EI-1500 CT1-2B L	Check-Tool insert empty

1500 CT1-6

CHECK-TOOL INSERT WITH ASSORTMENT



Code	No.	Contents
2308851	1500 CT1-6	6 6x7 8x9 10x11 12x13 14x15 16x17 18x19 20x22 21x23 24x27

Code	No.	Contents
2322307	EI-1500 CT1-6 L	Check-Tool insert empty

1500 CT2-7

CHECK-TOOL INSERT WITH ASSORTMENT

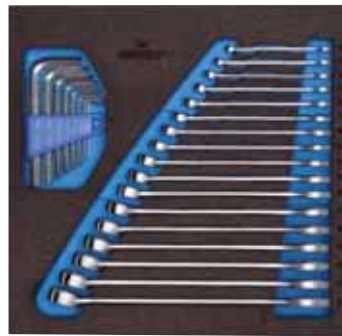

Code	No.	Contents
2308878	1500 CT2-7	7 6 7 8 9 10 11 12 13 14 15 16 17 18 19 20 21 22 PH 42-88 (2 2,5 3 4 5 6 8 10)

Code	No.	Contents
2324164	EI-1500 CT2-7 L	Check-Tool insert empty

1500 CT2-7-32

CHECK-TOOL INSERT WITH ASSORTMENT

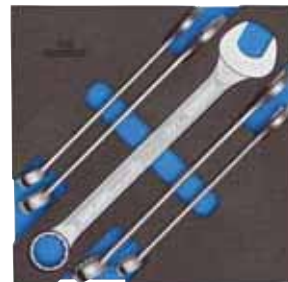

Code	No.	Contents
2308886	1500 CT2-7-32	7 23 24 27 30 32

Code	No.	Contents
2324172	EI-1500 CT2-7-32 L	Check-Tool insert empty

1500 CT1-7 R

CHECK-TOOL INSERT WITH ASSORTMENT

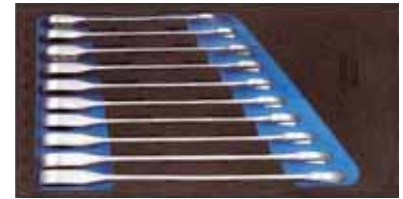

Code	No.	Contents
2308894	1500 CT1-7 R	7 R 8 10 12 13 14 15 16 17 18 19

Code	No.	Contents
2322315	EI-1500 CT1-7R-UR L	Check-Tool insert empty

1500 CT1-7 RA

CHECK-TOOL INSERT WITH ASSORTMENT



Code	No.	Contents
2327686	1500 CT1-7 RA	7 R 8 10 12 13 14 15 16 17 18 19 7 RA -12,5 -10 -6,3 618

Code	No.	Contents
2327708	EI-1500 CT1-7RA-URA L	Check-Tool insert empty

1500 CT1-7 URA

CHECK-TOOL INSERT WITH ASSORTMENT



Code	No.	Contents
2327678	1500 CT1-7 URA	7 UR 8 10 12 13 14 15 16 17 18 19 7 RA -12,5 -10 -6,3 618

Code	No.	Contents
2327708	EI-1500 CT1-7RA-URA L	Check-Tool insert empty



1500 CT1-19
CHECK-TOOL INSERT WITH ASSORTMENT

12,5 1/2" UNIT DRIVE

Code	No.
2308908	1500 CT1-19 19 10 11 12 13 14 15 16 17 18 19 21 22 23 24 26 27 28 30 32 IN 19 6 7 8 9 10 12 14
2322323	EI-1500 CT1-19 L Check-Tool insert empty

1500 CT1-IN 19 LKM
CHECK-TOOL INSERT WITH ASSORTMENT

12,5 1/2" UNIT DRIVE

Code	No.
2308932	1500 CT1-IN 19 LKM IN 19 5 6 7 8 9 10 12 14 17 IN 19 L 5-90 6-90 8-90 10-140 12-140 14-140
2322358	EI-1500 CT1-IN19LKM L Check-Tool insert empty

1500 ES/CT-20 BIT
TOOL MODULE 1/4" with assortment

Only suitable for tool trolleys 2003 and 2004, and workbenches 1502, 1504, 1505
Dimensions: W 475 x D 77 x H 40 mm

6,3 1/4" UNIT DRIVE

Code	No.
1733419	1500 ES/CT-20 BIT 20 L 4 4,5 5 6 7 8 9 10 12 13 680 4 5,5 6,5 8 685 2,5 3 4 5 6 685 X 5 6 8 687 TX T6 T7 T8 T9 T10 T15 T20 T25 T27 T30 T40 690 1 2 3 690 PZD 1 2 3 649 673 6,3 699 620 676 639
	980

1500 CT1-D 19
CHECK-TOOL INSERT WITH ASSORTMENT

12,5 1/2" UNIT DRIVE

Code	No.
2308916	1500 CT1-D 19 D 19 10 11 12 13 14 15 16 17 18 19 21 22 23 24 26 27 28 30 32 IN 19 6 7 8 9 10 12 14
2322323	EI-1500 CT1-19 L Check-Tool insert empty

1500 CT1-ITX 19 LKP
CHECK-TOOL INSERT WITH ASSORTMENT

12,5 1/2" UNIT DRIVE

Code	No.
2308940	1500 CT1-ITX 19 LKP ITX 19 T20 T25 T27 T30 T40 T45 T50 T55 T60 ITX 19 L T20-100 T25-100 T27-100 T30-100 T40-100 T45-100 T50-100 T55-100 T60-100 708
2322366	EI-1500 CT1-ITX19LKP L Check-Tool insert empty

1500 CT1-30
CHECK-TOOL INSERT WITH ASSORTMENT

10 3/8" UNIT DRIVE

Code	No.
2308975	1500 CT1-30 30 6 7 8 9 10 11 12 13 14 15 16 17 18 19 IN 30 4 5 6 8 10 3095 3087 3090-5 -10 3093 U-10
2322382	EI-1500 CT1-30 L Check-Tool insert empty

1500 CT1-19 IS
CHECK-TOOL INSERT WITH ASSORTMENT

12,5 1/2" UNIT DRIVE

Code	No.
2308924	1500 CT1-19 IS 19 10 11 12 13 14 15 16 17 18 19 21 22 23 24 26 27 28 30 32 IS 19 10x1,6 12x2 IKS 19 2 3 4 INX 19 8 10
2322331	EI-1500 CT1-19IS L Check-Tool insert empty

1500 CT1-20
CHECK-TOOL INSERT WITH ASSORTMENT

6,3 1/4" UNIT DRIVE

Code	No.
2308967	1500 CT1-20 20 4 5 5,5 6 7 8 9 10 11 12 13 14 IN 20 3 4 5 6 8 TX 20 E4 E5 E6 E7 E8 E10 ITX 20 T8 T9 T10 T15 T20 T25 T27 T30 T40 2087 2090-4 2095 2098 2093 U-10
2322374	EI-1500 CT1-20 L Check-Tool insert empty

1500 CT1-ITX 30
CHECK-TOOL INSERT WITH ASSORTMENT

10 3/8" UNIT DRIVE

Code	No.
2308983	1500 CT1-ITX 30 IN 30 L 4 5 6 7 8 10 ITX 30 T20 T25 T27 T30 T40 T45 T50 ITX 30 L T20 T25 T27 T30 T40 T45 T50 TX 30 E5 E6 E7 E8 E10 E11 E12 E14 IS 30 5,5 6,5 8 10 12 IKS 30 1 2 3 IKS 30 PZD 1 2 3
2322390	EI-1500 CT1-ITX30 L Check-Tool insert empty



1500 CT1-34

CHECK-TOOL INSERT WITH ASSORTMENT



Code	No.
2308991	1500 CT1-34 34 8x9 10x11 12x13 14x15 16x17
2322404	EI-1500 CT1-34 L Check-Tool insert empty

1500 CT1-VDE 142

CHECK-TOOL INSERT WITH ASSORTMENT



Code	No.
2309033	1500 CT1-VDE 142 142 10 C VDE 8250-180 H VDE 8132-160 H VDE 8314-160 H
2322439	EI-1500 CT1-VDE142 L Check-Tool insert empty

1500 CT1-534

CHECK-TOOL INSERT WITH ASSORTMENT

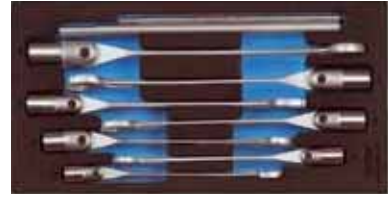

Code	No.
2309076	1500 CT1-534 534 10 11 13 14 15 17 19 26 R5 1 2
2322455	EI-1500 CT1-534 L Check-Tool insert empty

1500 CT2-DT 42

CHECK-TOOL INSERT WITH ASSORTMENT



Code	No.
2309009	1500 CT2-DT 42 DT 42 2 2,5 3 4 5 6 7 8 10
2322412	EI-1500 CT2-DT42 L Check-Tool insert empty

1500 CT1-350

CHECK-TOOL INSERT WITH ASSORTMENT



Code	No.
2309041	1500 CT1-350 97-250 98-125 99 12-5 100-12 119-1,5 3 4 600 H-300
2322447	EI-1500 CT1-350 L Check-Tool insert empty

1500 CT1-711

CHECK-TOOL INSERT WITH ASSORTMENT



Code	No.
2309084	1500 CT1-711 140 4534-5 708 711 720 745
2322463	EI-1500 CT1-711 L Check-Tool insert empty

1500 CT1-142

CHECK-TOOL INSERT WITH ASSORTMENT



Code	No.
2309025	1500 CT1-142 142 10 JC 8250-180 JC 8132-160 JC 8316-160 JC
2322420	EI-1500 CT1-142 L Check-Tool insert empty

1500 CT1-400

CHECK-TOOL INSERT WITH ASSORTMENT



Code	No.
2309068	1500 CT1-400 400 8x10 10x11 12x14 13x15 17x19
2324210	EI-1500 CT1-400 L Check-Tool insert empty

1500 CT1-K 1900

CHECK-TOOL INSERT WITH ASSORTMENT

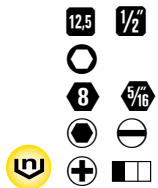

Code	No.
2309092	1500 CT1-K 1900 K 19 10 13 14 17 19 K 19 LS 17 19 21 22 880 7 8 9 12 885 5 6 8 10 890 1 2 3 4 KB 819 K 1900
2322471	EI-1500 CT1-K1900 L Check-Tool insert empty



1500 CT1-1993 U-20
CHECK-TOOL INSERT WITH ASSORTMENT

12,5 1/2"



Code	No.	
2309114	1500 CT1-1993 U-20 1993 U-20 1987 1995 1990-5 -10	
2322498	EI-1500 CT1-1993 L Check-Tool insert empty	

1500 CT1-1993 T
CHECK-TOOL INSERT WITH ASSORTMENT

12,5 1/2"



Code	No.	
2309106	1500 CT1-1993 T 1993 U-10T 1987 1995 1990-5 -10	
2322498	EI-1500 CT1-1993 L Check-Tool insert empty	

1500 CT1-2133
CHECK-TOOL INSERT WITH ASSORTMENT

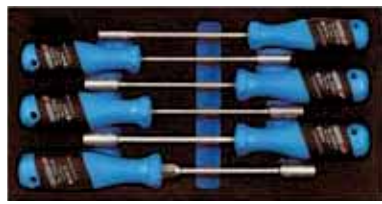

Code	No.	
2309122	1500 CT1-2133 2133 5,5 6 7 8 9 10	
2322501	EI-1500 CT1-2133 L Check-Tool insert empty	

1500 CT1-2150 PH
CHECK-TOOL INSERT WITH ASSORTMENT



Code	No.	
2309130	1500 CT1-2150 PH 2150 4 5,5 6,5 8 2160 PH 1 2	
2322528	EI-1500 CT1-2150 L Check-Tool insert empty	

1500 CT1-2150 PZ
CHECK-TOOL INSERT WITH ASSORTMENT



Code	No.	
2309149	1500 CT1-2150 PZ 2150 4 5,5 6,5 8 2160 PZ 1 2	
2322528	EI-1500 CT1-2150 L Check-Tool insert empty	

1500 CT1-2163 BTX
CHECK-TOOL INSERT WITH ASSORTMENT



Code	No.	
2309157	1500 CT1-2163 BTX 2163 BTX T8 T10 T15 T20 T25 T30	
2322544	EI-1500 CT1-2163BTX L Check-Tool insert empty	

1500 CT1-2163 TXB
CHECK-TOOL INSERT WITH ASSORTMENT



Code	No.	
2309165	1500 CT1-2163 TXB 2163 TXB T10 T15 T20 T25 T30 T40	
2324237	EI-1500 CT1-2163TXB L Check-Tool insert empty	

1500 CT1-VDE 2170 PZ
CHECK-TOOL INSERT WITH ASSORTMENT

1000 V



Code	No.	
2309173	1500 CT1-VDE 2170 PZ VDE 2170 4 5,5 6,5 8 VDE 2160 PZ 1 2	
2322552	EI-1500 CT1-VDE2170PZ L Check-Tool insert empty	

1500 CT1-8000
CHECK-TOOL INSERT WITH ASSORTMENT



Code	No.	
2309181	1500 CT1-8000 8000 A 1 A 2 A 21 8000 J 1 J 2 J 21	
2322560	EI-1500 CT1-8000 L Check-Tool insert empty	

2004 0810



20

Deviant packing units see article description.



15,8	16	17	18	19	20	22	24	27	30	32	36	42	48	54	60	66	72	78	84	90	96	102	108	114	120	126	132	138	144	150	156	162	168	174	180	186	192	198	204	210	216	222	228	234	240	246	252	258	264	270	276	282	288	294	300	306	312	318	324	330	336	342	348	354	360	366	372	378	384	390	396	402	408	414	420	426	432	438	444	450	456	462	468	474	480	486	492	498	504	510	516	522	528	534	540	546	552	558	564	570	576	582	588	594	600	606	612	618	624	630	636	642	648	654	660	666	672	678	684	690	696	702	708	714	720	726	732	738	744	750	756	762	768	774	780	786	792	798	804	810	816	822	828	834	840	846	852	858	864	870	876	882	888	894	900	906	912	918	924	930	936	942	948	954	960	966	972	978	984	990	996	1002	1008	1014	1020	1026	1032	1038	1044	1050	1056	1062	1068	1074	1080	1086	1092	1098	1104	1110	1116	1122	1128	1134	1140	1146	1152	1158	1164	1170	1176	1182	1188	1194	1200	1206	1212	1218	1224	1230	1236	1242	1248	1254	1260	1266	1272	1278	1284	1290	1296	1302	1308	1314	1320	1326	1332	1338	1344	1350	1356	1362	1368	1374	1380	1386	1392	1398	1404	1410	1416	1422	1428	1434	1440	1446	1452	1458	1464	1470	1476	1482	1488	1494	1500	1506	1512	1518	1524	1530	1536	1542	1548	1554	1560	1566	1572	1578	1584	1590	1596	1602	1608	1614	1620	1626	1632	1638	1644	1650	1656	1662	1668	1674	1680	1686	1692	1698	1704	1710	1716	1722	1728	1734	1740	1746	1752	1758	1764	1770	1776	1782	1788	1794	1800	1806	1812	1818	1824	1830	1836	1842	1848	1854	1860	1866	1872	1878	1884	1890	1896	1902	1908	1914	1920	1926	1932	1938	1944	1950	1956	1962	1968	1974	1980	1986	1992	1998	2004	2010	2016	2022	2028	2034	2040	2046	2052	2058	2064	2070	2076	2082	2088	2094	2100	2106	2112	2118	2124	2130	2136	2142	2148	2154	2160	2166	2172	2178	2184	2190	2196	2202	2208	2214	2220	2226	2232	2238	2244	2250	2256	2262	2268	2274	2280	2286	2292	2298	2304	2310	2316	2322	2328	2334	2340	2346	2352	2358	2364	2370	2376	2382	2388	2394	2400	2406	2412	2418	2424	2430	2436	2442	2448	2454	2460	2466	2472	2478	2484	2490	2496	2502	2508	2514	2520	2526	2532	2538	2544	2550	2556	2562	2568	2574	2580	2586	2592	2598	2604	2610	2616	2622	2628	2634	2640	2646	2652	2658	2664	2670	2676	2682	2688	2694	2700	2706	2712	2718	2724	2730	2736	2742	2748	2754	2760	2766	2772	2778	2784	2790	2796	2802	2808	2814	2820	2826	2832	2838	2844	2850	2856	2862	2868	2874	2880	2886	2892	2898	2904	2910	2916	2922	2928	2934	2940	2946	2952	2958	2964	2970	2976	2982	2988	2994	3000
------	----	----	----	----	----	----	----	----	----	----	----	----	----	----	----	----	----	----	----	----	----	-----	-----	-----	-----	-----	-----	-----	-----	-----	-----	-----	-----	-----	-----	-----	-----	-----	-----	-----	-----	-----	-----	-----	-----	-----	-----	-----	-----	-----	-----	-----	-----	-----	-----	-----	-----	-----	-----	-----	-----	-----	-----	-----	-----	-----	-----	-----	-----	-----	-----	-----	-----	-----	-----	-----	-----	-----	-----	-----	-----	-----	-----	-----	-----	-----	-----	-----	-----	-----	-----	-----	-----	-----	-----	-----	-----	-----	-----	-----	-----	-----	-----	-----	-----	-----	-----	-----	-----	-----	-----	-----	-----	-----	-----	-----	-----	-----	-----	-----	-----	-----	-----	-----	-----	-----	-----	-----	-----	-----	-----	-----	-----	-----	-----	-----	-----	-----	-----	-----	-----	-----	-----	-----	-----	-----	-----	-----	-----	-----	-----	-----	-----	-----	-----	-----	-----	-----	-----	-----	-----	-----	-----	-----	-----	-----	-----	-----	-----	-----	-----	------	------	------	------	------	------	------	------	------	------	------	------	------	------	------	------	------	------	------	------	------	------	------	------	------	------	------	------	------	------	------	------	------	------	------	------	------	------	------	------	------	------	------	------	------	------	------	------	------	------	------	------	------	------	------	------	------	------	------	------	------	------	------	------	------	------	------	------	------	------	------	------	------	------	------	------	------	------	------	------	------	------	------	------	------	------	------	------	------	------	------	------	------	------	------	------	------	------	------	------	------	------	------	------	------	------	------	------	------	------	------	------	------	------	------	------	------	------	------	------	------	------	------	------	------	------	------	------	------	------	------	------	------	------	------	------	------	------	------	------	------	------	------	------	------	------	------	------	------	------	------	------	------	------	------	------	------	------	------	------	------	------	------	------	------	------	------	------	------	------	------	------	------	------	------	------	------	------	------	------	------	------	------	------	------	------	------	------	------	------	------	------	------	------	------	------	------	------	------	------	------	------	------	------	------	------	------	------	------	------	------	------	------	------	------	------	------	------	------	------	------	------	------	------	------	------	------	------	------	------	------	------	------	------	------	------	------	------	------	------	------	------	------	------	------	------	------	------	------	------	------	------	------	------	------	------	------	------	------	------	------	------	------	------	------	------	------	------	------	------	------	------	------	------	------	------	------	------	------	------	------	------	------	------	------	------	------	------	------	------	------	------	------	------	------	------	------	------	------	------	------	------	------	------	------	------	------	------	------	------	------	------	------	------	------	------	------	------	------	------	------	------	------	------	------	------	------	------	------	------	------	------	------	------

VANADIUM 19

GEDORE

MADE IN GERMANY

alle siehe Blatt 2.1

18

19

19

19

MADE IN GERMANY













19

19

++ Precise and durable

++ Quality with profile

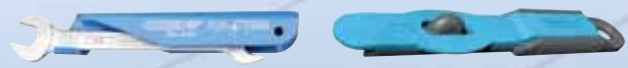

SERVICE / FEATURES		96 - 99
COMBINATION SPANNERS		100 - 103
RATCHET SPANNERS 		104 - 109
OPEN ENDED SPANNERS		110 - 117
DOUBLE ENDED RING SPANNERS		118 - 121
SLOGGING SPANNERS		122 - 126
DEEP RING SPANNERS		127 - 129
CROWFOOT SPANNERS		130
SWIVEL HEAD WRENCHES		130 - 131
SOCKET WRENCHES		132 - 137
MULTI FITTING KEYS		138 - 139
HOOK SPANNERS		140
USEFUL HELPERS		141



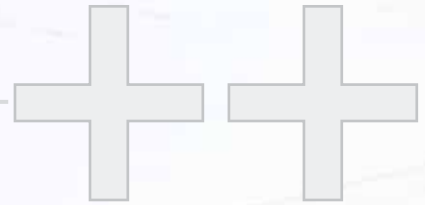

+ A well-functioning extended range

- Extremely large selection in standardised and non-standardised, metric (mm), imperial (AF) and Whitworth (W) sizes
- Top-grade industrial quality for the hardest of continuous use
- Available singly or in practical sets or modules
- Customised manufacturing, designs and types on request



+ Durable and for high loadings

- For heavy continuous use and safety in everyday work
- High bending strength - GEDORE quality spanners do not fracture or splinter when overloaded, but deform under incorrect use, therefore posing a lower risk of injury to the user
- Comfortable to hold due to ergonomic profiles without sharp edges
- Secure grip even with oily hands
- Non-glare look thanks to matt chrome-plating

+ + Precision, correct measurements and perfect fit

- The most important requirements for harmless and safe work
- Complete transmission of available torque
- Long life of nut and bolt
- Profiles easy on the bolt heads (UD, jaw, hexagon)
- Minimum production tolerances ensure that spanners fit perfectly on bolts

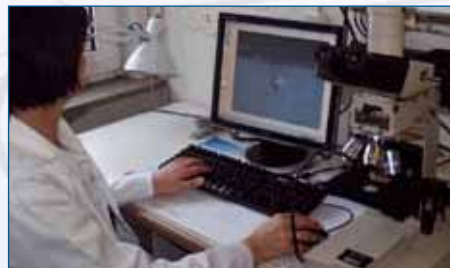

Everything safely under control



- Use of the very best raw materials, state-of-the-art machinery and environmentally-friendly production processes
- Tools without chrome VI have been a given thing for several years
- Our tool experts guarantee precision-like processing and permanent development
- Unique manufacturing processes and special tool treatment for optimum results
- Stringent quality checks after each production step ensure a constantly high level
- Professional service through to development of special customised tools

THE PRODUCTION



OF A SPANNER

From the tool blank to the final product. Quality Comes into Existence - Step by Step.



1 ... High-Quality Steel 31CrV3
Highly-efficient eccentric presses cut the blank for an open-ended spanner from high-quality flat steel.



3 ... Thermally Hardened
Using a special thermal treatment, achieves maximum hardness - and a guarantee of long service life.



2 ... Hot Forging Process
In the pusher furnace, the blank is heated to the exact pre-selected temperature and enters the forge while still red hot. The steel is given its form under the multi-ton blows of a drop hammer.



4 ... Precisely Ground
The jaws of the spanners are given their exact dimensions only after the hardening process. For this purpose, a high-tech grinding robot has been developed especially for this operation.



5 ... Carefully Smoothed
Any corners and edges still remaining are smoothed off by vibratory grinding, until the heads and shaft are absolutely free of burrs. The heads are additionally ground.



6 ... Extensively Treated
The extensive electroplating gives the spanners an effective surface protection and a perfect appearance. During this process, an efficient recycling plant ensures that the environment will not be affected.

+ Why matt chrome-plated?

- ✔ Non-glare look
- ✔ Non-slip surface for a firm grip even when hands are dirty
- ✔ Double protection against corrosion A nickel layer is applied before chrome-plating. Nickel and chrome: these two layers combine to form optimum protection against corrosion.
- ✔ Chrome chips are practically unheard of on matte chrome-plated tools
- ✔ The matte chrome-plated GEDORE finish retains its elegant look for decades



SPANNER MATRIX

Type / Series	Special		mm	"AF	Whitw.		
Combination spanner			3 → 80 mm	1/16" AF → 3.1/4"AF	1/8" W → 3/4"W		
No. 1B			5 - 80 mm	1/4" AF - 3.1/4"AF	1/8"W - 3/4"W		
No. 7			3 - 36 mm	3/16" AF - 1"AF	-		
No. 7XL			7 - 46 mm	-	-		
No. 7R			8 - 36 mm	1/4"AF - 1.1/4"AF	-		
No. 7UR			8 - 24 mm	-	-		
No. 7RXL			13 - 36 mm	-	-		
No. 7RXS			8 - 19 mm	-	-		
No. 7URXL			13 - 24 mm	-	-		
No. 7 URXS			8 - 19 mm	-	-		
Open ended spanner			4 → 135 mm	5/32" AF → 3.7/8"AF	1/8" W → 1.1/2" W		
No. 6			4 x 4,5 - 55 x 60 mm	1/4" x 5/16"AF - 2.1/4" x 2.7/16"AF	1/8"x3/16"W - 7/8"x1"W		
No. 8			4 - 14 mm	5/32"AF - 7/16"AF			
No. 60			0 - 36 mm				
No. 60 P			0 - 36 mm				
No. 62 P			6 - 64 mm				
No. 60 S			0-25 mm				
No. 894			6 - 135 mm	1/4"AF - 3.7/8"AF	1.3/8W x 1.1/2"W		
No. 895			6 x 7 - 75 x 80 mm	1/4" x 5/16"AF - 2.5/8" x 2.13/16"AF			
Ring spanner			5 → 90 mm	1/4" AF → 3.1/8AF	1/8"W → 2"W		
No. 2			5,5 x 7 - 85 x 90 mm	1/4" x 5/16"AF - 3 x 3.1/8"AF	1/8" x 3/16"W - 1.7/8" x 2"W		
No. 2B			6 x 7 - 17 x 19 mm	-	-		
No. TX 4			6 x 8 - 20 x 24 mm				
No. 4			6 x 7 - 46 x 50 mm	1/4" x 5/16"AF - 1/2" x 9/16"AF			
No. 4R				1/4" x 5/16"AF - 1/2" x 9/16"AF			
No. 400			8 x 10 - 46 x 50 mm	5/16" x 3/8"AF - 7/8" x 1"AF			
No. 304		offset 	11 x 13 - 19 x 22mm	7/16" x 1/2"AF - 3/4" x 7/8"AF			
Slogging spanner			22 → 230 mm	7/8"AF → 7.1/2"AF	9/16"W → 3.3/"W		
No. 133			22 - 220 mm	7/8"AF - 6"AF	9/16"W - 3.1/2"W		
No. 306			22 - 230 mm	7/8"AF - 7.1/2"AF	9/16"W - 3.3/4"W		
306 G			27 - 115 mm	1.1/16"AF - 4.5/8AF	9/16"W - 2"W		
Deep ring spanner			33 → 105 mm	7/8"AF → 4.1/8"AF	9/16"W → 2.1/4"W		
308			13 - 95 mm	1.3/16"AF - 3.1/8"AF	9/16"W - 1.3/8"W		
No. 2A			22 - 105 mm	7/8"AF - 4.1/8"AF	9/16"W - 2.1/4"W		



Additional info:

- ▶ GEDORE non-glare, matte chrome-plated, 31CrV3
- ▶ Various standard individual spanners compiled as practical sets
- ▶ Supplied in metal case, module or other holder

- ▶ See respective product in catalogue section for DIN standards and info on material quality
- ▶ Some spanner ranges are hexagonal instead of having a UD profile in the smallest ranges.



THE KEY TO SUCCESS

Hi-tech for the exact rated size

Open-ended spanners have been made since the dawn of technology. But the continued use of traditional tools does not mean that they are still manufactured by conventional production processes. Tried and tested production stages are subject to continuous development by our workforce.

Where modern technology can improve the quality, it is used. GEDORE grinds the spanner jaws to the exact rated size, using a high-tech grinding machine. Perfect fit is the most important requirement for non-damaging and safe work.

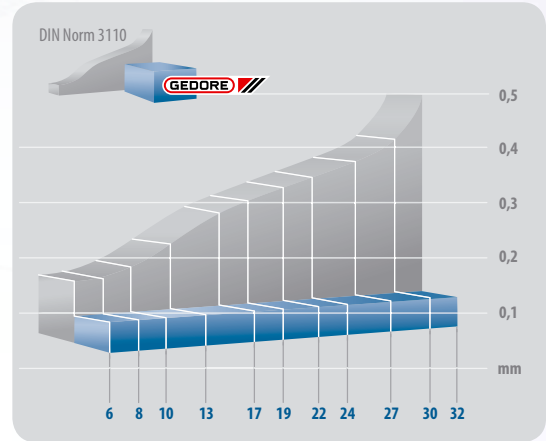
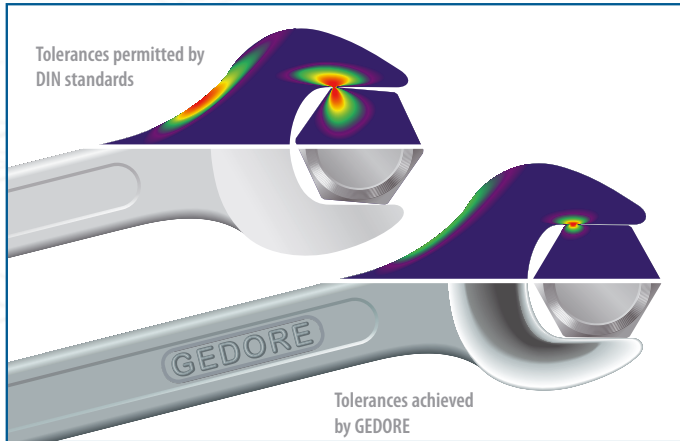

- + Precision dimensions ensure secure nut and bolt grip
- + Long life of nut and bolt
- + Complete transmission of available torque
- + Top quality for better safety



UNIT DRIVE PROFILE (UD PROFILE) protects bolt heads

The GEDORE UNIT-DRIVE profile prevents bolt heads from "spinning" thanks to a wave form without pointed or sharp edges. The enlarged circular contact surfaces displayed by GEDORE tools ensure safe torque transfer with a consistent effect on the bolt head.

The minimised notch effect achieved as a result prevents damage to the bolt head profile - for extra safety as this prevents slipping and spinning, even where bolt heads are already damaged.

GEDORE UNIT-DRIVE profile

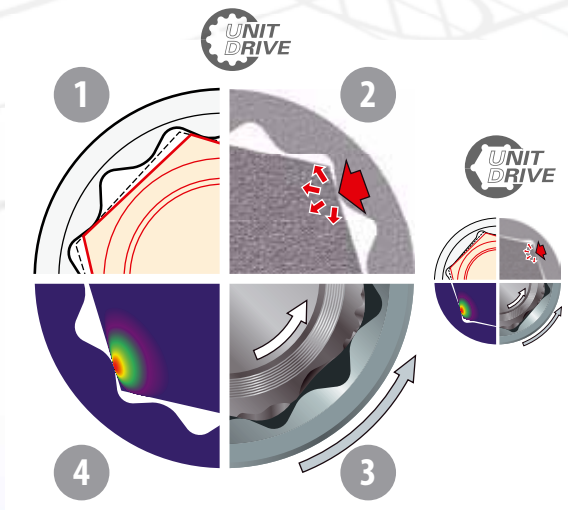

- 1 Larger contact surfaces ensure safe grip even on bolt heads whose dimensions do not conform with the tolerance.
- 2 Even distribution of force across the flats of the bolt heads. This means that the reduced notch effect prevents the bolt head from spinning.
- 3 Even worn bolt heads are safely released thanks to this gentle torque transfer - without the tool slipping.
- 4 Optimum distribution of force enables transfer of up to 20% higher torques.

Standard profile

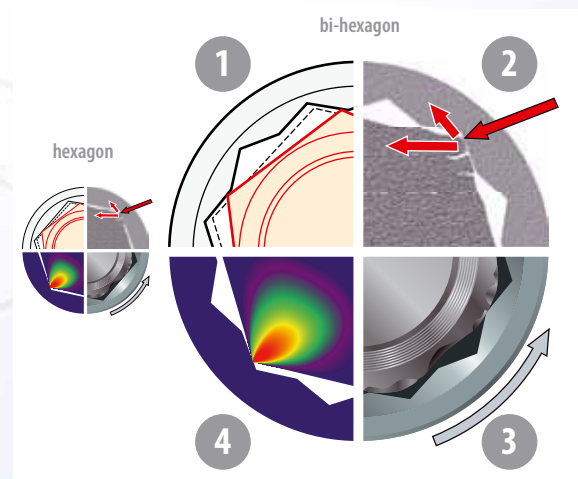

- 1 The smaller contact surface reduces the grip. Safe torque transfer is no longer possible and can represent a danger.
- 2 The sharp edges increase the notch effect on the bolt head. The profile is destroyed.
- 3 Spinning bolt head profiles can no longer be released as the torque is no longer transferred - the tool starts to slip.
- 4 Strong force exerted on the tip of the bolt head profile. Spot pressure deforms the bolt head.



No. 1 B "The strong all-rounder"

- Carefully forged and professionally machined:
- Slim ribbed open end for added strength guarantees maximum torques
- Jaw: ground precisely to exact nominal size for optimum contact areas
- Ring: 10° offset from shaft, with UD profile for gentle transmission of force
- High bending strength - does not fracture or splinter when overloaded, thus minimising the risk of injury
- Overloading indicated by deformation
- Non-glare matt chrome-plated finish
- The offset ring ensures a better grip on deep-seated or inset nuts or bolts.
- Top-grade industrial quality for the hardest of continuous use

Spanner sizes:

- Metric dimensions: 5 - 80 mm
- Imperial dimensions: 1/4" - 3 1/4"
- Whitworth dimensions: 1/8W - 3/4W

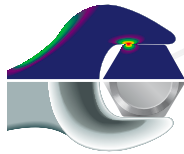
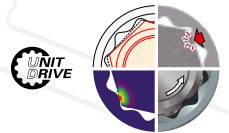

mm	"AF	Whitw.
SW 5 - 80	1/4" - 3 1/4"	1/8" - 3/4"

COMBINATION SPANNERS

1 B

COMBINATION SPANNER with same size each end

- Acc. to DIN 3113 Form B, ISO 3318, ISO 7738
- Ring 10° offset from shaft, extra strong rings but thin wall
- Sizes 5 and 5.5 with hexagon ring, up from size 6 with UD profile
- GEDORE vanadium steel 31CrV3, chrome-plated, polished rings
- * not standardised

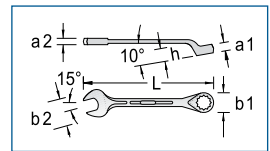

mm

Code	No.	*	W	O mm	L	a ₁	a ₂	b ₁	b ₂	h	±0.1	±0.2
6000240	1 B 5	*	W	5.0	100	5.0	3.4	8.5	14.5	9.5	15	10
6000320	1 B 5,5			5.5	100	5.0	3.4	9.2	14.5	9.5	15	10
6000400	1 B 6	W		6.0	100	5.0	3.4	9.8	15.5	9.5	16	10
6000590	1 B 7			7.0	112	6.0	3.7	11.2	17.2	10.5	28	10
6000670	1 B 8			8.0	125	6.5	4.0	12.5	19.2	11.5	26	10
6000750	1 B 9			9.0	138	7.5	4.3	14.0	21.2	12.5	35	10
6000830	1 B 10			10.0	148	8.2	4.7	15.5	23.5	14.0	42	10
6000910	1 B 11			11.0	158	9.0	5.0	16.8	25.5	15.0	50	10
6001050	1 B 12			12.0	168	9.5	5.3	18.2	27.2	16.0	64	10
6001130	1 B 13			13.0	185	10.2	6.0	19.5	30.0	16.5	80	10
6001210	1 B 14			14.0	198	11.0	6.3	21.0	32.0	17.5	91	10
6001480	1 B 15			15.0	210	11.5	6.7	22.2	34.0	19.0	139	10
6001560	1 B 16			16.0	220	12.0	7.0	23.5	36.0	20.0	128	10
6001640	1 B 17			17.0	232	12.5	7.5	25.0	38.0	21.0	153	10
6001720	1 B 18			18.0	245	13.2	7.7	26.5	40.0	22.5	183	10
6001800	1 B 19			19.0	258	13.5	8.0	27.8	42.0	23.5	210	10
6001990	1 B 20	*		20.0	270	14.5	8.5	29.2	44.0	24.5	245	5
6002020	1 B 21			21.0	280	14.5	8.7	30.5	45.8	26.0	281	5
6002100	1 B 22			22.0	292	14.5	9.0	32.0	48.2	27.0	294	10
6002290	1 B 23	*		23.0	305	15.5	9.3	33.5	49.8	28.0	350	5
6002370	1 B 24			24.0	318	15.5	9.5	35.0	52.0	29.5	372	10
6002450	1 B 25	*		25.0	328	17.5	10.0	36.2	54.2	31.0	431	5

Code	No.	*	W	O mm	L	a ₁	a ₂	b ₁	b ₂	h	±0.1	±0.2
6002530	1 B 26	*		26.0	340	17.5	10.3	37.5	56.0	32.0	481	5
6002610	1 B 27			27.0	352	17.5	10.5	39.0	58.0	33.0	514	10
6002880	1 B 28	*		28.0	370	19.5	11.0	40.2	60.0	34.5	578	1
6002960	1 B 29	*		29.0	370	19.5	11.0	41.8	61.8	34.5	546	1
6003180	1 B 30			30.0	390	19.5	11.2	43.2	63.5	36.0	672	1
6003260	1 B 32			32.0	412	20.5	11.8	46.0	68.0	39.0	684	1
6003340	1 B 33	*		33.0	412	20.5	11.8	47.5	70.5	39.0	827	1
6004150	1 B 34			34.0	412	20.5	11.8	49.0	70.5	39.0	784	1
6003420	1 B 36			36.0	460	23.5	12.8	52.2	76.2	43.0	1147	1
6003500	1 B 38	*		38.0	460	24.2	13.2	56.0	79.2	43.0	1081	1
2006588	1 B 39	*	W	39.0	460	24.2	13.2	56.0	79.2	43.0	1120	1
6003690	1 B 41			41.0	520	25.5	14.0	60.2	85.0	49.0	1452	1
6003770	1 B 46			46.0	550	27.5	15.0	68.0	95.5	53.0	1893	1
2316358	1 B 48	*	W	48.0	520	24.0	15.0	69.0	95.0		1790	1
6003850	1 B 50			50.0	580	29.5	16.0	74.0	103.0	57.0	2268	1
6003930	1 B 55			55.0	620	30.5	17.0	82.0	112.5	62.0	2870	1
2316366	1 B 58	*	W	58.0	610	28.0	18.0	84.5	113.0		3100	1
6004070	1 B 60			60.0	660	32.0	18.0	90.0	121.0	67.0	3600	1
6004660	1 B 65	*	W	65.0	710	33.0	22.0	98.0	133.0	49.5	4415	1
6004740	1 B 70	*		70.0	760	35.0	24.0	105.0	143.0	53.5	5625	1
6004820	1 B 75	*		75.0	810	38.0	26.0	110.0	153.0	57.5	6545	1
6004900	1 B 80	*		80.0	860	41.0	28.0	119.0	163.0	63.5	8790	1

**1 B**

Code	No.	W	O ^{AF}	L	a ₁	a ₂	b ₁	b ₂	h	↕	☰
6005120	1 B 1/4AF	1/4	100	5.0	3.4	10.2	16.2	9.5	16	5	
6005200	1 B 5/16AF	5/16	125	6.5	4.0	12.5	19.2	11.5	27	5	
6005390	1 B 3/8AF	3/8	148	8.2	4.7	14.8	22.2	14.0	45	5	
6005470	1 B 7/16AF	7/16	158	9.0	5.0	17.0	25.8	15.0	53	5	
6005550	1 B 1/2AF	1/2	185	10.2	6.0	19.2	29.2	16.5	85	5	
6005630	1 B 9/16AF	9/16	198	11.0	6.3	21.5	32.0	17.5	99	5	
6005710	1 B 5/8AF	5/8	220	12.0	7.0	23.5	36.0	20.0	136	5	
6005980	1 B 11/16AF	11/16	245	13.2	7.7	25.8	40.0	22.5	192	5	
6006010	1 B 3/4AF	3/4	258	13.5	8.0	27.8	42.0	23.5	209	5	
6006280	1 B 13/16AF	13/16	280	14.5	8.7	30.2	45.8	26.0	269	5	
6006360	1 B 7/8AF	7/8	292	14.5	9.0	32.5	48.2	27.0	308	5	
6006440	1 B 15/16AF	15/16	318	15.5	9.5	34.8	52.0	29.5	403	5	
6006520	1 B 1AF	1	340	17.5	10.3	36.8	55.2	32.0	473	5	
6006600	1 B 1.1/16AF	1.1/16	352	17.5	10.5	39.0	58.0	33.0	559	5	
6006790	1 B 1.1/8AF	1.1/8	370	19.5	11.0	41.0	61.8	34.5	587	5	
6006870	1 B 1.1/4AF	1.1/4	412	20.5	11.8	45.8	70.5	39.0	861	5	
6006950	1 B 1.5/16AF	1.5/16	412	20.5	11.8	48.5	70.5	39.0	789	1	
6007090	1 B 1.3/8AF	1.3/8	460	23.5	12.8	51.5	76.2	43.0	1099	1	
6007170	1 B 1.7/16AF	1.7/16	460	23.5	12.8	53.0	76.2	43.0	1085	1	
6007250	1 B 1.1/2AF	1.1/2	460	24.2	13.2	56.0	79.2	43.0	1113	1	
2316390	1 B 1.9/16AF	1.9/16	470	22.0	13.5	62.0	85.0	42.0	1240	1	

Code	No.	W	O ^{AF}	L	a ₁	a ₂	b ₁	b ₂	h	↕	☰
6007330	1 B 1.5/8AF	1.5/8	520	25.5	14.0	60.5	85.0	49.0	1457	1	
2316374	1 B 1.11/16AF	1.11/16	470	22.0	13.5	62.0	85.0	42.0	1380	1	
6007410	1 B 1.3/4AF	1.3/4	550	27.5	15.0	66.0	95.5	53.0	1896	1	
6007680	1 B 1.13/16AF	1.13/16	550	27.5	15.0	68.0	95.5	53.0	1870	1	
6007760	1 B 1.7/8AF	1.7/8	550	27.5	15.0	69.0	95.5	53.0	1821	1	
2316382	1 B 1.15/16AF	1.15/16	560	26.0	16.5	75.0	103.0	57.0	2210	1	
6007840	1 B 2AF	2	580	29.5	16.0	74.5	103.0	57.0	2280	1	
6007920	1 B 2.1/16AF	2.1/16	580	29.5	16.0	75.0	103.0	57.0	2250	1	
2316412	1 B 2.1/8AF	2.1/8	610	28.0	17.5	80.0	110.0	57.0	2870	1	
6008060	1 B 2.3/16AF	2.3/16	620	30.5	17.0	82.0	112.5	62.0	2855	1	
6008140	1 B 2.1/4AF	2.1/4	620	30.5	17.0	83.0	112.5	62.0	2820	1	
2316439	1 B 2.5/16AF	2.5/16	660	31.0	20.0	90.0	123.0	67.0	3440	1	
6008220	1 B 2.3/8AF	2.3/8	660	32.0	18.0	90.0	121.0	67.0	3510	1	
6008300	1 B 2.7/16AF	2.7/16	660	32.0	18.0	91.0	121.0	67.0	3630	1	
2316404	1 B 2.1/2AF	2.1/2	710	33.0	22.0	98.0	133.0	72.0	4550	1	
2316447	1 B 2.9/16AF	2.9/16	710	33.0	22.0	98.0	133.0	72.0	4550	1	
2316420	1 B 2.3/4AF	2.3/4	760	35.0	24.0	105.0	143.0	75.0	5610	1	
2316455	1 B 3AF	3	810	38.0	26.0	110.0	153.0	81.0	6650	1	
2316471	1 B 3.1/8AF	3.1/8	860	41.0	28.0	119.0	163.0	84.0	8400	1	
2316463	1 B 3.1/4AF	3.1/4	860	41.0	28.0	19.0	163.0	84.0	8400	1	

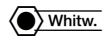
**1 B**

Code	No.	W	L	a ₁	a ₂	b ₁	b ₂	h	↕	☰
6009540	1 B 1/8W	1/8	138	7.5	4.3	13.5	21.2	12.5	35	5
6009620	1 B 3/16W	3/16	158	9.0	5.0	17.5	26.0	15.0	53	5
6009700	1 B 1/4W	1/4	185	10.2	6.0	20.0	30.0	16.5	82	5
6009890	1 B 5/16W	5/16	210	11.5	6.7	22.5	34.0	19.0	115	5
6009970	1 B 3/8W	3/8	245	13.2	7.7	26.5	40.0	22.5	190	5
6010040	1 B 7/16W	7/16	280	14.5	8.7	30.2	45.8	26.0	274	5

Code	No.	W	L	a ₁	a ₂	b ₁	b ₂	h	↕	☰
6010120	1 B 1/2W	1/2	305	15.5	9.3	34.0	50.5	28.0	343	5
6010200	1 B 9/16W	9/16	340	17.5	10.3	37.0	56.0	32.0	477	1
6010390	1 B 5/8W	5/8	370	19.5	11.0	40.2	61.8	34.5	573	1
6010470	1 B 11/16W	11/16	390	19.5	11.2	43.8	65.2	36.0	713	1
6010550	1 B 3/4W	3/4	412	20.5	11.8	48.0	70.5	39.0	803	1

1 B**COMBINATION SPANNER SET**

- Selection of sizes most in use
- Acc. to DIN 3113 Form B, ISO 3318, ISO 7738
- GEDORE vanadium steel 31CrV3, chrome-plated, polished rings
- With same size each end, ring 10° offset from shaft, with UD profile
- WVH = Set in tool holder



WVH 1B-080

Code	No.	Contents	↕	☰
6011870	1 B-08	10 12 13 14 17 19 22 24	2600	1
6011950	1 B-080	8 9 10 11 13 14 17 19	1000	1
1751212	WVH 1 B-080	8 9 10 11 13 14 17 19	830	1
6012250	1 B-011	8 9 10 11 12 13 14 15 17 19 22	1190	1
6013140	1 B-110	7 8 10 11 12 13 14 16 17 18 19	1050	1
6012170	1 B-012	10 11 12 13 14 17 19 22 24 27 30 32	3390	1
6012840	1 B-0112	6 7 8 9 10 11 12 13 14 15 17 19	925	1

Code	No.	Contents	↕	☰
6012410	1 B-015	8 9 10 11 12 13 14 15 16 17 18 19 21 22 23	2060	1
6000160	1 B-0115	6 7 8 9 10 11 12 13 17 19 22 24 27 30 32	3385	1
6012680	1 B-017	6 7 8 9 10 11 12 13 14 15 16 17 18 19 20 21 22	2300	1
6013060	1 B-020	8 9 10 11 12 13 14 15 16 17 18 19 21 22 23 24 26 27 30 32	5500	1
6012920	1 B-026	6 7 8 9 10 11 12 13 14 15 16 17 18 19 20 21 22 23 24 25 26 27 28 29 30 32	7500	1
6013300	1 B-08 A	3/8 7/16 1/2 9/16 5/8 3/4 7/8 1"	1410	1
6013650	1 B-014 A	5/16 3/8 7/16 1/2 9/16 5/8 11/16 3/4 13/16 7/8 1 1.1/16 1.1/8 1.1/4"	3488	1

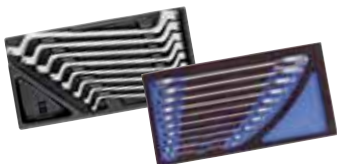
1500 ES / CT

85 - 93

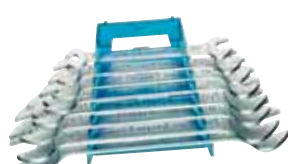
VH 1

46

637

141



No. 7 "Slim line"

- Carefully forged and professionally machined:
- Slim jaw and jaw walls make this spanner lighter overall
- Jaw: ground precisely to exact nominal size for optimum contact areas
- Ring: 15° offset from shaft, with UD profile for gentle transmission of force
- High bending strength - does not fracture or splinter when overloaded, thus minimising the risk of injury
- Overloading indicated by deformation
- Secure grip thanks to hollow shaft - very ergonomic and handy
- Non-glare matt chrome-plated finish
- Designed for universal use
- Top-grade industrial quality for the hardest of continuous use

Spanner sizes:

- Metric dimensions: 3 - 36 mm
- Imperial dimensions: 3/16" - 1"



mm "AF
SW 3 - 36 3/16" - 1"

7

COMBINATION SPANNER with same size each end

- Acc. to DIN 3113 Form A, ISO 3318, ISO 7738
- Ring 15° offset from shaft, shaft in girder pattern
- Sizes 3 to 5.5 with hexagon ring, up from size 6 with UD profile
- GEDORE vanadium steel 31CrV3, chrome-plated, polished rings
- * not standardised



mm

"AF

Code	No.	*	mm	L	a ₁	a ₂	b ₁	b ₂	⚙	📦
6080680	7 3	*	3.0	78	2.8	2.8	6.5	9.2	6	5
6080760	7 3,2	*	3.2	78	2.8	2.8	6.5	9.2	6	5
6080840	7 3,5	*	3.5	78	2.8	2.8	6.5	9.2	6	5
6080920	7 4	*	4.0	85	3.2	3.2	7.7	11.8	10	5
6081060	7 4,5	*	4.5	85	3.2	3.2	7.7	11.8	9	5
6081140	7 5	*	5.0	92	3.6	3.6	9.7	13.2	11	10
6081220	7 5,5	*	5.5	92	3.6	3.6	9.7	13.2	11	10
6089550	7 6		6.0	100	5.0	3.4	10.0	16.2	14	10
6089630	7 7		7.0	110	5.5	3.6	11.5	17.5	17	10
6089710	7 8		8.0	120	6.0	3.8	12.7	19.8	24	10
6089980	7 9		9.0	130	6.5	4.0	14.0	21.5	28	10
6090050	7 10		10.0	140	7.0	4.2	15.5	23.0	33	10
6090130	7 11		11.0	150	7.5	4.5	17.0	26.0	42	10
6090210	7 12		12.0	160	8.0	4.8	18.5	27.5	50	10
6090480	7 13		13.0	170	8.5	5.0	19.5	30.0	58	10
6090560	7 14		14.0	180	9.0	5.2	21.0	31.8	69	10
6090640	7 15		15.0	190	9.5	5.5	22.5	34.0	80	10
6091610	7 16		16.0	200	10.0	5.8	23.0	35.0	92	10
6090720	7 17		17.0	210	10.5	6.0	25.0	38.0	111	10
6091880	7 18		18.0	220	11.0	6.2	26.0	40.0	121	10
6090800	7 19		19.0	230	11.5	6.5	28.0	42.0	140	10
6091960	7 20	*	20.0	240	12.0	6.8	29.0	44.2	170	10
6092180	7 21		21.0	252	12.5	7.0	30.0	45.5	182	10
6090990	7 22		22.0	262	13.0	7.2	32.0	48.0	200	10
6092260	7 23	*	23.0	270	13.5	7.6	33.0	49.5	223	10
6091020	7 24		24.0	282	14.0	8.0	35.0	52.5	264	10
6092340	7 25	*	25.0	290	14.5	8.2	36.0	54.5	295	10
6092420	7 26	*	26.0	302	15.0	8.2	37.0	56.5	309	10
6091100	7 27		27.0	310	15.5	8.5	39.0	59.5	344	10
6092500	7 28	*	28.0	320	16.0	8.8	40.0	60.0	375	10
6092690	7 29	*	29.0	330	16.5	8.8	41.5	61.5	394	10
6091290	7 30		30.0	340	17.0	9.0	43.0	63.0	428	10
6091370	7 32		32.0	370	18.0	9.5	46.0	67.5	535	10
1827987	7 34		34.0	420	19.0	10.0	49.0	72.0	624	1
6089470	7 36		36.0	460	20.0	10.5	52.0	75.0	726	1

Code	No.	"AF	L	a ₁	a ₂	b ₁	b ₂	⚙	📦
1436767	7 3/16AF	3/16	85	3.2	3.2	7.7	11.8	10	1
1436775	7 7/32AF	7/32	92	3.6	3.6	9.7	13.2	11	1
6098700	7 1/4AF	1/4	100	5.0	3.4	10.0	16.2	13	1
6098890	7 5/16AF	5/16	120	6.0	3.8	12.7	19.8	24	1
6098970	7 11/32AF	11/32	130	6.5	4.0	14.0	21.5	26	1
6099190	7 3/8AF	3/8	140	7.0	4.2	15.5	23.0	38	1
6099270	7 7/16AF	7/16	150	7.5	4.5	17.0	26.0	41	1
6099430	7 1/2AF	1/2	170	8.5	5.0	19.5	30.0	56	1
6099510	7 9/16AF	9/16	180	9.0	5.2	21.0	31.8	63	1
6099780	7 5/8AF	5/8	200	10.0	5.8	23.0	35.0	104	1
6099860	7 11/16AF	11/16	220	11.0	6.2	26.0	40.0	122	1
6099940	7 3/4AF	3/4	230	11.5	6.5	28.0	42.0	148	1
6100030	7 13/16AF	13/16	252	12.5	7.0	30.0	45.5	187	1
6100110	7 7/8AF	7/8	262	13.0	7.2	32.0	48.0	192	1
6100380	7 15/16AF	15/16	282	14.0	8.0	34.0	52.5	296	1
6100460	7 1AF	1	302	15.0	8.2	36.0	56.5	287	1

7

COMBINATION SPANNER SET

- Selection of sizes most in use
- Acc. to DIN 3113 Form A, ISO 3318, ISO 7738
- With same size each end
- Ring 15° offset from shaft, shaft in girder pattern
- GEDORE vanadium steel 31CrV3, chrome-plated, polished rings
- VWH = Set in tool holder



Code	No.	Contents	⚙	📦
6092770	7-08	10 12 13 14 17 19 22 24	973	1
6092850	7-080	8 9 10 11 13 14 17 19	536	1
1751220	VWH 7-080	8 9 10 11 13 14 17 19	750	1
6093070	7-011	8 9 10 11 12 13 14 15 17 19 22	868	1
6096090	7-0110	7 8 10 11 12 13 14 16 17 18 19	782	1
6091530	7-0112	6 7 8 9 10 11 12 13 14 15 17 19	686	1
6093150	7-012	10 11 12 13 14 17 19 22 24 27 30 32	2700	1
2190788	7-013	5,5 6 7 8 9 10 11 12 13 14 15 17 19	712	1
6093580	7-017	6 7 8 9 10 11 12 13 14 15 16 17 18 19 20 21 22	1465	1
6093660	7-020	8 9 10 11 12 13 14 15 16 17 18 19 21 22 23 24 26 27 30 32	3360	1
6093740	7-026	6 7 8 9 10 11 12 13 14 15 16 17 18 19 20 21 22 23 24 25 26 27 28 29 30 32	4665	1

"AF

Code	No.	Contents	⚙	📦
6091450	7-08 A	3/8 7/16 1/2 9/16 5/8 3/4 7/8 1"	1047	1



7 XL "Long and extra strong"

- Carefully forged and professionally machined:
- Slim jaw and jaw walls make this spanner lighter overall
- Jaw: ground precisely to exact nominal size for optimum contact areas
- Ring: 15° offset from shaft, with UD profile for gentle transmission of force
- Extra-long shaft for deep applications
- High bending strength - does not fracture or splinter when overloaded, thus minimising the risk of injury
- Overloading indicated by deformation
- Secure grip thanks to hollow shaft - very ergonomic and handy
- Non-glare matt chrome-plated finish
- Ideally suited to extremely tight, high-torque screwed joints
- Top-grade industrial quality for the hardest of continuous use

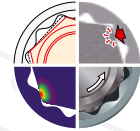

Spanner sizes:

- Metric dimensions: 7 - 46 mm

7 XL

COMBINATION SPANNER with same size each end, extra long

- Similar to DIN 3113
- Ring 15° offset from shaft, with UD profile
- Shaft made in girder pattern
- GEDORE vanadium steel 31CrV3, chrome-plated

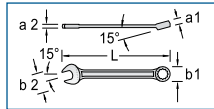

Code	No.	Ø mm	L	a ₁	a ₂	b ₁	b ₂	±	⊞
1394916	7 XL 7	7	160	6.5	4.0	12.5	18.5	31	10
6080090	7 XL 8	8	170	7.0	4.5	13.5	20.8	42	10
6080170	7 XL 9	9	180	7.5	4.5	14.5	22.5	54	10
6097300	7 XL 10	10	190	8.5	5.0	16.0	24.0	11	10
6097490	7 XL 11	11	200	9.0	5.5	17.5	27.0	76	10
6100540	7 XL 12	12	210	10.0	5.5	19.0	28.5	86	10
6100620	7 XL 13	13	225	10.5	6.0	20.0	31.0	102	10
6100700	7 XL 14	14	235	10.8	6.5	22.0	32.8	120	10
6100890	7 XL 15	15	250	11.2	7.0	23.0	35.0	147	10
6080250	7 XL 16	16	265	11.8	7.5	24.8	36.0	171	10
6100970	7 XL 17	17	280	12.2	8.5	26.0	39.0	196	10
6080330	7 XL 18	18	295	13.2	8.5	27.8	41.0	233	10
6101000	7 XL 19	19	310	14.2	9.5	29.0	43.0	276	10

Code	No.	Ø mm	L	a ₁	a ₂	b ₁	b ₂	±	⊞
6080410	7 XL 21	21	340	14.2	9.5	32.5	46.5	352	10
6101190	7 XL 22	22	350	16.2	11.0	33.5	49.0	392	10
1436783	7 XL 23	23	375	17.2	11.5	35.0	50.0	456	10
6101270	7 XL 24	24	400	18.2	12.0	36.5	53.5	521	10
6101350	7 XL 27	27	450	20.2	13.0	40.5	60.5	711	10
6101780	7 XL 30	30	480	21.2	14.0	44.5	63.0	839	1
6101430	7 XL 32	32	500	22.2	14.0	47.5	69.0	956	1
6101860	7 XL 33	33	520	23.2	15.0	48.0	72.0	1117	1
6101940	7 XL 34	34	520	23.2	15.0	50.5	72.0	1088	1
6101510	7 XL 36	36	550	24.2	15.0	53.0	76.0	1248	1
6102080	7 XL 41	41	600	26.0	16.0	62.0	84.5	2000	1
6102160	7 XL 46	46	640	28.0	17.0	70.0	96.0	2278	1

7 XL

COMBINATION SPANNER SET extra long

- Best selling sizes
- Similar to DIN 3113
- With same size each end, ring offset at 15°, with UD profile
- Shaft made in girder pattern
- GEDORE vanadium steel 31CrV3, chrome-plated



Code	No.	Contents	±	⊞
6104880	7 XL-080	8 9 10 11 13 14 17 19	962	1
6104960	7 XL-0111	8 10 11 12 13 14 16 17 18 19 22	1794	1
6095950	7 XL-012	10 11 12 13 14 17 19 22 24 27 30 32	4410	1



Optional accessories

1500 ES / CT

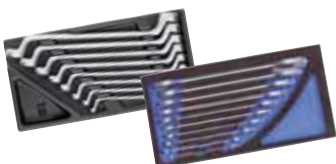

85 - 93

636



141

637



141

The revolution
A perfect collection

ALL THE BENEFITS...



OF THE GEDORE U-20 TECHNOLOGY,

CLASSIC NO. 6 AND THE SLIM,

TRIED-AND-TESTED NO. 7

Schlüsselknarre[®]
R-Serie

7R
&
7UR

... HAVE BEEN COMBINED INTO THESE RATCHET WRENCHES 7 R + 7 UR:



The hollow shaft (No. 7)

... highly stable - ideal for transferring maximum forces

The kind-to-hands hollow profile makes for easy and tireless bolting. The GEDORE hollow profile has a geometry similar to that of a double T-girder. This makes it possible for substantial forces - particularly with large spanner sizes (34 and 36 mm) - to be transferred.



The jaw (No. 6)

... highly dimensionally accurate / extremely precise - for non-damaging and safe working

The exact nominal dimension of the jaw and thus its fitting precision ensure a secure bolt fitting and long service life of both bolt and ratchet wrench - the most important requirement, in fact, for non-damaging and safe working.



The non-glare look with grip (No. 6 & 7)
... an extremely assured grip thanks to the surface profile - matt chrome-plated

The spanner surface is designed for both practical application and eye-appeal. The non-glare look comes from matt chrome-plating - the GEDORE surface profile is both kind-on-hands and very useful - a firm grip even with oily hands.

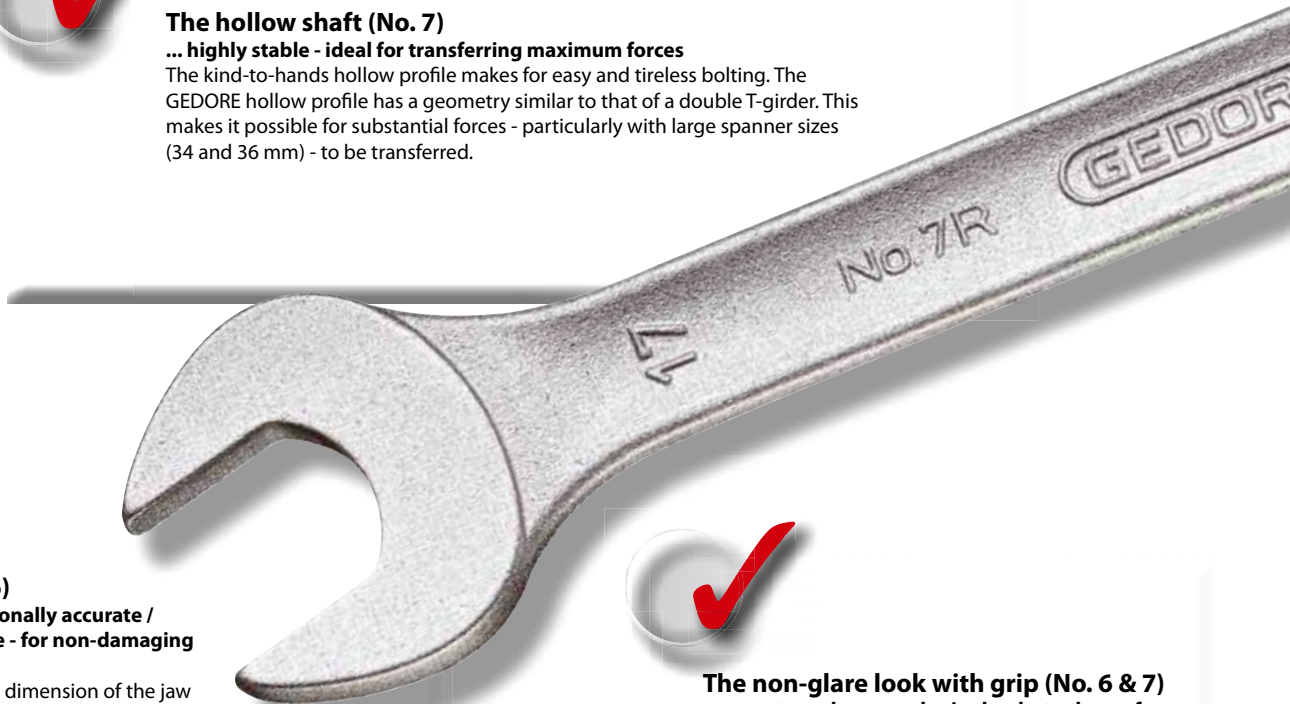



The ratchet (U-20)

... extra flat and sturdy - ideal for tough use and even at hard-to-reach areas

Extremely compact and highly efficient - for quick deployments and also under cramped conditions. The tried-and-tested U-20 ratchet technology incorporated in an extremely flat ring head ensures efficient ratcheting work - For both loosening and fast tightening. The sturdiness of the ratchet wrench is very much down to the number of teeth intentionally selected. The GEDORE pawl geometry optimises the actually large working angle occasioned by a small number of teeth.



The UD profile (No. 7)

... extremely easy on the bolt heads with the force ideally transferred

The wave form of the profile enlarges the spanner grip in every case - even with bolts whose dimensions are outside the tolerance range. Even distribution of pressure permits the maximum force to be applied.

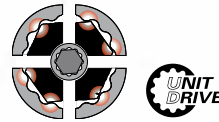

The working angle

... extremely rapid deployment even in very confined spaces thanks to its very small working angle

With an immediate meshing mechanism, GEDORE has managed to reduce the play between pawl and locking insert to practically nothing. This refinement of the ratchet technology has produced a very small, yet effective working angle. This means a reduction to a minimum of the spanner dead operating angle. The spanner starts off with active power where others are still at idle.

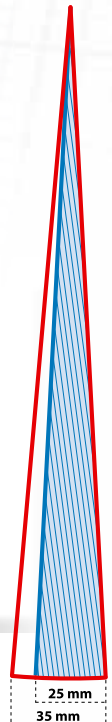

GEDORE 25 mm* 
conventional spanner 35 mm* 

for 19 mm



Long life cycle

...precise and reliable, environment and maintenance-friendly

The fact that the ratchet wrench can be serviced underpins its sustainability. Even after any instance of incorrect use (e.g. given considerable soiling, overstressing or moisture...) the ratchet wrench can be quickly made operable. Unscrew, slight re-greasing, screw down - and then continue to reliably undo the bolts.





THE PRODUCTION OF A RATCHET WRENCH

From the tool blank to the final product

Quality Comes into Existence - Step by Step "Made in Germany"

- 1 **... high-quality steel 31CrV3, ideal for hand tools**
Highly-efficient eccentric presses cut the blank for a ratchet wrench from high-quality flat steel. The coming shape, powerful heads and slim shaft can even be recognised at this stage.
- 2 **... hot forging process**
In the forging furnace the blank is heated to the exact pre-selected temperature and enters the forge while still red hot. The steel is given its form in the die under the multi-ton blows of a drop hammer. Any excess steel at the sides is then de-burred.
- 3 **... machined**
The ratchet head is brought to the precise dimension in a CNC machining centre.
- 4 **... tempering**
A special thermal treatment involving inert gas provides the tool with its extreme hardness and toughness - indispensable for a particularly long service life. Hardening ensures the required hardness and the annealing which follows imparts that toughness to the ratchet wrench body. Hardening and annealing together are referred to as tempering.
- 5 **... precisely ground**
The jaws of the spanners are given their exact dimensions only after the hardening process. For this purpose, a high-tech grinding robot has been developed especially for this operation.
- 6 **... smoothed in a kind-to-hands manner**
After grinding has produced a clean-cut, burr-free outer surface for our ratchet wrench bodies, any corners and edges still remaining are smoothed off by vibratory grinding until the head and shaft are likewise absolutely clean-cut and burr-free. The heads are additionally ground. This gives rise to GEDORE's kind-on-hands haptics.
- 7 **... extensively treated**
The extensive electroplating gives the spanners an effective surface protection and a perfect appearance. Nickel-plating provides the ratchet wrench body with optimal corrosion protection and the non-glare finish comes from high-grade matt chrome-plating.



THE PRODUCTION OF A RATCHET INSERT

- 8 **... high-quality steel brought precisely into shape**
High-quality GEDORE special hardened and tempered steel brought precisely into shape on the most up-to-date CNN machining centres.
- 9 **... unmistakable profile**
The unmistakable, easy-on-bolts Unit Drive Profile (UD) is precisely reamed to size on highly-efficient reaming presses. Tempering is followed by the screw insert being manganese-phosphated. It protects from corrosion and lessens friction-induced wear.



MERGING

- 10 **... marriage** 
Ratchet wrench body, screw insert, cap and mechanisms are assembled. (Technicians traditionally refer to this as the marriage process.) This is accompanied at the same time by the functional check. Coming into play very much here is the knowledge and extensive track record of our staff. And ready is the GEDORE ratchet wrench - made by GEDORE - made in Germany!





7 R

COMBINATION RATCHET SPANNER

- With same size each end
- Flat pattern
- UD profile
- Working angle: 7° from 8 to 15 mm, 6° from 16 to 27 mm and 5° from 30 to 36 mm
- For ratchet loosening and fast tightening
- High torque transfer
- Hollow profile comfortable to hold
- Warp-resistant geometry with double T-girder effect
- GEDORE vanadium steel 31CrV3
- Non-glare look thanks to matt chrome-plating, locking insert and pawl manganese-phosphated
- Hot forged
- Jaw exactly ground to spanner size
- Tried-and-tested GEDORE technology combined anew: spanner jaws of classic No. 6, stable hollow shaft of No. 7 and refined mechanism of the U-20 ratchets
- In combination with adaptor 7 RA or 7 RB (order separately) the spanner 7 R can be used as a (bit) ratchet



Spanner sizes:

- Metric dimensions: 8 - 36 mm
- Imperial dimensions: 1/4" - 1 1/4"

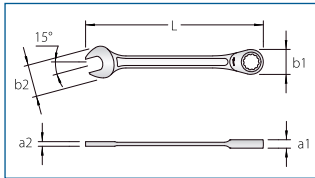

Code	No.	Ø mm	∠°	L	a ₁	a ₂	b ₁	b ₂	🔧	📦
2297051	7 R 8	8	7	140	7.0	3.8	17.5	19.8	32	5
2297078	7 R 9	9	7	150	7.3	4.0	19.3	21.5	42	5
2297086	7 R 10	10	7	160	7.7	4.2	21.0	23.0	54	5
2297094	7 R 11	11	7	164	8.1	4.5	22.5	26.0	63	5
2297108	7 R 12	12	7	170	8.6	4.8	23.6	27.5	69	5
2297116	7 R 13	13	7	180	9.0	5.0	25.7	30.0	88	5
2297124	7 R 14	14	7	190	9.4	5.2	28.2	31.8	101	5
2297132	7 R 15	15	7	200	9.8	5.5	29.5	34.0	125	5
2297140	7 R 16	16	6	212	10.2	5.8	31.7	35.0	137	5
2297159	7 R 17	17	6	225	10.6	6.0	33.6	38.0	160	5
2297167	7 R 18	18	6	237	11.0	6.2	34.6	40.0	197	5
2297175	7 R 19	19	6	250	11.7	6.5	36.3	42.0	202	5
2219433	7 R 21	21	6	274	12.5	7.0	40.0	45.5	262	1
2297191	7 R 22	22	6	292	13.3	7.2	42.5	48.0	319	1
2297205	7 R 24	24	6	325	14.8	8.0	48.0	52.5	520	1
2297213	7 R 27	27	6	359	16.0	8.5	53.5	59.5	590	1
2297221	7 R 30	30	5	399	17.4	9.0	59.0	63.0	780	1
2297248	7 R 32	32	5	424	17.9	9.5	63.0	67.5	920	1
2219549	7 R 34	34	5	449	18.4	10.0	65.5	72.0	1010	1
2219557	7 R 36	36	5	480	18.9	10.5	70.0	75.0	1208	1



Code	No.	Ø AF	L	a ₁	a ₂	b ₁	b ₂	🔧	📦
1995863	7 R 1/4AF	1/4	128	6.3	3.9	14.0	15.0	24	1
1995871	7 R 5/16AF	5/16	140	6.5	4.0	16.6	16.7	28	1
1995898	7 R 3/8AF	3/8	159	7.3	4.8	20.0	20.8	48	1
1995901	7 R 7/16AF	7/16	165	7.7	5.2	21.8	23.0	10	1
1995928	7 R 1/2AF	1/2	178	8.6	5.8	24.7	27.1	82	1
1995936	7 R 9/16AF	9/16	191	9.0	6.2	27.0	29.2	102	1
1995944	7 R 5/8AF	5/8	208	9.9	6.8	30.0	33.4	139	1
1995952	7 R 3/4AF	3/4	248	11.2	8.2	33.8	39.7	220	1
1995960	7 R 7/8AF	7/8	290	13.0	9.0	40.0	46.0	350	1
1995979	7 R 1AF	1	323	14.5	10.0	46.0	52.2	490	1
1995987	7 R 1.1/16AF	1.1/16	359	15.5	10.5	52.5	56.5	660	1
1995995	7 R 1.1/8AF	1.1/8	403	17.0	11.4	58.5	62.7	860	1
1996002	7 R 1.1/4AF	1.1/4	425	17.5	12.5	62.5	66.4	1100	1

Deviant packing units see article description.

7 R-005

COMBINATION RATCHET SPANNER SET 5 pieces

- Most used sizes combined in a set
- Flat pattern
- UD profile
- High torque transfer
- In plastic case
- Dimensions: 275 x 150 x 42 mm



Code	No.	Contents	🔧	📦
2297434	7 R-005	7 R 8 10 13 17 19	932	1

7 R-012

COMBINATION RATCHET SPANNER SET 12 pieces

- Most used sizes combined in a set
- Flat pattern
- UD profile
- High torque transfer
- In robust sheet-metal case
- Dimensions: 315 x 181 x 40 mm



Code	No.	Contents	🔧	📦
2297442	7 R-012	7 R 8 9 10 11 12 13 14 15 16 17 18 19	2840	1





7 R XL

COMBINATION RATCHET SPANNER extra long

- With same size each end
- Flat pattern
- UD profile
- Working angle: 7° from 13 to 15 mm, 6° from 16 to 27 mm and 5° from 30 to 36 mm
- For ratchet loosening and fast tightening
- High torque transfer
- Long lever arm for powerful screwing, 33% longer than standard spanners
- Hollow profile comfortable to hold
- Warp-resistant geometry with double T-girder effect
- GEDORE vanadium steel 31CrV3
- Non-glare look thanks to matte chrome-plating, locking insert and pawl manganese-phosphated
- Hot-forged
- Jaw exactly ground to spanner size
- Tried-and-tested GEDORE technology combined anew: solid spanner jaws of classic No. 7 XL, stable hollow shaft of No. 7 and refined mechanism of the U-20 ratchets

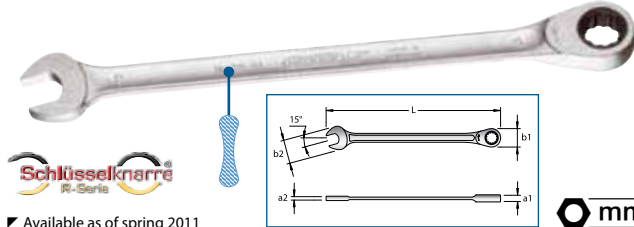

Available as of spring 2011

Code	No.	Ø mm	∠°	L	a ₁	a ₂	b ₁	b ₂	↺	↻
2300265	7 R XL 13	13	7	240	12.0	6.0	26.5	30.6		1
2300281	7 R XL 14	14	7	253	12.5	6.5	29.1	32.7		1
2300303	7 R XL 15	15	7	265	13.0	7.0	30.5	34.8		1
2300311	7 R XL 16	16	6	282	13.6	7.5	32.8	35.9		1
2300338	7 R XL 17	17	6	300	14.1	8.5	34.7	39.0		1
2300346	7 R XL 18	18	6	315	14.6	9.0	35.8	41.1		1
2300354	7 R XL 19	19	6	333	15.6	9.5	37.5	43.2		1
2300362	7 R XL 21	21	6	353	16.6	10.0	41.4	46.8		1
2300370	7 R XL 22	22	6	388	17.7	11.0	43.6	49.4		1
2300389	7 R XL 24	24	6	432	19.7	12.0	49.2	54.0		1
2300397	7 R XL 27	27	6	478	21.3	13.0	54.2	61.1		1
2300400	7 R XL 30	30	5	530	23.1	14.0	59.6	64.7		1
2300419	7 R XL 32	32	5	564	23.8	14.5	63.7	69.3		1
2300427	7 R XL 36	36	5	638	25.1	15.5	71.4	77.0		1

7 R XS

COMBINATION RATCHET SPANNER extra short

- With same size each end
- Flat pattern
- UD profile
- Working angle: 7° from 8 to 15 mm and 6° from 16 to 19 mm
- For ratchet loosening and fast tightening
- High torque transfer
- Hollow profile comfortable to hold
- Warp-resistant geometry with double T-girder effect
- GEDORE vanadium steel 31CrV3
- Non-glare look thanks to matte chrome-plating, locking insert and pawl manganese-phosphated
- Hot-forged
- Jaw exactly ground to spanner size
- Tried-and-tested GEDORE technology combined anew: solid spanner jaws of classic No. 7 XL, stable hollow shaft of No. 7 and refined mechanism of the U-20 ratchets

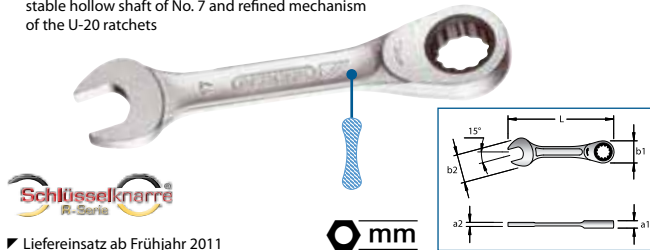

Liefereinsatz ab Frühjahr 2011

Code	No.	Ø mm	∠°	L	a ₁	a ₂	b ₁	b ₂	↺	↻
2304163	7 R XS 8	8	7	94	7.0	3.8	17.5	18.5		1
2304198	7 R XS 9	9	7	99	7.3	4.0	19.3	19.8		1
2304201	7 R XS 10	10	7	104	7.7	4.2	21.0	21.5		1
2304236	7 R XS 11	11	7	110	8.1	4.5	22.5	23.0		1
2304244	7 R XS 12	12	7	117	8.6	4.8	23.6	26.0		1
2304252	7 R XS 13	13	7	123	9.0	5.0	25.7	27.5		1
2304260	7 R XS 14	14	7	129	9.4	5.2	28.2	30.0		1
2304279	7 R XS 15	15	7	136	9.8	5.5	29.5	31.8		1
2304295	7 R XS 16	16	6	144	10.2	5.8	31.7	34.0		1
2304325	7 R XS 17	17	6	152	10.6	6.0	33.6	35.0		1
2304341	7 R XS 18	18	6	160	11.0	6.2	34.6	38.0		1
2304368	7 R XS 19	19	6	169	11.7	6.5	36.3	40.0		1

7 UR

COMBINATION RATCHET SPANNER, REVERSIBLE

- With same size each end
- Ring 13° offset from shaft
- UD profile
- Working angle 7° from 8 to 15 mm, and 6° from 16 to 24 mm
- For ratchet loosening and fast tightening, with lever change
- High torque transfer
- Hollow profile comfortable to hold
- Warp-resistant geometry with double T-girder effect
- GEDORE vanadium steel 31CrV3
- Non-glare look thanks to matt chrome-plating, locking insert and pawl manganese-phosphated
- Hot forged
- Jaw exactly ground to spanner size
- Tried-and-tested GEDORE technology combined anew: spanner jaws of classic No. 6, stable hollow shaft of No. 7 and refined mechanism of the U-20 ratchets
- In combination with adaptor 7 RA or 7 RB (order separately) the spanner 7 UR can be used as a (bit) ratchet

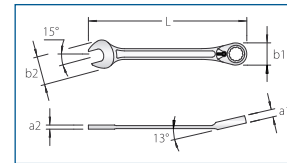
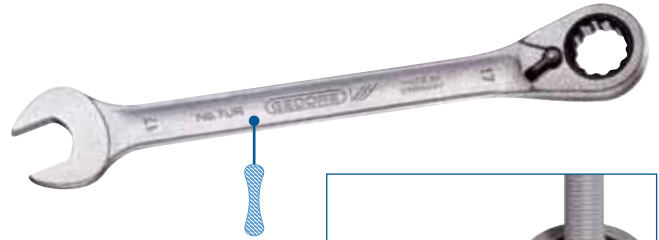

Code	No.	Ø mm	∠°	L	a ₁	a ₂	b ₁	b ₂	↺	↻
2297256	7 UR 8	8	7	140	7.0	3.8	17.5	19.8	37	1
2297264	7 UR 9	9	7	150	7.3	4.0	19.3	21.5	43	1
2297272	7 UR 10	10	7	160	7.7	4.2	21.0	23.0	53	1
2297280	7 UR 11	11	7	164	8.1	4.5	22.5	26.0	62	1
2297299	7 UR 12	12	7	170	8.6	4.8	23.6	27.5	69	1
2297302	7 UR 13	13	7	180	9.0	5.0	25.7	30.0	81	1
2297310	7 UR 14	14	7	190	9.4	5.2	28.2	31.8	98	1
2297329	7 UR 15	15	7	200	9.8	5.5	29.5	34.0	120	1
2297337	7 UR 16	16	6	212	10.2	5.8	31.7	35.0	153	1
2297345	7 UR 17	17	6	225	10.6	6.0	33.6	38.0	166	1
2297353	7 UR 18	18	6	237	11.0	6.2	34.6	40.0	178	1
2297361	7 UR 19	19	6	250	11.7	6.5	36.3	42.0	218	1
2244500	7 UR 21	21	6	274	12.5	7.0	40.0	45.5	264	1
2297388	7 UR 22	22	6	292	13.3	7.2	42.5	48.0	319	1
2297396	7 UR 24	24	6	325	14.8	8.0	48.0	52.5	449	1



Deviant packing units see article description.



7 UR-012

COMBINATION RATCHET SPANNER SET, REVERSIBLE 12 pieces

- Most used sizes
- Ring 13° offset from shaft, reversible
- UD profile
- High torque transfer
- In robust sheet-metal case
- Dimensions: 315 x 181 x 40 mm



mm

Code	No.	Contents	2840	1
2297418	7 UR-012	7 R 8 9 10 11 12 13 14 15 16 17 18 19	2840	1

7 UR XL

COMBINATION RATCHET SPANNER extra long

- With same size each end
- UD profile
- Ring 13° offset from shaft
- Working angle: 7° from 13 to 15 mm and 6° from 16 to 24 mm
- For ratchet loosening and fast tightening, with lever change
- High torque transfer
- Long lever arm for powerful screwing, 33% longer than standard spanners
- Hollow profile comfortable to hold
- Warp-resistant geometry with double T-girder effect
- GEDORE vanadium steel 31CrV3
- Non-glare look thanks to matte chrome-plating, locking insert and pawl manganese-phosphated
- Hot-forged
- Jaw exactly ground to spanner size
- Tried-and-tested GEDORE technology combined anew: solid spanner jaws of classic No. 7 XL, stable hollow shaft of No. 7 and refined mechanism of the U-20 ratchets

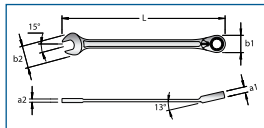
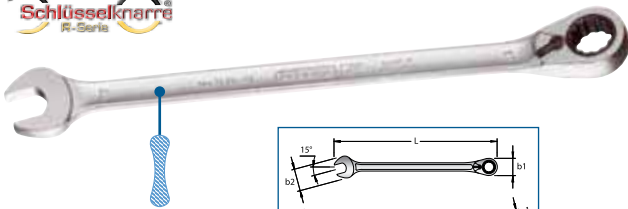

mm

Lieferensatz ab Sommer 2011

Code	No.	mm	°	L	a ₁	a ₂	b ₁	b ₂	91	1
2302225	7 UR XL 13	13	7	240	12.0	6.0	26.5	30.6	91	1
2302233	7 UR XL 14	14	7	253	12.5	6.5	29.1	32.7	91	1
2302268	7 UR XL 15	15	7	265	13.0	7.0	30.5	34.8	91	1
2302276	7 UR XL 16	16	6	282	13.6	7.5	32.8	35.9	91	1
2302284	7 UR XL 17	17	6	300	14.1	8.5	34.7	39.0	91	1
2302349	7 UR XL 18	18	6	315	14.6	9.0	35.8	41.1	91	1
2302357	7 UR XL 19	19	6	333	15.6	9.5	37.5	43.2	91	1
2302365	7 UR XL 21	21	6	353	16.6	10.0	41.4	46.8	91	1
2302373	7 UR XL 22	22	6	388	17.7	11.0	43.6	49.4	91	1
2302381	7 UR XL 24	24	6	432	19.7	12.0	49.2	54.0	91	1

Deviant packing units see article description.

www.gedore.com

7 UR XS

COMBINATION RATCHET SPANNER extra short

- With same size each end
- UD profile
- Ring 13° offset from shaft
- Especially suitable for work in confined spaces
- Working angle: 7° from 8 to 15 mm and 6° from 16 to 19 mm
- For ratchet loosening and fast tightening, with lever change
- Compact design 33% shorter than standard spanners, for confined spaced
- Small but not too small for large hands
- High torque transfer
- Hollow profile comfortable to hold
- Warp-resistant geometry with double T-girder effect
- GEDORE vanadium steel 31CrV3
- Non-glare look thanks to matte chrome-plating, locking insert and pawl manganese-phosphated
- Hot-forged
- Jaw exactly ground to spanner size
- Tried-and-tested GEDORE technology combined anew: spanner jaws of classic No. 6, stable hollow shaft of No. 7 and refined mechanism of the U-20 ratchets

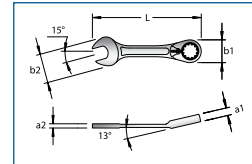

mm

Available as of summer 2011

Code	No.	mm	°	L	a ₁	a ₂	b ₁	b ₂	91	1
2304562	7 UR XS 8	8	7	94	7.0	3.8	17.5	18.5	91	1
2304570	7 UR XS 9	9	7	99	7.3	4.0	19.3	19.8	91	1
2304589	7 UR XS 10	10	7	104	7.7	4.2	21.0	21.5	91	1
2304597	7 UR XS 11	11	7	110	8.1	4.5	22.5	23.0	91	1
2304600	7 UR XS 12	12	7	117	8.6	4.8	23.6	26.0	91	1
2304635	7 UR XS 13	13	7	123	9.0	5.0	25.7	27.5	91	1
2304643	7 UR XS 14	14	7	129	9.4	5.2	28.2	30.0	91	1
2304651	7 UR XS 15	15	7	136	9.8	5.5	29.5	31.8	91	1
2304686	7 UR XS 16	16	6	144	10.2	5.8	31.7	34.0	91	1
2304694	7 UR XS 17	17	6	152	10.6	6.0	33.6	35.0	91	1
2304724	7 UR XS 18	18	6	160	11.0	6.2	34.6	38.0	91	1
2304732	7 UR XS 19	19	6	169	11.7	6.5	36.3	40.0	91	1

7 RA - 7 RB

ADAPTOR FOR 7 R / 7 UR

- The adapter transforms the ring ratchet spanner into a 1/4" or 5/16" bit ratchet
- Push-button release
- Wear-resistant and manganese phosphated push-button
- Fast-turning ring for swift release or tightening
- Secure adapter fit in the ring ratchet thanks to circlip
- Chrome-plated body



Code	No.	mm	mm	mm	mm	mm	91	1
2320495	7 RA-6,3	1/4	6.3			10		1
2320487	7 RA-10	3/8	10.0			13		1
2320479	7 RA-12,5	1/2	12.5			19		1
2329239	7 RB-6,3			1/4	6.3	10	11	1
2327643	7 RB-8			5/16	8.0	10	15	1



OPEN ENDED SPANNERS

6 "Strong and accurate"

- ▶ Carefully forged and professionally machined:
- ▶ Powerful jaws: ground precisely to exact nominal size for optimum contact areas
- ▶ High bending strength - does not fracture or splinter when overloaded, thus minimising the risk of injury
- ▶ Overloading indicated by deformation
- ▶ Secure grip thanks to slim profile shaft
- ▶ Non-glare matt chrome-plated finish
- ▶ Top-grade industrial quality for the hardest of continuous use

Spanner sizes:

- ▶ Metric dimensions: 4 x 4,5 - 55 x 60 mm
- ▶ Imperial dimensions: 1/4" x 5/16" - 2 1/4" x 2 7/16"
- ▶ Whitworth dimensions: 1/8 x 3/16 W - 7/8 x 1 W

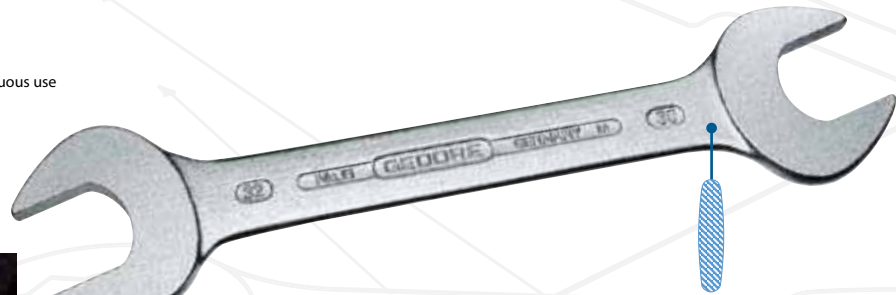

mm	"AF	Whitw.
4 x 4,5	1/4" x 5/16"	1/8" x 3/16"
55 x 60	2 1/4" x 2 7/16"	7/8" x 1"

6

DOUBLE OPEN ENDED SPANNER

- ▶ Acc. to DIN 3110, ISO 3318, ISO 1085, ISO 10102
- ▶ Slim pattern, oval shaft
- ▶ GEDORE vanadium steel 31CrV3, heads finely polished, chrome-plated
- ▶ * not standardised

mm

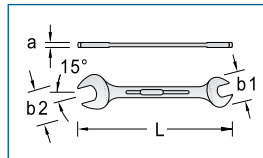

Code	No.	*	W	O mm	L	a	b ₁	b ₂	W	W
6063400	6 4x4,5	*		4 x 4,5	100	3.4	13.0	14.0	14	10
6063590	6 4x5	*		4 x 5	100	3.4	13.0	14.0	13	10
6063670	6 5x5,5	*		5 x 5,5	100	3.4	14.5	16.0	16	10
6063750	6 5,5x7	*		5,5 x 7	122	3.5	16.0	17.5	23	10
6063830	6 6x7	*		6 x 7	122	3.5	16.5	17.5	22	10
6063910	6 6x8	*		6 x 8	122	3.5	16.5	20.0	25	10
6064050	6 7x8	*		7 x 8	140	3.8	17.5	20.0	34	10
6064130	6 7x9	*		7 x 9	140	3.8	17.5	22.0	35	10
6064210	6 8x9	*		8 x 9	140	3.8	20.0	22.0	35	10
6064480	6 8x10	*		8 x 10	140	4.0	20.0	23.5	36	10
6064560	6 9x10	*		9 x 10	157	4.5	22.0	23.5	46	10
6064640	6 9x11	*		9 x 11	157	4.5	22.0	26.5	50	10
6064720	6 10x11	*		10 x 11	157	4.5	23.5	26.5	50	10
6064800	6 10x12	*		10 x 12	157	4.5	23.5	28.0	51	10
6064990	6 10x13	*		10 x 13	172	5.0	23.5	30.5	65	10
6065020	6 10x14	*		10 x 14	172	5.0	23.5	32.0	67	10
6065100	6 11x13	*		11 x 13	172	5.0	26.5	30.5	68	10
6065290	6 11x14	*		11 x 14	172	5.0	26.5	32.0	72	10
6065370	6 12x13	*		12 x 13	172	5.0	28.0	30.5	69	10
6065450	6 12x14	*		12 x 14	172	5.0	28.0	32.0	76	10
6065530	6 13x14	*		13 x 14	178	5.0	30.5	32.0	81	10
6065610	6 13x15	*		13 x 15	188	5.5	30.5	34.5	98	10
6068980	6 13x16	*		13 x 16	190	5.5	30.5	35.5	98	10
6065880	6 14x15	*		14 x 15	188	5.5	32.0	34.5	95	10
6065960	6 13x17	*		13 x 17	205	6.0	30.5	38.5	122	10
6066180	6 14x17	*		14 x 17	205	6.0	32.0	38.5	119	10
6066260	6 16x17	*		16 x 17	205	6.0	35.5	38.5	128	10
6066340	6 16x18	*		16 x 18	205	6.0	35.5	40.5	129	10

Code	No.	*	W	O mm	L	a	b ₁	b ₂	W	W
6066420	6 17x19	*		17 x 19	222	6.5	38.5	43.0	168	10
6066500	6 18x19	*		18 x 19	222	6.5	40.5	43.0	174	10
6069360	6 18x21	*		18 x 21	236	7.0	40.5	46.0	196	10
6066690	6 17x22	*		17 x 22	236	7.0	38.5	48.5	205	10
6066770	6 19x22	*		19 x 22	236	7.0	43.0	48.5	219	10
6066850	6 20x22	*		20 x 22	236	7.0	44.5	48.5	213	10
6066930	6 19x24	*		19 x 24	250	7.5	43.0	53.5	256	10
6067070	6 21x23	*		21 x 23	247	7.5	46.0	50.0	245	10
6069440	6 21x24	*		21 x 24	250	7.5	46.0	53.5	268	10
6067150	6 22x24	*		22 x 24	250	7.5	48.5	53.5	260	10
6067230	6 22x27	*		22 x 27	266	8.0	48.5	60.0	336	10
6067310	6 24x26	*		24 x 26	266	8.0	53.5	56.5	321	10
6067580	6 24x27	*		24 x 27	266	8.0	53.5	60.0	337	10
6067660	6 24x30	*		24 x 30	280	8.5	53.5	63.5	390	10
6067740	6 25x28	*		25 x 28	280	8.5	55.0	60.0	378	10
6067820	6 27x29	*		27 x 29	302	9.0	60.0	63.5	456	10
6067900	6 27x30	*		27 x 30	302	9.0	60.0	63.5	466	10
6068040	6 27x32	*		27 x 32	302	9.0	60.0	68.0	487	10
6068120	6 30x32	*		30 x 32	302	9.0	63.5	68.0	504	10
6069520	6 30x34	*		30 x 34	302	9.0	63.5	72.0	503	10
6068200	6 30x36	*		30 x 36	328	9.4	63.5	76.0	677	1
6068390	6 32x36	*		32 x 36	328	9.4	68.0	76.0	594	1
6069600	6 34x36	*		34 x 36	328	9.4	71.0	75.0	624	1
6068470	6 36x41	*		36 x 41	360	10.0	76.0	84.5	770	1
6068550	6 38x42	*		38 x 42	360	10.0	77.0	86.0	784	1
6068630	6 41x46	*		41 x 46	400	10.7	86.5	95.5	1104	1
6068710	6 46x50	*		46 x 50	450	11.6	95.5	102.0	1445	1
2312107	6 55x60	*	W	55 x 60	560	18.0	113.0	123.0	3160	1

**6****"AF"**

Code	No.	⊖	⊖ ^{AF}	L	a	b ₁	b ₂	↕	📦
6070020	6 1/4x5/16AF		1/4 x 5/16	122	3.7	17.5	20.0	24	1
6070100	6 5/16x3/8AF		5/16 x 3/8	140	4.0	20.0	23.5	35	1
6060060	6 5/16x11/32AF		5/16 x 11/32	140	4.0	20.5	22.5	34	1
6070290	6 3/8x7/16AF		3/8 x 7/16	157	4.5	23.5	26.5	47	1
6070370	6 7/16x1/2AF		7/16 x 1/2	172	5.0	26.5	30.0	65	1
6070450	6 1/2x9/16AF		1/2 x 9/16	190	5.5	30.0	33.0	91	1
6070530	6 9/16x5/8AF		9/16 x 5/8	190	5.5	33.0	36.0	92	1
6070610	6 19/32x11/16AF		19/32 x 11/16	205	6.0	34.5	39.5	130	1
6070880	6 5/8x11/16AF		5/8 x 11/16	205	6.0	36.0	39.5	124	1
6070960	6 5/8x3/4AF		5/8 x 3/4	222	6.5	36.0	42.5	152	1
6071180	6 11/16x3/4AF		11/16 x 3/4	222	6.5	39.5	42.5	165	1
6071260	6 3/4x25/32AF		3/4 x 25/32	222	6.5	42.5	43.5	189	1
6071340	6 3/4x7/8AF		3/4 x 7/8	236	7.0	42.5	48.5	216	1
6071420	6 25/32x13/16AF		25/32 x 13/16	236	7.0	44.5	46.0	206	1
6071500	6 13/16x7/8AF		13/16 x 7/8	236	7.0	46.0	48.5	232	1

Code	No.	⊖	⊖ ^{AF}	L	a	b ₁	b ₂	↕	📦
6071690	6 7/8x15/16AF		7/8 x 15/16	250	7.5	48.5	52.0	268	1
6073550	6 7/8x1.1/16AF		7/8 x 1.1/16	266	8.0	48.5	60.0	323	1
6071770	6 15/16x1AF		15/16 x 1	266	8.0	52.0	55.0	317	1
6071850	6 15/16x1.1/8AF		15/16 x 1.1/8	280	8.5	56.0	63.5	384	1
6071930	6 1x1.1/8AF		1 x 1.1/8	280	8.5	55.0	63.5	395	1
6072070	6 1.1/16x1.1/8AF		1.1/16 x 1.1/8	302	9.0	60.0	64.5	453	1
6072150	6 1.1/16x1.1/4AF		1.1/16 x 1.1/4	302	9.0	60.0	68.0	520	1
6072230	6 1.1/8x1.5/16AF		1.1/8 x 1.5/16	302	9.0	65.5	70.5	537	1
6072310	6 1.3/16x1.5/16AF		1.3/16 x 1.5/16	302	9.0	65.5	70.5	521	1
6072580	6 1.1/4x1.3/8AF		1.1/4 x 1.3/8	328	9.4	69.5	75.5	604	1
6072660	6 1.1/4x1.7/16AF		1.1/4 x 1.7/16	328	9.4	69.5	75.5	628	1
6072740	6 1.5/16x1.1/2AF		1.5/16 x 1.1/2	328	9.4	74.0	79.0	656	1
6072820	6 1.3/8x1.1/2AF		1.3/8 x 1.1/2	328	9.4	74.0	79.0	655	1
2317788	6 2.3/16x2.3/8AF	⊖	2.3/16 x 2.3/8	560	18.0	113.0	123.0	3160	1
2317761	6 2.1/4x2.7/16AF	⊖	2.1/4 x 2.7/16	560	18.0	113.0	123.0	3160	1



Code	No.	⊖ ^{WHV}	L	a	b ₁	b ₂	↕	📦	
6074440	6 1/8x3/16W		1/8 x 3/16	157	4.5	21.0	27.0	51	1
6074520	6 3/16x1/4W		3/16 x 1/4	172	5.0	27.0	31.0	73	1
6074600	6 1/4x5/16W		1/4 x 5/16	190	5.5	31.0	35.0	97	1
6074790	6 5/16x3/8W		5/16 x 3/8	205	6.0	35.0	40.5	125	1
6074870	6 3/8x7/16W		3/8 x 7/16	236	7.0	40.5	46.0	185	1
6074950	6 7/16x1/2W		7/16 x 1/2	250	7.5	46.0	51.0	254	1
6075090	6 1/2x9/16W		1/2 x 9/16	266	8.0	51.0	55.5	304	1

Whitw.

Code	No.	⊖ ^{WHV}	L	a	b ₁	b ₂	↕	📦	
6075250	6 9/16x5/8W		9/16 x 5/8	280	8.5	56.0	63.5	387	1
6075330	6 9/16x11/16W		9/16 x 11/16	280	8.5	56.0	63.5	391	1
6075410	6 5/8x3/4W		5/8 x 3/4	302	9.0	65.5	70.5	523	1
6075680	6 11/16x3/4W		11/16 x 3/4	302	9.0	65.5	70.5	548	1
6075840	6 3/4x7/8W		3/4 x 7/8	328	9.4	74.0	79.0	653	1
6075920	6 7/8x1.W		7/8 x 1	360	10.0	77.0	86.0	783	1

6**DOUBLE OPEN ENDED SPANNER SET**

- ▶ Sets of the most used sizes
- ▶ Acc. to DIN 3110, ISO 3318, ISO 1085, ISO 10102
- ▶ Slim pattern, oval shaft
- ▶ GEDORE vanadium steel 31CrV3, chrome-plated
- ▶ H = set in robust plastic holder
- ▶ WHV = set in tool holder

mm

Code	No.	Contents	↕	📦
6076810	6-6	6x7 8x9 10x11 12x13 14x15 16x17	415	1
6077380	6-8	6x7 8x9 10x11 12x13 14x15 16x17 18x19 20x22	819	1
2190796	6-09	5x5,5 6x7 8x9 10x11 12x13 14x15 16x17 18x19 20x22	840	1
6077540	6-10	6x7 8x9 10x11 12x13 14x15 16x17 18x19 20x22 21x23 24x27	1412	1
6077620	6-100	6x7 8x9 10x11 12x13 14x15 16x17 18x19 20x22 24x27 30x32	1660	1
6077700	6-12	6x7 8x9 10x11 12x13 14x15 16x17 18x19 20x22 21x23 24x26 25x28 27x32	2500	1
6077890	6-120	6x7 8x9 10x11 12x13 14x15 16x17 18x19 20x22 21x23 24x27 25x28 30x32	2350	1
6078350	6-122 ISO	6x7 8x9 10x11 12x13 14x15 16x18 17x19 20x22 21x23 24x26 27x32 30x34	2383	1
6079400	H 6-8	6x7 8x9 10x11 12x13 14x15 16x17 18x19 20x22	995	1
1754688	WHV 6-8	6x7 8x9 10x11 12x13 14x15 16x17 18x19 20x22	980	1
6079670	H 6-12	6x7 8x9 10x11 12x13 14x15 16x17 18x19 20x22 21x23 24x26 25x28 27x32	2545	1
6079750	H 6-120	6x7 8x9 10x11 12x13 14x15 16x17 18x19 20x22 21x23 24x27 25x28 30x32	2645	1

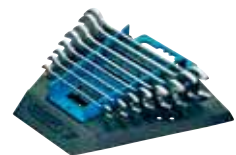
**"AF"**

Code	No.	Contents	↕	📦
6078000	6-600 A	3/8x7/16 1/2x9/16 5/8x11/16 3/4x25/32 13/16x7/8 15/16x1"	1073	1
6078270	6-8 A	1/4x5/16 5/16x3/8 7/16x1/2 9/16x5/8 19/32x11/16 3/4x25/32 13/16x7/8 15/16x1"	1174	1
6078510	6-12 A	1/4x5/16 5/16x3/8 3/8x7/16 7/16x1/2 1/2x9/16 9/16x5/8 19/32x11/16 5/8x3/4 3/4x7/8 25/32x13/16 15/16x1 1.1/16x1.1/8"	1952	1

Optional accessories

1500 ES / CT



85 - 93

636



141

637



141



8 "Small"

- Carefully forged and professionally machined:
- Flat heads: ground precisely to exact nominal size for optimum contact areas
- High bending strength - does not fracture or splinter when overloaded, thus minimising the risk of injury
- Overloading indicated by deformation
- Secure grip thanks to slim profile shaft
- Non-glare matt chrome-plated finish
- Offset head for difficult applications
- Top-grade industrial quality for the hardest of continuous use

Spanner sizes:

- Metric dimensions: 4 - 14 mm
- Imperial dimensions: 5/32" - 7/16"



mm	"AF
4 - 14	5/32" x 7/16"



8

DOUBLE ENDED MIDGET SPANNER small

- With same size each end
- Rings 15° and 75° offset from shaft
- GEDORE vanadium steel 31CrV3, heads finely polished, chrome-plated

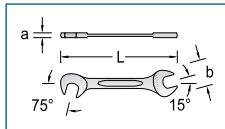

mm

Code	No.	mm	L	a	b		
6093900	8 4	4.0	69.0	2.2	10.4	5	10
6094040	8 4,5	4.5	69.0	2.2	10.4	6	10
6094120	8 5	5.0	77.3	2.2	12.4	6	10
6094200	8 5,5	5.5	77.3	2.2	12.4	7	10
6094390	8 6	6.0	77.3	2.2	12.4	8	10
6094470	8 7	7.0	89.5	2.6	14.8	11	10
6094550	8 8	8.0	95.5	3.1	17.5	16	10
6094630	8 9	9.0	103.8	3.1	20.2	20	10
6094710	8 10	10.0	103.8	3.1	20.2	21	10
6094980	8 11	11.0	115.2	3.1	24.0	28	10
6095010	8 12	12.0	115.2	3.1	24.0	28	10
6095280	8 13	13.0	130.5	3.1	28.0	37	10
6095360	8 14	14.0	130.5	3.1	28.0	38	10

"AF

Code	No.	"AF	L	a	b		
6096170	8 5/32AF	5/32	69.0	2.2	10.4	7	1
1965190	8 3/16AF	3/16	69.0	2.2	10.4	5	1
1965204	8 7/32AF	7/32	77.3	2.2	12.4	6	1
1965212	8 1/4AF	1/4	77.3	2.2	12.4	8	1
1965220	8 9/32AF	9/32	89.5	2.6	14.8	12	1
1965239	8 5/16AF	5/16	95.5	3.1	17.5	13	1
1965247	8 11/32AF	11/32	103.8	3.1	20.2	15	1
6096920	8 3/8AF	3/8	103.8	3.1	20.2	16	1
1965255	8 7/16AF	7/16	115.2	3.1	24.0	20	1

8-0100

DOUBLE ENDED MIDGET SPANNER SET 10 pieces

- With same size each end
- Rings 15° and 75° offset from shaft
- GEDORE vanadium steel 31CrV3, chrome-plated
- In blue plastic wallet



Code	No.	Contents		
6099000	8-0100	5 5,5 6 7 8 9 10 11 12 13	225	1

8-011

DOUBLE ENDED MIDGET SPANNER SET 11 pieces

- With same size each end
- Rings 15° and 75° offset from shaft
- GEDORE vanadium steel 31CrV3, chrome-plated
- In plastic case
- With "Check-Tool-System": 2-colour plastic insert to check that the set is complete



Code	No.	Contents		
1879146	8-011	4,5 5 5,5 6 7 8 9 10 11 12 13	280	1

625

SPANNER SET 11 pieces

- Sheet steel, hardened, bright nickel finish
- Contents: 8 open ended spanners, 1 contact file, 1 screwdriver, 1 feeler gauge 0.40 mm



Code	No.	Contents		
6524820	625 M	4 4,5 5 5,5 6 6,5 7 7,5	47	1
6524900	625 A	3/16 7/32 1/4 9/32 5/16 11/32 3/8 7/16"	53	1



60 CP

ADJUSTABLE SPANNER open end, chrome-plated

- Acc. to DIN 3117 Form A
- Jaw set at 15°
- Swedish pattern, roller with left hand thread
- With scale
- GEDORE vanadium steel 31CrV3, chrome-plated, polished heads

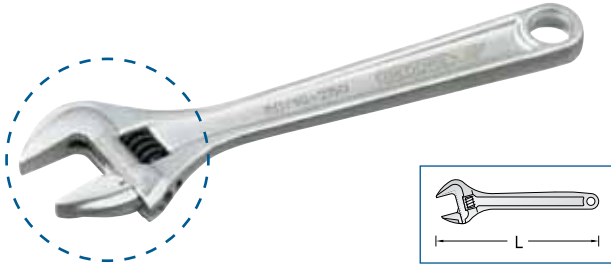

Code	No.	Size"	L	mm	"inch	Adjustment	Weight	Icon
6380990	60 CP 6	6	155	20	25/32	0-20	145	1
6381020	60 CP 8	8	205	25	1	0-25	270	1
6381100	60 CP 10	10	255	30	1.3/16	0-30	420	1
6381290	60 CP 12	12	305	36	1.7/16	0-36	785	1

E-60

SPARE PARTS FOR 60 CP / 60 P

- A = Jaw, BCD = Pin + Spring + Knurl

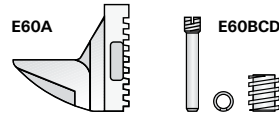

Code	No.	Weight	Icon
5360830	E-60 CP-A 6	20	1
5360910	E-60 CP-A 8	35	1
5361050	E-60 CP-A 10	55	1
5361130	E-60 CP-A 12	90	1
5360080	E-60 P-A 6	20	1
5360160	E-60 P-A 8	34	1
5360240	E-60 P-A 10	58	1
5360320	E-60 P-A 12	210	1
5360400	E-60 BCD 6	8	1
5360590	E-60 BCD 8	12	1
5360670	E-60 BCD 10	20	1
5360750	E-60 BCD 12	28	1

60 P - 62 P

ADJUSTABLE SPANNER open end, phosphated

- Sizes 6" - 18" = DIN 3117 Form A, jaw set at 15°
- Size 24" = DIN 3117 Form B, jaw set at 22,5°
- Swedish pattern, roller with left hand thread
- No. 60 P with scale
- Sizes 6" - 12" made from GEDORE vanadium steel 31CrV3
- Sizes 15" - 24" made from heat-treated steel EN 10083
- Phosphate finish, polished heads

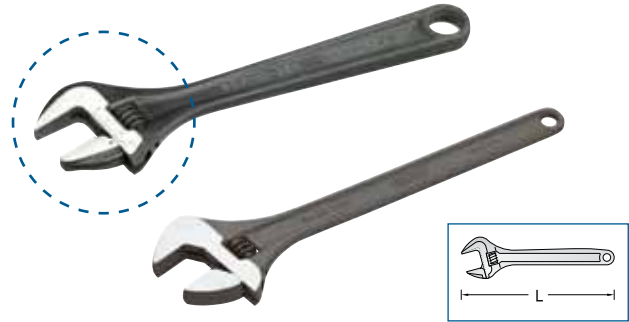

Code	No.	Size"	L	mm	"inch	Adjustment	Weight	Icon
6380560	60 P 6	6	155	20	25/32	0-20	145	1
6380640	60 P 8	8	205	25	1	0-25	295	1
6380720	60 P 10	10	255	30	1.3/16	0-30	430	1
6380800	60 P 12	12	305	36	1.7/16	0-36	705	1
6368430	62 P 15	15	380	43	1.11/16	0-45	1060	1
6368510	62 P 18	18	455	53	2.1/16	0-55	1715	1
6360880	62 P 24	24	610	63	2.1/2	0-64	3555	1

E-62

SPARE PARTS FOR 62 P

- A = Jaw, BCD = Pin + Spring + Knurl

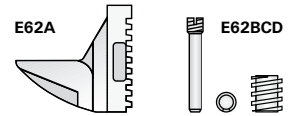

Code	No.	Weight	Icon
5368490	E-62 P-A 15	170	1
5368570	E-62 P-A 18	286	1
5374460	E-62 P-A 24	390	1
5367680	E-62 BCD 15	38	1
5367760	E-62 BCD 18	52	1
5374540	E-62 BCD 24	170	1

60 S

ADJUSTABLE WRENCH open end

- Acc. to DIN 3117 Form A, jaw set at 15°
- Swedish pattern, roller with left-hand thread
- With scale
- The protected mechanism and additional striking face allow light blows to be applied without impairing the function of the wrench
- Comfort grip from the GEDORE Design Studio
- Grip recess ensures secure hold - even with greasy hands
- Plastic handle (versions JC and JP) for fatigue-free working
- Hanging hole
- Version C nickel and chrome plated, head ground
- Version P manganese phosphated, head ground
- Version JP and JC complete with plastic handle



Code	No.	Size"	L (mm)	mm	Adjustment	Weight	Icon
1966294	60 S-8 P	8	206.5	23	0-25	340	1
1966308	60 S-8 JP	8	206.5	23	0-25	360	1
1966316	60 S-8 C	8	206.5	23	0-25	340	1
1966324	60 S-8 JC	8	206.5	23	0-25	360	1



894 "Black spanners"

- ▣ Carefully forged and professionally machined:
- ▣ Jaw: ground precisely to exact nominal size for optimum contact areas
- ▣ Extra-long shaft for deep applications
- ▣ High bending strength - does not fracture or splinter when overloaded, thus minimising the risk of injury
- ▣ Overloading indicated by deformation
- ▣ Secure grip thanks to profile shaft - very ergonomic and handy
- ▣ Manganese-phosphated or steel grey

Spanner sizes:

- ▣ Metric dimensions: 6 - 135 mm
- ▣ Imperial dimensions: 1/4" - 3 7/8"

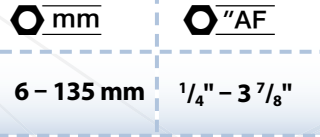

894

SINGLE OPEN ENDED SPANNER

- ▣ Acc. to DIN 894, ISO 3318
- ▣ Jaw set at 15°
- ▣ GEDORE vanadium steel 31CrV3
- ▣ Manganese-phosphate finish up to 38 mm, shotblast finish from 41 mm and larger
- ▣ Sizes 10 - 135 mm with hanging hole
- ▣ * not standardised

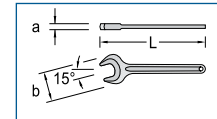

Code	No.	*	W	Ø mm	L	a	b	↕	⊞
6573600	894 6			6	73	3.2	15.5	10	10
6573790	894 7			7	78	3.2	17.0	10	10
6573870	894 8			8	94	3.5	19.0	15	10
6573950	894 9			9	100	4.0	20.0	17	10
6574090	894 10			10	106	4.5	22.0	22	10
6574170	894 11			11	112	5.0	24.5	29	10
6574250	894 12			12	124	5.0	26.5	35	10
6574330	894 13			13	132	5.5	28.5	39	10
6574410	894 14			14	140	5.5	30.0	44	10
6574680	894 15			15	145	5.5	32.0	46	10
6574760	894 16			16	155	5.5	33.0	56	10
6574840	894 17			17	159	6.0	36.0	60	10
6575220	894 18			18	165	6.2	38.0	67	10
6575060	894 19			19	170	7.0	40.0	81	10
5536380	894 20	*	W	20					1
5271140	894 21		W	21					1
6575300	894 22			22	193	8.0	46.0	113	10
5332890	894 23	*	W	23					1
6575570	894 24			24	217	9.0	50.0	154	10
6575650	894 25	*		25	217	9.0	52.0	142	10
5326650	894 26	*	W	26					1
6575810	894 27			27	239	9.8	56.0	199	10
1391151	894 28	*	W	28					1
5495090	894 29	*	W	29					1
6576380	894 30			30	263	10.8	62.0	249	10
6576540	894 32			32	275	11.8	66.0	374	10
1478273	894 33	*	W	33					1
6575730	894 34			34	290	12.3	70.0	365	1
5444340	894 35	*	W	35					1
6576700	894 36			36	305	12.8	74.0	392	1
1421573	894 37	*	W	37					1
6576890	894 38	*		38	305	12.8	74.0	406	1
5444420	894 39	*	W	39					1
1443046	894 40	*	W	40					1
6576970	894 41			41	344	13.8	84.0	568	1
1334948	894 42	*	W	42					1
1478281	894 43	*	W	43					1
5330090	894 44	*	W	44					1
1449362	894 45	*	W	45					1
6577000	894 46			46	380	14.8	94.0	704	1
1478311	894 47	*	W	47					1
5315530	894 48	*	W	48					1
1478338	894 49	*	W	49					1

Code	No.	*	W	Ø mm	L	a	b	↕	⊞
6577190	894 50			50	413	15.8	102.0	956	1
1478346	894 51	*	W	51					1
5322310	894 52	*	W	52	412	17.0	102.0	950	1
1478192	894 53	*	W	53					1
5339470	894 54	*	W	54	457	18.0	112.0	1300	1
6577270	894 55			55	459	16.8	112.0	1125	1
1381210	894 56	*	W	56					1
1478354	894 57	*	W	57					1
5147130	894 58	*	W	58	457	18.0	112.0	1300	1
2315122	894 59	*	W	59	492	18.0	112.0	1600	1
6577350	894 60			60	494	17.7	122.0	1439	1
1648187	894 62	*	W	62					1
1478370	894 63	*	W	63	492	18.0	122.0	492	1
2315157	894 64	*	W	64	528	19.0	132.0	1800	1
6577430	894 65			65	528	18.7	132.0	1686	1
2315173	894 67	*	W	67	528	19.0	132.0	1800	1
6577510	894 70			70	572	19.7	142.0	2111	1
1879758	894 71	*	W	71	572	20.0	142.0	2200	1
1478419	894 72	*	W	72					1
1486551	894 74	*	W	74	608	21.0	152.0	2700	1
6577780	894 75			75	610	20.7	152.0	2782	1
1478435	894 77	*	W	77	608	21.0	152.0	2700	1
2315181	894 79	*	W	79	645	21.0	162.0	3000	1
6577860	894 80			80	645	21.7	162.0	2905	1
2151103	894 82	*	W	82	645	22.0	162.0	3000	1
6577940	894 85			85	690	23.0	173.0	3895	1
2315211	894 88	*	W	88	690	23.0	173.0	4000	1
6578080	894 90	*		90	690	23.0	173.0	3720	1
2315270	894 94	*	W	94	847	25.0	195.0	6100	1
6578160	894 95	*		95	847	25.0	195.0	6335	1
2315297	894 96	*	W	96	847	25.0	195.0	6100	1
2315300	894 97	*	W	97	847	25.0	195.0	6100	1
6578240	894 100	*		100	847	25.0	195.0	6125	1
6578320	894 105	*		105	1000	28.0	217.0	8905	1
6578400	894 110	*		110	1000	28.0	217.0	8650	1
6578590	894 115	*		115	1000	28.0	220.0	8480	1
6578670	894 120	*		120	1000	28.0	220.0	8260	1
6576030	894 125	*		125	1000	28.0	225.0	8345	1
6576110	894 130	*		130	1000	27.0	225.0	8230	1
6576460	894 135	*		135	1000	27.0	225.0	7775	1

**894****SINGLE OPEN ENDED SPANNER**

- ▶ Jaw set at 15°
- ▶ GEDORE vanadium steel 31CrV3
- ▶ Manganese-phosphated
- ▶ Sizes 7/16" - 1.1/8" with hanging hole

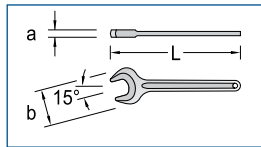

Code	No.	W	AF	L	a	b	↕	⊞
6579210	894 1/4AF		1/4	73	3.2	15.5	9	10
6579560	894 5/16AF		5/16	94	3.5	19.0	13	1
6579720	894 3/8AF		3/8	100	4.0	20.0	14	1
1425161	894 13/32AF	W	13/32					1
6579990	894 7/16AF		7/16	112	5.0	24.5	26	1
6580060	894 1/2AF		1/2	132	5.5	26.5	40	5
1503227	894 19/32AF	W	19/32					1
6580140	894 9/16AF		9/16	140	5.5	30.0	47	1
6580300	894 5/8AF		5/8	155	5.5	33.0	53	1
6580490	894 11/16AF		11/16	165	6.2	38.0	64	1
6580570	894 3/4AF		3/4	170	7.0	40.0	74	1
6580730	894 13/16AF		13/16	170	7.0	40.0	74	1
6580810	894 7/8AF		7/8	193	8.0	46.0	106	1
6581030	894 15/16AF		15/16	217	9.0	50.0	147	1
6581110	894 1AF		1	217	9.0	52.0	156	1

Code	No.	W	AF	L	a	b	↕	⊞
6581380	894 1.1/16AF		1.1/16	239	10.0	56.0	186	1
6581460	894 1.1/8AF		1.1/8	239	10.0	56.0	205	1
1503219	894 1.3/16AF	W	1.3/16					1
1503197	894 1.1/4AF	W	1.1/4					1
1503189	894 1.5/16AF	W	1.5/16					1
1503170	894 1.3/8AF	W	1.3/8					1
1503162	894 1.7/16AF	W	1.7/16					1
1418653	894 1.1/2AF	W	1.1/2					1
1503154	894 1.9/16AF	W	1.9/16					1
1503138	894 1.5/8AF	W	1.5/8					1
1418645	894 1.11/16AF	W	1.11/16					1
1503111	894 1.3/4AF	W	1.3/4					1
1503081	894 1.13/16AF	W	1.13/16					1
1418637	894 1.7/8AF	W	1.7/8					1
1503103	894 1.15/16AF	W	1.15/16					1
5267460	894 2AF	W	2	412	17.0	102.0	950	1
2315327	894 2.1/16AF	W	2.1/16	412	17.0	102.0	950	1
2315378	894 2.3/16AF	W	2.3/16	457	18.0	112.0	1300	1
5265170	894 2.1/4AF	W	2.1/4	457	18.0	112.0	1300	1
2315440	894 2.5/16AF	W	2.5/16	457	18.0	112.0	1300	1
2315416	894 2.3/8AF	W	2.3/8	492	18.0	122.0	1600	1
2315343	894 2.1/2AF	W	2.1/2	492	18.0	122.0	1600	1
5377050	894 2.9/16AF	W	2.9/16	528	19.0	132.0	1800	1
1448854	894 2.5/8AF	W	2.5/8	528	19.0	132.0	1800	1
2315394	894 2.3/4AF	W	2.3/4	572	20.0	142.0	2200	1
2315491	894 2.7/8AF	W	2.7/8	608	21.0	152.0	2700	1
2315521	894 2.15/16AF	W	2.15/16					1
1777483	894 3AF	W	3	608	21.0	152.0	2700	1
1503456	894 3.1/8AF	W	3.1/8					1
2307138	894 3.1/2AF	W	3.1/2					1
2315548	894 3.7/8AF	W	3.7/8	847	25.0	195.0	6100	1

**VDE 894****504**





895 "Black double open ended spanners"

- ✔ Carefully forged and professionally machined:
- ✔ Jaws: ground precisely to exact nominal size for optimum contact areas
- ✔ Extra-long shaft for deep applications
- ✔ High bending strength - does not fracture or splinter when overloaded, thus minimising the risk of injury
- ✔ Overloading indicated by deformation
- ✔ Secure grip thanks to profile shaft - very ergonomic and handy
- ✔ Manganese-phosphated or steel grey

Spanner sizes:

- ✔ Metric dimensions: 6 x 7 - 75 x 80 mm
- ✔ Imperial dimensions: 1/4 x 5/16" - 2 5/8 x 2 13/16"



 mm	 "AF
6 x 7	1/4" x 5/16"
75 x 80	2 5/8" x 2 13/16"



DOUBLE ENDED RING SPANNERS

2 "Offset"

- Carefully forged and professionally machined:
- Ring: thin-walled, 5° deep offset from shaft, with UD profile for gentle transmission of force
- High bending strength - does not fracture or splinter when overloaded, thus minimising the risk of injury
- Overloading indicated by deformation
- Non-glare matt chrome-plated finish
- Specialist for extremely deep or inset nuts
- Top-grade industrial quality for the hardest of continuous use



Spanner sizes:

- Metric dimensions: 5.5 x 7 - 85 x 90 mm
- Imperial dimensions: 1/4 x 5/16" - 3 x 3 1/8"
- Whitworth dimensions: 1/8 x 3/16 W - 1 7/8 x 2 W



mm	"AF"	Whitw.
5.5 x 7	1/4" x 5/16"	1/8" x 3/16"
85 x 90	3" x 3 1/8"	1 7/8" x 2"

2

DOUBLE ENDED RING SPANNER

- Rings deep offset, strong but thin walls
- Acc. to DIN 838, ISO 3318, ISO 1085, ISO 10104
- GEDORE vanadium steel 31CrV3, chrome-plated, polished rings
- * not standardised

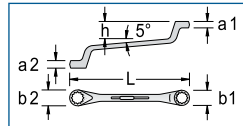

Code	No.	*	Ømm	L	a ₁	a ₂	b ₁	b ₂	h	↕	⊞
6010630	2 5,5x7	*	5,5 x 7	170	5,6	6,6	10,0	12,0	20,7	62	5
6015350	2 6x7		6 x 7	170	5,6	6,6	10,5	12,0	20,7	45	10
6015430	2 7x8		7 x 8	180	5,6	6,6	12,0	13,3	21,7	68	10
6015510	2 8x9		8 x 9	182	6,6	7,6	13,3	14,4	21,7	65	10
6015780	2 8x10		8 x 10	182	6,6	8,5	13,3	15,9	21,7	72	10
6015860	2 9x11	*	9 x 11	195	7,6	9,5	14,4	17,5	23,6	86	10
6015940	2 10x11		10 x 11	195	8,5	9,5	15,9	17,5	23,6	89	10
6016080	2 10x12	*	10 x 12	195	8,5	9,6	15,9	19,0	23,6	89	10
6016160	2 10x13		10 x 13	212	8,5	10,3	15,9	20,1	25,1	122	10
6016320	2 11x13		11 x 13	212	9,5	10,3	17,5	20,1	25,1	129	5
6016400	2 11x14	*	11 x 14	212	9,5	10,6	17,5	21,6	25,1	151	5
6016590	2 12x13		12 x 13	212	9,6	10,3	19,0	20,1	25,1	125	10
6016670	2 12x14		12 x 14	212	9,6	10,6	19,0	21,6	25,1	134	5
6016750	2 13x14		13 x 14	225	10,3	10,6	20,1	21,6	26,1	156	5
6016830	2 13x15		13 x 15	225	10,3	11,3	20,1	23,1	26,1	160	5
6016910	2 14x15		14 x 15	225	10,6	11,3	21,6	23,1	26,1	154	10
6025310	2 13x16		13 x 16	235	10,3	11,6	20,1	24,2	26,1	166	5
6017050	2 13x17		13 x 17	245	10,3	12,3	20,1	25,8	27,1	212	5
6017130	2 14x17		14 x 17	245	10,6	12,3	21,6	25,8	27,1	227	5
6017210	2 16x17		16 x 17	245	11,6	12,3	24,2	25,8	27,1	205	10
6025660	2 16x18		16 x 18	265	11,6	12,6	24,2	27,0	28,6	250	5
6017480	2 17x19		17 x 19	265	12,3	13,0	25,8	28,8	28,6	250	10
6017560	2 18x19		18 x 19	265	12,6	13,0	27,0	28,8	28,6	258	10
6025740	2 18x21		18 x 21	285	12,6	13,4	27,0	31,1	31,0	327	5
6017720	2 19x22		19 x 22	287	13,0	14,3	28,8	33,0	31,0	352	5
6017800	2 20x22	*	20 x 22	287	13,3	14,3	30,1	33,0	31,0	345	5

Code	No.	*	Ømm	L	a ₁	a ₂	b ₁	b ₂	h	↕	⊞
6017990	2 19x24		19 x 24	305	13,0	14,4	28,8	35,7	33,0	419	5
6018020	2 21x23	*	21 x 23	305	13,4	14,3	30,9	34,0	33,0	411	5
6025820	2 21x24		21 x 24	307	13,4	14,4	30,9	35,7	33,0	386	1
6018100	2 22x24		22 x 24	307	14,3	14,4	32,8	35,7	33,0	412	10
6018290	2 22x27	*	22 x 27	325	14,3	15,4	32,8	40,1	34,5	518	5
6018370	2 24x26	*	24 x 26	325	14,4	15,3	35,7	38,0	34,5	503	5
6018450	2 24x27		24 x 27	325	14,4	15,4	35,7	40,1	34,5	506	10
6018530	2 24x30		24 x 30	345	14,4	16,4	35,7	44,1	35,5	579	5
6018610	2 25x28	*	25 x 28	345	14,4	15,4	37,0	41,1	35,5	565	5
6018880	2 27x29	*	27 x 29	345	14,8	16,4	40,1	42,5	35,5	678	1
6018960	2 27x30		27 x 30	345	15,4	16,4	40,1	44,1	35,5	628	5
6019180	2 27x32		27 x 32	370	15,4	17,4	40,1	47,1	37,4	701	5
6019260	2 30x32		30 x 32	370	16,4	17,4	44,1	47,1	37,4	731	5
6025900	2 30x34		30 x 34	375	16,4	18,7	44,1	50,0	37,4	763	1
6019340	2 30x36		30 x 36	400	16,4	19,4	43,6	53,0	38,4	872	1
6019420	2 32x36		32 x 36	400	17,4	19,4	47,1	53,0	38,4	878	1
6026040	2 34x36		34 x 36	420	18,7	19,4	50,0	53,0	38,4	929	1
6019500	2 36x41		36 x 41	440	19,4	20,4	53,0	60,5	40,4	1166	1
6019690	2 38x42	*	38 x 42	440	19,7	20,4	56,4	62,5	40,4	1207	1
6019770	2 41x46		41 x 46	485	20,4	22,2	62,0	68,9	42,8	1535	1
6019850	2 46x50		46 x 50	535	22,2	23,6	68,9	75,5	47,8	2035	1
6019930	2 55x60	*	55 x 60	610	24,6	25,6	84,9	91,8	54,2	3125	1
6020000	2 65x70	*	65 x 70	685	26,6	27,6	101,4	107,4	58,1	4860	1
6020190	2 75x80	*	75 x 80	790	29,0	30,0	120,0	127,0	61,0	6685	1
6010980	2 85x90	*	85 x 90	800	29,0	30,0	120,0	127,0	61,0	6455	1

Optional accessories

➔ **1500 ES**

85 - 89

➔ **1500 CT**

90 - 93



2

Code	No.	W	O ^{AF}	L	a ₁	a ₂	b ₁	b ₂	h	±0.1	±0.2
6021400	2 1/4x5/16AF	1/4 x 5/16		170	6.0	7.2	11.0	13.2	20.7	63	1
6021590	2 5/16x3/8AF	5/16 x 3/8		180	7.2	8.2	13.2	15.2	21.7	73	1
6021670	2 3/8x7/16AF	3/8 x 7/16		195	8.2	9.5	15.2	17.5	23.6	98	1
6021750	2 7/16x1/2AF	7/16 x 1/2		212	9.5	10.0	17.5	20.0	25.1	134	1
6021830	2 1/2x9/16AF	1/2 x 9/16		225	10.0	10.6	20.0	22.1	26.1	141	1
6021910	2 9/16x5/8AF	9/16 x 5/8		225	10.6	11.6	22.1	24.2	26.1	156	1
6022050	2 19/32x11/16AF	19/32 x 11/16		245	11.3	12.3	22.9	26.5	27.1	195	1
6022130	2 5/8x11/16AF	5/8 x 11/16		245	11.6	12.3	24.2	26.5	27.1	210	1
6022210	2 5/8x3/4AF	5/8 x 3/4		265	11.6	13.0	24.2	29.0	28.6	258	1
6022480	2 11/16x3/4AF	11/16 x 3/4		265	12.3	13.0	26.5	29.0	28.6	271	1
6022560	2 3/4x25/32AF	3/4 x 25/32		265	13.0	13.3	29.0	30.0	28.6	256	1
6022640	2 3/4x7/8AF	3/4 x 7/8		285	13.0	14.3	29.0	33.3	31.0	290	1
6022720	2 25/32x13/16AF	25/32 x 13/16		285	13.3	13.6	30.0	31.0	31.0	373	1
6022800	2 13/16x7/8AF	13/16 x 7/8		285	13.6	14.3	31.0	33.3	31.0	372	1
6025580	2 7/8x1.1/16AF	7/8 x 1.1/16		325	14.3	15.8	33.3	40.1	34.5	490	1
6023020	2 15/16x1AF	15/16 x 1		325	14.8	15.0	35.7	37.5	34.5	462	1
6023100	2 1x1.1/8AF	1 x 1.1/8		345	15.0	16.3	37.5	42.2	35.5	591	1
6023290	2 1.1/16x1.1/8AF	1.1/16 x 1.1/8		345	14.8	16.4	40.0	42.5	35.5	675	1
6023370	2 1.1/16x1.1/4AF	1.1/16 x 1.1/4		370	15.8	17.7	40.1	47.1	37.4	696	1



Code	No.	W	O ^{mm}	L	a ₁	a ₂	b ₁	b ₂	h	±0.1	±0.2
6026550	2 1/8x3/16W	1/8 x 3/16		195	7.8	9.5	14.3	18.0	23.6	95	1
6026630	2 3/16x1/4W	3/16 x 1/4		212	9.5	10.3	18.0	20.9	25.1	132	1
6026710	2 1/4x5/16W	1/4 x 5/16		225	10.3	11.3	20.9	23.7	26.1	160	1
6026980	2 5/16x3/8W	5/16 x 3/8		245	11.3	12.6	23.7	27.0	27.1	198	1
6027280	2 3/8x7/16W	3/8 x 7/16		285	12.6	13.8	27.0	31.0	31.0	292	1
6027360	2 7/16x1/2W	7/16 x 1/2		305	13.8	14.6	31.0	34.8	33.0	404	1
6027440	2 1/2x9/16W	1/2 x 9/16		325	14.6	15.0	34.8	38.0	34.5	487	1
6027520	2 9/16x5/8W	9/16 x 5/8		345	15.0	16.3	38.0	41.0	35.5	586	1
6027600	2 9/16x11/16W	9/16 x 11/16		345	15.0	16.7	38.0	45.1	35.5	586	1
6027790	2 5/8x3/4W	5/8 x 3/4		370	16.3	18.2	41.4	48.5	37.4	702	1

2

DOUBLE ENDED RING SPANNER SET

- Sets of the most used sizes
- Rings deep offset, strong but thin walls, UD profile
- Acc. to DIN 838, ISO 3318, ISO 1085, ISO 10104
- GEDORE vanadium steel 31CrV3, chrome-plated, polished rings



Code	No.	Contents	±0.1	±0.2
6030580	2-8	6x7 8x9 10x11 12x13 14x15 16x17 18x19 20x22	1297	1
6030740	2-10	6x7 8x9 10x11 12x13 14x15 16x17 18x19 20x22 21x23 24x27	2225	1
6031120	2-100	6x7 8x9 10x11 12x13 14x15 16x17 18x19 20x22 24x27 30x32	2555	1
6030900	2-12	6x7 8x9 10x11 12x13 14x15 16x17 18x19 20x22 21x23 24x26 25x28 27x32	4060	1
6031040	2-120	6x7 8x9 10x11 12x13 14x15 16x17 18x19 20x22 21x23 24x27 25x28 30x32	4000	1
6031390	2-122 ISO	6x7 8x9 10x11 12x13 14x15 16x18 17x19 20x22 21x23 24x26 27x32 30x34	3730	1



Code	No.	Contents	±0.1	±0.2
6031470	2-8 A	1/4x5/16 5/16x3/8 7/16x1/2 9/16x5/8 19/32x11/16 3/4x25/32 13/16x7/8 15/16x1"	1855	1
6031630	2-10 A	1/4x5/16 5/16x3/8 7/16x1/2 9/16x5/8 19/32x11/16 3/4x25/32 13/16x7/8 15/16x1 1.1/16x1.1/4 1.1/8x1.5/16"	3340	1

2 B

DOUBLE ENDED RING SPANNER short pattern

- Shallow offset
- Thin walled, polished rings
- GEDORE vanadium steel 31CrV3, chrome-plated

Spanner sizes:

- Metric dimensions: 6 x 7 - 17 x 19 mm



Code	No.	O ^{mm}	L	a ₁	a ₂	b ₁	b ₂	h ₁	h ₂	±0.1	±0.2
6051150	2 B 6x7	6 x 7	115	5.5	6.5	10.5	12.0	6	7	23	5
6051230	2 B 8x9	8 x 9	120	6.5	7.5	12.5	13.5	8	9	29	5
6051310	2 B 10x11	10 x 11	125	6.5	7.5	15.0	17.0	8	9	37	5
6051580	2 B 12x13	12 x 13	135	8.5	9.5	18.5	20.0	10	11	56	5
6051660	2 B 14x15	14 x 15	145	9.5	10.5	21.0	22.0	11	12	75	5
6051740	2 B 17x19	17 x 19	155	10.5	11.5	25.0	28.0	15	17	105	5

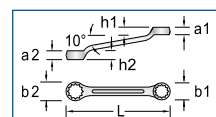



Universally "straight"

4

FLAT RING SPANNER straight pattern

- Acc. to DIN 837 Form B, ISO 3318, ISO 1085
- Flat pattern
- Thin walled
- UD-profile
- GEDORE vanadium steel 31CrV3, chrome-plated
- * not standardised



mm	"AF
6 x 7	1/4" x 5/16"
46 x 50	1/2" x 9/16"

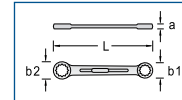

mm

Code	No.	*	mm	L	a	b ₁	b ₂	↻	☒
6052710	4 6x7		6 x 7	99	4.5	10.0	11.5	14	10
6053010	4 8x9		8 x 9	114	5.2	13.0	14.5	24	10
6053280	4 8x10		8 x 10	115	5.2	13.0	16.0	22	10
6053440	4 10x11		10 x 11	131	5.8	16.0	17.0	34	10
6053520	4 10x13		10 x 13	149	6.4	16.0	20.5	45	10
6053870	4 12x13		12 x 13	149	6.4	19.0	20.5	49	10
6054170	4 13x15		13 x 15	161	7.2	20.5	23.0	64	10
6054250	4 14x15		14 x 15	161	7.2	21.5	23.0	64	10
6054330	4 13x17		13 x 17	167	7.8	20.5	25.5	74	10
6054410	4 14x17		14 x 17	169	7.8	21.5	25.5	77	5
6054680	4 16x17		16 x 17	169	7.8	24.5	25.5	84	10
6054760	4 17x19		17 x 19	186	8.5	25.5	28.0	98	10
6054840	4 18x19		18 x 19	186	8.5	27.0	28.0	106	10
6054920	4 19x22		19 x 22	209	9.4	28.0	32.5	136	10
6055060	4 20x22	*	20 x 22	209	9.4	29.5	32.5	134	10
6055140	4 19x24	*	19 x 24	233	10.0	28.0	35.5	176	5
6055220	4 21x23	*	21 x 23	233	10.0	30.5	33.5	171	5
6055300	4 22x24		22 x 24	233	10.0	32.5	35.5	184	10
6055490	4 24x26	*	24 x 26	261	10.8	35.5	38.0	230	5
6055570	4 24x27		24 x 27	260	10.8	35.5	39.0	249	10
6055730	4 25x28	*	25 x 28	289	11.6	36.5	41.0	273	1
6055650	4 24x30		24 x 30	290	11.6	35.5	43.5	303	10

Code	No.	*	mm	L	a	b ₁	b ₂	↻	☒
6055810	4 27x32		27 x 32	320	12.6	39.0	46.0	373	5
6056030	4 30x32		30 x 32	320	12.6	43.5	46.0	399	5
6056110	4 30x36		30 x 36	357	13.8	43.5	51.5	469	1
6056380	4 32x36		32 x 36	357	13.8	46.0	51.5	492	1
6056460	4 36x41		36 x 41	391	15.0	51.5	59.0	616	1
6056540	4 41x46		41 x 46	431	16.2	59.0	66.0	789	1
6056620	4 46x50		46 x 50	473	16.5	66.0	71.5	1035	1

"AF

Code	No.		"AF	L	a	b ₁	b ₂	↻	☒
1965263	4 1/4x5/16AF		1/4 x 5/16	108	5.1	10.3	12.9	50	1
1965271	4 5/16x11/32AF		5/16 x 11/32	114	5.1	12.9	14.2	50	1
1965298	4 3/8x7/16AF		3/8 x 7/16	131	5.7	15.5	17.1	50	1
1965301	4 7/16x1/2AF		7/16 x 1/2	150	6.3	17.2	20.2	50	1
1965328	4 1/2x9/16AF		1/2 x 9/16	150	6.3	20.2	21.8	50	1

4

FLAT RING SPANNER SET

- Made up of sizes most in use
- Flat pattern
- Thin walled
- UD-profile
- Acc. to DIN 837 Form B, ISO 3318, ISO 1085
- GEDORE vanadium steel 31CrV3, chrome-plated



Code	No.	Contents	↻	☒
6061700	4-8	6x7 8x9 10x11 12x13 14x15 16x17 18x19 20x22	521	1
6062000	4-12	6x7 8x9 10x11 12x13 14x15 16x17 18x19 20x22 21x23 24x26 25x28 27x32	1549	1
6062190	4-120	6x7 8x9 10x11 12x13 14x15 16x17 18x19 20x22 21x23 24x27 25x28 30x32	2000	1

TX 4

FLAT RING SPANNER straight pattern, for protruding TORX® head screws

- GEDORE vanadium steel 31CrV3, chrome-plated, polished rings
- TORX® = reg. trademark of Acument Intellectual Properties, LLC. USA

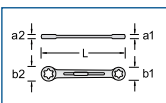

Code	No.	mm	mm	mm	L	a ₁	a ₂	b ₁	b ₂	↻	☒
6059800	TX 4 E6xE8	E6xE8	M5 - M7	5,74 x 7,52	110	5.0	6.0	9.0	11.0	14	5
6059990	TX 4 E10xE12	E10xE12M8 - M10		9,42 x 11,17	140	7.0	8.0	13.0	15.0	39	5
6060140	TX 4 E14xE18	E14xE18M12 - M14		12,9 x 16,7	180	8.5	9.5	17.0	21.0	74	5
6060220	TX 4 E20xE24	E20xE24M16 - M20		18,45 x 22,16	226	11.5	13.5	24.5	28.5	163	5

4 R

FLAT RING RATCHET SPANNER



"AF

Code	No.		"AF	L	a ₁	a ₂	b ₁	b ₂	↻	☒
1967908	4 R 1/4x5/16AF		1/4 x 5/16	115	6.3	6.5	14.2	17.2	20	1
1967924	4 R 5/16x11/32AF		5/16 x 11/32	128	6.5	6.9	16.8	20.2	20	1
1967916	4 R 3/8x7/16AF		3/8 x 7/16	150	7.3	7.7	20.2	21.8	60	1
1967894	4 R 1/2x9/16AF		1/2 x 9/16	180	8.6	9.0	24.8	26.5	20	1



"Special"

- For applications involving hydraulic/brake lines or breathing conduits on diving cylinders

Spanner sizes:

- Metric dimensions: 8 x 10 - 46 x 50 mm
- Imperial dimensions: 5/16 x 3/8" - 7/8 x 1"



mm	"AF"
8 x 10	5/16" x 3/8"
46 x 50	7/8" x 1"

"Special"

- Specialists in tight spaces

Spanner sizes:

- Metric dimensions: 11 x 13 - 19 x 22 mm
- Imperial dimensions: 7/16 x 1/2" - 3/4 x 7/8"

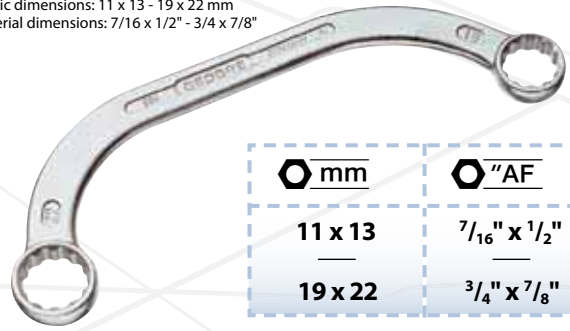

mm	"AF"
11 x 13	7/16" x 1/2"
19 x 22	3/4" x 7/8"



400

FLARE NUT SPANNER, OPEN

- Acc. to DIN 3118
- Ring 15° offset from shaft
- Hexagon gap 30° offset, UD-section at 15° offset
- Sizes 8x10 to 12x14 mm with hexagon
- GEDORE vanadium steel 31CrV3, chrome-plated
- * not standardised

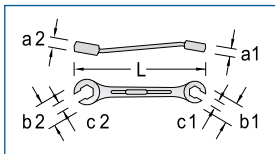

mm

Code	No.	*	U	mm	L	a ₁	a ₂	b ₁	b ₂	c ₁	c ₂	↕	☑
6057190	400 8x10	*		8 x 10	140	6.5	8.0	18	20	6.0	7.0	45	10
6056970	400 9x11	*		9 x 11	145	7.5	8.5	19	22	6.5	8.5	59	10
6057270	400 10x11			10 x 11	150	8.0	8.5	20	22	7.0	8.5	64	10
6051070	400 10x12	*		10 x 12	150	8.0	9.5	20	24	7.0	9.0	73	5
6057350	400 11x13			11 x 13	160	8.5	10.5	22	26	8.5	10.0	77	10
6057430	400 12x14			12 x 14	170	9.5	11.2	24	28	9.0	11.0	106	10
6057000	400 13x15	* U		13 x 15	180	10.5	11.8	26	29	10.0	12.0	116	10
6057510	400 14x17			14 x 17	195	11.5	12.2	28	32	11.0	14.0	136	10
6057780	400 17x19			17 x 19	210	12.2	13.2	32	35	14.0	15.0	179	10
6058670	400 19x22			19 x 22	230	13.2	15.2	35	41	15.0	17.0	246	10
6057860	400 22x24			22 x 24	250	15.2	16.2	41	45	17.0	18.0	335	10
6058750	400 24x27			24 x 27	270	16.2	17.2	45	48	18.0	20.0	408	10
6058830	400 30x32			30 x 32	300	20.2	22.2	50	52	22.0	24.0	575	5
1933175	400 36x41	*		36 x 41	351	25.2	28.2	59	67	25.0	32.0	980	1
2297183	400 46x50	* U		46 x 50	400	31.5	33.5	75	80	35.0	39.0	800	1

"AF"

Code	No.	mm	L	a ₁	a ₂	b ₁	b ₂	c ₁	c ₂	↕	☑
6057940	400 5/16x3/8AF	5/16 x 3/8	140	6.5	8.0	18	20	6.0	7.0	43	1
6058080	400 3/8x7/16AF	3/8 x 7/16	150	8.0	8.5	20	22	7.0	8.5	57	1
6058160	400 7/16x1/2AF	7/16 x 1/2	160	8.5	10.5	22	26	8.5	10.0	76	1
6058240	400 1/2x9/16AF	1/2 x 9/16	170	9.5	11.2	24	28	10.0	11.0	92	1
6058320	400 9/16x5/8AF	9/16 x 5/8	195	11.2	12.2	28	32	11.0	13.0	129	1
6058400	400 5/8x3/4AF	5/8 x 3/4	210	12.2	13.2	32	35	13.0	15.0	178	1
6056700	400 3/4x7/8AF	3/4 x 7/8	230	13.2	15.2	35	41	15.0	17.0	235	1
6058590	400 7/8x1AF	7/8 x 1	250	15.2	16.2	41	45	17.0	19.0	304	1

304

HALF-MOON RING SPANNER

- Thin walled, polished rings
- GEDORE vanadium steel 31CrV3, chrome-plated

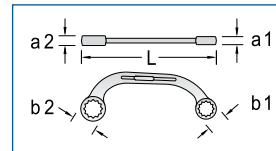
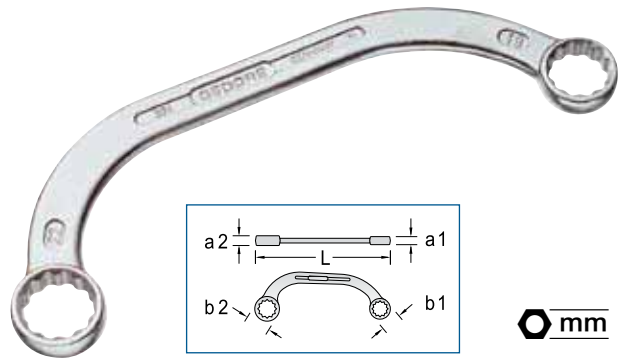

mm

Code	No.	mm	L	a ₁	a ₂	b ₁	b ₂	↕	☑
6470040	304 11x13	11 x 13	150	7.0	7.5	17.0	20.5	77	10
6470630	304 13x15	13 x 15	185	8.5	8.5	20.5	23.0	129	10
6470120	304 13x17	13 x 17	185	8.5	8.5	20.5	25.5	140	10
6470200	304 14x16	14 x 16	185	8.5	8.5	21.5	24.5	137	10
6470390	304 14x17	14 x 17	185	8.5	8.5	21.5	25.5	144	10
6470470	304 15x17	15 x 17	185	8.5	8.5	23.0	25.5	150	10
6567550	304 16x18	16 x 18	185	8.5	8.5	24.5	27.0	163	10
6470550	304 19x22	19 x 22	230	10.0	10.5	28.0	32.5	261	10

"AF"

Code	No.	"AF"	L	a ₁	a ₂	b ₁	b ₂	↕	☑
6471010	304 7/16x1/2AF	7/16 x 1/2	150	7.0	7.5	17.0	20.5	79	5
6471280	304 9/16x5/8AF	9/16 x 5/8	185	8.5	8.5	21.5	24.5	139	5
6471360	304 5/8x3/4	5/8 x 3/4	230	10.0	10.5	24.5	28.0	219	1
6471440	304 3/4x7/8AF	3/4 x 7/8	230	10.0	10.5	28.0	32.5	247	1



SLOGGING SPANNERS "POWERFUL"

133

OPEN ENDED SLOGGING SPANNER

- ▶ For very heavy-duty work
- ▶ Acc. to DIN 133
- ▶ Up to length 500 mm chrome-vanadium steel 31CrV3, above 525 mm material C35
- ▶ Special sizes available on request
- ▶ * not standardised
- ▶ Top-grade industrial quality for the hardest of continuous use

Spanner sizes:

- ▶ Metric dimensions: 22 - 220 mm
- ▶ Imperial dimensions: 7/8" - 6"
- ▶ Whitworth dimensions: 9/16 W - 3 1/2 W

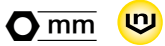

mm	"AF	Whitw.
22	7/8"	9/16"
220	6"	3 1/2"

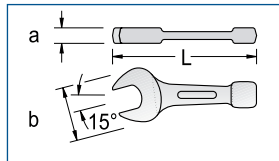

Code	No.	*	U	O mm	L	a	b	↕	⊞
1542842	133 22	*	U	22	180	16.0	55.0	280	1
1784056	133 24	*	U	24	180	16.0	55.0	280	1
2316609	133 25	*	U	25	180	16.0	55.0	320	1
1331752	133 26	*	U	26	180	16.0	57.0	210	1
6410570	133 27	*	U	27	180	16.5	57.5	385	1
1784080	133 28	*	U	28	180	16.0	57.0	280	1
1421298	133 29	*	U	29	180	16.0	57.0	280	1
6400260	133 30	*	U	30	190	17.0	63.5	451	1
2316617	133 31	*	U	31	190	17.0	62.0	440	1
6400340	133 32	*	U	32	195	17.5	66.5	552	1
5060600	133 33	*	U	33	190	17.0	62.0	430	1
6411030	133 34	*	U	34	195	17.5	66.5	559	1
5376750	133 35	*	U	35	215	19.0	76.0	745	1
6400420	133 36	*	U	36	210	18.5	75.5	709	1
5348890	133 37	*	U	37	215	19.0	76.0	740	1
5259440	133 38	*	U	38	215	19.0	76.0	680	1
5523480	133 39	*	U	39	215	19.0	76.0	680	1
1784102	133 40	*	U	40	235	19.0	86.0	900	1
6400500	133 41	*	U	41	225	19.5	88.0	1000	1
5012710	133 42	*	U	42	235	19.0	86.0	900	1
5295830	133 43	*	U	43	235	19.0	86.0	900	1
5523210	133 44	*	U	44	235	19.0	86.0	900	1
2316625	133 45	*	U	45	255	20.0	98.0	1200	1
6400690	133 46	*	U	46	255	20.0	98.0	1258	1
5262740	133 47	*	U	47	255	20.0	98.0	1200	1
5348970	133 48	*	U	48	255	20.0	98.0	1275	1
2316633	133 49	*	U	49	275	21.0	105.0	1200	1
6400770	133 50	*	U	50	280	21.5	108.0	1609	1
1784137	133 51	*	U	51	275	21.0	105.0	1450	1
5259520	133 52	*	U	52	275	21.0	105.0	1450	1
2316641	133 53	*	U	53	275	21.0	105.0	1450	1
5349000	133 54	*	U	54	300	23.0	116.0	1900	1
6400850	133 55	*	U	55	310	24.0	118.5	2131	1
5349190	133 56	*	U	56	300	23.0	116.0	1900	1
1455567	133 57	*	U	57	300	23.0	116.0	1900	1
5526820	133 58	*	U	58	300	23.0	116.0	1900	1
1784153	133 59	*	U	59	320	25.0	128.0	2600	1
6400930	133 60	*	U	60	320	24.5	129.5	2484	1
1542850	133 61	*	U	61	320	25.0	128.0	2600	1
5376670	133 62	*	U	62	320	25.0	128.0	2600	1
5333000	133 63	*	U	63	320	25.0	128.0	2600	1
2316668	133 64	*	U	64	345	27.0	138.0	3300	1
6401070	133 65	*	U	65	350	28.0	140.5	3340	1
1784161	133 66	*	U	66	342	27.0	138.0	3300	1

Code	No.	*	U	O mm	L	a	b	↕	⊞
5349270	133 67	*	U	67	342	27.0	138.0	3300	1
2316676	133 68	*	U	68	342	27.0	138.0	3300	1
1485377	133 69	*	U	69	375	30.0	154.0	4200	1
6401150	133 70	*	U	70	370	30.0	151.0	4325	1
1784196	133 71	*	U	71	375	30.0	154.0	4200	1
1550179	133 72	*	U	72	375	30.0	154.0	4200	1
1815857	133 73	*	U	73	375	30.0	154.0	4000	1
1815423	133 74	*	U	74	375	30.0	154.0	4100	1
6401230	133 75	*	U	75	400	31.5	163.0	5110	1
1550187	133 76	*	U	76	375	30.0	154.0	4100	1
1784218	133 77	*	U	77	375	30.0	154.0	4100	1
1691902	133 78	*	U	78	375	30.0	154.0	4100	1
1542877	133 79	*	U	79	408	34.0	174.0	5800	1
6401310	133 80	*	U	80	405	34.5	174.0	6020	1
2316684	133 81	*	U	81	408	34.0	174.0	5800	1
2316692	133 82	*	U	82	408	34.0	174.0	800	1
2316706	133 83	*	U	83	408	34.0	174.0	5800	1
1825089	133 84	*	U	84	408	34.0	174.0	5800	1
6401580	133 85	*	U	85	405	34.5	174.0	5770	1
2316714	133 86	*	U	86	408	34.0	174.0	5700	1
2316722	133 87	*	U	87	408	34.0	174.0	5700	1
1494058	133 88	*	U	88	408	34.0	174.0	5700	1
2316730	133 89	*	U	89	445	38.0	194.0	7800	1
6401660	133 90	*	U	90	455	39.0	195.0	8905	1
2316749	133 91	*	U	91	445	38.0	194.0	7800	1
2316757	133 92	*	U	92	445	38.0	194.0	7800	1
2316765	133 93	*	U	93	445	38.0	194.0	7800	1
2316773	133 94	*	U	94	445	38.0	194.0	7800	1
6401740	133 95	*	U	95	455	39.0	195.0	8985	1
1597566	133 96	*	U	96	445	38.0	194.0	7700	1
1784226	133 97	*	U	97	445	38.0	194.0	7700	1
1813978	133 98	*	U	98	485	44.0	215.0	11150	1
2316781	133 99	*	U	99	485	44.0	215.0	11150	1
6401820	133 100	*	U	100	500	47.0	227.0	13315	1
2316803	133 101	*	U	101	485	44.0	215.0	11150	1
2316811	133 102	*	U	102	485	44.0	215.0	11150	1
2316838	133 103	*	U	103	485	44.0	215.0	11150	1
2316846	133 104	*	U	104	485	44.0	215.0	11150	1
6401900	133 105	*	U	105	500	47.0	227.0	13220	1
1813986	133 106	*	U	106	485	44.0	215.0	11050	1
2316854	133 107	*	U	107	485	44.0	215.0	11050	1
2316862	133 108	*	U	108	510	47.0	235.0	14100	1
2316870	133 109	*	U	109	510	47.0	235.0	14100	1
6402040	133 110	*	U	110	500	47.0	227.0	13045	1



306 G

RING SLOGGING SPANNER DEEP OFFSET

- For very heavy-duty work
- To use with club hammer or pneumatic hammer for tightening or loosening
- Hot forged, sandblasted
- Top-grade industrial quality for the hardest of continuous use

Spanner sizes:

- Metric dimensions: 27 - 115 mm
- Imperial dimensions: 1.1/16" - 4.5/8"
- Whitworth dimensions: 9/16 W - 2 W

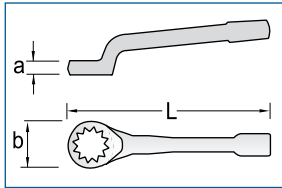

mm

mm	"AF	Whitw.
27	1 1/16"	9/16"
115	4 5/8"	2"

"AF

Code	No.		mm	L	a	b		
1415875	306 G 27		27	270	25.0	51.0	1098	1
1415913	306 G 30		30	270	25.0	51.0	1080	1
1415972	306 G 32		32	270	25.0	51.0	1061	1
1416014	306 G 36		36	310	30.0	67.0	2010	1
1541439	306 G 38		38	310	30.0	67.0	1900	1
1665006	306 G 39		39	310	330.0	67.0	1900	1
1416057	306 G 41		41	310	30.0	67.0	1842	1
1541447	306 G 43		43	340	35.0	79.0	1900	1
1416111	306 G 46		46	340	35.0	79.0	2950	1
1416197	306 G 50		50	360	40.0	94.0	4410	1
1416227	306 G 55		55	360	40.0	94.0	4155	1
1416308	306 G 60		60	380	45.0	108.0	5690	1
1416332	306 G 65		65	380	45.0	108.0	5490	1
1416405	306 G 70		70	406	50.0	126.0	7455	1
1416456	306 G 75		75	406	50.0	126.0	7165	1
1416480	306 G 80		80	406	50.0	126.0	6970	1
1416537	306 G 85		85	459	57.0	151.0	10630	1
1416553	306 G 90		90	459	57.0	151.0	10480	1
1416588	306 G 95		95	459	57.0	151.0	9830	1
1416618	306 G 100		100	459	57.0	151.0	9700	1
1416642	306 G 105		105	510	68.0	172.0	16100	1
1416669	306 G 110		110	510	68.0	172.0	13565	1
1416685	306 G 115		115	510	68.0	173.0	16100	1

Whitw.

Code	No.		mm	L	a	b		
1415905	306 G 9/16W		9/16	270	25.0	51.0	1130	1
1415891	306 G 5/8W		5/8	270	25.0	51.0	1118	1
1415956	306 G 11/16W		11/16	270	25.0	51.0	1103	1
1415999	306 G 3/4W		3/4	270	25.0	51.0	1061	1
1416030	306 G 13/16W		13/16	310	30.0	67.0	1993	1
1416073	306 G 7/8W		7/8	310	30.0	67.0	1942	1
1416103	306 G 15/16W		15/16	310	30.0	67.0	1901	1
1416146	306 G 1W		1	340	35.0	79.0	3030	1
1416162	306 G 1.1/8W		1.1/8	340	35.0	79.0	2885	1
1416219	306 G 1.1/4W		1.1/4	360	40.0	94.0	4350	1
1416243	306 G 1.3/8W		1.3/8	360	40.0	94.0	4130	1
1416324	306 G 1.1/2W		1.1/2	380	45.0	108.0	5665	1
1416367	306 G 1.5/8W		1.5/8	380	45.0	108.0	5555	1
1416448	306 G 1.3/4W		1.3/4	406	50.0	126.0	7405	1
1416472	306 G 1.7/8W		1.7/8	406	50.0	126.0	7105	1
1416502	306 G 2W		2	406	50.0	126.0	6865	1

Code	No.		"AF	L	a	b		
1415883	306 G 1.1/16AF		1.1/16	270	25.0	51.0	1111	1
1415948	306 G 1.1/8AF		1.1/8	270	25.0	51.0	1104	1
1415964	306 G 1.3/16AF		1.3/16	270	25.0	51.0	1094	1
1415980	306 G 1.1/4AF		1.1/4	270	25.0	51.0	1084	1
1416006	306 G 1.5/16AF		1.5/16	270	25.0	51.0	1066	1
1416049	306 G 1.3/8AF		1.3/8	310	30.0	67.0	1982	1
1416022	306 G 1.7/16AF		1.7/16	310	30.0	67.0	1945	1
1416065	306 G 1.1/2AF		1.1/2	310	30.0	67.0	1957	1
1416081	306 G 1.5/8AF		1.5/8	310	30.0	67.0	1910	1
1416138	306 G 1.11/16AF		1.11/16	340	35.0	79.0	3015	1
1416154	306 G 1.3/4AF		1.3/4	340	35.0	79.0	2975	1
1416170	306 G 1.13/16AF		1.13/16	340	35.0	79.0	2975	1
1416189	306 G 1.7/8AF		1.7/8	340	35.0	79.0	2885	1
1416200	306 G 1.15/16AF		1.15/16	360	40.0	94.0	4285	1
1416235	306 G 2AF		2	360	40.0	94.0	4250	1
1416278	306 G 2.1/16AF		2.1/16	360	40.0	94.0	4190	1
1416251	306 G 2.1/8AF		2.1/8	360	40.0	94.0	4130	1
1416286	306 G 2.3/16AF		2.3/16	360	40.0	94.0	4150	1
1416294	306 G 2.1/4AF		2.1/4	360	40.0	94.0	4070	1
1416316	306 G 2.5/16AF		2.5/16	380	45.0	108.0	5680	1
1416359	306 G 2.3/8AF		2.3/8	380	45.0	108.0	5600	1
1680455	306 G 2.7/16AF		2.7/16	380	45.0	108.0	5500	1
1416375	306 G 2.1/2AF		2.1/2	380	45.0	108.0	5475	1
1416383	306 G 2.9/16AF		2.9/16	380	45.0	108.0	5455	1
1416391	306 G 2.5/8AF		2.5/8	380	45.0	108.0	5455	1
1416413	306 G 2.3/4AF		2.3/4	406	50.0	126.0	7475	1
1416464	306 G 2.7/8AF		2.7/8	406	50.0	126.0	7305	1
1416499	306 G 2.15/16AF		2.15/16	406	50.0	126.0	7205	1
1416510	306 G 3AF		3	406	50.0	126.0	7130	1
1416529	306 G 3.1/8AF		3.1/8	406	50.0	126.0	6915	1
1416545	306 G 3.3/8AF		3.3/8	459	57.0	151.0	10450	1
1416561	306 G 3.1/2AF		3.1/2	459	57.0	151.0	10400	1
1416596	306 G 3.3/4AF		3.3/4	459	57.0	151.0	10600	1
1416626	306 G 3.7/8AF		3.7/8	459	57.0	151.0	9650	1
1416634	306 G 4AF		4	459	57.0	151.0	9355	1
1416650	306 G 4.1/8AF		4.1/8	510	68.0	172.0	16100	1
1416677	306 G 4.1/4AF		4.1/4	510	68.0	172.0	16100	1
1416693	306 G 4.1/2AF		4.1/2	510	68.0	172.0	16100	1
1416707	306 G 4.5/8AF		4.5/8	510	68.0	172.0	16100	1



DEEP RING SPANNERS

"STRONG"

308

DEEP RING SPANNER straight pattern

- Acc. to DIN 3111
- In heat-treated steel as per EN 10083, shotblast finish
- Further sizes available on request
- * not standardised
- Top-grade industrial quality for the hardest of continuous use

Spanner sizes:

- Metric dimensions: 13 - 95 mm
- Imperial dimensions: 13/16" - 3.1/8"
- Whitworth dimensions: 9/16 W - 1 3/8 W



mm	"AF	Whitw.
13	13/16"	9/16"
95	3 1/8"	1 3/8"

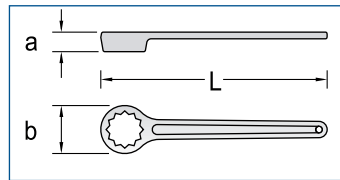

Code	No.	*	W	O mm	L	a	b	↕	☒
2314320	308 13	*	W	13	138	8.3	25.0	80	1
2314339	308 14	*	W	14	138	8.3	25.0	80	1
2314347	308 15	*	W	15	138	8.3	25.0	80	1
2314363	308 16	*	W	16	155	9.5	31.0	80	1
2314371	308 17	*	W	17	155	9.5	31.0	80	1
2314398	308 18	*	W	18	155	9.5	31.0	80	1
2314401	308 19	*	W	19	171	11.5	34.0	100	1
2314428	308 20	*	W	20	171	11.5	34.0	100	1
2314444	308 21	*	W	21	190	13.0	37.5	140	1
1806521	308 22	*	W	22	190	13.0	37.5	140	1
1793659	308 24	*	W	24	215	15.0	38.5	200	1
2106140	308 25	*	W	25	215	15.0	38.5	200	1
2106167	308 26	*	W	26	230	16.0	41.5	240	1
1537849	308 27	*	W	27	230	16.0	41.5	240	1
2106175	308 28	*	W	28	230	16.0	41.5	240	1
2106183	308 29	*	W	29	254	18.0	47.5	300	1
1606255	308 30	*	W	30	254	18.0	47.5	300	1
6481750	308 32	*	W	32	265	19.0	49.0	358	1
2106191	308 33	*	W	33	265	19.0	49.0	350	1
2106205	308 34	*	W	34	295	22.0	56.0	500	1
6481830	308 36	*	W	36	295	22.0	56.0	473	1

Code	No.	*	W	O mm	L	a	b	↕	☒
2106213	308 38	*	W	38	295	22.0	56.0	500	1
1606263	308 39	*	W	39	330	25.0	63.5	700	1
6481910	308 41	*	W	41	330	25.0	63.5	717	1
2106221	308 43	*	W	43	330	25.0	63.5	700	1
2314452	308 44	*	W	44	365	27.0	70.5	950	1
6482050	308 46	*	W	46	365	27.0	70.5	925	1
2314460	308 47	*	W	47	365	27.0	70.5	950	1
6482130	308 50	*	W	50	400	28.0	77.0	1230	1
2314479	308 52	*	W	52	400	28.0	77.0	1300	1
6482210	308 55	*	W	55	445	29.5	83.5	1626	1
2314487	308 56	*	W	56	442	29.5	83.5	1550	1
2314495	308 57	*	W	57	442	29.5	83.5	1550	1
2314509	308 58	*	W	58	442	29.5	83.5	1550	1
6482480	308 60	*	W	60	475	30.0	89.5	1792	1
6482560	308 65	*	W	65				2208	1
6482640	308 70	*	W	70	555	35.0	106.0	2600	1
6482720	308 75	*	W	75	590	38.0	114.0	3200	1
6482800	308 80	*	W	80	620	40.0	120.5	3800	1
6482990	308 85	*	W	85	665	42.0	127.5	4400	1
1812629	308 90	*	W	90	698	45.0	135.5	5800	1
1558285	308 95	*	W	95	700	45.0	140.0	5500	1



Code	No.	W	O AF	L	a	b	↕	☒
2314517	308 13/16AF	W	13/16	171	11.5	34.0	100	1
2314525	308 7/8AF	W	7/8	215	15.0	38.5	140	1
2314541	308 15/16AF	W	15/16	215	15.0	38.5	200	1
2314568	308 1.1/16AF	W	1.1/16	230	16.0	41.5	240	1
2314576	308 1.1/8AF	W	1.1/8	230	16.0	41.5	240	1
2314606	308 1.1/4AF	W	1.1/4	265	19.0	49.0	350	1
2314614	308 1.5/16AF	W	1.5/16	265	19.0	49.0	350	1
2314622	308 1.3/8AF	W	1.3/8	295	22.0	56.0	500	1
2314630	308 1.1/2AF	W	1.1/2	295	22.0	56.0	500	1
2314649	308 1.5/8AF	W	1.5/8	330	25.0	63.5	700	1
2314657	308 1.11/16AF	W	1.11/16	330	25.0	63.5	700	1
2314665	308 1.3/4AF	W	1.3/4	365	27.0	70.5	950	1
2314673	308 1.13/16AF	W	1.13/16	365	27.0	70.5	950	1
2314681	308 1.7/8AF	W	1.7/8	365	27.0	70.5	950	1
1922351	308 2AF	W	2	400	28.0	77.0	1300	1

Code	No.	W	O AF	L	a	b	↕	☒
2314703	308 2.1/4AF	W	2.1/4	442	29.5	83.5	1550	1
1924516	308 2.3/8AF	W	2.3/8	475	30.0	89.5	1800	1
2314711	308 2.1/2AF	W	2.1/2	510	32.0	97.0	2300	1
2314738	308 2.5/8AF	W	2.5/8	510	32.0	97.0	2300	1
2314746	308 2.3/4AF	W	2.3/4	555	35.0	106.0	2600	1
2314754	308 2.15/16AF	W	2.15/16	590	38.0	114.0	3200	1
2314762	308 3AF	W	3	590	38.0	114.0	3200	1
2314770	308 3.1/8AF	W	3.1/8	620	40.0	120.5	3800	1



Code	No.	W	Whitw.	L	a	b	↕	☒
2314789	308 9/16W	W	9/16	215	15.0	38.5	200	1
2314797	308 5/8W	W	5/8	230	16.0	41.5	240	1
2314800	308 1.3/8W	W	1.3/8	442	29.5	83.5	1550	1



"Strong"

2 A

SINGLE ENDED RING SPANNER offset

- Heavy-duty pattern for highest torques
- GEDORE vanadium steel 31CrV3, polished ring, chrome-plated
- Top-grade industrial quality for the hardest of continuous use
- Optional accessories: No. 2 AR extension tube for extending the lever arm

Spanner sizes:

- Metric dimensions: 22 - 105 mm
- Imperial dimensions: 7/8" - 4 1/8"
- Whitworth dimensions: 1/2 W - 2 1/2 W

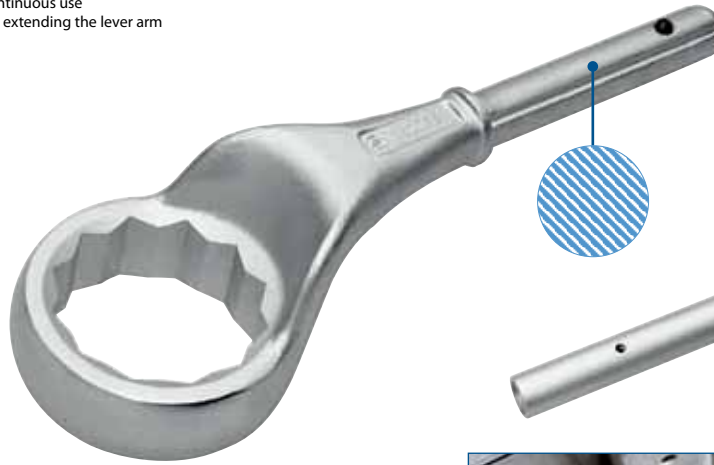
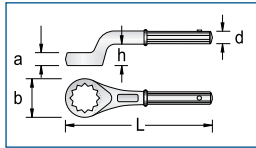

mm	"AF	Whitw.
22	7/8"	1/2"
105	4 1/8"	2 1/2"

Code	No.	W	mm	L	a	b	d	h	W	W
1449354	2 A 22	W	22	180	17.0	36.0			380	1
6033840	2 A 24	W	24	180	17.0	38.0	18.3	29.0	389	1
1607154	2 A 25	W	25	180	17.0	38.0			380	1
1505785	2 A 26	W	26	190	17.0	42.0			430	1
6033920	2 A 27	W	27	190	17.4	42.0	18.3	31.5	430	1
1505793	2 A 28	W	28	190	17.0	42.0			430	1
6034060	2 A 30	W	30	200	18.4	47.0	18.3	33.0	514	1
1607162	2 A 29	W	29	200	18.4	47.0			550	1
1505807	2 A 31	W	31	200	18.4	47.0			700	1
6034140	2 A 32	W	32	235	18.4	50.0	21.3	34.0	732	1
1505815	2 A 33	W	33	235	18.4	50.0			700	1
6030150	2 A 34	W	34	235	18.4	50.0	21.3	34.0	748	1
2315858	2 A 35	W	35	245	20.0	55.0			840	1
6034220	2 A 36	W	36	245	20.0	55.0	21.3	35.0	796	1
1607219	2 A 37	W	37	245	20.0	55.0			840	1
1588710	2 A 38	W	38							1
1407112	2 A 39	W	39	250	21.0	55.0			850	1
6034300	2 A 41	W	41	265	22.0	61.5	21.3	39.0	934	1
1485407	2 A 40	W	40	265	22.0	61.5			1000	1
1459163	2 A 42	W	42	265	22.0	61.5			1000	1
2315866	2 A 43	W	43	265	22.0	61.5			1000	1
2315874	2 A 44	W	44	280	23.0	68.5			1300	1
2315882	2 A 45	W	45	280	23.0	68.5			1300	1
6034490	2 A 46	W	46	280	23.0	68.5	24.1	40.0	1220	1
2315890	2 A 47	W	47	280	23.0	68.5			1300	1
1433978	2 A 48	W	48	290	25.5	75.0			1450	1
2315904	2 A 49	W	49	290	25.5	75.0			1450	1
6034570	2 A 50	W	50	290	25.5	75.0	24.1	42.0	1388	1
1813870	2 A 51	W	51	290	25.5	75.0			1450	1
1505823	2 A 52	W	52	290	25.5	75.0			1450	1
2315912	2 A 53	W	53	300	28.0	80.0			1500	1
2315920	2 A 54	W	54	300	28.0	80.0			1500	1
6034650	2 A 55	W	55	300	28.0	80.0	24.1	45.0	1492	1
1485415	2 A 56	W	56	300	28.0	80.0			1500	1
1505831	2 A 57	W	57	300	28.0	80.0			1500	1
1477781	2 A 58	W	58	300	28.0	80.0			1500	1
2315939	2 A 59	W	59	345	30.5	89.0			2300	1

Code	No.	W	mm	L	a	b	d	h	W	W
6034730	2 A 60	W	60	345	30.5	89.0	29.1	49.0	2283	1
2315947	2 A 61	W	61	345	30.5	89.0			2300	1
2315955	2 A 62	W	62	345	30.5	89.0			2300	1
1536346	2 A 63	W	63	345	30.5	89.0			2300	1
6034810	2 A 65	W	65	355	33.0	97.0	29.1	53.0	2535	1
1813897	2 A 64	W	64	355	33.0	97.0			2370	1
1505858	2 A 67	W	67	355	33.0	97.0			2370	1
1485423	2 A 68	W	68	355	33.0	97.0			2370	1
1485431	2 A 69	W	69	365	35.5	104.0			2800	1
6035030	2 A 70	W	70	365	35.5	104.0	29.1	55.0	2736	1
1422715	2 A 71	W	71	365	35.5	104.0			2800	1
2315963	2 A 72	W	72	375	38.0	109.0			3000	1
1813900	2 A 73	W	73	375	38.0	109.0			3000	1
1813919	2 A 74	W	74	375	38.0	109.0			3000	1
6035110	2 A 75	W	75	375	38.0	109.0	29.1	57.5	2982	1
2315971	2 A 76	W	76	375	38.0	109.0			3000	1
1422995	2 A 77	W	77	385	40.5	124.0			3500	1
1485458	2 A 78	W	78	385	40.5	124.0			3500	1
6035380	2 A 80	W	80	385	40.5	124.0	29.1	59.0	3770	1
2315998	2 A 81	W	81	385	40.5	124.0			3500	1
2316005	2 A 82	W	82	385	40.5	124.0			3500	1
6035460	2 A 85	W	85	385	40.5	124.0	29.1	59.0	3605	1
2316013	2 A 86	W	86	385	40.5	124.0			3500	1
2316021	2 A 87	W	87	410	45.0	140.0			4900	1
2316048	2 A 88	W	88	410	45.0	140.0			4900	1
6035540	2 A 90	W	90	410	45.0	140.0	29.1	63.0	4850	1
2316056	2 A 91	W	91	410	45.0	140.0			4900	1
2316064	2 A 94	W	94	410	45.0	140.0			4900	1
6035620	2 A 95	W	95	410	45.0	140.0	29.1	63.0	4540	1
1813927	2 A 96	W	96	410	45.0	140.0			4900	1
1813935	2 A 97	W	97	410	45.0	140.0			4900	1
1813943	2 A 98	W	98	410	45.0	140.0			4900	1
2316072	2 A 99	W	99	410	45.0	140.0			4900	1
6035700	2 A 100	W	100							1
2316080	2 A 102	W	102	412	45.0	142.0			4900	1
2316099	2 A 104	W	104	415	45.0	144.0			4900	1
2316102	2 A 105	W	105	415	45.0	144.0			4600	1



2 A

Code	No.	W	Ø ^{AF}	L	a	b	d	h	↕	☒
2316110	2 A 7/8AF	W	7/8	180	17.0	36.0			380	1
1505866	2 A 15/16AF	W	15/16	180	17.0	36.0			350	1
1505874	2 A 1AF	W	1							1
1490184	2 A 1.1/16AF	W	1.1/16							1
1456024	2 A 1.1/8AF	W	1.1/8	200	18.4	47.0			550	1
1505882	2 A 1.3/16AF	W	1.3/16	200	18.4	47.0			550	1
1425722	2 A 1.1/4AF	W	1.1/4	235	18.4	50.0			700	1
1490206	2 A 1.5/16AF	W	1.5/16	235	18.4	50.0			700	1
1490214	2 A 1.3/8AF	W	1.3/8	245	20.0	55.0			840	1
1425714	2 A 1.7/16AF	W	1.7/16	245	20.0	55.0			840	1
1490222	2 A 1.1/2AF	W	1.1/2							1
1490338	2 A 1.9/16AF	W	1.9/16	265	22.0	61.5			1000	1
1484265	2 A 1.5/8AF	W	1.5/8	265	22.0	61.5			1000	1
1490230	2 A 1.11/16AF	W	1.11/16	265	22.0	61.5			1000	1
1484273	2 A 1.3/4AF	W	1.3/4	280	23.0	68.5			1300	1
1425706	2 A 1.13/16AF	W	1.13/16	280	23.0	68.5			1300	1
1490249	2 A 1.7/8AF	W	1.7/8	280	23.0	68.5			1300	1
2316129	2 A 1.15/16AF	W	1.15/16	290	25.5	75.0			1450	1
1425692	2 A 2AF	W	2	290	25.5	75.0			1450	1
1490257	2 A 2.1/16AF	W	2.1/16	290	25.5	75.0			1450	1
2316137	2 A 2.1/8AF	W	2.1/8	300	28.0	80.0			1500	1
1482386	2 A 2.3/16AF	W	2.3/16	300	28.0	80.0			2800	1
1490265	2 A 2.1/4AF	W	2.1/4	300	28.0	80.0			1500	1



Code	No.	W	Ø ^{AF}	L	a	b	d	h	↕	☒
2316145	2 A 2.5/16AF	W	2.5/16	345	30.5	89.0			3000	1
1425684	2 A 2.3/8AF	W	2.3/8	345	30.5	89.0			2300	1
2316153	2 A 2.7/16AF	W	2.7/16	345	30.5	89.0			2300	1
2316161	2 A 2.1/2AF	W	2.1/2	355	33.0	97.0			2370	1
1425676	2 A 2.9/16AF	W	2.9/16	355	33.0	97.0			2370	1
1484311	2 A 2.5/8AF	W	2.5/8	355	33.0	97.0			2370	1
2316188	2 A 2.11/16AF	W	2.11/16	355	33.0	97.0			2370	1
1490273	2 A 2.3/4AF	W	2.3/4	365	35.5	104.0			2800	1
1505890	2 A 2.13/16AF	W	2.13/16	365	35.5	104.0			1500	1
1354140	2 A 2.7/8AF	W	2.7/8	375	38.0	109.0			3000	1
1490281	2 A 2.15/16AF	W	2.15/16	375	38.0	109.0			2300	1
1466690	2 A 3AF	W	3	375	38.0	109.0			3000	1
1490303	2 A 3.1/8AF	W	3.1/8	385	40.5	124.0			3500	1
2316196	2 A 3.1/4AF	W	3.1/4	385	40.5	124.0			3500	1
1813560	2 A 3.3/8AF	W	3.3/8	385	40.5	124.0			3500	1
2316218	2 A 3.1/2AF	W	3.1/2	410	45.0	140.0			4900	1
2316226	2 A 3.5/8AF	W	3.5/8	410	45.0	140.0			4900	1
2316234	2 A 3.3/4AF	W	3.3/4	410	45.0	140.0			4980	1
2316242	2 A 3.7/8AF	W	3.7/8	410	45.0	140.0			4900	1
2316250	2 A 4AF	W	4	410	45.0	140.0			4900	1
2316269	2 A 4.1/8AF	W	4.1/8	410	45.0	140.0			4900	1



Code	No.	W	Ø ^{Whitw.}	L	a	b	d	h	↕	☒
1505904	2 A 1/2W	W	1/2	180	17.0	38.0			380	1
2316277	2 A 9/16W	W	9/16	180	17.0	38.0			380	1
1505912	2 A 5/8W	W	5/8	190	17.0	42.0			430	1
1505920	2 A 11/16W	W	11/16	200	18.4	47.0			550	1
1505939	2 A 3/4W	W	3/4	235	18.4	50.0			700	1
2316285	2 A 13/16W	W	13/16	245	20.0	55.0			840	1
1452061	2 A 7/8W	W	7/8	245	20.0	55.0			840	1
2316293	2 A 15/16W	W	15/16	265	22.0	61.5			1000	1
1505947	2 A 1W	W	1	265	22.0	61.5			1000	1
1494295	2 A 1.1/8W	W	1.1/8	280	23.0	68.5			1300	1
1505955	2 A 1.1/4W	W	1.1/4	290	25.5	75.0			1450	1

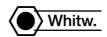

Code	No.	W	Ø ^{Whitw.}	L	a	b	d	h	↕	☒
1505963	2 A 1.3/8W	W	1.3/8	300	28.0	80.0			1500	1
1505971	2 A 1.1/2W	W	1.1/2	345	30.5	89.0			2300	1
1505998	2 A 1.5/8W	W	1.5/8	355	33.0	97.0			2370	1
1506005	2 A 1.3/4W	W	1.3/4	365	35.5	104.0			2800	1
2316307	2 A 1.7/8W	W	1.7/8	375	38.0	109.0			3000	1
2316315	2 A 2W	W	2	385	40.5	124.0			3500	1
2316323	2 A 2.1/4W	W	2.1/4	410	45.0	140.0			4900	1
2316331	2 A 2.1/2W	W	2.1/2	410	45.0	140.0			4900	1

2 AR

EXTENSION TUBE

- For ring spanner No. 2 A, steel tube, chrome-plated
- For extending the lever arm and applying higher forces



Code	No.	Internal-Ø	Ø mm	l-mm-l	↕	☒
6048600	2 AR 0	19	24-30	460	614	1
6048790	2 AR 1	22	32-41	610	1568	1
6048870	2 AR 2	25	46-55	760	2806	1
6048950	2 AR 3	30	60-95	860	3715	1



2 ATM

SINGLE ENDED RING SPANNER SET 19 pieces

- 15 spanners 2 A and 4 extension tubes on a sheet steel board fitted with hooks
- Dimensions: W 970 x H 740 mm



Code	No.	Contents	↕	☒
6049250	2 ATM	2 A 24 27 30 32 36 41 46 50 55 60 65 70 75 80 85 2 AR 0 1 2 3	61.0	1



CROWFOOT SPANNERS

3114 - DS 3114

CROWFOOT SPANNER

- Opening at right angle to shaft for maximum accessibility
- GEDORE vanadium steel 31CrV3, chrome-plated
- No. 3114 = without tommy bar
- No. DS 3114 = with tommy bar 26 D

Spanner sizes:

- Metric dimensions: 13 - 50 mm

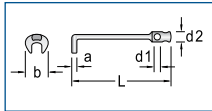
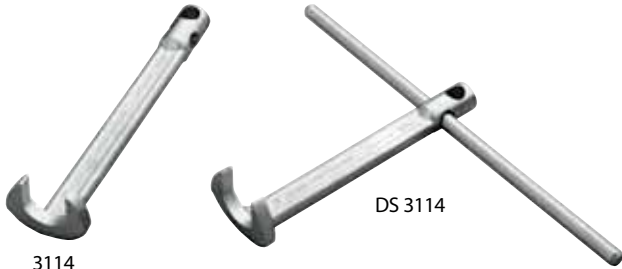

mm
13 - 50

Code	No.	Ømm	L	a	b	d ₁	d ₂	26 D	↔	☰
6670050	3114 13	13	160	5.5	28.0	8.5	13.8	-	95	1
6670130	3114 14	14	160	5.5	28.0	8.5	13.8	-	93	1
6676920	3114 16	16	200	6.0	33.0	10.5	16.8	-	160	1
6670210	3114 17	17	200	6.0	33.0	10.5	16.8	-	169	1
6677060	3114 18	18	200	7.0	37.0	12.5	19.6	-	216	1
6670480	3114 19	19	200	7.0	37.0	12.5	19.6	-	224	1
6677140	3114 21	21	200	8.0	42.0	12.5	19.6	-	272	1
6670560	3114 22	22	200	8.0	42.0	12.5	19.6	-	265	1
6670640	3114 24	24	250	9.0	46.0	14.5	23.6	-	419	1
6670720	3114 27	27	250	10.0	52.0	14.5	23.6	-	519	1
6670800	3114 30	30	250	11.0	57.0	16.5	27.6	-	633	1
6670990	3114 32	32	250	11.8	61.0	16.5	27.6	-	712	1
6671020	3114 36	36	315	12.8	68.0	19.0	31.5	-	1034	1
6671100	3114 41	41	315	14.0	76.0	19.0	31.0	-	1197	1
6671290	3114 46	46	315	15.0	85.0	21.0	34.0	-	1486	1
6671370	3114 50	50	315	15.0	92.0	21.0	34.0	-	1674	1
6672180	DS 3114 13	13	160	5.5	28.0	8.5	13.8	8	168	1
6672260	DS 3114 14	14	160	5.5	28.0	8.5	13.8	8	168	1
6677220	DS 3114 16	16	200	6.0	33.0	10.5	16.8	10	280	1
6672340	DS 3114 17	17	200	6.0	33.0	10.5	16.8	10	286	1
6677300	DS 3114 18	18	200	7.0	37.0	12.5	19.6	12	436	1
6672420	DS 3114 19	19	200	7.0	37.0	12.5	19.6	12	440	1
6677490	DS 3114 21	21	200	8.0	42.0	12.5	19.6	12	482	1
6672500	DS 3114 22	22	200	8.0	42.0	12.5	19.6	12	486	1
6672690	DS 3114 24	24	250	9.0	46.0	14.5	23.6	14	798	1
6672770	DS 3114 27	27	250	10.0	52.0	14.5	23.6	14	902	1
6672850	DS 3114 30	30	250	11.0	57.0	16.5	27.6	16	1256	1
6672930	DS 3114 32	32	250	11.8	61.0	16.5	27.6	16	1324	1
6673070	DS 3114 36	36	315	12.8	68.0	19.0	31.5	18	2016	1
6673150	DS 3114 41	41	315	14.0	76.0	19.0	31.0	18	2178	1
6673230	DS 3114 46	46	315	15.0	85.0	21.0	34.0	20	2940	1
6673310	DS 3114 50	50	315	15.0	92.0	21.0	34.0	20	3204	1

SWIVEL HEAD WRENCHES

534

COMBINATION SWIVEL HEAD WRENCH

- Slim pattern, with free moving socket wrench
- With hole for tommy bars 26 D and 26 RS
- GEDORE vanadium steel 31CrV3, chrome-plated, heads polished



Spanner sizes:

- Metric dimensions: 13 - 50 mm

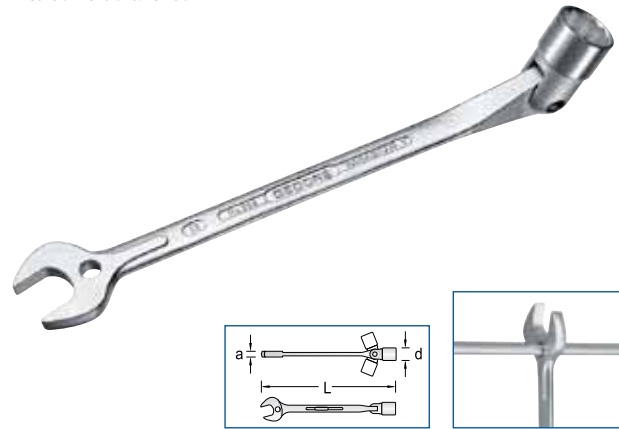

Code	No.	Ømm	L	a	d	26 RS	26 D	↔	☰
6512060	534 10	10	179	4.7	15.5	1	5	71	10
6512140	534 11	11	189	5.0	16.7	1	5	87	5
6512220	534 12	12	198	5.3	18.0	1	5	115	5
6512300	534 13	13	208	6.0	19.2	1	5	140	10
6512490	534 14	14	218	6.3	20.5	1	6	151	5
6512570	534 15	15	231	6.7	21.7	1	6	169	5
6512650	534 16	16	244	7.0	22.9	1	6	222	5
6512730	534 17	17	255	7.5	24.2	2	8	237	10
6513030	534 18	18	269	7.7	25.5	2	8	273	5
6512810	534 19	19	283	8.0	26.7	2	8	304	10

www.gedore.com



26 D



136



26 RS / 626 S



137





"Agile"



34

SWIVEL HEAD WRENCH DOUBLE ENDED

- Thin walled heads, UD profile
- Swivels through a wide radius
- Shaft with holes for tommy bars 26 D and 26 RS
- GEDORE vanadium steel 31CrV3, heads polished, chrome-plated



Spanner sizes:

- Metric dimensions: 6 x 7 - 30 x 32 mm
- Imperial dimensions: 3/8 x 7/16" - 15/16 x 1"



mm	"AF"
6 x 7	3/8" x 7/16"
30 x 32	15/16" x 1"

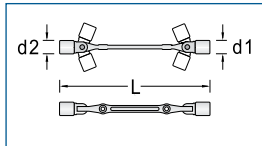

Code	No.	mm	L	d ₁	d ₂	26 D	26 RS	↕	☑
6301520	34 6x7	6 x 7	190	10.2	11.5	6	1	89	10
6299010	34 8x9	8 x 9	200	13.0	14.2	6	1	98	10
6299280	34 10x11	10 x 11	205	15.5	16.7	6	1	110	10
6299360	34 12x13	12 x 13	240	18.0	19.2	8	2	204	10
6299440	34 13x15	13 x 15	245	19.2	21.7	8	2	225	5
6299520	34 14x15	14 x 15	245	20.5	21.7	8	2	216	10
6298980	34 13x16	13 x 16	275	19.2	22.9	10	2	308	1
6299600	34 13x17	13 x 17	275	19.2	24.0	10	2	318	10
6299790	34 14x17	14 x 17	280	20.5	24.0	10	2	329	5
6299870	34 16x17	16 x 17	280	22.9	24.0	10	2	334	10
6300980	34 16x18	16 x 18	282	22.9	25.5	10	2	334	1
6299950	34 17x19	17 x 19	315	24.0	26.7	12	3	411	10
6300040	34 18x19	18 x 19	315	25.5	26.7	12	3	418	10
6301010	34 18x21	18 x 21	345	25.5	29.2	12	3	582	1
6300120	34 20x22	20 x 22	350	28.0	30.5	12	3	604	10
6300200	34 21x23	21 x 23	350	29.2	31.7	12	3	633	5
6300390	34 24x27	24 x 27	410	33.0	36.7	14	3	913	5
6300470	34 30x32	30 x 32	470	40.5	43.0	14	3	1361	1



Code	No.	AF	L	d ₁	d ₂	26 D	26 RS	↕	☑
6301600	34 3/8x7/16AF	3/8 x 7/16	205	14.9	16.7	6	1	110	5
6301790	34 1/2x9/16AF	1/2 x 9/16	245	18.7	20.7	8	2	216	5
6301870	34 19/32x11/16AF	19/32 x 11/16	280	21.7	24.7	10	2	314	1
6301950	34 5/8x3/4AF	5/8 x 3/4	315	22.5	26.7	12	3	405	1
6302090	34 13/16x7/8AF	13/16 x 7/8	350	28.5	30.6	12	3	598	1
6302170	34 15/16x1AF	15/16 x 1	410	32.6	34.6	14	3	862	1

TX 34

SWIVEL HEAD WRENCH DOUBLE ENDED

for protruding TORX® head screws

- Thin walled heads
- Swivels through a wide radius
- Shaft with holes for tommy bars 26 D and 26 RS
- GEDORE vanadium steel 31CrV3, heads polished, chrome-plated
- TORX® = reg. trademark of Acument Intellectual Properties, LLC. USA



Code	No.	mm	mm	mm	d ₁	d ₂	26 D	26 RS	↕	☑
6290570	TX 34 E6xE8	E6xE8	M5 - M7	5,74 x 7,52	190	8.5 10.8	6	1	86	1
6290650	TX 34 E10xE12	E10xE12	M8 - M10	9,42 x 11,17	230	13.5 15.5	8	2	184	1
6290730	TX 34 E14xE18	E14xE18	M12 - M14	12,98 x 16,68	265	17.0 21.0	10	2	299	1
6290810	TX 34 E20xE24	E20xE24	M16 - M20	18,47 x 22,14	295	23.5 28.5	12	3	407	1

ITX 34

SWIVEL HEAD WRENCH DOUBLE ENDED for recessed TORX® head screws

- Shaft with holes for tommy bars 26 D and 26 RS
- Swivel through a wide radius
- Sockets in GEDORE chrome-molybdenum steel 42CrMo4, phosphated, shaft chrome-plated
- TORX® = reg. trademark of Acument Intellectual Properties, LLC. USA



Code	No.	mm	mm	mm	26 D	26 RS	↕	☑	
6290060	ITX 34 T15xT20	T15xT20	M3,5 - M5	3,27 x 3,86	205	6	1	93	1
6290140	ITX 34 T25xT27	T25xT27	M4,5 - M6	4,43 x 4,99	208	6	1	92	1
6290220	ITX 34 T30xT40	T30xT40	M6 - M8	5,52 x 6,65	210	6	1	99	1
6290300	ITX 34 T45xT50	T45xT50	M8 - M10	7,82 x 8,83	244	8	2	185	1
6290490	ITX 34 T55xT60	T55xT60	M12 - M14	11,22 x 13,25	280	10	2	304	1

IN 34

SWIVEL HEAD WRENCH DOUBLE ENDED for in-hex screws

- Shaft with holes for tommy bars 26 D and 26 RS
- Swivel through a wide radius
- Sockets in GEDORE chrome-molybdenum steel 42CrMo4, phosphated, shaft chrome-plated

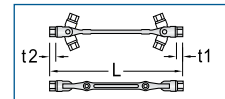

Code	No.	mm	L	t ₁	t ₂	26 D	26 RS	↕	☑
6302250	IN 34 3x4	3 x 4	198	4.0	5	6	1	101	5
6302330	IN 34 5x6	5 x 6	202	5.0	6	6	1	107	5
6302410	IN 34 8x10	8 x 10	235	8.0	10	8	2	199	5
6302680	IN 34 12x14	12 x 14	270	10.0	12	10	2	336	5
6302760	IN 34 17x19	17 x 19	295	14.0	16	12	3	411	1



Code	No.	AF	L	t ₁	t ₂	26 D	26 RS	↕	☑
6302840	IN 34 1/8x5/32AF	1/8 x 5/32	198	4.0	5	6	1	98	1
6302920	IN 34 3/16x7/32AF	3/16 x 7/32	202	5.0	6	6	1	101	1
6303060	IN 34 1/4x5/16AF	1/4 x 5/16	235	6.5	8	8	2	199	1
6303140	IN 34 3/8x1/2AF	3/8 x 1/2	270	10.0	12	10	2	310	1
6303220	IN 34 9/16x5/8AF	9/16 x 5/8	295	14.0	16	12	3	402	1



SOCKET WRENCHES

25

SOCKET WRENCH offset

- ✔ Solid pattern with extra deep socket for protruding bolts
- ✔ With dome for pointed screw heads
- ✔ Sizes 55 - 70 without dome (dimension a₂)
- ✔ GEDORE vanadium steel 31CrV3, chrome-plated

Spanner sizes:

- ✔ Metric dimensions: 10 - 70 mm

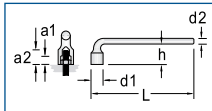
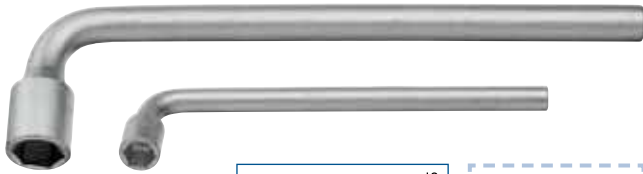

mm
10 - 70

Code	No.	Ø mm	L	a ₁	a ₂	d ₁	d ₂	h	↔	⊞
6188290	25 10	10	160	9.6	16.5	15,0	10	32	120	5
6188530	25 13	13	200	12.7	23.0	19,0	12	41	220	10
6188610	25 14	14	215	13.7	24.0	20,5	12	44	247	5
6196200	25 16	16	240	11.0	25.5	23,5	14	49	346	1
6188880	25 17	17	250	12.0	26.0	25,0	14	49	373	10
6196470	25 18	18	265	13.5	27.5	26,0	16	56	487	1
6188960	25 19	19	280	15.4	29.0	27,5	16	56	539	10
6196550	25 21	21	305	15.5	32.5	30,5	18	64	722	1
6189180	25 22	22	315	16.4	32.5	32,0	18	64	797	5
6196630	25 23	23	330	17.5	35.5	33,0	20	71	983	1
6189260	25 24	24	345	19.5	37.1	34,5	20	71	1055	5
6189340	25 27	27	380	21.4	37.5	38,5	20	74	1179	5
6189420	25 30	30	420	22.3	41.3	42,0	22	84	1536	5
6189500	25 32	32	450	26.5	43.2	45,0	22	87	633	1
6189690	25 36	36	500	27.3	47.1	50,0	26	97	2523	5
6189770	25 41	41	560	30.3	49.7	56,0	26	106	2940	1
6189850	25 46	46	630	33.4	56.5	62,0	28	114	3785	1
6189930	25 50	50	630	35.9	61.5	67,0	32	128	4900	1
6190000	25 55	55	670	38.0		74,0	34	120	5685	1
6190190	25 60	60	670	40.0		81,0	34	125	5770	1
6190270	25 65	65	750	42.8		88,0	40	130	8930	1
6190350	25 70	70	750	46.0		94,0	40	135	9200	1

25 V

SOCKET WRENCH offset

- ✔ Solid pattern with extra deep socket
- ✔ GEDORE vanadium steel 31CrV3, chrome-plated

Spanner sizes:

- ✔ Metric dimensions: 8 - 17 mm

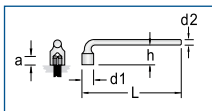

mm
8 - 17

Code	No.	Ø mm	L	a	d ₁	d ₂	h	↔	⊞
6194770	25 V 8	8	150	11.0	15,0	10	32.0	116	10
6194850	25 V 9	9	160	11.0	16,5	10	35.0	126	10
6194930	25 V 10	10	175	12.0	19,0	12	37.5	203	10
6195150	25 V 12	12	215	14.5	22,0	14	44.0	335	5
6195230	25 V 13	13	230	20.5	23,5	14	47.0	357	5
6195310	25 V 14	14	240	21.5	25,0	14	49.0	378	5
6195580	25 V 17	17	280	26.5	30,0	18	62.0	718	5



25 PK

DOUBLE ENDED SOCKET WRENCH offset with hole

- ✔ Solid pattern with two hexagon heads
- ✔ Deep bores above the hexagon heads to take long studs
- ✔ Through-hole on the angled side to take a tommy bar
- ✔ Chrome-plated

Spanner sizes:

- ✔ Metric dimensions: 6 - 36 mm



mm
6 - 36

Code	No.	Ø mm	L	a ₁	a ₂	d ₁	↔	⊞
1616323	25 PK 6	6	105	9	26.5	13,0	80	10
1616331	25 PK 7	7	107	9	26.5	14,0	81	10
1616358	25 PK 8	8	112	10	26.5	14,0	91	10
1436805	25 PK 9	9	120	10	26.5	14,0	99	10
1436813	25 PK 10	10	130	10	23.0	15,5	116	10
1436821	25 PK 11	11	136	10	23.0	16,5	122	10
1436848	25 PK 12	12	145	10	37.0	18,5	166	10
1436856	25 PK 13	13	152	11	35.0	20,0	192	10
1436864	25 PK 14	14	160	12	38.0	21,0	216	10
1616366	25 PK 15	15	170	13	38.0	22,5	239	10
1436872	25 PK 16	16	178	15	34.0	24,0	275	10
1436899	25 PK 17	17	187	15	35.0	25,5	305	10
1436902	25 PK 18	18	195	18	39.0	26,5	385	10
1436910	25 PK 19	19	205	17	38.0	28,0	440	10
1436929	25 PK 21	21	225	18	47.0	32,0	620	10
1436937	25 PK 22	22	225	18	47.0	32,0	632	10
1436945	25 PK 24	24	248	22	37.0	35,5	814	1
1436953	25 PK 27	27	280	26	60.0	38,0	1088	1
1436961	25 PK 30	30	310	27	64.0	42,0	1500	1
1436988	25 PK 32	32	330	30	63.0	45,0	1475	1
1436996	25 PK 34	34	340	32	67.0	47,0	1580	1
1437003	25 PK 36	36	355	33	74.0	50,0	2052	1



26 D



136



"Solid"



3112 - DS 3112

SOCKET WRENCH solid, short pattern

- Very heavy-duty pattern
- Acc. to DIN 3112, ISO 2236
- GEDORE vanadium steel 31CrV3, phosphated
- No. 3112 = without tommy bar
- No. DS 3112 = with tommy bar 26 D

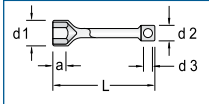
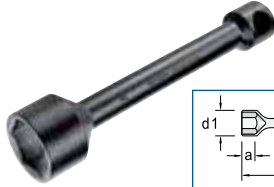

Code	No.	Ømm	L	a	d ₁	d ₂	d ₃	26 D	↕	☒
6667260	3112 55	55	355	38	74	45	26	-	2815	1
6667340	3112 60	60	355	40	80	45	26	-	2955	1
6667420	3112 65	65	400	43	88	58	33	-	4740	1
6667500	3112 70	70	400	46	94	58	33	-	4845	1
6667690	3112 75	75	400	49	101	58	33	-	5045	1
6667770	3112 80	80	400	52	108	58	33	-	5700	1
6667850	3112 85	85	450	55	114	70	41	-	7625	1
6668070	3112 95	95	450	62	128	70	41	-	8325	1
6668150	DS 3112 55	55	355	38	74	45	26	25	5495	1
6668230	DS 3112 60	60	355	40	80	45	26	25	5635	1
6668310	DS 3112 65	65	400	43	88	58	33	32	9755	1
6668580	DS 3112 70	70	400	46	94	58	33	32	9650	1
6668660	DS 3112 75	75	400	49	101	58	33	32	9950	1
6668740	DS 3112 80	80	400	52	108	58	33	32	10250	1
6668820	DS 3112 85	85	450	55	114	70	41	40	17350	1
6669040	DS 3112 95	95	450	62	128	70	41	40	18350	1

35 A - DS 35 A

SOCKET WRENCH solid, short pattern

- Solid pattern
- Acc. to DIN 3112, ISO 2236
- With extra deep hexagon heads and ball catch
- GEDORE vanadium steel 31CrV3, manganese-phosphated
- No. 35 A = without tommy bar
- No. DS 35 A = with tommy bar

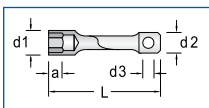

Code	No.	Ømm	L	a	d ₁	d ₂	d ₃	↕	☒
6304030	35 A 8	8	105	7.0	13.0	12	6.5	67	1
6304110	35 A 9	9	110	8.0	14.0	15	6.5	88	1
6304380	35 A 10	10	115	8.5	16.0	15	6.5	91	1
6304620	35 A 13	13	130	11.0	19.5	19	8.5	191	1
6304700	35 A 14	14	140	11.5	20.5	19	8.5	214	1
6303300	35 A 16	16	145	11.0	23.5	23	10.5	258	1
6305000	35 A 17	17	145	12.0	25.0	23	10.5	323	1
6303490	35 A 18	18	145	13.5	26.0	23	10.5	270	1
6305270	35 A 19	19	165	15.0	27.5	23	12.5	361	1
6303570	35 A 21	21	175	15.5	30.5	27	12.5	393	1
6305510	35 A 22	22	185	16.0	32.0	27	12.5	570	1
6305860	35 A 24	24	205	19.0	34.5	29	14.5	760	1
6306160	35 A 27	27	215	21.0	38.5	29	14.5	805	1
6306320	35 A 30	30	225	22.0	42.0	33	17.0	1124	1
6306670	35 A 36	36	260	27.0	50.0	37	19.0	1050	1
6306830	35 A 46	46	290	33.0	62.0	41	21.0	1710	1
6307130	DS 35 A 8	8	105	7.0	13.0	12	6.5	100	1
6307210	DS 35 A 9	9	110	8.0	14.0	15	6.5	114	1

Deviant packing units see article description.

Code	No.	Ømm	L	a	d ₁	d ₂	d ₃	↕	☒
6307480	DS 35 A 10	10	115	8.5	16.0	15	6.5	126	1
6307720	DS 35 A 13	13	130	11.0	19.5	19	8.5	259	1
6307800	DS 35 A 14	14	140	11.5	20.5	19	8.5	283	1
6300550	DS 35 A 16	16	145	11.0	23.5	23	10.5	379	1
6308100	DS 35 A 17	17	145	12.0	25.0	23	10.5	445	1
6300630	DS 35 A 18	18	145	13.5	26.0	23	10.5	391	1
6308370	DS 35 A 19	19	165	15.0	27.5	23	12.5	579	1
6300710	DS 35 A 21	21	175	15.5	30.5	27	12.5	610	1
6308610	DS 35 A 22	22	185	16.0	32.0	27	12.5	788	1
6308960	DS 35 A 24	24	205	19.0	34.5	29	14.5	1138	1
6309260	DS 35 A 27	27	215	21.0	38.5	29	14.5	1183	1
6309420	DS 35 A 30	30	225	22.0	42.0	33	17.0	1746	1
6309690	DS 35 A 36	36	260	27.0	50.0	37	19.0	2036	1
6309850	DS 35 A 46	46	290	33.0	62.0	41	21.0	3230	1

35 B - DS 35 B

SOCKET WRENCH solid, long pattern

- Solid pattern
- Acc. to DIN 3112, ISO 2236
- With extra deep hexagon heads and ball catch
- GEDORE vanadium steel 31CrV3, manganese-phosphated
- No. 35 B = without tommy bar
- No. DS 35 B = with tommy bar

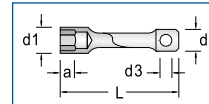
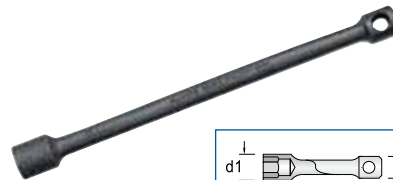

Code	No.	Ømm	L	a	d ₁	d ₂	d ₃	↕	☒
6310270	35 B 8	8	175	7.0	13.0	12	6.5	110	1
6310430	35 B 10	10	200	8.5	16.0	15	6.5	146	1
6310860	35 B 13	13	235	11.0	19.5	19	8.5	345	1
6310940	35 B 14	14	250	11.5	20.5	19	8.5	376	1
6310000	35 B 16	16	270	11.0	23.5	23	10.5	465	1
6311240	35 B 17	17	270	12.0	25.0	23	10.5	586	1
6310190	35 B 18	18	270	13.5	26.0	23	10.5	605	1
6311400	35 B 19	19	295	15.0	27.5	23	12.5	583	1
6310350	35 B 21	21	305	15.5	30.5	27	12.5	604	1
6311750	35 B 22	22	315	16.0	32.0	27	12.5	987	1
6311910	35 B 24	24	350	19.0	34.5	29	14.5	1231	1
6312210	35 B 27	27	390	21.0	38.5	29	14.5	1425	1
6312640	35 B 30	30	430	22.0	42.0	33	17.0	2113	1
6312720	35 B 32	32	440	26.0	45.0	33	17.0	2144	1
6312800	35 B 36	36	490	27.0	50.0	38	19.0	2182	1
6313290	DS 35 B 8	8	175	7.0	13.0	12	6.5	144	1
6313450	DS 35 B 10	10	200	8.5	16.0	15	6.5	179	1
6313880	DS 35 B 13	13	235	11.0	19.5	19	8.5	414	1
6313960	DS 35 B 14	13	250	11.5	20.5	19	8.5	445	1
6310510	DS 35 B 16	16	270	11.0	23.5	23	10.5	585	1
6314340	DS 35 B 17	17	270	12.0	25.0	23	10.5	707	1
6310780	DS 35 B 18	18	270	13.5	26.0	23	10.5	725	1
6314500	DS 35 B 19	19	295	15.0	27.5	23	12.5	801	1
6311080	DS 35 B 21	21	305	15.5	30.5	27	12.5	822	1
6314850	DS 35 B 22	19	315	16.0	32.0	27	12.5	1205	1
6315070	DS 35 B 24	24	350	19.0	34.5	29	14.5	1608	1
6315310	DS 35 B 27	24	390	21.0	38.5	29	14.5	1803	1
6315740	DS 35 B 30	30	430	22.0	42.0	33	17.0	2735	1
6315820	DS 35 B 32	32	440	26.0	45.0	33	17.0	2765	1
6315900	DS 35 B 36	36	490	27.0	50.0	38	19.0	3168	1



35 D



134



V 35 A - DSV 35 A

SOCKET WRENCH solid, short pattern

- ▶ Solid pattern
- ▶ With extra deep square heads and ball catch
- ▶ GEDORE vanadium steel 31CrV3, manganese-phosphated
- ▶ No. V 35 A = without tommy bar
- ▶ No. DSV 35 A = with tommy bar

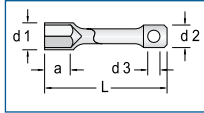

Code	No.	Ø mm	L	a	d ₁	d ₂	d ₃	↺↻	📦
6316200	V 35 A 6	6	80	12	11,5	12	6,5	52	1
6316390	V 35 A 7	7	80	15	13,5	15	8,5	72	1
6316470	V 35 A 8	8	80	15	14,0	15	8,5	72	1
6316550	V 35 A 9	9	100	18	16,0	17	10,5	115	1
6316630	V 35 A 10	10	100	18	17,5	17	10,5	121	1
6316710	V 35 A 11	11	100	19	21,0	21	12,5	187	1
6317010	V 35 A 13	13	100	22	23,5	23	12,5	231	1
6317280	V 35 A 14	14	120	24	26,0	25	14,5	339	1
6317520	V 35 A 17	17	160	28	31,0	31	17,0	698	1
6317790	V 35 A 19	19	200	30	34,0	31	17,0	901	1
6318090	V 35 A 22	22	200	34	39,0	36	19,0	1215	1
6318760	DSV 35 A 6	6	80	12	11,5	12	6,5	86	1
6318840	DSV 35 A 7	7	80	15	13,5	15	8,5	141	1
6318920	DSV 35 A 8	8	80	15	14,0	15	8,5	141	1
6319060	DSV 35 A 9	9	100	18	16,0	17	10,5	236	1
6319140	DSV 35 A 10	10	100	18	17,5	17	10,5	241	1
6319220	DSV 35 A 11	11	100	19	21,0	21	12,5	405	1
6319490	DSV 35 A 13	13	100	22	23,5	23	12,5	449	1
6319570	DSV 35 A 14	14	120	24	26,0	25	14,5	717	1
6319810	DSV 35 A 17	17	160	28	31,0	31	17,0	1319	1
6320150	DSV 35 A 19	19	200	30	34,0	31	17,0	1523	1
6320580	DSV 35 A 22	22	200	34	39,0	36	19,0	2201	1

V 35 B - DSV 35 B

SOCKET WRENCH solid, long pattern

- ▶ Solid pattern
- ▶ With extra deep square heads and ball catch
- ▶ GEDORE vanadium steel 31CrV3, manganese-phosphated
- ▶ No. V 35 B = without tommy bar
- ▶ No. DSV 35 B = with tommy bar

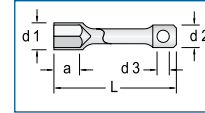
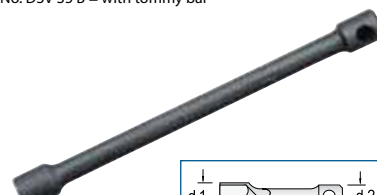

Code	No.	Ø mm	L	a	d ₁	d ₂	d ₃	↺↻	📦
6321120	V 35 B 6	6	160	12	11,5	12	6,5	105	1
6321200	V 35 B 7	7	160	15	13,5	15	8,5	145	1
6321390	V 35 B 8	8	160	15	14,0	15	8,5	143	1
6321470	V 35 B 9	9	200	18	16,0	17	10,5	239	1
6321550	V 35 B 10	10	200	18	17,5	17	10,5	246	1
6321710	V 35 B 12	12	200	20	22,0	21	12,5	386	1
6321980	V 35 B 13	13	200	22	23,5	23	12,5	477	1
6322010	V 35 B 14	14	200	24	26,0	25	14,5	555	1
6322440	V 35 B 17	17	250	28	31,0	31	17,0	116	1
6322600	V 35 B 19	19	320	30	34,0	31	17,0	1565	1
6322950	V 35 B 22	22	320	34	39,0	36	19,0	2072	1
6323680	DSV 35 B 6	6	160	12	11,5	12	6,5	139	1
6323760	DSV 35 B 7	7	160	15	13,5	15	8,5	214	1
6323840	DSV 35 B 8	8	160	15	14,0	15	8,5	212	1
6323920	DSV 35 B 9	9	200	18	16,0	17	10,5	359	1
6324060	DSV 35 B 10	10	200	18	17,5	17	10,5	367	1
6324220	DSV 35 B 12	12	200	20	22,0	21	12,5	603	1
6324300	DSV 35 B 13	13	200	22	23,5	23	12,5	695	1
6324490	DSV 35 B 14	14	200	24	26,0	25	14,5	933	1
6324730	DSV 35 B 17	17	250	28	31,0	31	17,0	1737	1
6325030	DSV 35 B 19	19	320	30	34,0	31	17,0	2186	1
6325460	DSV 35 B 22	22	320	34	39,0	36	19,0	3057	1



NUT DRIVERS WITH HANDLE

33 F

NUT DRIVER flexible

- ▶ With hanging hole
- ▶ Limited torque
- ▶ Head depth 13 mm
- ▶ Chrome-vanadium steel, chrome-plated

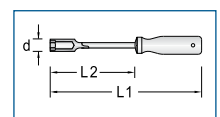
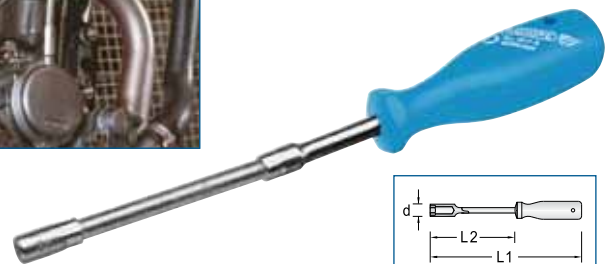

Code	No.	Ø mm	L ₁	L ₂	d	↺↻	📦
6362230	33 F 5	5	250	150	11	144	5
6360020	33 F 6	6	250	150	11	142	5
6360290	33 F 7	7	250	150	11	132	10
6360370	33 F 8	8	250	150	12	136	10
6360610	33 F 10	10	270	160	14	192	5

35 D

TOMMY BAR for 35 and V 35

- ▶ Acc. to DIN 900 Form A
- ▶ With location grooves for socket wrenches
- ▶ Fully hardened, GEDORE vanadium steel 31CrV3, manganese-phosphated



Code	No.	→mm←	Ø	↺↻	📦
6326000	35 D 6	160	6	34	1
6326190	35 D 8	180	8	69	1
6326270	35 D 10	200	10	121	1
6326350	35 D 12	250	12	218	1
6326430	35 D 14	320	14	378	1
6326510	35 D 16	400	16	621	1
6326780	35 D 18	500	18	986	1
6326860	35 D 20	630	20	1519	1



2133

NUT DRIVER WITH 3C-HANDLE

- Acc. to DIN 3125, ISO 2725-1
- With hanging hole
- Head depth 25 mm, blade length 125 mm
- Size 2.5 - 3.5 with stepped head \varnothing 5 mm
- 10 mm and larger with hexagon bolster size 13 mm
- GEDORE vanadium steel 31CrV3, matt chrome-plated
- * not standardised

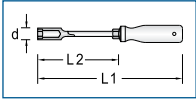
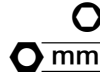

Code	No.	*	\varnothing mm	L ₁	L ₂	d	\bullet mm		
1746669	2133 2,5	*	2.5	225	125	7,0	-	83	1
1746677	2133 3		3.0	225	125	7,0	-	81	1
1746685	2133 3,2		3.2	225	125	7,0	-	82	1
1746693	2133 3,5		3.5	225	125	7,0	-	816	1
1746707	2133 4		4.0	225	125	6,9	-	82	1
1746715	2133 4,5		4.5	225	125	7,0	-	82	1
1746723	2133 5		5.0	225	125	8,0	-	83	1
1746731	2133 5,5		5.5	225	125	8,0	-	93	1
1746758	2133 6		6.0	225	125	9,0	-	95	1
1746766	2133 7		7.0	235	125	11,0	-	117	1
1746855	2133 8		8.0	235	125	12,0	-	134	1
1746863	2133 9		9.0	235	125	13,0	-	150	1
1746898	2133 10		10.0	245	125	14,0	13	178	1
1746901	2133 11		11.0	245	125	16,0	13	182	1
1746928	2133 12		12.0	245	125	17,0	13	201	1
1746944	2133 13		13.0	245	125	18,0	13	205	1
1746952	2133 14		14.0	245	125	19,7	13	211	1



Code	No.	\varnothing AF	L ₁	L ₂	d		
1746960	2133 3/16AF	3/16	225	125	7.0	91	1
1746979	2133 1/4AF	1/4	225	125	10.0	108	1
1746987	2133 9/32AF	9/32	235	125	11.0	114	1
1746995	2133 5/16AF	5/16	235	125	12.0	134	1
1747002	2133 11/32AF	11/32	235	125	13.0	146	1
1747010	2133 3/8AF	3/8	245	125	14.0	169	1
1747029	2133 7/16AF	7/16	245	125	16.0	175	1
1747037	2133 1/2AF	1/2	245	125	18.0	197	1

33 TLM

NUT DRIVER WITH T-HANDLE with magnet, long pattern

- With hanging hole
- Head depth 25 mm
- GEDORE vanadium steel 31CrV3, matt chrome-plated

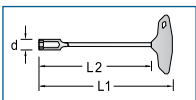

Code	No.	\varnothing mm	L ₁	L ₂	d		
6352190	33 TLM 8	8	389	350	12	188	5
6353160	33 TLM 10	10	389	350	14	262	5
6353240	33 TLM 13	13	389	350	18	271	5

33 T

NUT DRIVER WITH T-HANDLE

- With hanging hole
- Head depth 25 mm
- GEDORE vanadium steel 31CrV3, matt chrome-plated

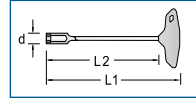

Code	No.	\varnothing mm	L ₁	L ₂	d		
1531239	33 T 2,5	2.5	180.0	160	7.0	31	5
1531247	33 T 3	3.0	180.0	160	7.0	31	5
1531255	33 T 3,2	3.2	180.0	160	7.0	31	5
1531263	33 T 3,5	3.5	227.5	195	7.0	49	5
1531271	33 T 4	4.0	227.5	195	6.9	72	5
1531298	33 T 4,5	4.5	227.5	195	7.0	71	5
1531301	33 T 5	5.0	227.5	195	8.0	73	5
6353320	33 T 5,5	5.5	227.5	195	8.0	92	5
6357580	33 T 6	6.0	227.5	195	9.0	97	5
6357660	33 T 7	7.0	227.5	195	11.0	89	10
6357740	33 T 8	8.0	269.0	230	12.0	146	10
6357820	33 T 9	9.0	269.0	230	13.0	165	5
6357900	33 T 10	10.0	269.0	230	14.0	156	10
6353400	33 T 11	11.0	269.0	230	16.0	176	5
6353590	33 T 12	12.0	269.0	230	17.0	201	5
6358040	33 T 13	13.0	269.0	230	18.0	195	10
6366060	33 T 14	14.0	269.0	230	20.0	214	5



TX 33 T

NUT DRIVER WITH T-HANDLE for protruding TORX® head screws

- From E4 to E10
- Ergonomically designed blue handle, non-slip grained surface, for higher torques
- TORX® = reg. trademark of Acument Intellectual Properties, LLC. USA

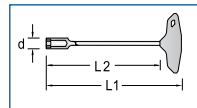
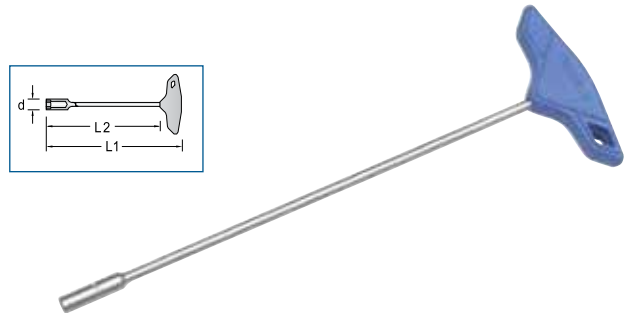

Code	No.	\varnothing		\bullet mm	L ₁	L ₂	d		
1394940	TX 33 T E4	E4	M3	3,86 x 2,88	192.5	160	7	79	5
1394967	TX 33 T E5	E5	M4	4,73 x 3,46	192.5	160	7	79	5
1394975	TX 33 T E6	E6	M5	5,74 x 4,11	234.0	195	8	81	5
1394983	TX 33 T E7	E7	M6	6,16 x 4,55	234.0	195	10	103	5
1395009	TX 33 T E8	E8	M6 - M7	7,52 x 5,4	234.0	195	11	105	5
1395017	TX 33 T E10	E10	M8	9,42 x 6,92	269.0	230	13	175	5



TUBULAR BOX SPANNERS

26 R

TUBULAR BOX SPANNER

- ▶ Acc. to DIN 896 Form B, ISO 2236, ISO 1085
- ▶ Hollow shaft, in tubular steel, DIN 2391 seamless, hardened, made from material C35, chrome-plated
- ▶ * not standardised

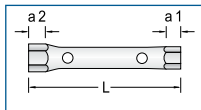

Code	No.	*	Ømm	L	a ₁	a ₂	26 D	26 RS	↕	📦
6222810	26 R 5,5x7	*	5,5 x 7	105	5,5	6,5	5	1	36	5
6210050	26 R 6x7		6 x 7	105	6,0	6,5	5	1	35	5
6210210	26 R 8x9		8 x 9	105	7,0	7,5	6	1	41	10
6210480	26 R 8x10		8 x 10	120	7,0	8,0	6	1	49	10
6210560	26 R 9x10	*	9 x 10	120	7,5	8,0	6	1	50	5
6210640	26 R 10x11		10 x 11	120	8,0	8,5	6	1	55	10
6210720	26 R 10x13		10 x 13	140	8,0	10,0	8	2	72	10
6210800	26 R 11x13		11 x 13	140	8,5	10,0	8	2	74	5
6210990	26 R 12x13		12 x 13	140	9,5	10,0	8	2	73	10
6211020	26 R 12x14		12 x 14	140	9,5	10,5	8	2	83	10
6211100	26 R 13x14	*	13 x 14	140	10,0	10,5	8	2	83	10
6211290	26 R 13x15	*	13 x 15	140	10,0	11,5	8	2	89	10
6211370	26 R 14x15		14 x 15	140	10,5	11,5	8	2	88	10
6211450	26 R 13x17		13 x 17	150	10,0	12,5	10	2	139	10
6211530	26 R 14x17		14 x 17	150	10,5	12,5	10	2	140	10
6211610	26 R 16x17		16 x 17	150	12,0	12,5	10	2	139	10
6223030	26 R 16x18		16 x 18	150	12,0	13,5	10	2	152	5
6211880	26 R 17x19		17 x 19	155	12,5	15,5	12	3	161	10
6211960	26 R 18x19		18 x 19	155	13,5	15,5	12	3	161	10
6212180	26 R 19x22		19 x 22	165	15,5	16,5	12	3	261	10
6212260	26 R 20x22		20 x 22	165	16,0	16,5	12	3	264	10
6212340	26 R 21x23		21 x 23	165	16,0	18,0	14	3	291	10
6212420	26 R 22x24		22 x 24	180	17,0	20,0	14	3	291	10
6212500	26 R 24x26		24 x 26	180	20,0	22,0	14	3	314	10
6212690	26 R 24x27		24 x 27	180	20,0	22,0	14	3	319	10
6212770	26 R 25x28		25 x 28	195	20,0	22,0	16	3	365	10
6212850	26 R 27x30		27 x 30	195	22,0	23,0	16	3	386	10
6212930	26 R 27x32		27 x 32	195	22,0	27,0	16	3	415	10
6213070	26 R 30x32		30 x 32	195	23,0	27,0	16	3	409	10
6213150	26 R 30x36		30 x 36	215	23,0	28,0	18	-	528	1
6213230	26 R 32x36		32 x 36	215	27,0	28,0	18	-	535	1
6213310	26 R 36x41		36 x 41	215	28,0	31,0	18	-	678	1
6213580	26 R 41x46		41 x 46	235	31,0	35,0	20	-	823	1
6213660	26 R 46x50		46 x 50	235	35,0	37,0	20	-	869	1
6213740	26 R 50x55		50 x 55	235	37,0	40,0	20	-	1126	1

26 D

TOMMY BAR

- ▶ Acc. to DIN 900 Form A
- ▶ GEDORE vanadium steel 31CrV3, chrome-plated up to 20 mm Ø, manganese-phosphated up from 25 mm Ø, fully hardened



Code	No.	↳mm↳	Ø	↕	📦
6208310	26 D 5	125	5	21	5
6208580	26 D 6	160	6	40	5
6208740	26 D 8	180	8	73	5
6208820	26 D 10	200	10	127	5
6208900	26 D 12	250	12	228	5
6209040	26 D 14	320	14	386	1
6209120	26 D 16	400	16	634	1
6209200	26 D 18	500	18	995	1
6209390	26 D 20	630	20	1555	1
6209470	26 D 25	710	25	2680	1
6209550	26 D 32	800	32	5015	1
6209630	26 D 40	1000	40	9685	1

KD 26 R

TUBULAR BOX SPANNER SET with tommy bars

- ▶ Hollow shaft, in tubular steel, DIN 2391 seamless, hardened, made from material C35, chrome-plated

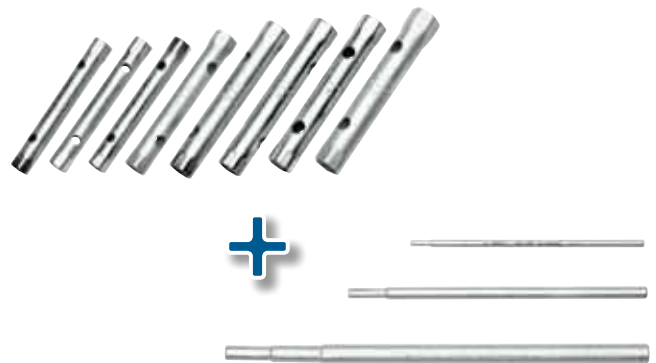

Code	No.	Contents	↕	📦
6218540	KD 26 R-8	26 R 6x7 8x9 10x11 12x13 14x15 16x17 18x19 20x22 26 RS 1 2 3	1564	1
6218890	KD 26 R-120	26 R 6x7 8x9 10x11 12x13 14x15 16x17 18x19 20x22 21x23 24x27 25x28 30x32 26 RS 1 2 3	2895	1

www.gedore.com

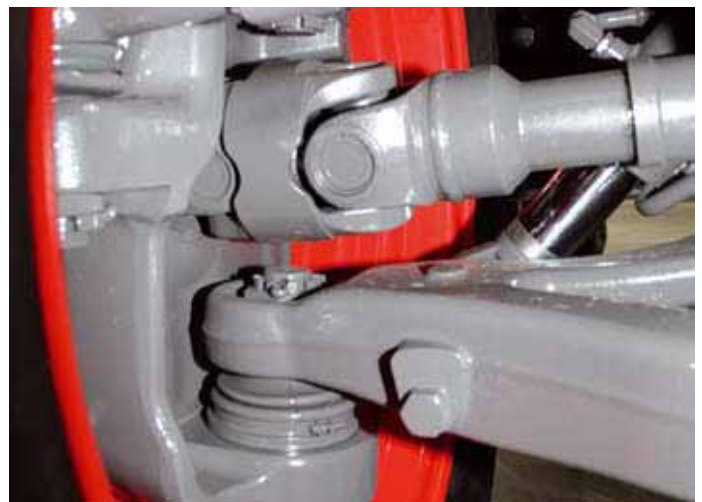



626

TUBULAR BOX SPANNER heavy-duty pattern

- Similar to DIN 896, Form A, ISO 2236, ISO 1085
- With hexagon shaft and holes for turning, either with a spanner or a tommy bar (626 S / 26 RS-626 S)
- Sizes 6x7 and 8x9 with no hole
- GEDORE vanadium steel 31CrV3, chrome-plated, polished heads

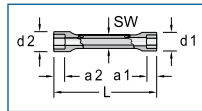

Code	No.	Ø mm	L	a ₁	a ₂	d ₁	d ₂	● mm	26 RS-626 S	↕	📦
6525120	626 6x7	6 x 7	105	6.0	7.0	9.5	10.5	8	626 S 1	375	10
6525200	626 8x9	8 x 9	110	7.0	8.0	12.0	13.0	9	626 S 1	52	10
6525390	626 10x11	10 x 11	120	9.0	9.5	14.5	16.0	11	626 S 1	72	10
6525470	626 12x13	12 x 13	140	10.5	11.0	17.0	18.5	13	626 S 1	117	10
6525710	626 14x15	14 x 15	145	11.5	13.0	19.5	21.0	14	626 S 1	145	10
6520160	626 13x16	13 x 16	145	11.0	13.0	18.5	22.0	15	626 S 2	144	5
6520750	626 13x17	13 x 17	155	11.0	14.0	18.5	23.0	15	626 S 2	160	5
6526280	626 16x17	16 x 17	155	13.0	14.0	22.0	23.0	16	626 S 2	189	10
6520240	626 16x18	16 x 18	160	13.0	15.0	22.0	24.5	18	626 S 2	206	1
6526360	626 17x19	17 x 19	165	14.0	17.5	23.0	26.0	18	626 S 2	233	5
6526440	626 18x19	18 x 19	165	15.0	17.5	24.5	26.0	18	626 S 2	242	5
6520320	626 18x21	18 x 21	170	15.0	17.5	24.5	28.5	19	626 S 2	246	1
6526520	626 19x22	19 x 22	175	17.5	18.5	26.0	30.0	19	626 S 2	288	5
6526600	626 20x22	20 x 22	175	17.5	18.5	27.5	30.0	19	626 S 2	306	5
6526790	626 21x23	21 x 23	185	17.5	19.5	28.5	31.0	21	626 S 2	358	1
6520400	626 21x24	21 x 24	185	17.5	21.5	28.5	32.5	24	26 RS-626 S-3	361	1
6526870	626 24x26	24 x 26	195	21.5	23.5	32.5	34.5	24	26 RS-626 S-3	452	1
6526950	626 24x27	24 x 27	195	21.5	23.5	32.5	36.0	24	26 RS-626 S-3	493	5
6527090	626 25x28	25 x 28	205	21.5	23.5	33.5	37.0	27	26 RS-626 S-3	577	1
6527170	626 30x32	30 x 32	210	25.0	29.0	39.5	42.5	30	26 RS-626 S-3	725	5
6520590	626 30x34	30 x 34	220	25.0	29.0	39.5	46.0	30	26 RS-626 S-3	770	1
6527250	626 32x36	32 x 36	225	29.0	30.5	42.5	48.0	32	26 RS-626 S-3	898	1
6520670	626 34x36	34 x 36	235	29.0	30.5	46.0	48.0	32	26 RS-626 S-3	988	1

KD 626

TUBULAR BOX SPANNER SET with tommy bars

- Similar to DIN 896, Form A, ISO 2236, ISO 1085
- With hexagon shaft and holes for turning, either with a spanner or a tommy bar (626 S / 26 RS-626 S)
- Sizes 6x7 and 8x9 with no hole
- GEDORE vanadium steel 31CrV3, chrome-plated, polished heads



Code	No.	Contents	↕	📦
6528650	KD 626-7	626 8x9 10x11 12x13 14x15 16x17 18x19 20x22 626 S 1 2	1378	1
6528730	KD 626-8	626 6x7 8x9 10x11 12x13 14x15 16x17 18x19 20x22 626 S 1 2	1434	1
6528810	KD 626-120	626 6x7 8x9 10x11 12x13 14x15 16x17 18x19 20x22 21x23 24x27 25x28 30x32 626 S 1 2 3	4065	1

26 RS

STEPPED TOMMY BAR

- GEDORE vanadium steel 31CrV3, chrome-plated, fully hardened



Code	No.	↳mm↳	Ø ₁	Ø ₂	Ø ₃	↕	📦
6219350	26 RS 1	190	5,0	6,0	Ø ₃	45	5
6219430	26 RS 2	240	8,0	10,0		149	5
6528220	26 RS-626 S-3	310	11,7	13,7	16,0	492	5

626 S

STEPPED TOMMY BAR

- GEDORE vanadium steel 31CrV3, chrome-plated, fully hardened



Code	No.	↳mm↳	Ø ₁	Ø ₂	Ø ₃	Ø ₄	Ø ₅	↕	📦
6528060	626 S 1	190	3,7	4,7	5,2	7,0		50	5
6528140	626 S 2	240	6,7	7,7	8,7	9,7	11,0	159	5
6528220	26 RS-626 S-3	310	11,7	13,7	16,0			492	5

www.gedore.com





MULTI FITTING KEYS

45 P

PROFI-KEY UNIVERSAL

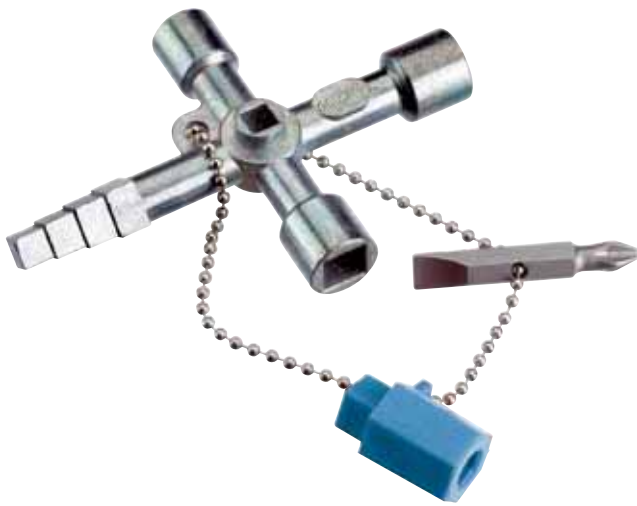
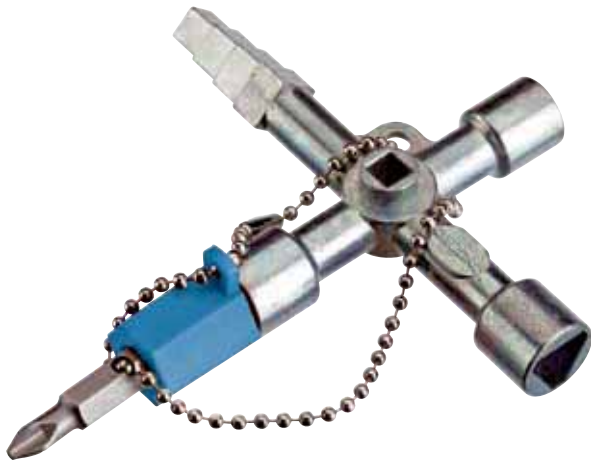
- ✔ Key for opening and closing of technical shut-off systems e.g. air-conditioning, revision systems
- ✔ For the outdoor areas - locking of bins or waste containers, and street lamp lids etc.
- ✔ With bit insert: slotted head 1.0 x 7 mm and cross-slotted head PH 2 with adapter for 1/4" bits on securing chain
- ✔ 5 mm square for radiator valves
- ✔ Stepped key with 6, 7, 8, 9 mm square
- ✔ Female square 5, 6, 7-8 mm
- ✔ Female three-square 9 mm
- ✔ Dimensions: 90 x 62 mm
- ✔ Zinc die-casting



Code	No.		
2190117	45 P	80	1



45 S

MULTI FITTING MASTER KEY UNIT

- ✔ Key for opening and closing of master cabinets, switch panels, technical shut-off systems e.g. air-conditioning, revision systems
- ✔ For the outdoor areas - locking of bins or waste containers, and street lamp lids etc.
- ✔ Supplied with bit insert: slotted head 1.0 x 7 mm and cross-slotted head PH 2 with adapter for 1/4" bits on securing chain
- ✔ 5 mm square for radiator valves
- ✔ Female square 5, 6, 7-8 mm
- ✔ Female three-square 9 mm
- ✔ Two-way-key 3-5 mm
- ✔ Dimensions: 72 x 72 mm
- ✔ Zinc die-casting



Code	No.		
2190125	45 S	80	1

www.gedore.com



VDE 1988 / VDE 1989 T



505

**45 U****MULTI FITTING KEY UNIVERSAL**

- ▶ For all usual technical shut-off systems
- ▶ 1 tool for 9 applications
- ▶ 8 different master cabinet shut-off systems and 5 mm square for radiator valves
- ▶ Flat construction due to space-saving swivel mechanism
- ▶ Square locking: 5, 6, 7-8, 9-10 mm
- ▶ Three-edged locking: 7, 8-9, 10-11 mm
- ▶ Two-way-key 3-5 mm and half-moon locking 6 mm
- ▶ Securing chain with snap-hook
- ▶ Dimensions: 95 x 95 mm
- ▶ Zinc die-casting



Code	No.		
2294826	45 U	204	1

45 B**MULTI FITTING KEY CONSTRUCTION**

- ▶ Especially suitable for the construction sector
- ▶ Space-saving, double swivel mechanism
- ▶ Stepped key with 6, 7, 8, 9 mm square
- ▶ Female square 5, 8 mm
- ▶ Female three-square 9 mm
- ▶ Magnetic bit adaptor 1/4", supplied with one bit PH 2
- ▶ Screwdriver function with retaining clip
- ▶ Length: 145 mm

**45 E****MULTI FITTING KEY ELECTRO**

- ▶ For all usual electric master cabinets
- ▶ Space-saving, double swivel mechanism
- ▶ 5 mm square for radiator valves
- ▶ Female square 5, 6, 7-8 mm
- ▶ Female three-square 9 mm
- ▶ Two-way-key 3 - 5 mm
- ▶ Magnetic bit adaptor 1/4", supplied with one bit PH 2
- ▶ Screwdriver function with retaining clip
- ▶ Length: 145 mm



Code	No.		
2294796	45 E	120	1



Code	No.		
2294818	45 B	120	1



HOOK SPANNERS

40

HOOK WRENCH with lug

- ▲ Acc. to DIN 1810, Form A
- ▲ For slotted round nuts according to DIN 981
- ▲ GEDORE vanadium steel 31CrV3, manganese-phosphated



Code	No.	mm	L	b	n	t ₁	↺↻	📦
6333990	40 16-20	16-20	110	2.0	3.8	1.5	26	10
6334020	40 25-28	25-28	135	2.5	4.5	2.0	38	10
6334100	40 30-32	30-32	135	2.5	4.5	2.0	43	10
6334290	40 34-36	34-36	170	3.0	5.5	2.5	71	10
6334370	40 40-42	40-42	170	3.0	5.5	2.5	78	10
6334450	40 45-50	45-50	205	3.5	6.5	3.0	133	10
6334530	40 52-55	52-55	205	3.5	6.5	3.0	130	10
6334610	40 58-62	58-62	240	4.0	7.5	3.5	196	10
6334880	40 68-75	68-75	240	4.0	7.5	3.5	208	10
6334960	40 80-90	80-90	280	5.0	8.5	4.0	282	10
6335180	40 95-100	95-100	280	5.0	8.5	4.0	275	1
6335260	40 110-115	110-115	335	5.0	10.3	4.0	491	1
6335340	40 120-130	120-130	335	5.0	10.3	4.0	493	1
6335420	40 135-145	135-145	385	6.0	12.3	5.0	841	1
6335500	40 155-165	155-165	385	6.0	12.3	5.0	820	1
6335690	40 180-195	180-195	465	6.0	14.3	5.0	1445	1
6335770	40 205-220	205-220	465	6.0	14.3	5.0	1448	1

40 Z

HOOK WRENCH with pin

- ▲ Acc. to DIN 1810, Form B
- ▲ For cross-drilled nuts according to DIN 1816
- ▲ GEDORE vanadium steel 31CrV3, manganese-phosphated



Code	No.	mm	L	d	n	t ₂	↺↻	📦
6335850	40 Z 16-18	16-18	110	2.5	3.8	2.5	14	5
6335930	40 Z 20-22	20-22	110	2.5	3.8	2.5	14	5
6336580	40 Z 25-28	25-28	135	3.0	4.5	3.0	39	5
6336660	40 Z 30-32	30-32	135	4.0	4.5	3.0	45	10
6336740	40 Z 34-36	34-36	170	4.0	5.5	3.5	80	10
6336820	40 Z 40-42	40-42	170	4.0	5.5	3.5	79	10
6336900	40 Z 45-50	45-50	205	5.0	6.5	4.0	136	10
6337040	40 Z 52-55	52-55	205	5.0	6.5	4.0	129	10
6337120	40 Z 58-62	58-62	240	5.0	7.5	5.0	198	10
6337200	40 Z 68-75	68-75	240	6.0	7.5	5.0	198	10
6337390	40 Z 80-90	80-90	280	6.0	8.5	6.0	281	10
6337470	40 Z 95-100	95-100	280	8.0	8.5	6.0	276	1
6337550	40 Z 110-115	110-115	335	8.0	10.3	8.0	494	1
6337630	40 Z 120-130	120-130	335	8.0	10.3	8.0	492	1
6337710	40 Z 135-145	135-145	385	8.0	12.3	8.0	829	1
6337980	40 Z 155-165	155-165	385	8.0	12.3	8.0	841	1
6338010	40 Z 180-195	180-195	465	10.0	14.3	8.0	1420	1
6338280	40 Z 205-220	205-220	465	10.0	14.3	8.0	1402	1

44

CALIPER FACE SPANNER adjustable

- ▲ Similar to DIN 3116
- ▲ Special sizes on request
- ▲ GEDORE vanadium steel 31CrV3, manganese-phosphated

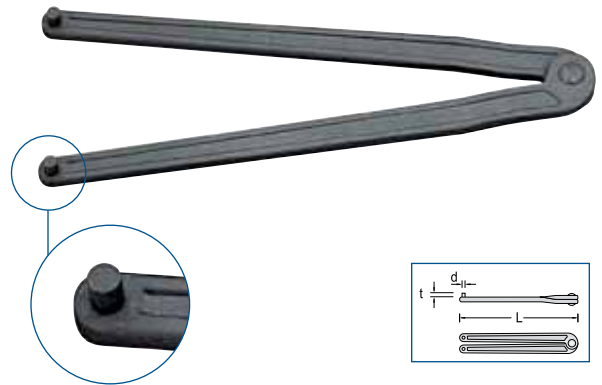

Code	No.	mm	L	L'	d	t	↺↻	📦
6354480	44 3	3	178	7	2.9	4	148	10
6354560	44 4	4	178	7	3.8	5	151	10
6354640	44 5	5	230	9	4.8	6	259	10
6354720	44 6	6	230	9	5.8	7	26	10
6354990	44 8	8	230	9	7.8	8	265	10

Special manufacture

- ▲ As a group that manufactures hand tools and industrial equipment, we aim to solve your tool problems!
- ▲ Our Technical Field Service will work with you to find solutions.
- ▲ Customised products are in good hands with us.
- ▲ In-house design, tooling construction and manufacture ensure smooth order handling - Everything from a single source!

(Examples for special manufactures)

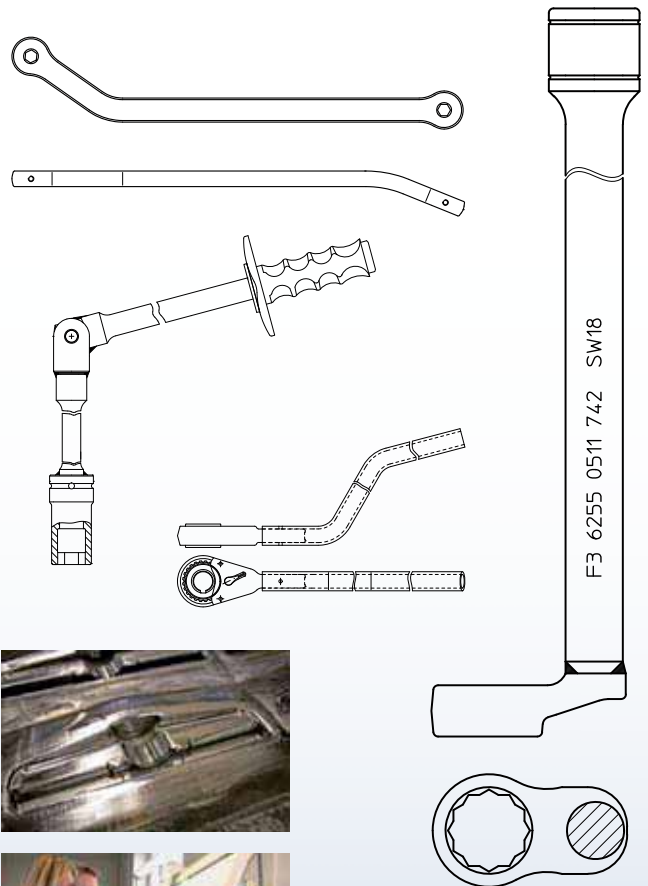

**PRACTICAL HELPERS****636****PLUS-FORM HANDLE**

- Push-on handle for spanners
- Designed for use with No. 4, 6, 7, 894, 895 sizes 13 - 22 mm
- Where high hand force is needed to turn the spanner, the ergonomic Plus-Form handle distributes the force evenly over the hand
- This avoids painful pressure points in the palm
- The special design of the holder and counter-holder safely secures the spanner in the handle
- Ideal for removing tight bolts
- The Plus-form handle extends short spanners, increasing the applied force!
- Practical hanging hole
- Made from scratch-proof, sky-blue powder-coated sheet steel



Code	No.	↕	📦
1999079	636	100	1

637**RETAINING CLIP FOR NUTS**

- With magnetic holder
- Suitable for open ended and flat ring spanners size 10-19 mm



Code	No.	↕	📦
1834150	637	6	1

639**COMBINATION HOLDING TOOL**

- Small helper to hold nuts and washers in barely accessible places
- For thread sizes from M3 to M8

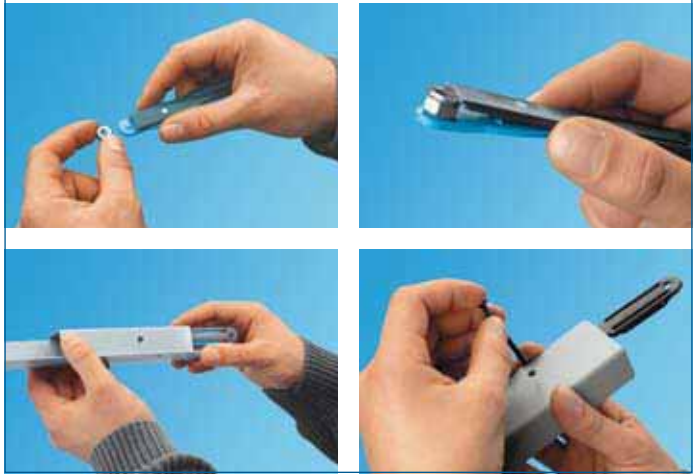

Code	No.	L	W	H	↕	📦
1640852	639	110	19.2	9.7	16	1

**649****MINIATURE LED LAMP with swivel end in plastic box**

- With swivel end, magnetic
- Supplied with batteries in black plastic box, 106 x 60 x 24 mm



Code	No.	↕	📦
1646451	649	71	1





270 +3

224

221

0 100001-1-20
GEORGE GERMAN

GEORGE



++ DESIGN FOR UNIVERSAL USE +



SERVICE / FEATURES

144 - 149

6.3 (1/4") SQUARE DRIVE

6.3 1/4 6.3 1/4



150 - 163



10 (3/8") SQUARE DRIVE

10 3/8 10 3/8



164 - 177

12.5 (1/2") SQUARE DRIVE

12.5 1/2 12.5 1/2

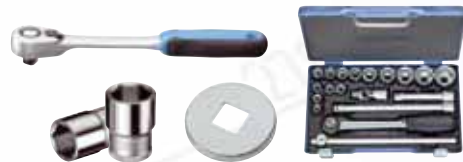

178 - 199

20 (3/4") SQUARE DRIVE

20 3/4 20 3/4



200 - 205

25 (1") SQUARE DRIVE

25 1 25 1



206 - 208

FRICITION TYPE RATCHETS



209 - 210

IMPACT TOOLS



211 - 219

BIT RANGE



220 - 229



GEDORE "POWERFUL RATCHETS AND STURDY SOCKETS"

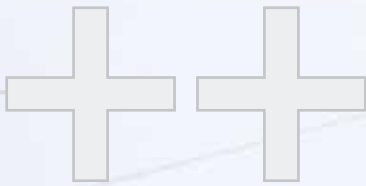

A HUGE VARIETY OF TYPES

- Intelligently designed ratchets meet every demand placed and more besides.
- Sturdy, fine-toothed, durable and extremely resilient
- Top-grade industrial quality for the hardest of continuous uses
- Unrivalled diversity of wrench sockets, metric, inch, TORX®, multi-tooth, internal hexagon or slot and cruciform
- Screw head protecting profiles (UD bi-hexagonal and hexagonal)

+ QUALITY FROM A - Z...

- + Use of the best-possible raw materials, most up-to-date machinery and environmentally-friendly production processes
- + Our tool specialists vouch for exactness in processing and continuous refinements
- + Unique manufacturing processes and special tool treatment bring about the best in results
- + Stringent quality checks after each production step ensure a constantly high level



- + Customised manufacturing on request

MAXIMUM QUALITY SOCKET SETS...

- Are blue-hammer finished and from GEDORE
- Maximum resilience of the sockets and robustness of the drive parts have turned "GEDORE sockets sets" into a household name internationally
- A name known on the tool market for many years now
- The sturdy and secure way to keep and carry your tools

+ FROM PRECISION MECHANICS TO HEAVY INDUSTRY...

- GEDORE operating tools and accessories for professional tool use in each and every industry
- For heavy continuous use and safety in everyday work
- Available individually or in practical set compilations, in the module or in sets



PRO GEDORE

- Use of high alloy 31CrV3 steel
- Heat formed sockets which have a wear resistant, fine-grained structure and have a long service life
- Narrow production tolerances ensure an ideal load transmission and low wear and guarantee a long service life
- Distinctive ball catch ensure secure fit on the square drive
- Good grip due to deep knurling even when held with oily hands or when working with protective gloves
- Good look due to chrome plating and varnishing
- Broad range in all sizes, drive and drive-side and for a wide range of screw types. One of the most diverse ranges in the market.

(*) Not applicable to 1/4" hexagonal sockets





THE GEDORE SOCKET SET



- ▶ Innovative, functional design
- ▶ Sheet steel case - inside-folded, seamless edge provides added strength. The tool and foam inserts are secured to prevent them being lost
- ▶ ABS plastic tool insert, resistant to oils and greases
- ▶ Tool insert with the socket sizes permanently laser marked
- ▶ With the lid closed, the tools sit securely in their pockets
- ▶ Boxes designed so that they can be stacked easily
- ▶ Large, rounded fasteners can be opened and closed even when the user is wearing gloves
- ▶ Contoured carry handle ensures comfortable carrying even for long periods
- ▶ Environmentally-friendly powder-coated in GEDORIT blue



SOCKETS

- ▶ The range includes an unparalleled variety of sockets to meet all industrial and professional requirements, including the socket with the snug fitting UNIT-Drive profile.



1335 · 1440

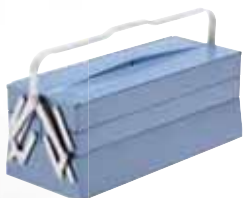

48
50

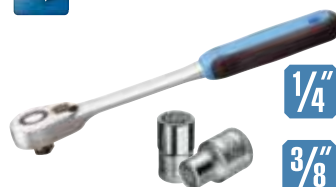

1/4"

3/8"



150
163

164
177



1/2"

3/4"

1"

178
199
200
205
206
208



+ RATCHET + +



U-20 RATCHETS
DESIGN-ORIENTED PREMIUM RATCHETS



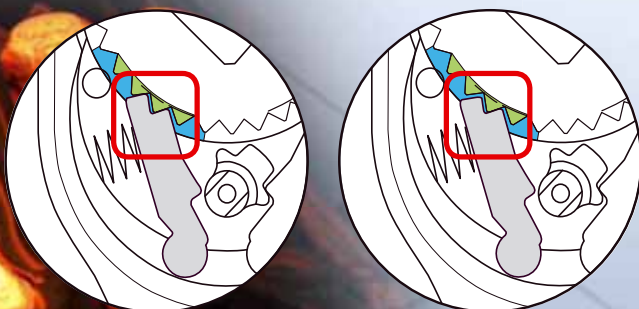

6,3 1/4" 10 3/8" 12,5 1/2"

- Easy change lever for clockwise and anti-clockwise movement.
- Slim, ergonomic design
- The release head simplifies attachment and removal of sockets. A ball locking device ensures a tight connection when the ratchet is in use.
- The shaft is made from high-grade chrome-vanadium steel, making it ideal for heavy and constant use.
- 2-component handle, comprising a hard plastic core with rubber sheathing for heavy industrial use. Hanging hole for easy-to-find storage.



RATCHETS

- The properties of our hot-forged spanners also apply to our hot-forged ratchets.
- A special feature of GEDORE ratchets is their mechanism, in which the pawl does not fully engage in the ratchet until full loading is reached. This process is invisible to the naked eye. The movement of the mechanism is in the infinitesimal range, amounting to just a few hundredths of a millimetre. The perfect centred running of the ratchet under load achieved by this design is a significant quality and safety feature of our ratchets. There is no unnecessary stressing of the individual elements when the ratchet is turning with no load, and no possibility of the mechanism tilting under load. This ensures fault-free under-load operation for the life of the ratchet. The design also has a positive effect on working safety. Tooth jumping, that would lead to jerky movement, is completely eliminated, minimizing the risk of accidents. This applies equally to GEDORE lever-activated ratchets and all other GEDORE ratchets.

	Type of ratchet / drive	6.3 $\frac{1}{4}$ "	10 $\frac{3}{8}$ "	12.5 $\frac{1}{2}$ "	20 $\frac{3}{4}$ "	25 1"	Friction-type ratchet	Mode of operation	
Reversible ratchets									
	Reversible ratchet with push-button release and lever change	2093 U-20 	3093 U-20 	1993 U-20 					Use throughout industry and the automotive world - and well as in confined spaces.
	Reversible ratchet with control lever with centre locking	2093 U-10 	3093 U-10 		3293 U-10 	2193 U-10 			Particularly for the demanding use experienced in industry and with utility vehicles.
	Reversible ratchet with push-button release and lever change with centre locking			1993 U-10 T 					Particularly for the demanding use experienced in industry and with utility vehicles.
	Reversible ratchet with push-button release and lever change with centre locking			1993 U-10 L 					For an increase in torque. Long design
	Aluminium reversible ratchet with push-button release and lever change with centre locking		3093 ALU-10 	1993 ALU-10 					Very lightweight. Especially for work done above your head.
	Reversible ratchet with metal disc change	2093 U-3 	3093 U-3 	1993 U-3 	3293 U-3 	2193 U-3 			Especially for working in confined spaces. As in the automotive business
	Reversible ratchet with metal disc change				3293 U-2 				Especially for working in confined spaces.
	Swivel-head reversible ratchet with metal disc change		3093 GU-3 	1993 GU-3 					Especially for use in the automotive sector. Extra long design
	Swivel-head reversible ratchet with metal disc change, push-button release and lever change			1993 GU-10XL 					For an increase in torque. Especially for the utility vehicles sector.
	Ratchet handle with square coupler	2093 Z-94 	3093 Z-94 	1993 Z-94 	3293 Z-94 	2193 Z-94 			Use throughout industry and the automotive world.
	Friction-type ratchet						31 KR 31 KVR 29, 31 K 41V-418V		Especially in steel construction and scaffolding
	Hand ratchet	2093 HR-94 							For progressing fast in confined spaces.
	T-handle ratchet	2093 U-3T 	3093 U-3T 						For progressing fast in confined spaces.
	Plastic ratchet		3093 U-10K 	1993 U-10K 					For fast, smooth tightening of bolted connection up to max. 70 N-m.



i NC COROSTOP WEATHER RESISTENT RATCHETS



492
-
493

i VDE RATCHETS



505



MANUFACTURING

+ PROCESS FOR SOCKETS



Like all hot-forged tools, GEDORE sockets (*) are characterised by their homogeneous structure. The fibres run in parallel with the contour of the tool. The uninterrupted fibre orientation prevents residual stresses in the structure. In cold-forged tools, the fibres or lines of stress may deviate. Fibre orientation is equally important in nature. For example, in a tree, the soft fibre orientation is parallel to the branch, so the wood is resistant to bending and twisting. If fibres become kinked, the branch loses its stability at the kink point and breaks. The low-stress GEDORE sockets withstand suddenly occurring peak forces better than cold formed sockets.



(*) Not applicable to 1/4" hexagonal sockets

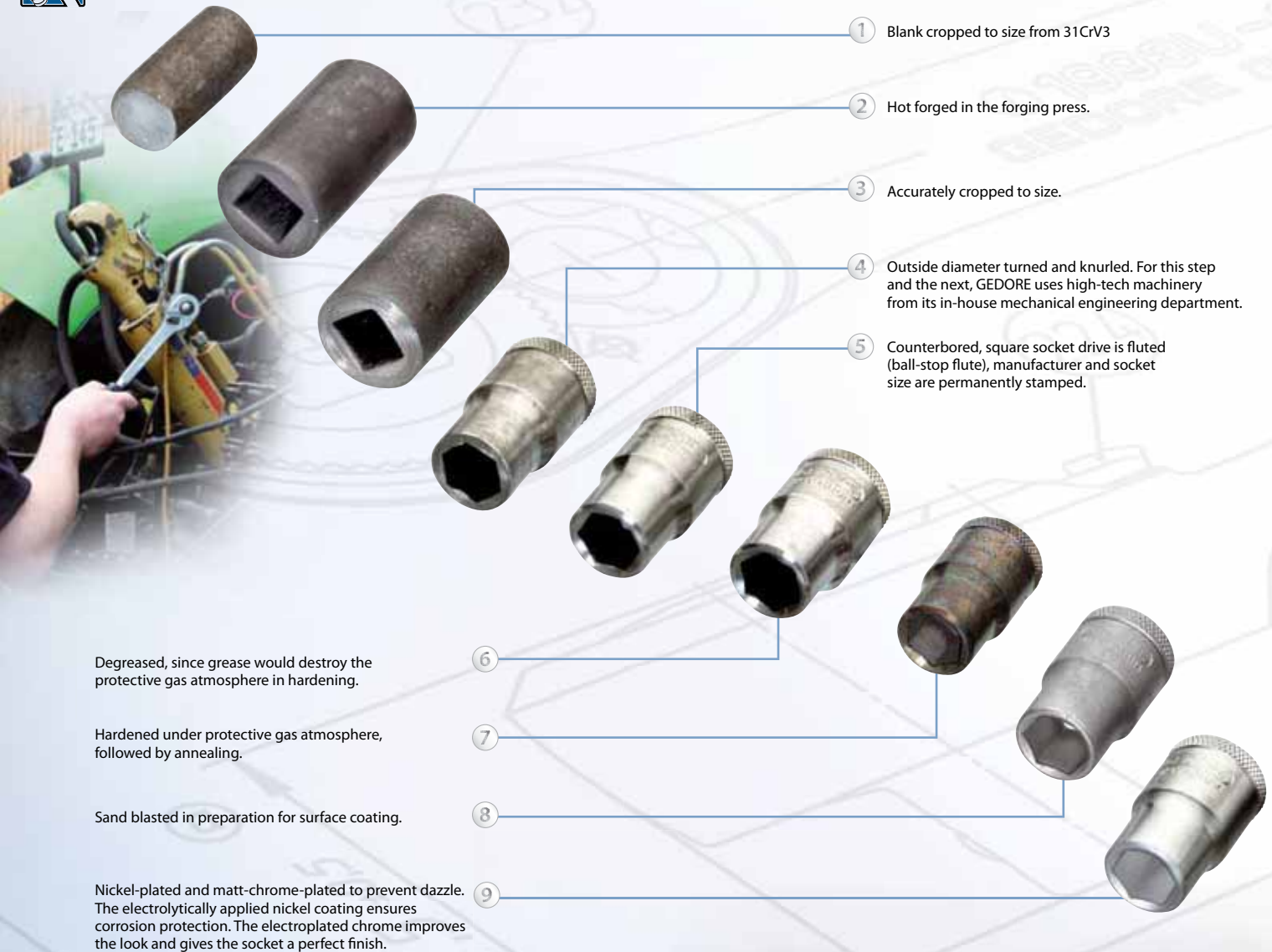

Degreased, since grease would destroy the protective gas atmosphere in hardening.

Hardened under protective gas atmosphere, followed by annealing.

Sand blasted in preparation for surface coating.

Nickel-plated and matt-chrome-plated to prevent dazzle. The electrolytically applied nickel coating ensures corrosion protection. The electroplated chrome improves the look and gives the socket a perfect finish.

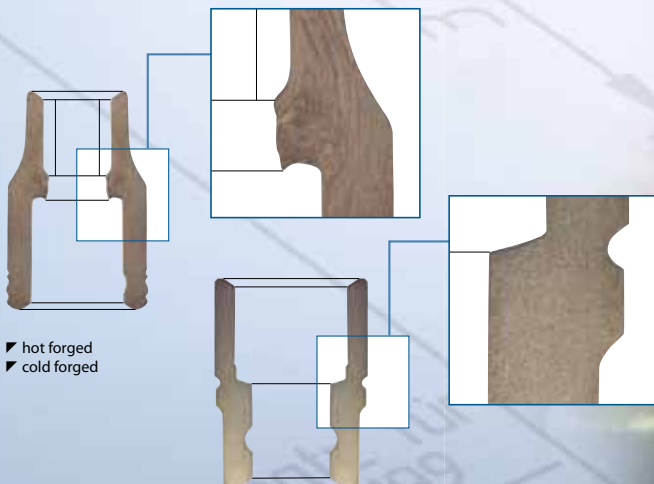



GEDORE UNIT DRIVE PROFILE

E-OPTIMUM FORCE CLOSURE PROTECTS SCREW HEADS ++



The GEDORE UNIT DRIVE profile stops screw heads from "turning round and round" by means of a wave form without any tipped or sharp edges. Enlarged, round contact surfaces of the GEDORE tools ensure that torque is reliably transferred -

acting uniformly, as it does, on the screw head. The resulting minimized notching effect prevents any damage to the screw head profile. This represents added safety since - even with damaged screw heads - there is no slipping or turning.



GEDORE UNIT DRIVE PROFILE

bi-hexagon

1 A large contact surface provides a secure force closure even for those screw heads whose sizes lie outside of the tolerances.

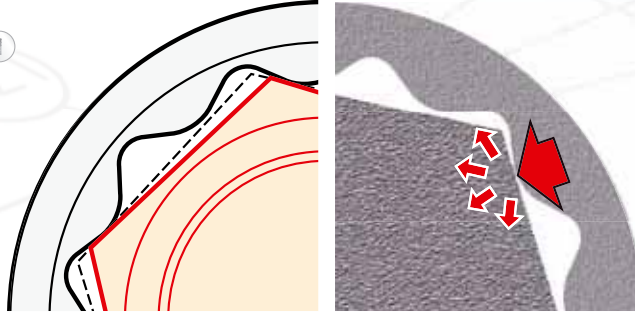

2 Uniform distribution of the force on the screw head flanks. The resulting reduced notching effect stops the screw head from turning round and round.

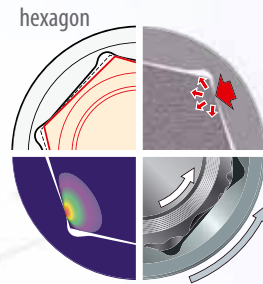

4 Gentle torque transfer enables even worn screw heads to be unscrewed with every certainty - no slipping of the tool at all.

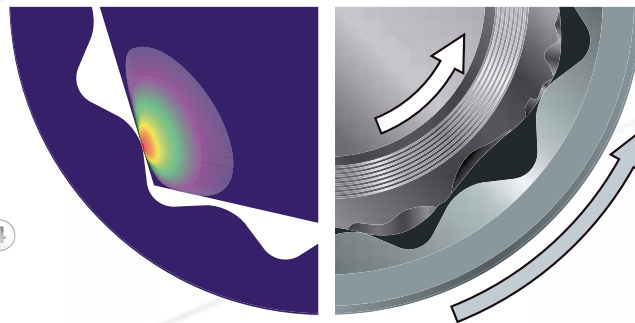

3 Thanks to the optimally distributed force up to 20% higher torques can be transferred.

Traditional profile

bi-hexagon

1 The reduced contact surface lessens the force closure. Certain torque transfer is no longer possible and can become a risk.

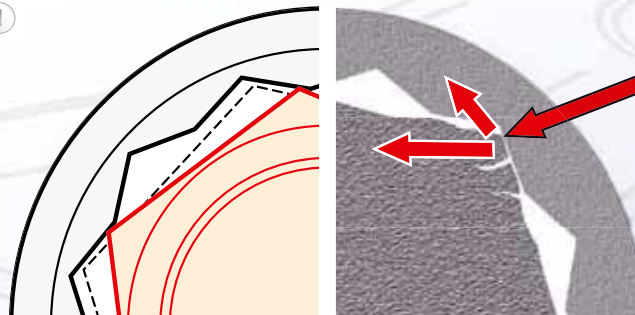

2 The influence exerted of the sharp edges raises the notching effect on the screw head. The profile is ruined.

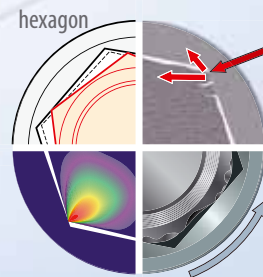

4 Since there is no longer any torque transfer, the rounded screw head profiles cannot be unscrewed - the tool keeps on slipping.

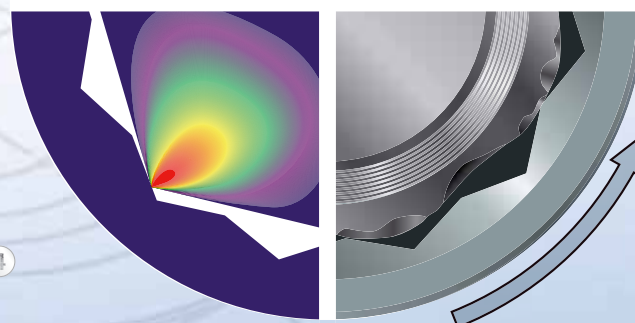

3 Pronounced force on the tip of the screw head profile. Concentrated pressure deforms the screw head.

6.3 MM (1/4") SQUARE DRIVE

6.3 1/4" 6.3 1/4"

www.gedore.com

RATCHETS 6.3 MM (1/4")

2093 U-20

REVERSIBLE RATCHET 1/4"

- Acc. to DIN 3122, ISO 3315
- Small, drop shaped head for confined areas
- Fine-toothed, with lever change and push-button release
- Non-slip 2-component handle with hanging hole
- For hand-operated sockets and accessories with square drive as per DIN 3120 - C 6.3, ISO 1174, ball locking device
- GEDORE vanadium steel 31CrV3, chrome-plated

6.3
1/4"



1/4"

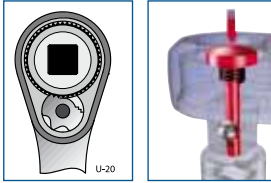

Code	No.	□"	■	∠°	↳mm↳	↳	↳	↳
1703749	2093 U-20	1/4	6.3	9	127	20	95	1

2093 U-10

REVERSIBLE RATCHET 1/4"

- Acc. to DIN 3122, ISO 3315
- With lever change, locks in middle position
- For hand-operated sockets and accessories with square drive as per DIN 3120 - C 6.3, ISO 1174, ball locking device
- GEDORE vanadium steel 31CrV3, chrome-plated

6.3
1/4"



Code	No.	□"	■	∠°	↳mm↳	↳	↳	↳
6180470	2093 U-10	1/4	6.3	15	129	21.5	109	5

2093 U-3

REVERSIBLE RATCHET 1/4"

- Acc. to DIN 3122, ISO 3315
- With non-slip metal disc change, fine-toothed and robust
- For hand-operated sockets and accessories with square drive as per DIN 3120 - C 6.3, ISO 1174, ball locking device
- GEDORE vanadium steel 31CrV3, chrome-plated

6.3
1/4"

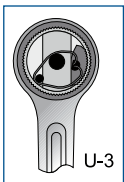

Code	No.	□"	■	∠°	↳mm↳	↳	↳	↳
6170590	2093 U-3	1/4	6.3	5	129	25	95	5

2093 Z-94

RATCHET HANDLE WITH COUPLER 1/4"

- Acc. to DIN 3122, ISO 3315
- With square coupler, medium-fine toothed, extremely rugged
- For hand-operated sockets and accessories with square drive as per DIN 3120 - C 6.3, ISO 1174 ball locking device
- GEDORE vanadium steel 31CrV3, chrome-plated

6.3
1/4"

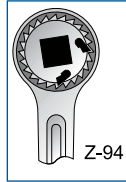

1/4"

Code	No.	1/4"	6.3	18	129	12	76	5
6170750	2093 Z-94	1/4	6.3	18	129	12	76	5

2093 U-3 T

RATCHET WITH T-HANDLE 1/4"

- Two-wing T-handle
- Ergonomic design for comfortable working
- For hand-operated sockets and accessories with square drive as per DIN 3120 - C 6.3, ISO 1174, ball locking device
- The danger of the tool canting, when carrying out work with extensions, is reduced by the central positioning of the square drive

6.3
1/4"



Code	No.	1/4"	6.3	5	140	65	1
1791532	2093 U-3 T	1/4	6.3	5	140	65	1

2093 HR-94

HAND RATCHET 1/4" without handle

- With square coupler
- Facilitates working quickly in confined spaces where other ratchets or tools do not fit
- Especially suitable for servicing work in conjunction with extension 2090-12
- Dimensions: Ø 26 x 20 mm

6.3
1/4"



Code	No.	1/4"	6.3	18	35	1
6069870	2093 HR-94	1/4	6.3	18	35	1

D 20 KMU-20



159

TIN 680 • 680



222
223











































20 XLU-3 T



160

SOCKETS 6.3 MM (1/4")



1/4"	UNIT DRIVE hexagon 	UNIT DRIVE hexagon 	UNIT DRIVE hexagon AF	UNIT DRIVE hexagon AF	UNIT DRIVE hexagon 	Hexagon - external 	Hexagon - external AF	Hexagon - external 	Internal hexagon 	Internal TORX®	Internal TORX® with pin	External TORX®	Internal serrations XZN	Slot	Cruciform PH	Cruciform PZ	Internal TORX PLUS®	Internal TORX® with ball end	Internal hexagon with ball end	Internal hexagon AF	
																					
																					

20

SOCKET 1/4" hexagon

- ▲ Acc. to DIN 3124, ISO 2725-1
- ▲ Square drive as per DIN 3120 - C 6.3, ISO 1174, with ball retaining groove
- ▲ Hand-operated, knurled grip
- ▲ GEDORE vanadium steel 31CrV3, polished, chrome-plated

6.3

1/4"

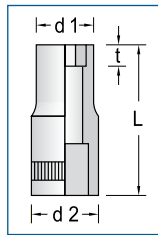

 **mm**

 **AF**

Code	No.	mm	L	d ₁	d ₂	t	90°	10°
6165400	20 4	4.0	25.0	6.9	12.0	2.0	9	10
6165590	20 4,5	4.5	25.0	7.5	12.0	2.3	10	5
6165670	20 5	5.0	25.0	8.2	12.0	2.5	10	10
6165750	20 5,5	5.5	25.0	8.8	12.0	3.0	10	10
6165830	20 6	6.0	25.0	9.4	12.0	3.5	10	10
6165910	20 7	7.0	25.0	11.0	12.0	4.0	11	10
6166050	20 8	8.0	25.0	12.0	12.0	5.0	14	10
6166130	20 9	9.0	25.0	13.0	13.0	5.0	16	10
6166210	20 10	10.0	25.0	14.7	14.7	6.0	18	10
6166480	20 11	11.0	25.0	16.0	16.0	7.0	25	10
6166560	20 12	12.0	25.0	17.0	17.0	8.0	29	10
6166640	20 13	13.0	25.0	18.5	18.5	8.0	30	10
6166720	20 14	14.0	25.0	19.7	19.7	10.0	37	10

Code	No.	AF	L	d ₁	d ₂	t	90°	10°
6167020	20 3/16AF	3/16	25.0	7.8	12.0	2.5	9	1
6167100	20 7/32AF	7/32	25.0	8.8	12.0	3.0	9	1
6167290	20 1/4AF	1/4	25.0	9.8	12.0	3.5	25	1
6167370	20 9/32AF	9/32	25.0	11.0	12.0	4.0	10	1
6167450	20 5/16AF	5/16	25.0	12.0	12.0	5.0	13	1
6167530	20 11/32AF	11/32	25.0	13.0	13.0	5.0	15	1
6167610	20 3/8AF	3/8	25.0	14.0	14.0	6.0	18	1
6167880	20 7/16AF	7/16	25.0	16.0	16.0	7.0	23	1
6167960	20 1/2AF	1/2	25.0	18.0	18.0	8.0	29	1
6161840	20 9/16AF	9/16	25.0	20.0	20.0	10.0	36	1

 **Whitw.**

Code	No.	BA	L	d ₁	d ₂	t	90°	10°
6168500	20 8BA	8	25.0	6.7	12.0	2.0	9	1
6168690	20 7BA	7	25.0	7.3	12.0	2.3	9	1
6168770	20 6BA	6	25.0	8.0	12.0	2.5	9	1
6168850	20 5BA	5	25.0	8.8	12.0	3.0	9	1
6168930	20 4BA	4	25.0	9.8	12.0	3.5	10	1
6169070	20 3BA	3	25.0	11.0	12.0	4.0	10	1
6169150	20 2BA	2	25.0	12.0	12.0	5.0	12	1
6169230	20 1BA	1	25.0	13.0	13.0	5.0	15	1
6169310	20 0BA	0	25.0	15.0	15.0	7.0	19	1

 **S 1023 M**



72

 **20 LMU 10**



161

 **1500 ES/CT-20 BIT**
1500 CT-20-19-U20



86 91



1/4"



20 L

SOCKET 1/4" hexagon, long pattern

- Acc. to DIN 3124, ISO 2725-1
- Square drive as per DIN 3120 - C 6.3, ISO 1174, with ball retaining groove
- Hand-operated, knurled grip
- GEDORE vanadium steel 31CrV3, polished, chrome-plated

6,3

1/4"

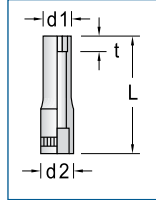

mm

Code	No.	mm	L	d ₁	d ₂	t	±	±
6191400	20 L 4	4.0	50	6.9	12.0	3.0	17	5
6191590	20 L 4,5	4.5	50	7.5	12.0	3.4	17	5
6191670	20 L 5	5.0	50	8.2	12.0	3.7	18	5
6191750	20 L 5,5	5.5	50	8.8	12.0	4.5	19	5
6191830	20 L 6	6.0	50	9.4	12.0	5.2	20	5
6191910	20 L 7	7.0	50	11.0	12.0	6.0	24	5
6192050	20 L 8	8.0	50	12.0	12.0	7.5	27	10
6192130	20 L 9	9.0	50	13.0	13.0	7.5	30	5
6192210	20 L 10	10.0	50	14.7	14.7	9.0	33	10
6192480	20 L 11	11.0	50	16.0	16.0	10.5	47	5
6192560	20 L 12	12.0	50	17.0	17.0	12.0	50	5
6192640	20 L 13	13.0	50	18.5	18.5	12.0	54	10

AF

Code	No.	AF	L	d ₁	d ₂	t	±	±
6192800	20 L 3/16AF	3/16	50	7.8	12.0	3.7	16	1
6192990	20 L 7/32AF	7/32	50	8.8	12.0	4.5	17	1
6193020	20 L 1/4AF	1/4	50	9.8	12.0	5.2	17	1
6193100	20 L 9/32AF	9/32	50	11.0	12.0	6.0	22	1
6193290	20 L 5/16AF	5/16	50	12.0	12.0	7.5	25	1
6193370	20 L 11/32AF	11/32	50	13.0	13.0	7.5	29	1
6193450	20 L 3/8AF	3/8	50	14.0	14.0	9.0	33	1
6193530	20 L 7/16AF	7/16	50	16.0	16.0	10.5	43	1
6193610	20 L 1/2AF	1/2	50	18.0	18.0	12.0	54	1

D 20

SOCKET 1/4" bi-hexagon UD profile

- Square drive as per DIN 3120 - C 6.3, ISO 1174, with ball retaining groove
- Hand-operated, knurled grip
- GEDORE vanadium steel 31CrV3, polished, chrome-plated

6,3

1/4"

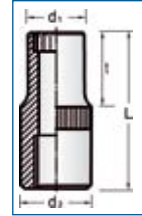

mm

Code	No.	mm	L	d ₁	d ₂	t	±	±
1649558	D 20 4	4.0	25.0	6.9	12.0	2.0	9	1
1649566	D 20 4,5	4.5	25.0	7.5	12.0	2.3	8	1
1649574	D 20 5	5.0	25.0	8.2	12.0	2.5	11	1
1802402	D 20 5,5	5.5	25.0	8.8	12.0	3.0	12	1
1649582	D 20 6	6.0	25.0	9.4	12.0	3.5	10	1
1649590	D 20 7	7.0	25.0	11.0	12.0	4.0	13	1
6225750	D 20 8	8.0	25.0	12.0	12.0	5.0	13	5
6225830	D 20 9	9.0	25.0	13.0	13.0	5.0	15	1
6226050	D 20 10	10.0	25.0	14.7	14.7	6.0	20	5
6226130	D 20 11	11.0	25.0	16.0	16.0	7.0	24	1
6226480	D 20 12	12.0	25.0	17.0	17.0	8.0	26	1
6226640	D 20 13	13.0	25.0	18.5	18.5	8.0	29	5
6226720	D 20 14	14.0	25.0	19.7	19.7	10.0	36	1

AF

Code	No.	AF	L	d ₁	d ₂	t	±	±
1812505	D 20 3/16AF	3/16	25.0	7.8	12.0	2.5	10	1
1812513	D 20 7/32AF	7/32	25.0	8.8	12.0	3.0	11	1
1812521	D 20 1/4AF	1/4	25.0	9.8	12.0	3.5	11	1
1812548	D 20 9/32AF	9/32	25.0	11.0	12.0	4.0	12	1
6226800	D 20 5/16AF	5/16	25.0	12.0	12.0	5.0	12	1
6226990	D 20 11/32AF	11/32	25.0	13.0	13.0	5.0	15	1
6227020	D 20 3/8AF	3/8	25.0	14.0	14.0	6.0	17	1
1901702	D 20 13/32AF	13/32	25.0	15.0	15.0	6.0	20	1
6227370	D 20 7/16AF	7/16	25.0	16.0	16.0	7.0	22	1
6227450	D 20 1/2AF	1/2	25.0	18.0	18.0	8.0	28	1
6228180	D 20 9/16AF	9/16	25.0	20.0	20.0	10.0	34	1

DG 20

SWIVEL SOCKET 1/4" UD profile

- Square drive as per DIN 3120 - C 6.3, ISO 1174, with ball retaining groove
- Hand-operated
- UD-profile
- GEDORE vanadium steel 31CrV3, chrome-plated

6,3

1/4"

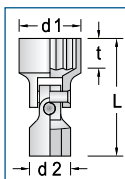

mm

AF

Code	No.	mm	L	d ₁	d ₂	t	±	±
2190648	DG 20 5,5	5.5	38.0	8.8	14	3.0	30	1
2190656	DG 20 6	6.0	38.0	9.4	14	3.5	30	1
2190664	DG 20 7	7.0	38.0	11.0	14	4.0	30	1
2190680	DG 20 8	8.0	38.0	12.0	14	5.0	30	1
2190699	DG 20 9	9.0	38.0	13.0	14	5.0	50	1
2190702	DG 20 10	10.0	39.0	14.7	14	6.0	40	1
2190729	DG 20 11	11.0	41.0	16.0	14	7.0	40	1
2190737	DG 20 12	12.0	42.0	17.0	14	8.0	30	1
2190745	DG 20 13	13.0	42.0	18.5	14	8.0	40	1

Code	No.	AF	L	d ₁	d ₂	t	±	±
1965336	DG 20 1/4AF	1/4	38.0	9.8	14	3.5	25	1
1965344	DG 20 5/16AF	5/16	38.0	12.0	14	5.0	26	1
1965352	DG 20 3/8AF	3/8	39.0	14.0	14	6.0	27	1
1965360	DG 20 7/16AF	7/16	41.0	16.0	14	7.0	10	1
1965379	DG 20 1/2AF	1/2	42.0	18.0	14	8.0	10	1
1965387	DG 20 9/16AF	9/16	43.5	20.0	14	9.0	10	1

TX 20

SOCKET 1/4" for protruding TORX® head screws

- Square drive as per DIN 3120 - C 6.3, ISO 1174, with ball retaining groove
- Hand-operated, knurled grip
- GEDORE vanadium steel 31CrV3, polished, chrome-plated
- TORX® = reg. trademark of Acument Intellectual Properties, LLC. USA

6.3

1/4"

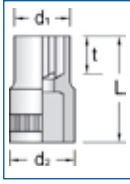

Code	No.	Ø	□ mm	★ mm	L	d ₁	d ₂	t	↺↻	⊞
6193880	TX 20 E4	E4	M3	3.86	25	5.5	12	4.5	8	5
6187640	TX 20 E5	E5	M4	4.73	25	7.0	12	5.0	9	5
6187720	TX 20 E6	E6	M5	5.74	25	8.0	12	5.0	10	5
6187800	TX 20 E7	E7	M6	6.16	25	9.5	12	6.0	11	5
6187990	TX 20 E8	E8	M6 - M7	7.52	25	10.5	12	6.5	14	5
6193960	TX 20 E10	E10	M8	9.42	25	13.0	13	7.0	18	5



1/4"

ITX 20

SCREWDRIVER BIT SOCKET 1/4" for recessed TORX® head screws

- Square drive as per DIN 3120 - C 6.3, ISO 1174, with ball retaining groove
- Hand-operated, knurled grip
- Chrome-plated
- With pressed-in pin in GEDORE vanadium special steel, gun-metal finish
- TORX® = reg. trademark of Acument Intellectual Properties, LLC. USA

6.3

1/4"

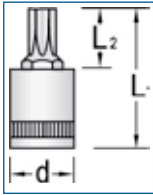

Code	No.	★	□ mm	★ mm	L ₁	L ₂	d	↺↻	⊞
6190430	ITX 20 T8	T8	M2,5	2.31	30.5	14.5	12	13	10
6190510	ITX 20 T9	T9	M3	2.50	30.5	14.5	12	13	10
6190780	ITX 20 T10	T10	M3 - M3,5	2.74	30.5	14.5	12	14	10
6190860	ITX 20 T15	T15	M3,5 - M4	3.27	30.5	14.5	12	14	10
6190940	ITX 20 T20	T20	M4 - M5	3.86	30.5	14.5	12	14	10
6191080	ITX 20 T25	T25	M4,5 - M5	4.43	30.5	14.5	12	14	10
6191160	ITX 20 T27	T27	M4,5 - M6	4.99	30.5	14.5	12	14	10
6191240	ITX 20 T30	T30	M6 - M7	5.52	30.5	14.5	12	15	10
6265890	ITX 20 T40	T40	M7 - M8	6.65	33.5	14.0	14	25	10

ITX 20 IP

SCREWDRIVER BIT SOCKET 1/4" for recessed TORX PLUS® head screws

- Square drive as per DIN 3120 - C 6.3, ISO 1174, with ball retaining groove
- Hand-operated, knurled grip
- Chrome-plated
- With pressed-in pin in GEDORE vanadium special steel, gun-metal finish
- TORX PLUS® = reg. trademark of Acument Intellectual Properties, LLC. USA

6.3

1/4"

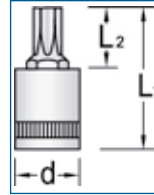

Code	No.	★	□ mm	★ mm	L ₁	L ₂	d	↺↻	⊞
1815431	ITX 20 6IP	6IP	M2	2.31	30.5	14.5	12	13	1
1815458	ITX 20 8IP	8IP	M2,5 - M3	2.50	30.5	14.5	12	13	1
1815466	ITX 20 10IP	10IP	M3 - M3,5	2.74	30.5	14.5	12	13	1
1815474	ITX 20 15IP	15IP	M3,5 - M4	3.27	30.5	14.5	12	13	1
1815482	ITX 20 20IP	20IP	M4 - M5	3.86	30.5	14.5	12	14	1
1815490	ITX 20 25IP	25IP	M4,5 - M5	4.43	30.5	14.5	12	14	1
1827898	ITX 20 27IP	27IP	M5 - M6	4.99	30.5	14.5	12	14	1
1815504	ITX 20 30IP	30IP	M6	5.52	30.5	14.5	12	15	1
1815512	ITX 20 40IP	40IP	M7 - M8	6.65	33.5	14.0	14	25	1

ITX 20 K

SCREWDRIVER BIT SOCKET 1/4" with ball end, for recessed TORX® head screws

- Square drive as per DIN 3120 - C 6.3, ISO 1174, with ball retaining groove
- Hand-operated, knurled grip
- Chrome-plated
- With pressed-in pin in GEDORE vanadium special steel, gun-metal finish
- Swivel angle approx. 15-20°
- Optimum transfer of power, also at places which are difficult of access
- TORX® = reg. trademark of Acument Intellectual Properties, LLC. USA

6.3

1/4"

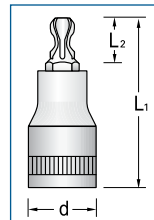

Code	No.	★	□ mm	★ mm	L ₁	L ₂	d	↺↻	⊞
6120220	ITX 20 KT10	T10	M3 - M3,5	2.74	30.5	14.5	12	15	1
6120300	ITX 20 KT15	T15	M3,5 - M4	3.27	30.5	14.5	12	15	1
6120490	ITX 20 KT20	T20	M4 - M5	3.86	30.5	14.5	12	15	1
6120570	ITX 20 KT25	T25	M4,5 - M5	4.43	30.5	14.5	12	15	1
6120650	ITX 20 KT27	T27	M4,5 - M6	4.99	30.5	14.5	12	15	1
6120730	ITX 20 KT30	T30	M6 - M7	5.52	30.5	14.5	12	15	1
6120810	ITX 20 KT40	T40	M7 - M8	6.65	33.5	14.0	14	25	1



IS 20

SCREWDRIVER BIT SOCKET 1/4" for slotted head screws

- ▶ Square drive as per DIN 3120 - C 6.3, ISO 1174, with ball retaining groove
- ▶ Hand-operated, knurled grip
- ▶ Chrome-plated
- ▶ Bit in GEDORE vanadium special steel, manganese-phosphated
- ▶ Bit as per DIN ISO 2380-1 Form B

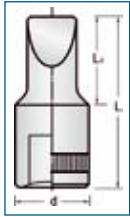

Code	No.	mm	mm	L ₁	L ₂	d	↺	↻
6171560	IS 20 4x0,8	0.8	4.0	28	14.5	12	11	10
6171640	IS 20 5,5x1	1.0	5.5	28	14.5	12	12	10
6174230	IS 20 6,5x1,2	1.2	6.5	28	14.5	12	12	10
6174310	IS 20 8x1,6	1.6	8.0	28	14.5	12	12	10

IKS 20

SCREWDRIVER BIT SOCKET 1/4" for cross-slotted head screws PH

- ▶ Square drive as per DIN 3120 - C 6.3, ISO 1174, with ball retaining groove
- ▶ Hand-operated, knurled grip
- ▶ Chrome-plated
- ▶ Bit in GEDORE vanadium special steel, manganese-phosphated
- ▶ Bit as per DIN DIN ISO 8764-1 PH

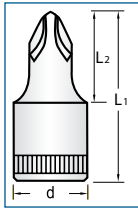

Code	No.	Φ PH	L ₁	L ₂	d	↺	↻
6174580	IKS 20 1	1	28	14.5	12	11	10
6174660	IKS 20 2	2	28	14.5	12	12	10
6174740	IKS 20 3	3	28	14.5	12	12	10
6174820	IKS 20 4	4	28	14.5	12	14	10

IKS 20 PZD

SCREWDRIVER BIT SOCKET 1/4" for cross-slotted head screws PZ

- ▶ Square drive as per DIN 3120 - C 6.3, ISO 1174, with ball retaining groove
- ▶ Hand-operated, knurled grip
- ▶ Chrome-plated
- ▶ Bit in GEDORE vanadium special steel, manganese-phosphated
- ▶ Bit as per DIN DIN ISO 8764-1 PZ

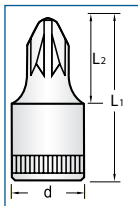

Code	No.	Φ PZ	L ₁	L ₂	d	↺	↻
6187130	IKS 20 PZD 1	1	28	14.5	12	12	10
6187210	IKS 20 PZD 2	2	28	14.5	12	13	10
6187480	IKS 20 PZD 3	3	28	14.5	12	14	10
6187560	IKS 20 PZD 4	4	28	14.5	12	15	10

IN 20

SCREWDRIVER BIT SOCKET 1/4" for in-hex screws

- ▶ Acc. to DIN 7422
- ▶ Square drive as per DIN 3120 - C 6.3, ISO 1174, with ball retaining groove
- ▶ Hand-operated, knurled grip
- ▶ Chrome-plated
- ▶ Bit in GEDORE vanadium special steel, manganese-phosphated
- ▶ * not standardised

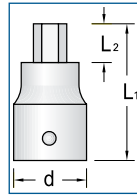

Code	No.	*	mm	L ₁	L ₂	d	↺	↻
1812556	IN 20 2	*	2.0	28	3.0	12	10	1
1707736	IN 20 2,5	*	2.5	28	3.5	12	10	1
6176010	IN 20 3		3.0	28	5.5	12	11	10
6176280	IN 20 4		4.0	28	7.0	12	11	10
6176360	IN 20 5		5.0	28	8.0	12	12	10
6178490	IN 20 6		6.0	28	8.5	12	13	10
6178570	IN 20 8	*	8.0	28	10.0	12	16	10

IN 20 L

SCREWDRIVER BIT SOCKET 1/4" for in-hex screws, long pattern

- ▶ Acc. to DIN 7422
- ▶ Square drive as per DIN 3120 - C 6.3, ISO 1174, with ball retaining groove
- ▶ Hand-operated, knurled grip
- ▶ Chrome-plated
- ▶ Bit in GEDORE vanadium special steel, manganese-phosphated

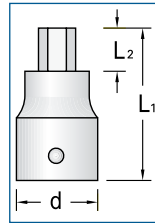

Code	No.	mm	L ₁	L ₂	d	↺	↻
1933256	IN 20 L 3-60	3	60	32	12	24	1
1933264	IN 20 L 4-60	4	60	32	12	25	1
1933272	IN 20 L 5-60	5	60	32	12	27	1
1933280	IN 20 L 6-60	6	60	32	12	29	1
1933299	IN 20 L 8-60	8	60	32	14	50	1

IN 20 K

SCREWDRIVER BIT SOCKET 1/4" with ball end, for in-hex screws

- ▶ Square drive as per DIN 3120 - C 6.3, ISO 1174, with ball retaining groove
- ▶ Hand-operated, knurled grip
- ▶ Chrome-plated
- ▶ With pressed-in pin, manganese-phosphated
- ▶ Total swivel angle approx. 15-20°

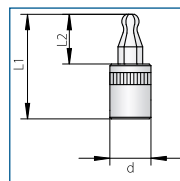

Code	No.	mm	L ₁	L ₂	d	↺	↻
2219409	IN 20 K 4	4	30.5	14.5	12	10	1
2219417	IN 20 K 5	5	30.5	14.5	12	10	1
2219468	IN 20 K 6	6	30.5	14.5	12	13	1

ACCESSORIES 6.3 MM (1/4")

2030

CONVERTOR 1/4" TO 3/8"

- Acc. to DIN 3123, ISO 3316
- For hand-operated sockets with square drive as per DIN 3120, ISO 1174, with ball locking device
- GEDORE vanadium steel 31CrV3, polished, chrome-plated

6.3
1/4"
10
3/8"



Code	No.	□"	□	■"	■	↳mm↳	↕	⊞
6170080	2030	1/4	6.3	3/8	10	26	20	10

2087

SLIDING T BAR 1/4"

- Acc. to DIN 3122, ISO 3315
- For hand-operated sockets with square drive as per DIN 3120, ISO 1174, with ball locking device
- GEDORE vanadium steel 31CrV3, polished, chrome-plated

6.3
1/4"



Code	No.	■"	■	↳mm↳	↕	⊞
6170160	2087	1/4	6.3	115	39	5

2087 A

SLIDING T BAR WITH RELEASE 1/4"

- Secured against unintentional removal
- GEDORE vanadium steel 31CrV3, polished, chrome-plated
- Turn handle for easy locking and releasing
- Accidental release when working is prevented because of the asymmetrical release point
- Ideal for situations where sockets must not become detached
- Examples: Aircraft engine, work in deep machine bodies
- DBGM

6.3
1/4"



Code	No.	■"	■	↳mm↳	↕	⊞
1834398	2087 A	1/4	6.3	115	48	1

2088

FLEXIBLE EXTENSION 1/4"

- For hand-operated sockets with square drive as per DIN 3120, ISO 1174, with ball locking device
- GEDORE vanadium steel 31CrV3, polished, chrome-plated

6.3
1/4"



Code	No.	■"	■	↳mm↳	↕	⊞
6170240	2088	1/4	6.3	120	46	10

2090

EXTENSION 1/4"

- Acc. to DIN 3123, ISO 3316
- For hand-operated sockets with square drive as per DIN 3120, ISO 1174, with ball locking device
- GEDORE vanadium steel 31CrV3, polished, chrome-plated
- * not standardised

6.3
1/4"



Code	No.	*	■"	■	↳mm↳	↕	⊞
6170320	2090-2		1/4	6.3	55	25	10
6170400	2090-4		1/4	6.3	97	41	10
6171210	2090-6		1/4	6.3	148	61	10
6173340	2090-12	*	1/4	6.3	305	124	1

2090 A

EXTENSION 1/4" with release

- Easy access to deep-fitting screws in confined areas
- No unintentional release of the socket from the extension due to safety ring
- For hand-operated sockets with square drive as per DIN 3120, ISO 1174, ball locking device

6.3
1/4"



Code	No.	■"	■	↳mm↳	↕	⊞
1932284	2090 A-2	1/4	6.3	55	30	1
1932292	2090 A-4	1/4	6.3	97	50	1
1932306	2090 A-12	1/4	6.3	305	125	1

2090 KR

UNIVERSAL EXTENSION 1/4"

- With ball end
- For hand-operated sockets with square drive as per DIN 3120, ISO 1174, with ball locking device
- The extension is able to pivot up to 15°
- GEDORE vanadium steel 31CrV3, polished, chrome-plated

6.3
1/4"



Code	No.	■"	■	↳mm↳	↕	⊞
1812564	2090 KR-2	1/4	6.3	55	24	1
1812572	2090 KR-4	1/4	6.3	97	45	1
6121030	2090 KR-6	1/4	6.3	148	60	1

2094

COUPLER 1/4"

- Acc. to DIN 3122, ISO 3315
- For hand-operated sockets with square drive as per DIN 3120, ISO 1174, with ball locking device
- GEDORE vanadium steel 31CrV3, polished, chrome-plated

6.3
1/4"



Code	No.	■"	■	↳mm↳	↕	⊞
6170830	2094	1/4	6.3	19.8	6	10

2095

UNIVERSAL JOINT 1/4"

- Acc. to DIN 3123, ISO 3316
- For hand-operated sockets with square drive as per DIN 3120, ISO 1174, with ball locking device
- GEDORE vanadium steel 31CrV3, polished, chrome-plated

Code	No.	1/4"	6.3	1/4"	6.3	mm	mm	mm
6170910	2095	1/4	6.3	1/4	6.3	38	26	10

2097

SWIVEL HANDLE 1/4"

- Acc. to DIN 3122, ISO 3315
- For hand-operated sockets with square drive as per DIN 3120, ISO 1174, with ball locking device
- GEDORE vanadium steel 31CrV3, polished, chrome-plated, square drive manganese-phosphated

Code	No.	1/4"	6.3	mm	mm	mm
6171050	2097	1/4	6.3	146	94	1

2098

DRIVING HANDLE 1/4"

- Acc. to DIN 3122, ISO 3315
- For hand-operated sockets with square drive as per DIN 3120, ISO 1174, with ball locking device

Code	No.	1/4"	6.3	mm	mm	mm
6171480	2098	1/4	6.3	140	70	10

2098 K

DRIVING HANDLE 1/4" short pattern

- For hand-operated sockets with square drive as per DIN 3120, ISO 1174, with ball locking device

Code	No.	1/4"	6.3	mm	mm	mm
1953788	2098 K	1/4	6.3	70	34	1

2098 T

DRIVING HANDLE 1/4"

- For hand-operated sockets with square drive as per DIN 3120, ISO 1174, with ball locking device
- With bit adaptor no. 620 also suitable for 1/4" bits
- Easy access to deep-fitting screws in confined areas
- The danger of the tool canting, is reduced by the central positioning of the square drive
- With hanging hole
- GEDORE vanadium steel 31CrV3, chrome-plated

Code	No.	1/4"	6.3	mm	mm	mm
1939998	2098 T	1/4	6.3	300	150	1

2099

TELESCOPIC EXTENSION 1/4" magnetic

- With 1/4" female square drive and 1/4" female hexagon drive
- Automatic, form-fit connection
- Adjustable in 10 mm steps from 186-296 mm
- Suitable for 1/4" bits as well as with adaptor no. 673 for sockets up to 13 mm
- Made of quality steel, manganese-phosphated resp. chrome-plated

Code	No.	1/4"	6.3	1/4"	6.3	mm	mm	mm
1888455	2099	1/4	6.3	1/4	6.3	186-296	205	1

SL 2013

TOOL HOLDING RAIL, MAGNETIC 1/4" empty

- External squares to take 13 standard commercial 6.3 mm (1/4") sockets
- Two female square adaptors to take ratchets, sliding T bars, extensions etc.
- A strong magnet securely holds the socket rail to ferrous metals
- Additional holes are provided for wall mounting the socket rail or attaching to non-ferrous materials
- The sockets are securely locked by the ball at the square-drive end by turning them 90°
- It is a simple matter to "unlock" and remove the sockets, by turning them 90° in the opposing direction
- Delivery without tools

Code	No.	mm	mm	mm	mm
1761080	SL 2013	380	33	355	1

S 2032-05

ADAPTOR SET 1/4" 5 pieces

- Set of reducers and converters 1/4" - 3/4"
- Reducers 1930, 3020
- Convertors 2030, 3019, 1932
- In transparent plastic box, dimensions: L 134 x W 51 x H 51 mm, foam insert light-blue
- Please take note of the maximum capacity of the external squares of the reducers acc. to DIN 3123, ISO 3316

Code	No.	Contents	mm	mm
1729071	S 2032-05	2030 1/4-1/4 3020 1/4-1/4 3019 1/4-1/4 1930 1/4-3/4 1932 1/4-3/4	340	1

SETS 6.3 MM (1/4") MM+INCH

6.3 1/4"

- New classification into basic, supplementary, compact and volume sets
- Socket drivers and/or practical accessories in proven GEDORE quality
- With "Check-Tool-System": 2-colour plastic insert to check that the set is complete

BASIC SETS

D 20 DM

SOCKET SET 1/4" 14 pieces

- With UD profile sockets made from GEDORE vanadium steel 31CrV3, hand-operated
- With driving handle and adaptor
- In plastic case
- Dimensions: 160 x 95 x 38 mm

6.3 1/4"



mm

Code	No.	Sockets	Accessories		
1815563	D 20 DM	⊖ D 20 4 4,5 5 5,5 6 7 8 9 10 11 12 13	673 6,3	357	1
			676		

D 20 DMU-3

SOCKET SET 1/4" 14 pieces

- With UD profile sockets and accessories made from GEDORE vanadium steel 31CrV3, hand-operated
- With fine toothed, dial change ratchet
- In plastic case
- Dimensions: 160 x 95 x 38 mm

6.3 1/4"



mm

Code	No.	Ratchet	Sockets	Accessories		
1815598	D 20 DMU-3	⊙ U-3 2093 U-3	⊖ D 20 4 4,5 5 5,5 6 7 8 9 10 11 12 13	2090-4	429	1

D 20 DMU-3 T

SOCKET SET 1/4" 13 pieces

- With hand-operated UD profile sockets and accessories made from GEDORE vanadium steel 31CrV3
- With ratchet with T-handle and hand ratchet
- In plastic case
- Dimensions: 160 x 95 x 38 mm

6.3 1/4"



mm

Code	No.	Ratchet	Sockets	Accessories		
1815571	D 20 DMU-3 T	⊙ U-3 2093 U-3 T 2093 HR-94	⊖ D 20 4 5 6 7 8 9 10 11 12 13	2090 KR-4	414	1

SUPPLEMENTARY SETS

INS 20 PM

SCREWDRIVER BIT SOCKET SET 1/4" 15 pieces

- With hand-operated screwdriver bit sockets in GEDRE vanadium special steel
- In plastic case
- Dimensions: 160 x 95 x 38 mm

6.3 1/4"



Code	No.	Sockets		
1815601	INS 20 PM	⊙ IN 20 3 4 5 6 8 ⊖ IS 20 4 5,5 6,5 8 ⊕ IKS 20 1 2 3 ⊕ IKS 20 PZD 1 2 3	285	1

ITX 20 TX-015

SCREWDRIVER BIT SOCKET SET 1/4" 15 pieces

- With hand-operated screwdriver bit sockets in GEDRE vanadium special steel
- In plastic case
- Dimensions: 160 x 95 x 38 mm
- TORX® = reg. trademark of Acument Intellectual Properties, LLC. USA

6.3 1/4"



Code	No.	Sockets		
1815628	ITX 20 TX-015	⊙ ITX 20 T8 T9 T10 T15 T20 T25 T27 T30 T40 ⊕ TX 20 E4 E5 E6 E7 E8 E10	307	1

ITX 20 PM

SCREWDRIVER BIT SOCKET SET 1/4" 9 pieces

- With hand-operated screwdriver bit sockets in GEDRE vanadium special steel
- In plastic case
- Dimensions: 110 x 65 x 31 mm
- TORX® = reg. trademark of Acument Intellectual Properties, LLC. USA

6.3 1/4"



Code	No.	Sockets		
1815636	ITX 20 PM	⊙ ITX 20 T8 T9 T10 T15 T20 T25 T27 T30 T40	174	1

COMPACT SETS

D 20 EMU-3

SOCKET SET 1/4" 17 pieces

- With forged, tempered UD profile sockets, hand-operated
- With accessories made from GEDORE vanadium steel 31CrV3
- With fine toothed, dial change ratchet
- In plastic case
- Dimensions: 200 x 120 x 38 mm



mm

Code	No.	Ratchet	Sockets	Accessories	↔	📦
1815652	D 20 EMU-3	U-3 2093 U-3	D 20 4 4,5 5 5,5 6 7 8 9 10 11 13	2087 2090-4 2095 676 673 6,3	625	1

D 20 KMU-20

SOCKET SET 1/4" 37 pieces

- With forged, tempered UD profile sockets, hand-operated
- With accessories made from GEDORE vanadium steel 31CrV3
- With robust lever-change reversible ratchet with push-button release
- In plastic case
- Dimensions: 200 x 120 x 38 mm
- TORX* = reg. trademark of Acument Intellectual Properties, LLC. USA



mm

Code	No.	Ratchet	Sockets	Accessories	↔	📦
1822373	D 20 KMU-20	U-20 2093 U-20	D 20 4 5 6 7 8 9 10 11 12 13 680 4 5,5 6,5 685 3 4 5 6 685 X 5 6 8 687 TX T10 T15 T20 T25 T27 T30 T40 690 1 2 690 PZD 1 2 3	2090-4 620 676 699	712	1

D 20 KAU-20

SOCKET SET 1/4" 37 pieces

- With forged, tempered UD profile sockets, hand-operated
- With accessories made from GEDORE vanadium steel 31CrV3
- With robust lever-change reversible ratchet with push-button release
- In plastic case
- Dimensions: 200 x 120 x 38 mm
- TORX* = reg. trademark of Acument Intellectual Properties, LLC. USA

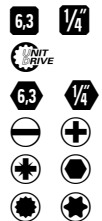

"AF

Code	No.	Ratchet	Sockets	Accessories	↔	📦
2010348	D 20 KAU-20	U-20 2093 U-20	D 20 3/16 7/32 1/4 9/32 5/16 11/32 3/8 13/32 7/16 1/2" 680 4 5,5 6,5 685 1/8 5/32 3/16 1/4" 685 X 5 6 8 687 TX T10 T15 T20 T25 T27 T30 T40 690 1 2 690 PZD 1 2 3	2090-4 620 676 699	656	1

D 20 MOT

BASIC TOOL SET 1/4" FOR MOTORBIKES 30 pieces

- Packed with a basic assortment of tools for emergencies on motorbikes
- In plastic case
- Dimensions: 160 x 95 x 38 mm



mm

Code	No.	Ratchet	Sockets	Accessories	↔	📦
2190281	D 20 MOT	U-3 2093 U-3 T	D 20 8 9 10 11 12 13 14 685 3 4 5 6 8 10 687 TX T10 T15 T20 T25 T27 T30 T40 690 1 2 3 680 4 6,5	2090 KR-4 2090-6 2095 620	572	1

D 20 MOT-A

BASIC TOOL SET 1/4" FOR MOTORBIKES 30 pieces

- Packed with a basic assortment of tools for emergencies on motorbikes
- In plastic case
- Dimensions: 160 x 95 x 38 mm



"AF

Code	No.	Ratchet	Sockets	Accessories	↔	📦
2193159	D 20 MOT-A	U-3 2093 U-3 T	D 20 1/4 5/16 3/8 13/32 7/16 1/2 9/16" 685 1/8 5/32 3/16 1/4 5/16 3/8" 687 TX T10 T15 T20 T25 T27 T30 T40 690 1 2 3 680 4 6,5	2090 KR-4 2090-6 2095 620	572	1

D 20 TMU-10

SOCKET SET 1/4" 40 pieces

- ✔ With forged, tempered UD profile sockets, hand-operated
- ✔ With accessories made from GEDORE vanadium steel 31CrV3
- ✔ With robust lever change reversible ratchet
- ✔ In plastic case
- ✔ Dimensions: 200 x 120 x 38 mm
- ✔ TORX® = reg. trademark of Acument Intellectual Properties, LLC. USA

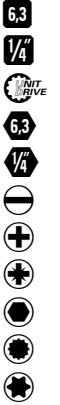

mm

Code	No.	Ratchet	Sockets	Accessories		
1815660	D 20 TMU-10	U-10 2093 U-10	D 20 4 5 6 7 8 9 10 11 12 13 680 4 6 5 685 3 4 5 6 8 685 X 5 6 8 687 TX T10 T15 T20 T25 T27 T30 T40 690 1 2 690 PZD 1 2 3	620 639 673 6,3 676 699 2095 2090-4	767	1

20 XLU-3 T

SOCKET SET 1/4" 37 pieces

- ✔ With forged, tempered hexagon sockets, hand-operated, made from GEDORE vanadium steel 31CrV3
- ✔ Screwdriver bits made from GEDORE vanadium special steel
- ✔ With T-handle ratchet and telescopic extension no. 2099, adjustable from 186-296 mm
- ✔ In plastic case
- ✔ Dimensions: 200 x 120 x 38 mm
- ✔ With "Check-Tool-System": 2-colour plastic insert to check that the set is complete
- ✔ TORX® = reg. trademark of Acument Intellectual Properties, LLC. USA

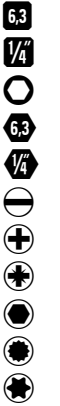

mm

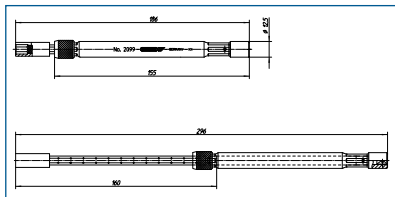

Code	No.	Ratchet	Sockets	Accessories		
1888447	20 XLU-3 T	2093 U-3 T	20 4 5 6 7 8 9 10 11 12 13 680 4 6 5 685 3 4 5 6 685 X 5 6 8 687 TX T8 T9 T10 T15 T20 T25 T27 T30 T40 690 1 2 690 PZD 1 2 3	673 6,3 2099 2095	800	1



VOLUME SETS

D 20 FMU-20

SET FOR PRECISION MECHANICS 1/4" + 4 MM 52 pieces

- Practical tool set for precision mechanical work
- Includes practical pickup tool for bits, no. 635, for easy replacement of the bits in the socket
- Two ratchets for different applications:
 - Fine-toothed reversible lever ratchet no. 2093 U-20 for high-torque
 - Bit ratchet no. 471, combined with socket holder no. 673, allows the use of sockets in extremely confined spaces
- With GEDORE Check-Tool system: missing tool check using two colour plastic inserts



mm

Code	No.	Ratchet	Sockets	Accessories	Weight	Volume
2000237	D 20 FMU-20	471 U-20 2093 U-20	480 0,8 1,2 1,5 1,8 485 0,7 0,9 1,3 1,5 490 PH 000 00 0 490 PZD 000 00 0 487 TX T3 T4 T5 T6 T7 T8 D 20 4 4,5 5 5,5 6 7 8 685 2 2,5 3 4 5 687 TX T9 T10 T15 T20 T25 690 1 2 690 PZD 1 2 64x4,5 5x5,5 7x8	420 499 620 2090 KR-4 673 K 635	810	1

D 20 WMU-3

SOCKET SET 1/4" 29 pieces

- With forged, tempered UD profile sockets, hand-operated
- Accessories in GEDORE vanadium steel 31CrV3
- With fine toothed, dial change ratchet
- In plastic case
- Dimensions: 275 x 150 x 42 mm



mm

Code	No.	Ratchet	Sockets	Accessories	Weight	Volume
1815679	D 20 WMU-3	U-3 2093 U-3	D 20 4 4,5 5 5,5 6 7 8 9 10 11 12 13 8 4 5 5,5 6 7 8 9 10 11 13	639 673 6,3 676 2095 2090-2 -4	995	1

20 LMU-10

SOCKET SET 1/4" 49 pieces

- With forged, tempered long hexagon and short UD profile sockets, hand-operated
- Accessories in GEDORE vanadium steel 31CrV3
- With robust lever change reversible ratchet
- In plastic case
- Dimensions: 275 x 150 x 42 mm
- TORX® = trademark of Acument Intellectual Properties, LLC. USA



mm

Code	No.	Ratchet	Sockets	Accessories	Weight	Volume
1815687	20 LMU-10	U-10 2093 U-10	D 20 4 5 6 7 8 9 10 11 12 13 20 L 4 4,5 5 6 7 8 9 10 12 13 680 4 6,5 685 3 4 5 6 8 685 X 5 6 8 687 TX T10 T15 T20 T25 T27 T30 T40 690 1 2 690 PZD 1 2 3	620 676 699 2090-2 -6 2095	1262	1

STANDARD SETS

20 EM

SOCKET SET 1/4" 16 pieces

- ✔ With forged, tempered hexagon sockets, hand-operated
- ✔ With accessories made from GEDORE vanadium steel 31CrV3
- ✔ Set U-10 with reversible with lever change ratchet
- ✔ Set U-3 with extra fine toothed, dial change ratchet
- ✔ Set Z-94 with ratchet handle with square coupler
- ✔ In plastic case
- ✔ Dimensions: 200 x 120 x 38 mm



6.3
1/4"

mm

Code	No.	Ratchet	Sockets	Accessories	Weight	Units
6172100	20 EMZ	Z-94 2093 Z-94	○ 20 4 4,5 5 5,5 6 7 8 9 10 11 13	2087 2090-4 2095 2098	761	1
6172290	20 EMU-3	U-3 2093 U-3	○ 20 4 4,5 5 5,5 6 7 8 9 10 11 13	2087 2090-4 2095 2098	776	1
6162220	20 EMU-10	U-10 2093 U-10	○ 20 4 4,5 5 5,5 6 7 8 9 10 11 13	2087 2090-4 2095 2098	790	1

20 EAU-3

SOCKET SET 1/4" 14 pieces

- ✔ With forged, tempered hexagon sockets, hand-operated
- ✔ With accessories made from GEDORE vanadium steel 31CrV3
- ✔ With extra fine toothed, dial change ratchet
- ✔ In plastic case
- ✔ Dimensions: 200 x 120 x 38 mm



6.3
1/4"

"AF"

Code	No.	Ratchet	Sockets	Accessories	Weight	Units
6172450	20 EAU-3	U-3 2093 U-3	○ 20 3/16 7/32 1/4 9/32 5/16 11/32 3/8 7/16 1/2"	2087 2090-4 2095 2098	767	1

20 IMU-3

SOCKET SET 1/4" 32 pieces

- ✔ With forged, tempered hexagon sockets, hand-operated
- ✔ With accessories made from GEDORE vanadium steel 31CrV3
- ✔ With fine toothed, dial change ratchet
- ✔ In plastic case
- ✔ Dimensions: 275 x 150 x 42 mm



6.3
1/4"

mm

Code	No.	Ratchet	Sockets	Accessories	Weight	Units
6174150	20 IMU-3	U-3 2093 U-3	○ 20 4 5 6 7 8 9 10 11 12 13 14 ⊖ IS 20 4 5,5 6,5 8 ● IN 20 3 4 5 6 8 ⊕ IKS 20 1 2 3 ⊕ IKS 20 PZD 1 2 3	2087 2090-2 -6 2095 2098	1298	1

20 ITU-3

SOCKET SET 1/4" 36 pieces

- With forged, tempered hexagon sockets, hand-operated
- With accessories made from GEDORE vanadium steel 31CrV3
- With fine toothed, dial change ratchet
- In attractive plastic case
- Dimensions: 275 x 150 x 42 mm
- TORX® = reg. trademark of Acument Intellectual Properties, LLC. USA



mm

Code	No.	Ratchet	Sockets	Accessories	Weight	Quantity
6196710	20 ITU-3	U-3 2093 U-3	O 20 4 5 6 7 8 9 10 11 12 13 14 ● IN 20 3 4 5 6 8 O TX 20 E4 E5 E6 E7 E8 E10 ● ITX 20 T8 T9 T10 T15 T20 T25 T27 T30	← 2087 ← 2090-2 -6 ← 2095 ← 2098	1376	1

DISPLAY BOXES

VB 20

DISPLAY BOX 1/4"

- For small sockets and bits
- Plastic box with removable dividers and labels for each article
- Dimensions: 330 x 250 x 55 mm

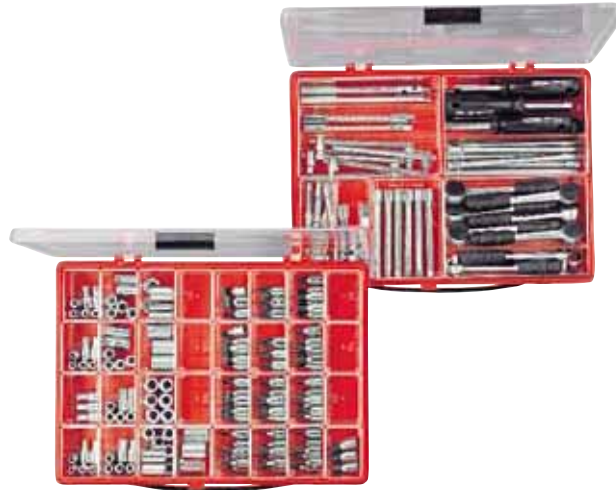

mm

Code	No.	Description	Sockets	Weight	Quantity
6182170	VB 20-I20	Display box with assortment S 20-I20 IN-IS-PH-PZ	VB 20-I20 L + S 20-I20	2.4	1
6182090	VB 20 ZB	Display box with assortment VB 20 ZB	VB 20 ZB L + S 20 ZB	2.5	1
6182330	S 20-I20	Socket set 1/4", 157 pieces IN-IS-PH-PZ	10x O 20 10 6x O 20 4 5 5,5 6 7 8 9 11 13 3x O 20 4,5 12 14 6x ● IN 20 3 4 5 6 3x ● IN 20 8 6x ⊖ IS 20 4 5,5 6,5 3x ⊖ IS 20 8 6x ⊕ IKS 20 1 2 3x ⊕ IKS 20 3 4 6x ⊕ IKS 20 PZD 1 2 3x ⊕ IKS 20 PZD 3 4	2.2	1
6182250	S 20 ZB	Accessory-set 1/4", 60 pieces	6x 2093 U-3 4x 2093 Z-94 6x 2087 6x 2090-4 -6 4x 2090-2 6x 2095 6x 2098 2x 2088 2x 2097 2x 2030 10x 2094	2.7	1

VS 20

DISPLAY BOX 1/4" 187 pieces

- VS 20-20 L-I20 consisting of: set S 20-I20 and 5 pcs each of 20 L 6 7 8 9 10 13
- In sheet metal rack
- Dimensions: 600 x 230 x 270 mm



mm

Code	No.	Contents	Weight	Quantity
6195820	VS 20-20 L-I20	Display stand with socket assortment 1/4" + 5 each 20 L 6 7 8 9 10 13	8.0	1
5434110	VS 20 L	Display stand complete without tools	5.3	1
5434030	VSB 20	Display stand with 9 compartments without tools	0.7	1
5433810	VSS 20	Sheet metal rack empty	3.3	1

10 MM (3/8") SQUARE DRIVE

10 **3/8"** **10** **3/8"**

www.gedore.com

RATCHETS 10 MM (3/8")

3093 U-20

REVERSIBLE RATCHET 3/8"

- Acc. to DIN 3122, ISO 3315
- Small, drop shaped head for confined areas
- Fine-toothed, with lever change and push-button release
- Non-slip 2-component handle with hanging hole
- For hand-operated sockets and accessories with square drive as per DIN 3120 - C 10, ISO 1174, ball locking device
- GEDORE vanadium steel 31CrV3, chrome-plated



10
3/8"

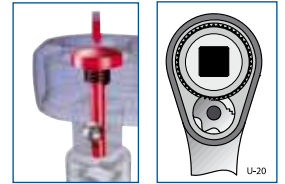

Code	No.	□"	■	∠°	↳mm↳	↳	↳T↳	↳
1556800	3093 U-20	3/8	10	6	200	29.7	292	5

3093 U-10

REVERSIBLE RATCHET 3/8"

- Acc. to DIN 3122, ISO 3315
- With lever change, locks in middle position, oval head
- Push-button release
- For hand-operated sockets and accessories with square drive as per DIN 3120 - C 10, ISO 1174, ball locking device
- GEDORE vanadium steel 31CrV3, chrome-plated



10
3/8"

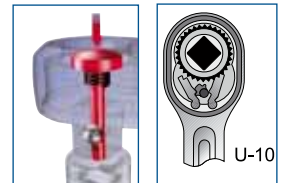

Code	No.	□"	■	∠°	↳mm↳	↳	↳T↳	↳
6236950	3093 U-10	3/8	10	11,25	200	30.2	254	5

3093 ALU-10

ALUMINIUM REVERSIBLE RATCHET 3/8"

- Design spec. similar to DIN 3122, ISO 3315
- Made from special-purpose drop-forged and hardened aluminium
- The mechanism as in all U-10 ratchets is made from high quality steel
- With lever change
- Push-button release
- Locks in the middle position: When the lever is flipped, it automatically engages for clockwise or counterclockwise operation
- For hand-operated sockets and accessories with square drive as per DIN 3120 - C 10, ISO 1174, ball locking device
- Extremely lightweight - just 158 g



10
3/8"

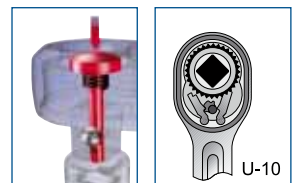

Code	No.	□"	■	∠°	↳mm↳	↳	↳T↳	↳
1900005	3093 ALU-10	3/8	10	11,25	200	30.2	350	1

3093 U-3

REVERSIBLE RATCHET 3/8"

- Acc. to DIN 3122, ISO 3315
- With non-slip metal disc change, fine-toothed and robust
- For hand-operated sockets and accessories with square drive as per DIN 3120 - C 10, ISO 1174, ball locking device
- GEDORE vanadium steel 31CrV3, chrome-plated



10
3/8"

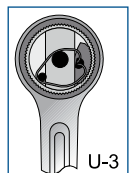

Code	No.	□"	■	∠°	↳mm↳	↳	↳T↳	↳
6237090	3093 U-3	3/8	10	5	200	33.5	244	5

3093 GU-3

SWIVEL HEAD REVERSIBLE RATCHET 3/8"

- Swivels through 180°, with joint lock
- With non-slip metal disc change, fine-toothed and robust
- Max. torque 200 N-m
- For hand-operated sockets and accessories with square drive as per DIN 3120 - C 10, ISO 1174, ball locking device
- GEDORE vanadium steel 31CrV3, chrome-plated



10
3/8"

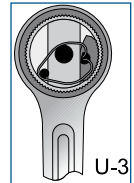

U-3

Code	No.	■"	■	↻°	↳mm↳	↔	↕	📦
6237170	3093 GU-3	3/8	10	5	282	33.5	525	5

3093 Z-94

RATCHET HANDLE WITH COUPLER 3/8"

- Acc. to DIN 3122, ISO 3315
- With square coupler, medium-fine toothed, extremely rugged
- For hand-operated sockets and accessories with square drive as per DIN 3120 - C 10, ISO 1174, ball locking device
- GEDORE vanadium steel 31CrV3, chrome-plated



10
3/8"

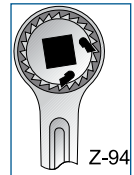

Z-94

Code	No.	■"	■	↻°	↳mm↳	↔	↕	📦
6237680	3093 Z-94	3/8	10	10	200	18	223	5

3093 U-10 K

PLASTIC RATCHET 3/8"

- For fast and easy tightening of bolted connections up to max. 70 N-m
- Very handy and compact, housing and handle form one unit
- Return angle 11.25°
- Made from sturdy compound material with a steel mechanism
- Dimensions: 44 x 145 x 39 mm
- Available in five colours
- European-Patent-No. 1136187



10
3/8"

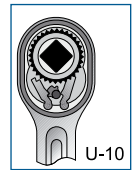

U-10

Code	No.	Colour	■"	■	↳mm↳	↻°	↕	📦
6242090	3093 U-10 K SCHWARZ	signal-black	3/8	10	145	11,25	197	1
6244970	3093 U-10 K GRÜN	moss-green	3/8	10	145	11,25	197	1
6248100	3093 U-10 K GRAU	anthracite-grey	3/8	10	145	11,25	197	1
6248290	3093 U-10 K BLAU	sky-blue	3/8	10	145	11,25	197	1
1505394	3093 U-10 K SIGNALGRAU	signal-grey	3/8	10	145	11,25	197	1

3093 U-3 T

RATCHET WITH T-HANDLE 3/8"

- Two-wing T-handle
- Ergonomic design for comfortable working
- For hand-operated sockets and accessories with square drive as per DIN 3120 - C 10, ISO 1174, ball locking device
- The danger of the tool canting, when carrying out work with extensions, is reduced by the central positioning of the square drive



10
3/8"



Code	No.	■"	■	↻°	↳mm↳	↔	📦
1973320	3093 U-3 T	3/8	10	5	140	68	1

SOCKETS 10 MM (3/8")



3/8"	UNIT DRIVE hexagon	UNIT DRIVE hexagon	UNIT DRIVE hexagon "AF"	UNIT DRIVE hexagon "AF"	UNIT DRIVE hexagon	Hexagon - external	Hexagon - external "AF"	Hexagon - external	Internal hexagon	Internal TORX®	Internal TORX® with pin	External TORX®	Internal serrations YZN	Slot	Cruciform PH	Cruciform PZ	Internal TORX PLUS®	Internal TORX® with ball end	Internal hexagon with ball end	Internal hexagon "AF"



30

SOCKET 3/8" hexagon

- ▲ Acc. to DIN 3124, ISO 2725-1
- ▲ Square drive as per DIN 3120 - C 10, ISO 1174, with ball retention groove
- ▲ Hand-operated, knurled grip
- ▲ GEDORE vanadium steel 31CrV3, polished, chrome-plated
- ▲ * not standardised

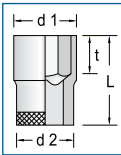

Code	No.	*		Ø mm	L	d ₁	d ₂	t		
6230160	30 6	*		6	28	9.7	17.5	5.0	24	10
6230240	30 7			7	28	11.0	17.5	5.0	24	10
6230320	30 8			8	28	12.1	17.5	9.0	28	10
6230400	30 9			9	28	13.5	17.5	9.0	27	10
6230590	30 10			10	28	14.7	17.5	9.0	28	10
6233850	30 11			11	28	16.0	17.5	9.0	30	10
6233930	30 12			12	28	17.2	18.3	9.0	33	10
6234070	30 13			13	28	18.5	17.5	9.0	32	10
6234150	30 14			14	29	19.7	18.4	11.0	38	10
6234230	30 15			15	30	21.0	19.7	12.5	44	10
6234310	30 16			16	30	22.2	21.0	12.5	49	10
6234580	30 17			17	30	23.5	22.3	12.5	57	10
6234660	30 18			18	30	24.7	23.0	12.5	62	10
6234740	30 19			19	30	26.0	23.7	12.5	68	10
6234820	30 20			20	31	27.2	24.5	12.5	78	5
6234900	30 21			21	31	28.5	25.8	13.5	86	5
6235040	30 22			22	32	29.7	26.3	14.5	92	5
2194783	30 24	*		24	33	32.0	28.0	15.5	120	5



Code	No.		Ø AF	L	d ₁	d ₂	t		
6232100	30 1/4AF		1/4	28	10.1	17.5	5.0	23	1
6232290	30 9/32AF		9/32	28	11.1	17.5	5.0	24	1
6232370	30 5/16AF		5/16	28	12.1	17.5	9.0	25	1
6232450	30 11/32AF		11/32	28	13.1	17.5	9.0	25	1
6232530	30 3/8AF		3/8	28	14.1	17.5	9.0	26	1
2101025	30 7/16AF		7/16	28	16.1	17.5	9.0	28	1
2101033	30 1/2AF		1/2	28	18.1	19.2	9.0	35	1
2101041	30 9/16AF		9/16	29	20.1	18.7	11.0	39	1
2101068	30 19/32AF		19/32	30	21.0	19.7	12.5		1
2101076	30 5/8AF		5/8	30	22.1	20.7	12.5	48	1
2101084	30 11/16AF		11/16	30	24.0	22.7	12.5		1
2101092	30 3/4AF		3/4	30	26.0	23.7	12.5	65	1
2101106	30 7/8AF		7/8	32	30.0	26.5	14.5		1

D 30

SOCKET 3/8" bi-hexagon UD profile

- ▲ Acc. to DIN 3124, ISO 2725-1
- ▲ Square drive as per DIN 3120 - C 10, ISO 1174, with ball retention groove
- ▲ Hand-operated, knurled grip
- ▲ GEDORE vanadium steel 31CrV3, polished, chrome-plated
- ▲ * not standardised

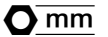
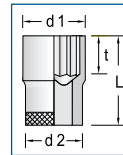

Code	No.	*		Ø mm	L	d ₁	d ₂	t		
1845705	D 30 6	*		6	28	9.7	17.5	5.0	111	10
1845713	D 30 7			7	28	11.0	17.5	5.0	24	10
1845721	D 30 8			8	28	12.1	17.5	9.0	26	10
1845748	D 30 9			9	28	13.5	17.5	9.0	27	10
6229230	D 30 10			10	28	14.7	17.5	9.0	28	10
6230670	D 30 11			11	28	16.0	17.5	9.0	30	5
6230750	D 30 12			12	28	17.2	18.3	9.0	32	5
6230830	D 30 13			13	28	18.5	17.5	9.0	31	10
6230910	D 30 14			14	29	19.7	18.4	11.0	37	5
6231050	D 30 15			15	30	21.0	19.7	12.5	40	5
6231130	D 30 16			16	30	22.2	21.0	12.5	49	5
6231210	D 30 17			17	30	23.5	22.3	12.5	54	10
6231480	D 30 18			18	30	24.7	23.0	12.5	62	5
6231560	D 30 19			19	30	26.0	23.7	12.5	64	10
6231640	D 30 20			20	31	27.2	24.5	12.5	74	5
6231720	D 30 21			21	31	28.5	25.8	13.5	83	5
6231800	D 30 22			22	32	29.7	26.3	14.5	87	5
2194864	D 30 24	*		24	33	32.0	28.0	15.5	100	5



Code	No.		Ø AF	L	d ₁	d ₂	t		
2016613	D 30 1/4AF		1/4	28	10.1	17.5	5.0	50	1
2101009	D 30 9/32AF		9/32	28	11.1	17.5	5.0	20	1
1997122	D 30 5/16AF		5/16	28	12.1	17.5	5.0	20	1
2101017	D 30 11/32AF		11/32	28	13.1	17.5	9.0	26	1
1997130	D 30 3/8AF		3/8	28	14.1	17.5	9.0	10	1
1997149	D 30 13/32AF		13/32	28	15.0	17.5	9.0	30	1
6232610	D 30 7/16AF		7/16	28	16.1	17.5	9.0	27	1
6232880	D 30 1/2AF		1/2	28	18.1	19.2	9.0	34	1
6232960	D 30 9/16AF		9/16	29	20.1	18.7	11.0	36	1
6233180	D 30 19/32AF		19/32	30	21.0	19.7	12.5	39	1
6233260	D 30 5/8AF		5/8	30	22.1	20.7	12.5	44	1
6233340	D 30 11/16AF		11/16	30	24.0	22.7	12.5	53	1
6233420	D 30 3/4AF		3/4	30	26.0	23.7	12.5	61	1
1997157	D 30 25/32AF		25/32	31	27.0	24.3	12.5	75	1
1997165	D 30 13/16AF		13/16	31	28.0	25.3	12.5	80	1
6232020	D 30 7/8AF		7/8	32	30.0	26.5	14.5	82	1
1997173	D 30 15/16AF		15/16	33	31.9	28.0	15.5	110	1
1983296	D 30 1AF		1	33	33.9	30.0	15.5	120	1

www.gedore.com



3/8

D 30 L

SOCKET 3/8" bi-hexagon UD profile, long pattern

- Acc. to DIN 3124, ISO 2725-1
- Square drive as per DIN 3120 - C 10, ISO 1174, with ball retaining groove
- Hand-operated, knurled grip
- GEDORE vanadium steel 31CrV3, polished, chrome-plated

10

3/8

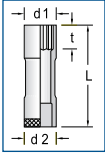

mm

Code	No.	Ø mm	L	d ₁	d ₂	t	↺	↻
6258330	D 30 L 10	10	63.5	14.7	17.5	11	53	10
6258410	D 30 L 11	11	63.5	16.0	17.5	12	54	5
6258680	D 30 L 12	12	63.5	17.2	17.5	14	59	5
6258760	D 30 L 13	13	63.5	18.5	19.0	14	70	10
6258840	D 30 L 14	14	63.5	19.7	19.5	17	76	5
6258920	D 30 L 15	15	63.5	21.0	20.5	17	95	5
6259060	D 30 L 16	16	63.5	22.2	22.0	17	85	5
6259140	D 30 L 17	17	63.5	23.5	20.5	17	96	5
6259220	D 30 L 18	18	63.5	24.7	21.5	20	113	5
6259300	D 30 L 19	19	63.5	26.0	22.0	20	124	5
6259490	D 30 L 20	20	63.5	27.2	23.5	20	127	1
6259570	D 30 L 21	21	63.5	28.5	23.5	20	134	1
6259650	D 30 L 22	22	63.5	29.7	23.5	23	136	1

"AF

Code	No.	Ø "AF	L	d ₁	d ₂	t	↺	↻
6259730	D 30 L 3/8AF	3/8	63.5	14.1	17.5	11	51	1
6259810	D 30 L 7/16AF	7/16	63.5	16.1	17.5	12	53	1
6260070	D 30 L 1/2AF	1/2	63.5	18.1	19.0	14	65	1
6260150	D 30 L 9/16AF	9/16	63.5	20.1	19.5	17	73	1
6260230	D 30 L 5/8AF	5/8	63.5	22.1	22.0	17	92	1
6260310	D 30 L 11/16AF	11/16	63.5	24.0	20.5	17	90	1
6260580	D 30 L 3/4AF	3/4	63.5	26.0	22.0	20	109	1
6260660	D 30 L 13/16AF	13/16	63.5	28.3	23.5	20	132	1
6260740	D 30 L 7/8AF	7/8	63.5	30.0	23.5	23	134	1

TXG 30

SWIVEL HEAD SOCKET 3/8" for protruding TORX® head screws

- Square drive as per DIN 3120 - C 10, ISO 1174, with ball retaining groove
- Hand-operated
- Chrome-vanadium steel 31CrV3, chrome-plated
- TORX® = reg. trademark of Acument Intellectual Properties, LLC. USA

10

3/8

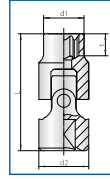

Code	No.	Ø	mm	mm	L	d ₁	d ₂	t	↺	↻
2195321	TXG 30 E8	E8	M6 - M7	7.52	44.5	10.8	19	6.0	45	1
2195348	TXG 30 E10	E10	M8	9.42	44.5	13.2	19	8.5	50	1
2195356	TXG 30 E12	E12	M10	11.17	44.5	15.2	19	8.5	60	1
2195364	TXG 30 E14	E14	M12	12.90	44.5	16.8	19	8.5	60	1

TX 30

SOCKET 3/8" for protruding TORX® head screws

- Square drive as per DIN 3120 - C 10, ISO 1174, with ball retaining groove
- Hand-operated, knurled grip
- GEDORE vanadium steel 31CrV3, polished, chrome-plated
- TORX® = reg. trademark of Acument Intellectual Properties, LLC. USA

10

3/8

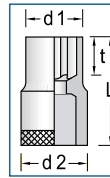

Code	No.	Ø	mm	mm	L	d ₁	d ₂	t	↺	↻
6250270	TX 30 E5	E5	M4	4.73	28	7.2	17.5	5.0	25	5
6250350	TX 30 E6	E6	M5	5.74	28	8.5	17.5	5.0	25	5
6250430	TX 30 E7	E7	M6	6.16	28	9.5	17.5	5.5	25	5
6250510	TX 30 E8	E8	M6 - M7	7.52	28	10.8	17.5	6.0	27	5
6250780	TX 30 E10	E10	M8	9.42	28	13.2	17.5	9.0	29	5
6250860	TX 30 E11	E11	-	10.08	28	13.8	17.5	9.0	30	5
6250940	TX 30 E12	E12	M10	11.17	28	15.2	17.5	9.0	32	5
6251080	TX 30 E14	E14	M12	12.90	28	16.8	18.3	9.0	35	5

DG 30

SWIVEL SOCKET 3/8" UD profile

- Square drive as per DIN 3120 - C 10, ISO 1174, with ball retaining groove
- Hand-operated
- Chrome-vanadium steel 31CrV3, chrome-plated

10

3/8

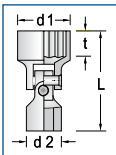

mm

Code	No.	Ø mm	L	d ₁	d ₂	t	↺	↻
6240630	DG 30 10	10	41.5	14.7	19.0	8.0	42	1
6240710	DG 30 11	11	41.5	16.0	19.0	8.0	43	1
6240980	DG 30 12	12	42.5	17.2	19.0	9.0	52	1
6241520	DG 30 13	13	42.5	18.5	19.0	9.0	50	1
6241600	DG 30 14	14	43.5	19.7	19.0	10.0	54	1
6241790	DG 30 15	15	45.5	21.0	19.0	11.0	48	1
6241870	DG 30 16	16	45.5	22.2	19.0	11.0	55	1
6241950	DG 30 17	17	46.0	23.5	19.0	12.0	61	1
6242410	DG 30 18	18	46.0	24.7	19.0	12.5	63	1
6242680	DG 30 19	19	46.5	26.0	19.0	12.5	64	1



1500 ES-30



86



NC 30 • NC 3093 U-10



492

ITX 30

SCREWDRIVER BIT SOCKET 3/8" for recessed TORX® head screws

- ▶ Square drive as per DIN 3120 - C 10, ISO 1174, with ball retaining groove
- ▶ Hand-operated, knurled grip
- ▶ Chrome-plated
- ▶ With pressed-in pin in GEDORE vanadium special steel, gun-metal finish
- ▶ TORX® = reg. trademark of Acument Intellectual Properties, LLC. USA

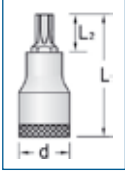

Code	No.	⊕	□ M	★ mm	L ₁	L ₂	d	↻	⊞
6246320	ITX 30 T20	T20	M4 - M5	3.86	49	17	17.5	50	5
6246830	ITX 30 T25	T25	M4,5 - M5	4.43	49	17	17.5	51	5
6247210	ITX 30 T27	T27	M4,5 - M6	4.99	49	17	17.5	51	5
6247560	ITX 30 T30	T30	M6 - M7	5.52	49	17	17.5	51	5
6247720	ITX 30 T40	T40	M7 - M8	6.65	49	17	17.5	52	5
6247800	ITX 30 T45	T45	M8 - M10	7.82	49	17	17.5	53	5
6247990	ITX 30 T50	T50	M10	8.83	49	17	19.0	70	5

ITX 30 L

SCREWDRIVER BIT SOCKET 3/8" for recessed TORX® head screws, long pattern

- ▶ Square drive as per DIN 3120 - C 10, ISO 1174, with ball retaining groove
- ▶ Hand-operated, knurled grip
- ▶ Chrome-plated
- ▶ With pressed-in pin in GEDORE vanadium special steel, gun-metal finish
- ▶ TORX® = reg. trademark of Acument Intellectual Properties, LLC. USA



Code	No.	⊕	□ M	★ mm	L ₁	L ₂	d	↻	⊞
1394177	ITX 30 L T20	T20	M4 - M5	3.86	94	62	17.5	70	5
1394185	ITX 30 L T25	T25	M4,5 - M5	4.43	94	62	17.5	70	5
1394193	ITX 30 L T27	T27	M4,5 - M6	4.99	94	62	17.5	70	5
1394207	ITX 30 L T30	T30	M6 - M7	5.52	94	62	17.5	71	5
1394215	ITX 30 L T40	T40	M7 - M8	6.65	94	62	17.5	70	5
1394223	ITX 30 L T45	T45	M8 - M10	7.82	94	62	17.5	71	5
1394231	ITX 30 L T50	T50	M10	8.83	94	62	19.0	99	5

ITX 30 B

SCREWDRIVER BIT SOCKET 3/8" for recessed TORX® head screws with pilot

- ▶ Square drive as per DIN 3120 - C 10, ISO 1174, with ball retaining groove
- ▶ Hand-operated, knurled grip
- ▶ Chrome-plated
- ▶ With pressed-in pin in GEDORE vanadium special steel, gun-metal finish
- ▶ TORX® = reg. trademark of Acument Intellectual Properties, LLC. USA



Code	No.	⊕	□ M	★ mm	L ₁	L ₂	d	Bore	↻	⊞
1440969	ITX 30 B T20	T20	M4 - M5	3.86	49	17	17.5	1,55 x 1,86	46	5
1440977	ITX 30 B T25	T25	M4,5 - M5	4.43	49	17	17.5	1,93 x 2,04	48	5
1440985	ITX 30 B T27	T27	M4,5 - M6	4.99	49	17	17.5	2,18 x 2,29	48	5
1440993	ITX 30 B T30	T30	M6 - M7	5.52	49	17	17.5	2,56 x 2,92	48	5
1429701	ITX 30 B T40	T40	M7 - M8	6.65	49	17	19.0	2,92 x 3,28	64	5
1441000	ITX 30 B T45	T45	M8 - M10	7.82	49	17	19.0	3,45 x 3,68	66	5
1441019	ITX 30 B T50	T50	M10	8.83	49	17	20.5	3,83 x 3,78	78	5

IS 30

SCREWDRIVER BIT SOCKET 3/8" for slotted head screws

- ▶ Square drive as per DIN 3120 - C 10, ISO 1174, with ball retaining groove
- ▶ Hand-operated, knurled grip
- ▶ Chrome-plated
- ▶ With pressed-in pin in GEDORE vanadium special steel, manganese-phosphated
- ▶ Blade as per DIN ISO 2380-1, Form B

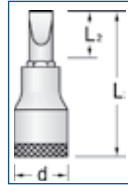

Code	No.	mm ±	mm ±	L ₁	L ₂	d	↻	⊞
6666100	IS 30 5,5x1	1.0	5.5	55	27	17.5	40	5
1640895	IS 30 6,5x1,2	1.2	6.5	55	27	17.5	39	1
6666290	IS 30 8x1,2	1.2	8.0	55	23	17.5	54	5
6666370	IS 30 10x1,6	1.6	10.0	55	23	19.0	72	5
1640909	IS 30 12x2	2.0	12.0	55	23	20.5	83	1

IKS 30

SCREWDRIVER BIT SOCKET 3/8" for cross-slotted head screws PH

- ▶ Square drive as per DIN 3120 - C 10, ISO 1174, with ball retaining groove
- ▶ Hand-operated, knurled grip
- ▶ Chrome-plated
- ▶ With pressed-in pin in GEDORE vanadium special steel, gun-metal finish
- ▶ Tip as per DIN ISO 8764-1 PH

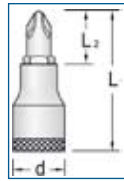
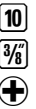

Code	No.	⊕ PH	L ₁	L ₂	d	↻	⊞
6666610	IKS 30 1	1	55	27	17.5	41	5
6666880	IKS 30 2	2	55	23	17.5	52	5
6666960	IKS 30 3	3	55	23	19.0	70	5

IKS 30 PZD

SCREWDRIVER BIT SOCKET 3/8" for cross-slotted head screws PZ

- ▶ Square drive as per DIN 3120 - C 10, ISO 1174, with ball retaining groove
- ▶ Hand-operated, knurled grip
- ▶ Chrome-plated
- ▶ With pressed-in pin in GEDORE vanadium special steel, gun-metal finish
- ▶ Tip as per DIN ISO 8764-1 PH

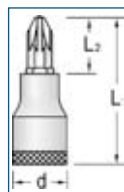

Code	No.	⊕ PZ	L ₁	L ₂	d	↻	⊞
1640968	IKS 30 PZD 1	1	55	27	17.5	40	1
1640976	IKS 30 PZD 2	2	55	23	17.5	51	1
1640984	IKS 30 PZD 3	3	55	23	19.0	69	1

IN 30

SCREWDRIVER BIT SOCKET 3/8" for in-hex screws METRIC

- Acc. to DIN 7422
- Square drive as per DIN 3120 - C 10, ISO 1174, with ball retaining groove
- Hand-operated, knurled grip
- Chrome-plated
- With pressed-in pin in GEDORE vanadium special steel, manganese-phosphated
- * not standardised

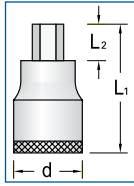

mm

Code	No.	*	mm	L ₁	L ₂	d		
6241010	IN 30 4		4	47	19	17.5	38	10
6241280	IN 30 5		5	47	19	17.5	39	10
6241360	IN 30 6		6	47	19	17.5	41	10
1643037	IN 30 7	*	7	47	19	17.5	41	1
6241440	IN 30 8		8	49	17	17.5	53	10
6242920	IN 30 10		10	49	17	19.0	73	10



Code	No.		AF	L ₁	L ₂	d		
2195208	IN 30 1/8AF		1/8	47	19	17.5		1
2195232	IN 30 5/32AF		5/32	47	19	17.5		1
2195267	IN 30 3/16AF		3/16	47	19	17.5	40	1
1193422	IN 30 1/4AF		1/4	47	19	17.5	49	1
1193431	IN 30 5/16AF		5/16	49	17	17.5	54	1
1193449	IN 30 3/8AF		3/8	49	17	19.0	50	1



IN 30 L

SCREWDRIVER BIT SOCKET 3/8" for in-hex screws, long pattern

- Acc. to DIN 7422
- Square drive as per DIN 3120 - C 10, ISO 1174, with ball retaining groove
- Hand-operated, knurled grip
- Chrome-plated
- With pressed-in pin in GEDORE vanadium special steel, manganese-phosphated

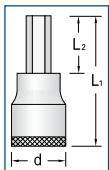

mm

Code	No.	mm	L ₁	L ₂	d		
1510118	IN 30 L 4-95	4	95	67	17.5	44	10
1394347	IN 30 L 5-95	5	95	67	17.5	48	10
1394355	IN 30 L 6-95	6	95	67	17.5	53	10
1394363	IN 30 L 7-95	7	95	67	17.5	58	10
1394371	IN 30 L 8-95	8	95	63	17.5	74	10
1394398	IN 30 L 10-95	10	95	63	19.0	105	10

IN 30 LK

SCREWDRIVER BIT SOCKET 3/8" with ball end, for in-hex screws, long pattern

- Square drive as per DIN 3120 - C 10, ISO 1174, with ball retaining groove
- Hand-operated, knurled grip
- Chrome-plated
- With pressed-in pin in GEDORE vanadium special steel, gun-metal finish
- Total swivel angle approx. 15-20°

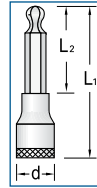
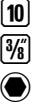

mm

Code	No.	mm	L ₁	L ₂	d		
1505718	IN 30 LK 4	4	132	104	17.5	48	10
1505726	IN 30 LK 5	5	132	104	17.5	54	10
1505742	IN 30 LK 6	6	132	104	17.5	61	10
1505750	IN 30 LK 8	8	134	102	17.5	91	10
1505769	IN 30 LK 10	10	134	102	19.0	130	10

INX 30

SCREWDRIVER BIT SOCKET 3/8" for multi-point screws XZN

- Acc. to DIN 2324
- Square drive as per DIN 3120 - C 10, ISO 1174, with ball retaining groove
- Hand-operated, knurled grip
- Chrome-plated
- With pressed-in pin in GEDORE vanadium special steel, manganese-phosphated
- Tip as per DIN 2325

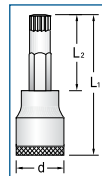

Code	No.		L ₁	L ₂	d		
6242170	INX 30 5	M5	49	17	17.5	50	5
6242250	INX 30 6	M6	49	17	17.5	51	5
6242330	INX 30 8	M8	49	17	17.5	53	5
2194872	INX 30 10	M10	49	17	19.0	78	5

INX 30 L

SCREWDRIVER BIT SOCKET 3/8" for multi-point screws XZN, long pattern

- Acc. to DIN 2324
- Square drive as per DIN 3120 - C 10, ISO 1174, with ball retaining groove
- Hand-operated, knurled grip
- Chrome-plated
- With pressed-in pin in GEDORE vanadium special steel, manganese-phosphated
- Tip as per DIN 2325

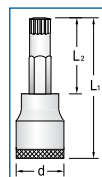

Code	No.		L ₁	L ₂	d		
1394312	INX 30 L 6	M6	94	62	17.5	68	5
1394320	INX 30 L 8	M8	94	62	17.5	71	5
1394339	INX 30 L 10	M10	94	62	19.0	79	5

ACCESSORIES 10 MM (3/8")

3019

CONVERTOR 3/8" TO 1/2"

- Acc. to DIN 3123, ISO 3316
- For hand-operated sockets and accessories with square drive as per DIN 3120, ISO 1174, with ball locking device
- GEDORE vanadium steel 31CrV3, polished, chrome-plated

10
3/8"
12.5
1/2"



Code	No.	□"	□	■"	■	↳mm↳	↳mm↳	↳mm↳
6236010	3019	3/8	10	1/2	12.5	35	53	10

3020

REDUCER 3/8" TO 1/4"

- Acc. to DIN 3123, ISO 3316
- For hand-operated sockets and accessories with square drive as per DIN 3120, ISO 1174, with ball locking device
- GEDORE vanadium steel 31CrV3, polished, chrome-plated

10
3/8"
6.3
1/4"



Code	No.	□"	□	■"	■	↳mm↳	↳mm↳	↳mm↳
6236280	3020	3/8	10	1/4	6.3	28.5	26	10

3081

L-HANDLE 3/8"

- Acc. to DIN 3122, ISO 3315
- For hand-operated sockets and accessories with square drive as per DIN 3120, ISO 1174, with ball locking device
- GEDORE vanadium steel 31CrV3, polished, chrome-plated

10
3/8"



Code	No.	■"	■	↳mm↳	↳mm↳	↳mm↳
6236360	3081	3/8	10	180	153	1

3084

SPEED BRACE 3/8"

- Acc. to DIN 3122, ISO 3315
- For hand-operated sockets and accessories with square drive as per DIN 3120, ISO 1174, with ball locking device
- GEDORE vanadium steel 31CrV3, polished, chrome-plated

10
3/8"

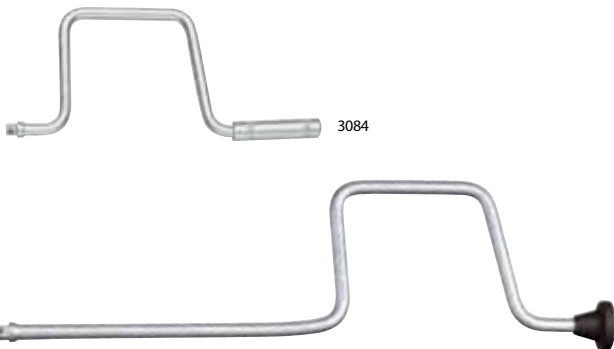

Code	No.	■"	■	↳mm↳	↳mm↳	↳mm↳
6236440	3084	3/8	10	288	423	1
1965395	3084 L	3/8	10	463	568	1

3087

SLIDING T BAR 3/8"

- Acc. to DIN 3122, ISO 3315
- For hand-operated sockets and accessories with square drive as per DIN 3120, ISO 1174, with ball locking device
- GEDORE vanadium steel 31CrV3, polished, chrome-plated

10
3/8"



Code	No.	■"	■	↳mm↳	↳mm↳	↳mm↳
6236520	3087	3/8	10	163	164	5

3087 A

SLIDING T BAR WITH RELEASE 3/8"

- Secured against unintentional removal
- GEDORE vanadium steel 31CrV3, polished, chrome-plated
- Turn handle for easy locking and releasing
- Accidental release when working is prevented because of the asymmetrical release point
- Particularly useful for work in sensitive areas where certainty against loss is a theme
- Examples: Aircraft engine, work in deep machine bodies
- DBGM

10
3/8"



Code	No.	■"	■	↳mm↳	↳mm↳	↳mm↳
1871633	3087 A	3/8	10	163	135	1

3090

EXTENSION 3/8"

- Acc. to DIN 3123, ISO 3316
- For hand-operated sockets and accessories with square drive as per DIN 3120, ISO 1174, with ball locking device
- GEDORE vanadium steel 31CrV3, polished, chrome-plated
- * not standardised

10
3/8"

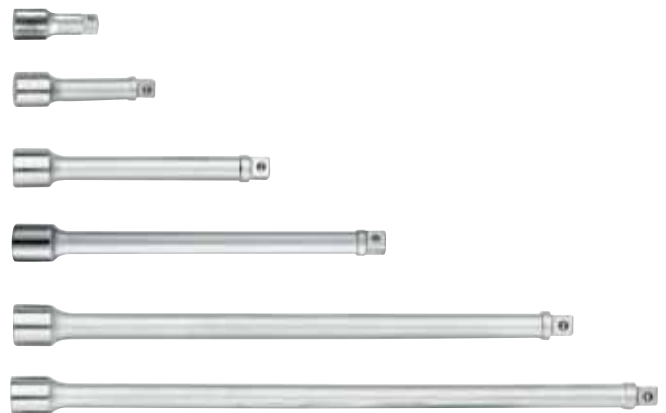

Code	No.	*	■"	■	↳mm↳	↳mm↳	↳mm↳
1476637	3090-2	*	3/8	10	50	63	5
6236600	3090-3		3/8	10	76	93	5
6236790	3090-5		3/8	10	125	117	5
1476645	3090-7	*	3/8	10	180	164	5
6236870	3090-10		3/8	10	250	222	5
6238570	3090-12	*	3/8	10	305	287	5
1476653	3090-20	*	3/8	10	500	524	1

3090 A

EXTENSION 3/8" with release

- Easy access to deep-fitting screws in confined areas
- No unintentional release of the socket from the extension due to safety ring
- For hand-operated sockets and accessories with square drive as per DIN 3120, ISO 1174, with ball locking device

10
3/8"



Code	No.	3/8"	10	(mm)		
1932314	3090 A-5	3/8	10	125	120	1
1932322	3090 A-10	3/8	10	250	210	1

3090 KR

UNIVERSAL EXTENSION 3/8"

- With ball end
- For hand-operated sockets with square drive as per DIN 3120, ISO 1174, with ball locking device
- The extension is able to pivot up to 15°
- GEDORE vanadium steel 31CrV3, polished, chrome-plated

10
3/8"



Code	No.	3/8"	10	(mm)		
1874381	3090 KR-3	3/8	10	76	80	1
1845756	3090 KR-5	3/8	10	125	108	1
1845764	3090 KR-10	3/8	10	250	197	1

3094

COUPLER 3/8"

- Acc. to DIN 3122, ISO 3316
- For hand-operated sockets and accessories with square drive as per DIN 3120, ISO 1174, with ball locking device
- GEDORE vanadium steel 31CrV3, polished, chrome-plated

10
3/8"



Code	No.	3/8"	10	(mm)		
6237760	3094	3/8	10	28.8	20	10

3095

UNIVERSAL JOINT 3/8"

- Acc. to DIN 3123, ISO 3316
- For hand-operated sockets and accessories with square drive as per DIN 3120, ISO 1174, with ball locking device
- GEDORE vanadium steel 31CrV3, polished, chrome-plated

10
3/8"



Code	No.	3/8"	10	3/8"	10	(mm)		
6238140	3095	3/8	10	3/8	10	50	53	10

3096

SWIVEL HANDLE 3/8"

- Acc. to DIN 3122, ISO 3315
- For hand-operated sockets and accessories with square drive as per DIN 3120, ISO 1174, with ball locking device
- GEDORE vanadium steel 31CrV3, polished, chrome-plated

10
3/8"



Code	No.	3/8"	10	(mm)		
6238220	3096	3/8	10	254	201	5

3098

SWIVEL HANDLE 3/8"

- For hand-operated sockets and accessories with square drive as per DIN 3120, ISO 1174, with ball locking device
- GEDORE vanadium steel 31CrV3, polished, chrome-plated

10
3/8"



Code	No.	3/8"	10	(mm)		
6182410	3098	3/8	10	450	364	1



SL 3014

TOOL HOLDING RAIL, MAGNETIC 3/8" empty

- External squares to take 14 standard commercial 10 mm (3/8") sockets
- Two female square adaptors to take ratchets, sliding T bars, extensions etc.
- A strong magnet securely holds the socket rail to ferrous metals
- Additional holes are provided for wall mounting the socket rail or attaching to non-ferrous materials
- The sockets are securely locked by the ball at the square-drive end by turning them 90°
- It is a simple matter to "unlock" and remove the sockets, by turning them 90° in the opposing direction
- Delivery without tools

10
3/8"
10
3/8"



Code	No.	(mm)	mm		
1761099	SL 3014	480	33	479	1

VH 30

SPRING STEEL SOCKET RAIL 3/8"

- For 14 3/8" sockets
- Delivery without tools

10
3/8"



Code	No.			
5164810	VH 30	67		1

S 2032-05



157

SETS 10 MM (3/8") METRIC

www.gedore.com

30 DMU / D 30 DMU

SOCKET SET 3/8" 12 pieces

- ✔ With forged, tempered hexagon (no. 30) or UD profile sockets (no. D 30), hand-operated
- ✔ With accessories made from GEDORE vanadium steel 31CrV3
- ✔ With reversible with lever change ratchet
- ✔ In GEDORIT blue sheet steel case
- ✔ Dimensions: 206 x 62 x 40 mm



mm

Code	No.	Ratchet	Sockets	Accessories		
6235200	30 DMU-10	U-10 3093 U-10	30 6 7 8 9 10 11 13 14 17 19	3090-5	1.0	1
6238730	D 30 DMU-10	U-10 3093 U-10	D 30 6 7 8 9 10 11 13 14 17 19	3090-5	1.0	1

30 GMU / D 30 GMU

SOCKET SET 3/8" 17 pieces

- ✔ With forged, tempered hexagon (no. 30) or UD profile sockets (no. D 30), hand-operated
- ✔ With accessories made from GEDORE vanadium steel 31CrV3
- ✔ Set U-3 with fine toothed, dial change ratchet
- ✔ Set U-10 with reversible with lever change ratchet
- ✔ In GEDORIT blue sheet steel case
- ✔ Dimensions: 320 x 210 x 55 mm



mm

Code	No.	Ratchet	Sockets	Accessories		
6235980	30 GMU-3	U-3 3093 U-3	30 6 7 8 9 10 11 13 14 15 16 17 19	3087 3090-5 -10 3095	1.8	1
6235710	30 GMU-10	U-10 3093 U-10	30 6 7 8 9 10 11 13 14 15 16 17 19	3087 3090-5 -10 3095	1.9	1
6240200	D 30 GMU-3	U-3 3093 U-3	D 30 6 7 8 9 10 11 13 14 15 16 17 19	3087 3090-5 -10 3095	1.8	1
6239380	D 30 GMU-10	U-10 3093 U-10	D 30 6 7 8 9 10 11 13 14 15 16 17 19	3087 3090-5 -10 3095	1.8	1



3/8"



The GEDORE socket set

- ▶ Innovative, functional design
- ▶ Sheet steel case - inside-folded, seamless edge provides added strength. The tool and foam inserts are secured to prevent them being lost
- ▶ ABS plastic tool insert, resistant to oils and greases
- ▶ Tool insert with the socket sizes permanently laser marked
- ▶ With the lid closed, the tools sit securely in their pockets
- ▶ Boxes designed so that they can be stacked easily
- ▶ Large, rounded fasteners can be opened and closed even when the user is wearing gloves
- ▶ Contoured carry handle ensures comfortable carrying even for long periods
- ▶ Environmentally-friendly powder-coated in GEDORIT blue



3/8"



30 HMU / D 30 HMU

SOCKET SET 3/8" 23 pieces

- ▶ With forged, tempered hexagon (no. 30) or UD profile sockets (no. D 30), hand-operated
- ▶ With accessories made from GEDORE vanadium steel 31CrV3
- ▶ Set U-3 with fine toothed, dial change ratchet
- ▶ Set U-10 with reversible with lever change ratchet
- ▶ In GEDORIT blue sheet steel case
- ▶ Dimensions: 320 x 210 x 55 mm

10

3/8"



mm

Code	No.	Ratchet	Sockets	Accessories	mm	mm
6238300	30 HMU-3	● U-3 3093 U-3	☉ 30 6 7 8 9 10 11 12 13 14 15 16 17 18 19 20 21 22	3087 3090-5 -10 3095	2.7	1
6235470	30 HMU-10	☉ U-10 3093 U-10	☉ 30 6 7 8 9 10 11 12 13 14 15 16 17 18 19 20 21 22	3087 3090-5 -10 3095	2.7	1
6240470	D 30 HMU-3	● U-3 3093 U-3	☉ D 30 6 7 8 9 10 11 12 13 14 15 16 17 18 19 20 21 22	3087 3090-5 -10 3095	2.7	1
6239700	D 30 HMU-10	☉ U-10 3093 U-10	☉ D 30 6 7 8 9 10 11 12 13 14 15 16 17 18 19 20 21 22	3087 3090-5 -10 3095	2.7	1



30 QMU / D 30 QMU

SOCKET SET 3/8" 35 pieces

- With forged, tempered hexagon (no. 30) or UD profile sockets (no. D 30), hand-operated
- With accessories made from GEDORE vanadium steel 31CrV3
- Set U-3 with fine toothed, dial change ratchet
- Set U-10 with reversible with lever change ratchet
- In GEDORIT blue sheet steel case
- Dimensions: 315 x 181 x 40 mm



mm

Code	No.	Ratchet	Sockets	Accessories	mm	mm
6238490	30 QMU-3	U-3 3093 U-3	30 6 7 8 9 10 11 12 13 14 15 16 17 18 19 20 21 22 880 6,5 7 8 885 3 4 5 6 8 890 1 2 3	3087 3090-5 -10 3095 870 KB 830	3.0	1
6235630	30 QMU-10	U-10 3093 U-10	30 6 7 8 9 10 11 12 13 14 15 16 17 18 19 20 21 22 880 6,5 7 8 885 3 4 5 6 8 890 1 2 3	3087 3090-5 -10 3095 870 KB 830	3.0	1
6240550	D 30 QMU-3	U-3 3093 U-3	D 30 6 7 8 9 10 11 12 13 14 15 16 17 18 19 20 21 22 880 6,5 7 8 885 3 4 5 6 8 890 1 2 3	3087 3090-5 -10 3095 870 KB 830	2.9	1
6239970	D 30 QMU-10	U-10 3093 U-10	D 30 6 7 8 9 10 11 12 13 14 15 16 17 18 19 20 21 22 880 6,5 7 8 885 3 4 5 6 8 890 1 2 3	3087 3090-5 -10 3095 870 KB 830	2.9	1

30 IMU / D 30 IMU

SOCKET SET 3/8" 26 pieces

- With forged, tempered hexagon (no. 30) or UD profile sockets (no. D 30), hand-operated
- With accessories made from GEDORE vanadium steel 31CrV3
- Set U-3 with fine toothed, dial change ratchet
- Set U-10 with reversible with lever change ratchet
- In GEDORIT blue sheet steel case
- Dimensions: 320 x 210 x 55 mm



mm

Code	No.	Ratchet	Sockets	Accessories	mm	mm
6229900	30 IMU-3	U-3 3093 U-3	30 6 7 8 9 10 11 12 13 14 15 16 17 19 IS 30 5,5 8 IN 30 4 5 6 8 IKS 30 2 3	3087 3090-5 -10 3095	2.5	1
6229740	30 IMU-10	U-10 3093 U-10	30 6 7 8 9 10 11 12 13 14 15 16 17 19 IS 30 5,5 8 IN 30 4 5 6 8 IKS 30 2 3	3087 3090-5 -10 3095	2.5	1
6230080	D 30 IMU-3	U-3 3093 U-3	D 30 6 7 8 9 10 11 12 13 14 15 16 17 19 IS 30 5,5 8 IN 30 4 5 6 8 IKS 30 2 3	3087 3090-5 -10 3095	2.5	1
6229820	D 30 IMU-10	U-10 3093 U-10	D 30 6 7 8 9 10 11 12 13 14 15 16 17 19 IS 30 5,5 8 IN 30 4 5 6 8 IKS 30 2 3	3087 3090-5 -10 3095	2.5	1



3/8"

D 30 KMU-20

SOCKET SET 3/8" 40 pieces

- With forged, tempered UD profile sockets, hand-operated
- With accessories made from GEDORE vanadium steel 31CrV3
- With robust lever-change reversible ratchet with push-button release
- In sheet steel case with insert
- Dimensions: 320 x 210 x 55 mm
- TORX® = reg. trademark of Acument Intellectual Properties, LLC. USA

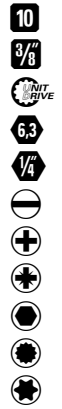

mm

Code	No.	Ratchet	Sockets	Accessories		
1973347	D 30 KMU-20	U-20 3093 U-20 3093 U-3 T	D 30 8 9 10 11 12 13 14 15 16 17 18 19 680 4 5,5 6,5 685 3 4 5 6 685 X 5 6 8 687 TX T10 T15 T20 T25 T27 T30 690 1 2 690 PZD 1 2	3090 KR-3 3090-5 630 673 10 676 699	1.8	1

D 30 TX20 U-20

SOCKET SET 3/8" + 1/4" 52 pieces

- Tool set for general industrial and automotive applications
- 3/8" and 1/4" sockets for protruding and recessed TORX® screws
- With robust lever-change reversible ratchet with push-button release
- In sheet steel case with Check-Tool insert
- Dimensions: 320 x 210 x 55 mm
- TORX® = reg. trademark of Acument Intellectual Properties, LLC. USA



mm

Code	No.	Ratchet	Sockets	Accessories		
2075695	D 30 TX20 U-20	U-20 3093 U-20 U-20 2093 U-20	D 30 10 11 12 13 14 15 16 17 18 19 21 22 TX 30 E11 E12 E14 ITX 30 T45 T50 D 20 4 4,5 5 5,5 6 7 8 9 10 11 12 13 TX 20 E5 E6 E7 E8 E10 687 TX T10 T15 T20 T25 T27 T30 T40	3090 KR-3 3090-5 2090 KR-2 2090-6 620 673 6,3 10 676 699	3.2	1



IN 30 LKM

SCREWDRIVER BIT SOCKET SET 3/8" 10 pieces

- For in-hex screws (INBUS®), short and long
- In plastic case
- Dimensions: 200 x 120 x 38 mm
- INBUS® = reg. trademark of Acument GmbH & Co. OHG, 56567 Neuwied



Code	No.	Sockets		
1509918	IN 30 LKM	<ul style="list-style-type: none"> IN 30 4 5 6 8 10 IN 30 L 4 5 6 8 10 	761	1

ITX 30 PM

SCREWDRIVER BIT SOCKET SET 3/8" 7 pieces

- For recessed TORX® screws
- In blue sheet steel case
- Dimensions: 210 x 70 x 32 mm
- TORX® = reg. trademark of Acument Intellectual Properties, LLC. USA

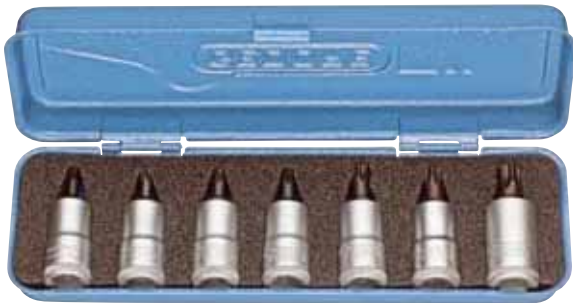

Code	No.	Sockets		
1509926	ITX 30 PM	ITX 30 T20 T25 T27 T30 T40 T45 T50	627	1

ITX 30 LKP

SCREWDRIVER BIT SOCKET SET 3/8" 14 pieces

- For recessed TORX® screws, short and long
- In plastic case
- Dimensions: 200 x 120 x 38 mm
- TORX® = reg. trademark of Acument Intellectual Properties, LLC. USA



Code	No.	Sockets		
1509950	ITX 30 LKP	<ul style="list-style-type: none"> ITX 30 T20 T25 T27 T30 T40 T45 T50 ITX 30 L T20 T25 T27 T30 T40 T45 T50 	1081	1

ITX 30 TX-015

SCREWDRIVER BIT SOCKET SET 3/8" 15 pieces

- For protruding and recessed TORX® screws
- In plastic case
- Dimensions: 200 x 120 x 38 mm
- TORX® = reg. trademark of Acument Intellectual Properties, LLC. USA



Code	No.	Sockets		
1509942	ITX 30 TX-015	<ul style="list-style-type: none"> ITX 30 T20 T25 T27 T30 T40 T45 T50 TX 30 E5 E6 E7 E8 E10 E11 E12 E14 	801	1

TX 30 E-08

SOCKET SET 3/8" 8 pieces

- For protruding TORX® screws
- In GEDORIT blue sheet steel case
- Dimensions: 210 x 70 x 32 mm
- TORX® = reg. trademark of Acument Intellectual Properties, LLC. USA

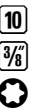

Code	No.	Sockets		
1509934	TX 30 E-08	TX 30 E5 E6 E7 E8 E10 E11 E12 E14	485	1

30 TX 20

SCREWDRIVER BIT SOCKET SET 3/8" + 1/4" 28 pieces

- 3/8" and 1/4" sockets for protruding and recessed TORX® screws
- In plastic case
- Dimensions: 275 x 150 x 42 mm
- TORX® = reg. trademark of Acument Intellectual Properties, LLC. USA

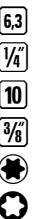

Code	No.	Sockets		
1509969	30 TX 20	<ul style="list-style-type: none"> ITX 30 T25 T27 T30 T40 T45 T50 ITX 30 L T20 T25 T27 T30 T40 T45 T50 TX 30 E8 E10 E11 E12 E14 ITX 20 T8 T9 T10 T15 T20 TX 20 E4 E5 E6 E7 2030 	1484	1

VB 30 / VBD 30

DISPLAY BOX 3/8" 228 pieces

- With 228 3/8" sockets
- Display box empty (VB 30 L) in GEDORIT silver sheet steel
- Dimensions: 430 x 300 x 220 mm

Code	No.	Sockets	Weight	Units
6233500	VB 30	S VB 30 + VB 30 L	10.4	1
1888072	S VB 30	12x D 30 10 13 10x D 30 6 7 8 9 8x D 30 11 12 14 15 17 19 5x D 30 16 18 20 21 22 10x IN 30 5 8x IN 30 4 6 5x IN 30 8 10 5x IS 30 5,5 8 10 5x IKS 30 1 2 3 5x INX 30 5 6 8 10x 3019	12.0	1
6233690	VBD 30	S VBD 30 + VB 30 L	16.0	1
1888080	S VBD 30	12x D 30 10 13 10x D 30 6 7 8 9 8x D 30 11 12 14 15 17 19 5x D 30 16 18 20 21 22 10x IN 30 5 8x IN 30 4 6 5x IN 30 8 10 5x IS 30 5,5 8 10 5x IKS 30 1 2 3 5x INX 30 5 6 8 10x 3019	12.0	1
5231940	VB 30 L		6.4	1



SETS 10 MM (3/8") INCH

D 30 DAU

SOCKET SET 3/8" 12 pieces

- With forged, tempered UD profile, hand-operated sockets
- With accessories made from GEDORE vanadium steel 31CrV3
- With reversible with lever change ratchet
- In GEDORIT blue sheet steel case
- Dimensions: 206 x 62 x 40 mm



Code	No.	Ratchet	Sockets	Accessories	Weight	Units
6239030	D 30 DAU-10	3093 U-10	D 30 1/4 5/16 11/32 3/8 7/16 1/2 9/16 5/8 11/16 3/4"	3090-5	1.0	1

D 30 GAU

SOCKET SET 3/8" 17 pieces

- With forged, tempered UD profile, hand-operated sockets
- With accessories made from GEDORE vanadium steel 31CrV3
- Set U-3 with fine toothed, dial change ratchet
- Set U-10 with reversible with lever change ratchet
- In GEDORIT blue sheet steel case
- Dimensions: 320 x 210 x 55 mm

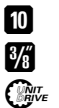

Code	No.	Ratchet	Sockets	Accessories	Weight	Units
6240390	D 30 GAU-3	3093 U-3	D 30 1/4 9/32 5/16 11/32 3/8 7/16 1/2 9/16 19/32 5/8 11/16 3/4"	3087 3090-5 -10 3095	1.8	1
6239540	D 30 GAU-10	3093 U-10	D 30 1/4 9/32 5/16 11/32 3/8 7/16 1/2 9/16 19/32 5/8 11/16 3/4"	3087 3090-5 -10 3095	1.8	1

12.5 MM (1/2") SQUARE DRIVE

12.5 1/2" 12.5 1/2"

RATCHETS 12.5 MM (1/2")

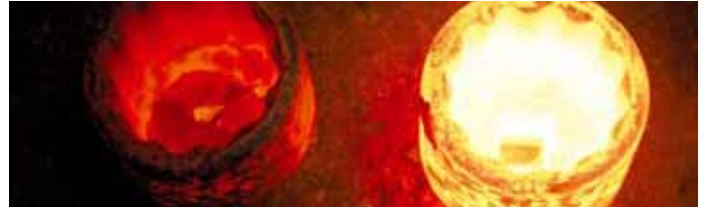

1993 U-20

REVERSIBLE RATCHET 1/2"

- ✔ Acc. to DIN 3122, ISO 3315
- ✔ Small, drop shaped head for confined areas
- ✔ Fine-toothed, with lever change and push-button release
- ✔ Non-slip 2-component handle with hanging hole
- ✔ For hand-operated sockets and accessories with square drive as per DIN 3120 - C 12.5, ISO 1174, ball locking device
- ✔ GEDORE vanadium steel 31CrV3, chrome-plated

12.5
1/2"



1/2"

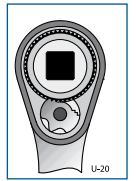

Code	No.	□"	■	↙°	↔mm↔	↔	↕	📦
1436686	1993 U-20	1/2	12.5	6	270	37.5	536	5

1993 U-10 L

REVERSIBLE RATCHET 1/2" long pattern

- ✔ Acc. to DIN 3122, ISO 3315
- ✔ With lever change
- ✔ Push-button release
- ✔ Locks in the middle position: When the lever is flipped, it automatically engages for clockwise or counterclockwise operation
- ✔ For hand-operated sockets and accessories with square drive as per DIN 3120 - C 12.5, ISO 1174, ball locking device
- ✔ GEDORE vanadium steel 31CrV3, chrome-plated

12.5
1/2"



Code	No.	□"	■	↙°	↔mm↔	↔	↕	📦
6154550	1993 U-10 L	1/2	12.5	11,25	350	41	696	5

1993 U-10 T

REVERSIBLE RATCHET 1/2"

- ✔ Acc. to DIN 3122, ISO 3315
- ✔ With recessed lever change
- ✔ Push-button release
- ✔ Locks in the middle position: When the lever is flipped, it automatically engages for clockwise or counterclockwise operation
- ✔ For hand-operated sockets and accessories with square drive as per DIN 3120 - C 12.5, ISO 1174, ball locking device
- ✔ GEDORE vanadium steel 31CrV3, chrome-plated

12.5
1/2"



Code	No.	□"	■	↙°	↔mm↔	↔	↕	📦
6142620	1993 U-10 T	1/2	12.5	11,25	270	39	598	5

1993 ALU-10

ALUMINIUM REVERSIBLE RATCHET 1/2"

- Design spec. similar to DIN 3122, ISO 3315
- Made from special-purpose drop-forged and hardened aluminium
- The mechanism as in all U-10 ratchets is made from high-quality steel
- With lever change
- Push-button release
- Locks in the middle position: When the lever is flipped, it automatically engages for clockwise or counterclockwise operation
- For hand-operated sockets and accessories with square drive as per DIN 3120 - C 12.5, ISO 1174, ball locking device
- Extremely lightweight - just 350 g



12,5
1/2"

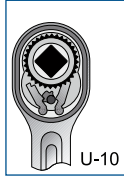

Code	No.	□"	■	∠°	↳mm↳	↳	↳	↳
6142700	1993 ALU-10	1/2	12.5	11,25	270	39	349	5



1/2"

1993 U-3

REVERSIBLE RATCHET 1/2"

- Acc. to DIN 3122, ISO 3315
- With non-slip metal disc change, fine-toothed and robust
- For hand-operated sockets and accessories with square drive as per DIN 3120 - C 12.5, ISO 1174, ball locking device
- GEDORE vanadium steel 31CrV3, chrome-plated

12,5
1/2"

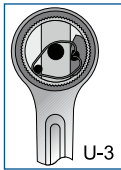

Code	No.	□"	■	∠°	↳mm↳	↳	↳	↳
6144240	1993 U-3	1/2	12.5	5	270	40.5	476	5

1993 GU-10 XL

SWIVEL HEAD REVERSIBLE RATCHET 1/2" extra long

- Ideal for the truck and/or industrial vehicle sectors
- Swivels through 180°
- With lever change
- Push-button release
- Especially suitable for high torques, max. torque 600 N-m
- Locks in the middle position: When the lever is flipped, it automatically engages for clockwise or counterclockwise operation
- For hand-operated sockets and accessories with square drive as per DIN 3120 - C 12.5, ISO 1174, ball locking device
- GEDORE vanadium steel 31CrV3, chrome-plated

12,5
1/2"

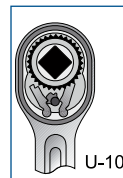

Code	No.	□"	■	∠°	↳mm↳	↳
2018934	1993 GU-10 XL	1/2	12.5	11,25	600	1160

VDE 1993 U



505



NC 1993 U-10



493



1940



186



1993 GU-3

SWIVEL HEAD REVERSIBLE RATCHET 1/2"

- Swivels through 180°, with joint lock
- With non-slip metal disc change, fine-toothed and robust
- Max. torque 300 N-m
- For hand-operated sockets and accessories with square drive as per DIN 3120 - C 12.5, ISO 1174, ball locking device
- GEDORE vanadium steel 31CrV3, chrome-plated

12,5
1/2"



Code	No.	1/2"	12.5	5	282	40.5	535	5
6144320	1993 GU-3	1/2	12.5	5	282	40.5	535	5

1993 U-10 K

PLASTIC RATCHET 1/2"

- For fast and easy tightening of bolted connections up to max. 70 N-m
- Very handy and compact, housing and handle form one unit
- Return angle 11,25°
- Made from sturdy compound material with a steel mechanism
- Dimensions: 44 x 145 x 42.2 mm
- Available in five colours
- European-Patent-No. 1136187

12,5
1/2"

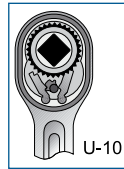

Code	No.	Colour	1/2"	12.5	145	11,25	226	5
6242760	1993 U-10 K SCHWARZ	signal-black	1/2	12.5	145	11,25	226	5
6244620	1993 U-10 K GRÜN	moss-green	1/2	12.5	145	11,25	226	1
6244700	1993 U-10 K GRAU	anthracite-grey	1/2	12.5	145	11,25	226	1
6244890	1993 U-10 K BLAU	sky-blue	1/2	12.5	145	11,25	226	1
1505025	1993 U-10 K SIGNALGRAU	signal-grey	1/2	12.5	145	11,25	226	5

1993 Z-94

RATCHET HANDLE WITH COUPLER 1/2"

- Acc. to DIN 3122, ISO 3315
- With square coupler, medium-fine toothed, extremely rugged
- For hand-operated sockets and accessories with square drive as per DIN 3120 - C 12.5, ISO 1174 ball locking device
- GEDORE vanadium steel 31CrV3, chrome-plated

12,5
1/2"

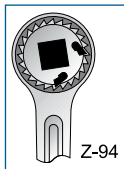

Code	No.	1/2"	12.5	15	270	21.9	476	5
6144590	1993 Z-94	1/2	12.5	15	270	21.9	476	5



VS 1930

DISPLAY STAND 1/2" for plastic ratchets

- Display stand for 20 plastic ratchets in four different colours
- In sturdy wire and sheet metal design
- Contents:
 - 16 pieces 1993 U-10 K (4 each sky-blue RAL 5015, black RAL 9004, signal-grey RAL 7004, moss-green RAL 6005)
 - 4 pieces 3093 U-10 K (1 each sky-blue RAL 5015, black RAL 9004, signal-grey RAL 7004, moss-green RAL 6005)

10
3/8
12.5
1/2



Code	No.	Description		
1461621	VS 1930 U-10 K	Display stand with assortment	6.0	1
1464175	VS 1930 U-10 K L	Display stand empty	1.1	1



i **S 1023 M**

72

i **1000**

58

1/2"	UNIT DRIVE hexagon	UNIT DRIVE bi-hexagon	UNIT DRIVE bi-hexagon	UNIT DRIVE hexagon	UNIT DRIVE bi-hexagon	Hexagon - external	Hexagon - external	Hexagon - external	Internal hexagon	Internal TORX®	Internal TORX® with pin	External TORX®	Internal serrations XZN	Slot	Cruciform PH	Cruciform PZ	Internal TORX PLUS®	Internal TORX® with ball end	Internal hexagon with ball end	Internal hexagon

SOCKETS 12.5 MM (1/2")

19

SOCKET 1/2" hexagon

- ▲ Acc. to DIN 3124, ISO 2725-1
- ▲ Square drive as per DIN 3120 - C 12.5, ISO 1174, with ball retaining groove
- ▲ Hand-operated, knurled grip
- ▲ GEDORE vanadium steel 31CrV3, polished, chrome-plated
- ▲ * not standardised

12.5

1/2"

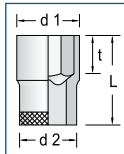

Code	No.	*	\varnothing mm	L	d ₁	d ₂	t	\pm	$\frac{t}{L}$
6130020	19 8		8	38.0	13.0	22.5	15.0	55	10
6130100	19 9	*	9	38.0	14.2	22.5	15.0	56	10
6130290	19 10		10	38.0	15.5	22.5	13.5	56	10
6130370	19 11		11	38.0	16.7	22.5	12.5	58	10
6130450	19 12		12	38.0	18.0	22.5	12.5	58	10
6130530	19 13		13	38.0	19.2	22.5	12.5	61	10
6130610	19 14		14	38.0	20.5	22.5	12.5	63	10

Code	No.	*	\varnothing mm	L	d ₁	d ₂	t	\pm	$\frac{t}{L}$
6130880	19 15		15	39.5	21.7	23.8	15.0	74	10
6130960	19 16		16	39.5	22.5	23.8	15.0	75	10
6131180	19 17		17	39.5	24.0	22.5	15.0	74	10
6131260	19 18		18	39.5	25.5	23.0	17.0	73	10
6131340	19 19		19	40.0	26.7	24.2	17.0	85	10
6131420	19 20		20	40.0	28.0	25.5	17.0	96	10
6131500	19 21		21	41.5	29.2	26.0	18.5	106	10
6131690	19 22		22	41.5	30.5	26.3	18.5	112	10
6131770	19 23	*	23	41.5	31.7	27.5	18.5	122	10
6131850	19 24		24	41.5	33.0	28.0	18.5	132	10
6131930	19 25	*	25	41.5	34.2	28.8	18.5	139	10
6132070	19 26	*	26	41.5	35.5	29.4	18.5	148	10
6132150	19 27		27	41.5	36.7	30.0	18.5	157	10
6132230	19 28	*	28	43.0	38.0	30.5	20.0	168	10
6132310	19 29	*	29	43.0	39.2	31.2	20.0	181	10
6132580	19 30		30	43.0	40.5	32.5	20.5	193	10
6132740	19 32		32	44.5	43.0	34.5	22.5	226	10
6138270	19 34		34	44.5	45.5	37.0	22.5	259	10
1718711	19 36	*	36	44.5	48.0	38.0	22.5	271	10

D 19

SOCKET 1/2" bi-hexagon UD profile

- ▲ Acc. to DIN 3124, ISO 2725-1
- ▲ Square drive as per DIN 3120 - C 12.5, ISO 1174, with ball retaining groove
- ▲ Hand-operated, knurled grip
- ▲ GEDORE vanadium steel 31CrV3, polished, chrome-plated
- ▲ * not standardised

12.5

1/2"

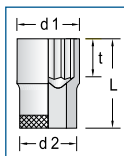

Code	No.	*	\varnothing mm	L	d ₁	d ₂	t	\pm	$\frac{t}{L}$
6133040	D 19 8		8	38.0	13.0	22.5	7.0	51	10
6133120	D 19 9	*	9	38.0	14.2	22.5	8.0	52	10
6133200	D 19 10		10	38.0	15.5	22.5	13.5	56	10
6133390	D 19 11		11	38.0	16.7	22.5	12.5	57	10
6133470	D 19 12		12	38.0	18.0	22.5	12.5	57	10
6133550	D 19 13		13	38.0	19.2	22.5	12.5	59	10
6133630	D 19 14		14	38.0	20.5	22.5	12.5	61	10
6133710	D 19 15		15	39.5	21.7	23.8	15.0	72	10
6133980	D 19 16		16	39.5	22.5	23.8	15.0	72	10
6134010	D 19 17		17	39.5	24.0	22.5	15.0	70	10
6134280	D 19 18		18	39.5	25.5	23.0	17.0	68	10
6134360	D 19 19		19	40.0	26.7	24.2	17.0	81	10
6134440	D 19 20		20	40.0	28.0	25.5	17.0	90	10
6134520	D 19 21		21	41.5	29.2	26.0	18.5	101	10
6134600	D 19 22		22	41.5	30.5	26.3	18.5	106	10
6134790	D 19 23	*	23	41.5	31.7	27.5	18.5	118	10
6134870	D 19 24		24	41.5	33.0	28.0	18.5	123	10
6134950	D 19 25	*	25	41.5	34.2	28.8	18.5	131	10
6135090	D 19 26	*	26	41.5	35.5	29.4	18.5	139	10
6135170	D 19 27		27	41.5	36.7	30.0	18.5	143	10
6135250	D 19 28	*	28	43.0	38.0	30.5	20.0	163	10
6135330	D 19 29	*	29	43.0	39.2	31.2	20.0	168	10
6135410	D 19 30		30	43.0	40.5	32.5	20.5	182	10
6135760	D 19 32		32	44.5	43.0	34.5	22.5	204	10
6135840	D 19 33	*	33	44.5	44.2	36.0	22.5	221	10
2194686	D 19 36	*	36	44.5	48.0	38.0	22.5	271	10

Code	No.	\varnothing AF	L	d ₁	d ₂	t	\pm	$\frac{t}{L}$
6136060	D 19 5/16AF	5/16	38.0	13.0	22.5	7.0	52	5
6136140	D 19 11/32AF	11/32	38.0	13.9	22.5	8.0	54	5
6136220	D 19 3/8AF	3/8	38.0	14.9	22.5	15.0	55	5
6136300	D 19 13/32AF	13/32	38.0	15.9	22.5	13.5	55	5
6136490	D 19 7/16AF	7/16	38.0	16.7	22.5	12.5	56	5
6136570	D 19 1/2AF	1/2	38.0	18.7	22.5	12.5	58	5
6136650	D 19 9/16AF	9/16	38.0	20.7	22.5	12.5	61	5
6136730	D 19 19/32AF	19/32	39.5	21.7	23.8	15.0	70	5
6136810	D 19 5/8AF	5/8	39.5	22.5	23.8	15.0	73	5
6137030	D 19 11/16AF	11/16	39.5	24.7	22.5	17.0	66	5
6137110	D 19 3/4AF	3/4	40.0	26.7	24.2	17.0	84	5
6137380	D 19 25/32AF	25/32	40.0	27.7	25.3	17.0	90	5
6137460	D 19 13/16AF	13/16	41.5	28.5	25.7	18.5	97	5
6137540	D 19 7/8AF	7/8	41.5	30.6	26.5	18.5	105	5
6137620	D 19 15/16AF	15/16	41.5	32.6	28.3	18.5	126	5
6137700	D 19 1AF	1	41.5	34.6	28.9	18.5	138	5
6137890	D 19 1.1/16AF	1.1/16	41.5	36.7	30.0	18.5	147	5
6137970	D 19 1.1/8AF	1.1/8	43.0	38.6	31.0	20.0	159	5
6138000	D 19 1.3/16AF	1.3/16	43.0	40.6	32.5	20.5	183	5
6138190	D 19 1.1/4AF	1.1/4	44.5	42.6	34.5	22.5	207	1

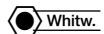

Code	No.	\varnothing mm	L	d ₁	d ₂	t	\pm	$\frac{t}{L}$
6138780	D 19 3/16W	3/16	38.0	17.0	22.5	12.5	54	1
6138860	D 19 1/4W	1/4	38.0	19.5	22.5	12.5	57	1
6138940	D 19 5/16W	5/16	39.5	21.9	23.8	15.0	69	1
6139080	D 19 3/8W	3/8	39.5	25.5	23.0	17.0	66	1
6139160	D 19 7/16W	7/16	41.5	28.8	26.0	18.5	96	1
6139240	D 19 1/2W	1/2	41.5	32.1	27.8	18.5	124	1
6139320	D 19 9/16W	9/16	41.5	34.9	29.2	18.5	137	1
6139400	D 19 5/8W	5/8	43.0	37.8	30.5	20.0	166	1
6139590	D 19 11/16W	11/16	43.0	41.0	33.0	20.5	184	1
6138430	D 19 3/4W	3/4	44.5	44.2	36.0	22.5	225	1



1/2"

19 L

SOCKET 1/2" hexagon, long pattern

- Acc. to DIN 3124, ISO 2725-1
- Square drive as per DIN 3120 - C 12.5, ISO 1174, with ball retaining groove
- Hand-operated, knurled grip
- GEDORE vanadium steel 31CrV3, polished, chrome-plated

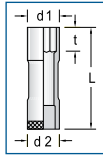

12.5
1/2"
SQUARE DRIVE

Code	No.	Ømm	L	d ₁	d ₂	t	±0.02	±0.01
1718738	19 L 10	10	77.0	15.5	22.5	12.0	117	1
1718746	19 L 11	11	77.0	16.7	22.5	13.0	121	1
1718754	19 L 12	12	77.0	18.0	22.5	14.0	127	1
1718762	19 L 13	13	77.0	19.2	22.5	16.0	98	1
1718770	19 L 14	14	77.0	20.5	22.5	17.0	109	1
1718789	19 L 15	15	77.0	21.7	22.5	17.0	117	1
1718800	19 L 16	16	77.0	23.0	24.0	18.0	130	1
1718819	19 L 17	17	77.0	24.0	24.0	18.0	132	1
1718827	19 L 18	18	82.0	25.5	25.0	20.0	147	1
1718835	19 L 19	19	82.0	26.7	26.0	22.0	174	1

Code	No.	Ømm	L	d ₁	d ₂	t	±0.02	±0.01
2300559	19 L 21	21	82.0	29.2	28.5	24.0	211	1
2300567	19 L 22	22	82.0	30.5	28.5	24.0	219	1
2300575	19 L 24	24	82.0	33.0	29.0	26.0	257	1
2300583	19 L 27	27	82.0	36.7	30.0	30.0	290	1
2300591	19 L 30	30	82.0	40.5	32.5	33.0	351	1
2300605	19 L 32	32	82.0	43.0	34.5	36.0	387	1
2300613	19 L 34	34	82.0	45.5	36.5	37.0	432	1



1/2"

D 19 L

SOCKET 1/2" bi-hexagon UD profile, long pattern

- Acc. to DIN 3124, ISO 2725-1
- Square drive as per DIN 3120 - C 12.5, ISO 1174, with ball retaining groove
- Hand-operated, knurled grip
- GEDORE vanadium steel 31CrV3, polished, chrome-plated
- Sizes 16, 18, 21 with hole drilled for tommy bar Ø 8 mm

12.5
1/2"
SQUARE DRIVE

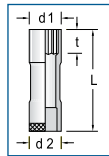

Code	No.	Ømm	L	d ₁	d ₂	t	±0.02	±0.01
6141140	D 19 L 10	10	77.0	15.5	22.5	12.0	117	10
6141220	D 19 L 12	12	77.0	18.0	22.5	14.0	127	10
6140170	D 19 L 13	13	77.0	19.2	22.5	16.0	101	10
6140250	D 19 L 14	14	77.0	20.5	22.5	17.0	109	10
6142460	D 19 L 15	15	77.0	21.7	22.5	17.0	119	10
6142540	D 19 L 16	16	77.0	23.0	24.0	18.0	128	10
6140330	D 19 L 17	17	77.0	24.0	24.0	18.0	133	10
6142380	D 19 L 18	18	82.0	25.5	25.0	20.0	147	10
6140410	D 19 L 19	19	82.0	26.7	26.0	22.0	175	10
6140680	D 19 L 21	21	82.0	29.2	28.5	24.0	211	10
6145050	D 19 L 22	22	82.0	30.5	28.5	24.0	219	10
6140760	D 19 L 24	24	82.0	33.0	29.0	26.0	257	10
6141060	D 19 L 27	27	82.0	36.7	30.0	30.0	290	10
6145640	D 19 L 30	30	82.0	40.5	32.5	33.0	351	10
6191320	D 19 L 32	32	82.0	43.0	34.5	36.0	387	10
6147500	D 19 L 34	34	82.0	45.5	36.5	37.0	432	5

AF

Code	No.	ØAF	L	d ₁	d ₂	t	±0.02	±0.01
6141300	D 19 L 1/2AF	1/2	77.0	18.7	22.5	16.0	95	1
6141490	D 19 L 9/16AF	9/16	77.0	20.7	22.5	17.0	105	1
6141570	D 19 L 5/8AF	5/8	77.0	22.5	24.0	18.0	120	1
6141650	D 19 L 11/16AF	11/16	77.0	24.7	24.8	18.0	143	1
6141730	D 19 L 3/4AF	3/4	82.0	26.7	26.0	22.0	164	1
6141810	D 19 L 13/16AF	13/16	82.0	28.5	28.5	22.0	197	1
6142030	D 19 L 7/8AF	7/8	82.0	30.6	28.5	24.0	208	1
6142110	D 19 L 15/16AF	15/16	82.0	32.6	29.0	26.0	234	1

TX 19

SOCKET 1/2" for protruding TORX® head screws

- Square drive as per DIN 3120 - C 12.5, ISO 1174, with ball retaining groove
- Hand-operated, knurled grip
- GEDORE vanadium steel 31CrV3, polished, chrome-plated
- TORX® = reg. trademark of Acument Intellectual Properties, LLC. USA

12.5
1/2"
SQUARE DRIVE

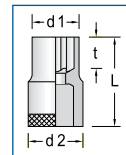

Code	No.	Ø	±0.02	±0.01	mm	L	d ₁	d ₂	t	±0.02	±0.01
6145720	TX 19 E10	E10	M8	9.42	38.0	13.5	22.5	15.5	56	10	10
6194180	TX 19 E11	E11	-	10.08	38.0	14.0	22.5	15.5	55	5	5
6147340	TX 19 E12	E12	M10	11.17	38.0	15.5	22.5	15.5	59	10	10
6147420	TX 19 E14	E14	M12	12.90	38.0	17.0	22.5	13.0	59	10	10
6194420	TX 19 E16	E16	M12	14.76	38.0	19.0	22.5	13.0	62	10	10
6194500	TX 19 E18	E18	M14	16.70	40.0	21.0	24.5	14.0	78	10	10
6194690	TX 19 E20	E20	M16	18.45	40.0	23.5	24.5	14.0	85	10	10
6195070	TX 19 E24	E24	M18 - M20	22.16	41.5	28.5	26.0	16.0	116	5	5

ITX 19

SCREWDRIVER BIT SOCKET 1/2" for recessed TORX® head screws

- Square drive as per DIN 3120 - C 12.5, ISO 1174, with ball retaining groove
- Hand-operated, knurled grip
- Chrome-plated
- With pressed-in pin in GEDORE vanadium special steel, gun-metal finish
- TORX® = reg. trademark of Acument Intellectual Properties, LLC. USA

12.5
1/2"
SQUARE DRIVE

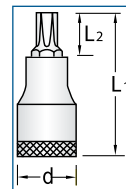

Code	No.	Ø	±0.02	±0.01	mm	L ₁	L ₂	d	±0.02	±0.01
6152930	ITX 19 T20	T20	M4 - M5	3.86	55	17	22.5	76	10	10
6154200	ITX 19 T25	T25	M4,5 - M5	4.43	55	17	22.5	75	10	10
6154630	ITX 19 T27	T27	M4,5 - M6	4.99	55	17	22.5	76	10	10
6156170	ITX 19 T30	T30	M6 - M7	5.52	55	17	22.5	75	10	10
6156330	ITX 19 T40	T40	M7 - M8	6.65	55	17	22.5	76	10	10
6157060	ITX 19 T45	T45	M8 - M10	7.82	55	17	22.5	77	10	10
6158030	ITX 19 T50	T50	M10	8.83	55	17	22.5	92	10	10
6158380	ITX 19 T55	T55	M12	11.22	55	17	23.0	107	10	10
6158540	ITX 19 T60	T60	M14	13.25	55	15	24.7	137	10	10

ITX 19 L

SCREWDRIVER BIT SOCKET 1/2" for recessed TORX® head screws, long pattern

- Square drive as per DIN 3120 - C 12.5, ISO 1174, with ball retaining groove
- Hand-operated, knurled grip
- Chrome-plated
- With pressed-in pin in GEDORE vanadium special steel, gun-metal finish
- TORX® = reg. trademark of Acument Intellectual Properties, LLC. USA

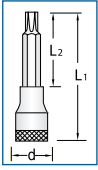

Code	No.	⊕	mm	mm	L ₁	L ₂	d	mm	mm
6188020	ITX 19 LT20-100	T20	M4 - M5	3.86	100	62	22.5	95	5
6188100	ITX 19 LT25-100	T25	M4,5 - M5	4.43	100	62	22.5	95	5
6188370	ITX 19 LT27-100	T27	M4,5 - M6	4.99	100	62	22.5	96	5
6152500	ITX 19 LT30-100	T30	M6 - M7	5.52	100	62	22.5	96	10
6152690	ITX 19 LT40-100	T40	M7 - M8	6.65	100	62	22.5	96	10
6155870	ITX 19 LT45-100	T45	M8 - M10	7.82	100	62	22.5	98	10
6158700	ITX 19 LT50-100	T50	M10	8.83	100	62	22.5	124	10
6159940	ITX 19 LT55-100	T55	M12	11.22	100	62	23.0	151	10
6188450	ITX 19 LT60-100	T60	M14	13.25	100	60	24.7	197	5
6105180	ITX 19 LT70-100	T70	M16	15.55	100	60	28.0	277	5

ITX 19 B

SCREWDRIVER BIT SOCKET 1/2" for recessed TORX® head screws with pilot

- Square drive as per DIN 3120 - C 12.5, ISO 1174, with ball retaining groove
- Hand-operated, knurled grip
- Chrome-plated
- With pressed-in pin in GEDORE vanadium special steel, gun-metal finish
- TORX® = reg. trademark of Acument Intellectual Properties, LLC. USA



Code	No.	⊕	mm	mm	mm	L ₁	L ₂	d	Bore	mm	mm
6192720	ITX 19 B T20	T20	M4 - M5	3.86	55	17	22.5	1,55 x 1,86	75	5	
6195660	ITX 19 B T25	T25	M4,5 - M5	4.43	55	17	22.5	1,93 x 2,04	75	5	
6196390	ITX 19 B T27	T27	M4,5 - M6	4.99	55	17	22.5	2,18 x 2,29	76	5	
6200170	ITX 19 B T30	T30	M6 - M7	5.52	55	17	22.5	2,56 x 2,92	76	5	
6200410	ITX 19 B T40	T40	M7 - M8	6.65	55	17	22.5	2,92 x 3,28	91	5	
6200840	ITX 19 B T45	T45	M8 - M10	7.82	55	17	22.5	3,45 x 3,68	92	5	
6201300	ITX 19 B T50	T50	M10	8.83	55	17	23.0	3,83 x 3,78	105	5	
6202700	ITX 19 B T55	T55	M12	11.22	55	15	24.7	4,85 x 4,79	133	5	
6203270	ITX 19 B T60	T60	M14	13.25	56	16	28.0	5,63 x 7,87	182	5	

IS 19

SCREWDRIVER BIT SOCKET 1/2" for slotted head screws

- Square drive as per DIN 3120 - C 12.5, ISO 1174, with ball retaining groove
- Hand-operated, knurled grip
- Chrome-plated
- With pressed-in pin in GEDORE vanadium special steel, manganese-phosphated
- Blade as per DIN ISO 2380-1, Form B

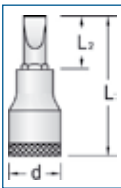

Code	No.	mm	mm	L ₁	L ₂	d	mm	mm
6161760	IS 19 6,5x1,2	1.2	6.5	60	22	22.5	71	1
6656060	IS 19 8x1,2	1.2	8.0	60	22	22.5	80	5
6656140	IS 19 10x1,6	1.6	10.0	60	22	22.5	115	5
6656220	IS 19 12x2	2.0	12.0	60	22	23.0	110	5
6162140	IS 19 14x2,5	2.5	14.0	60	20	24.7	138	5
6656490	IS 19 16x2,5	2.5	16.0	60	20	28.0	190	5
6656570	IS 19 18x2,5	2.5	18.0	60	20	27.0	193	10

IKS 19

SCREWDRIVER BIT SOCKET 1/2" for cross-slotted head screws PH

- Square drive as per DIN 3120 - C 12.5, ISO 1174, with ball retaining groove
- Hand-operated, knurled grip
- Chrome-plated
- With pressed-in pin in GEDORE vanadium special steel, gun-metal finish
- Tip as per DIN ISO 8764-1 PH

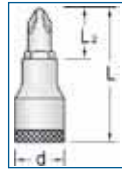
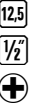

Code	No.	⊕ PH	L ₁	L ₂	d	mm	mm
6656650	IKS 19 2	2	60	22	22.5	77	10
6656730	IKS 19 3	3	60	22	22.5	92	10
6656810	IKS 19 4	4	60	22	23.0	106	10

IKS 19 PZD

SCREWDRIVER BIT SOCKET 1/2" for cross-slotted head screws PZ

- Square drive as per DIN 3120 - C 12.5, ISO 1174, with ball retaining groove
- Hand-operated, knurled grip
- Chrome-plated
- With pressed-in pin in GEDORE vanadium special steel, gun-metal finish
- Tip as per DIN ISO 8764-1 PZ

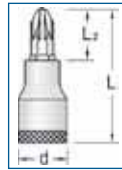

Code	No.	⊕ PZ	L ₁	L ₂	d	mm	mm
6156680	IKS 19 PZD 2	2	60	22	22.5	77	10
6156760	IKS 19 PZD 3	3	60	22	22.5	91	10
6156840	IKS 19 PZD 4	4	60	22	23.0	108	5

IN 19

SCREWDRIVER BIT SOCKET 1/2" for in-hex screws

- Acc. to DIN 7422
- Square drive as per DIN 3120 - C 12.5, ISO 1174, with ball retaining groove
- Hand-operated, knurled grip
- Chrome-plated
- With pressed-in pin in GEDORE vanadium special steel, manganese-phosphated
- **IN 19 17** for oil filter and drain plug screws
- * not standardised

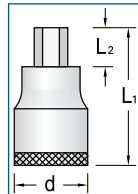
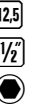

mm

Code	No.	*	mm	L ₁	L ₂	d	mm	mm
6153070	IN 19 4	*	4	60	22	22.5	68	10
6153150	IN 19 5	*	5	60	22	22.5	69	10
6153230	IN 19 6	*	6	60	22	22.5	70	10
6153310	IN 19 7	*	7	60	22	22.5	75	10
6153580	IN 19 8	*	8	60	22	22.5	82	10
6153660	IN 19 9	*	9	60	22	22.5	91	10
6153740	IN 19 10	*	10	60	22	22.5	99	10
6153820	IN 19 12	*	12	60	22	23.0	113	10
6153900	IN 19 14	*	14	60	20	24.7	149	10
6154040	IN 19 17	*	17	60	20	28.0	210	10
6154120	IN 19 19	*	19	60	20	27.0	222	10

IN 19

AF

Code	No.	●"AF	L ₁	L ₂	d	↺↻	☑
6154710	IN 19 3/16AF	3/16	60	22	22.5	69	10
6154980	IN 19 7/32AF	7/32	60	22	22.5	69	10
6155010	IN 19 1/4AF	1/4	60	22	22.5	73	10
6155280	IN 19 9/32AF	9/32	60	22	22.5	76	5
6155360	IN 19 5/16AF	5/16	60	22	22.5	81	10
6155440	IN 19 3/8AF	3/8	60	22	22.5	98	10
6155520	IN 19 1/2AF	1/2	60	22	23.0	119	10
6155600	IN 19 9/16AF	9/16	60	20	24.7	150	10
6155790	IN 19 5/8AF	5/8	60	20	28.0	205	10

IN 19 L

SCREWDRIVER BIT SOCKET 1/2" for in-hex screws, long pattern

- Acc. to DIN 7422
- Square drive as per DIN 3120 - C 12.5, ISO 1174, with ball retaining groove
- Hand-operated, knurled grip
- Chrome-plated
- With pressed-in pin in GEDORE vanadium special steel, manganese-phosphated
- * t = stepped hexagon bit 13 mm
- * not standardised

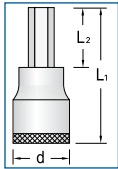

Code	No.	*	●mm	L ₁	L ₂	d	* t	↺↻	☑
6162060	IN 19 L 5-90	*	5	90	52	22.5	13	91	10
6157140	IN 19 L 5-180	*	5	180	142	22.5	13	131	10
6157300	IN 19 L 6-90		6	90	52	22.5		79	10
6145800	IN 19 L 6-140		6	140	102	22.5	13	115	10
6145990	IN 19 L 6-160		6	160	122	22.5	13	123	10
6157570	IN 19 L 7-100		7	100	62	22.5		89	10
6157730	IN 19 L 8-90		8	90	52	22.5		95	10
6157810	IN 19 L 8-120		8	120	82	22.5		109	10
6158110	IN 19 L 10-140		10	140	102	22.5		154	10
6158460	IN 19 L 12-140		12	140	102	23.0		195	10
6158620	IN 19 L 14-140		14	140	100	24.7		257	10

IN 19 K

SCREWDRIVER BIT SOCKET 1/2" with ball end, for in-hex screws

- Square drive as per DIN 3120 - C 12.5, ISO 1174, with ball retaining groove
- Hand-operated, knurled grip
- Chrome-plated
- With pressed-in pin in GEDORE vanadium special steel, gun-metal finish
- Total swivel angle approx. 15-20°

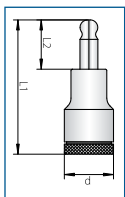

Code	No.	●mm	L ₁	L ₂	d	↺↻	☑
2219336	IN 19 K 6	6	60	22	22.5	68	1
2219360	IN 19 K 7	7	60	22	22.5	71	1
2219379	IN 19 K 8	8	60	22	22.5	80	1
2219395	IN 19 K 10	10	60	22	22.5	100	1

IN 19 LK

SCREWDRIVER BIT SOCKET 1/2" with ball end, for in-hex screws, long pattern

- Square drive as per DIN 3120 - C 12.5, ISO 1174, with ball retaining groove
- Hand-operated, knurled grip
- Chrome-plated
- With pressed-in pin in GEDORE vanadium special steel, gun-metal finish
- Total swivel angle approx. 15°-20°

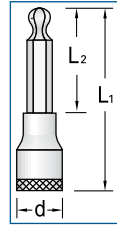

Code	No.	●mm	L ₁	L ₂	d	↺↻	☑
6162810	IN 19 LK 6-140	6	140	102	22.5	91	10
6165080	IN 19 LK 7-140	7	140	102	22.5	103	5
6165160	IN 19 LK 8-140	8	140	102	22.5	116	10
6166800	IN 19 LK 10-140	10	140	102	22.5	153	10
6172370	IN 19 LK 12-140	12	140	102	23.0	195	5

INR 19 L

SCREWDRIVER BIT SOCKET 1/2" for multi-spline screws RIBE®, long pattern

- RIBE® = reg. trademark of Richard Bergner GmbH & Co. KG, Schwabach, Germany

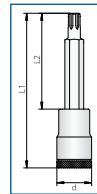

Code	No.	□mm	L ₁	L ₂	d	↺↻	☑
1449826	INR 19 L 5-100	M5	100	62	22.5	85	1
1449850	INR 19 L 6-100	M6	100	62	22.5	85	1
1450859	INR 19 L 6-188	M6	188	150	22.5	120	1
1449877	INR 19 L 8-100	M8	100	62	22.5	85	1
1450875	INR 19 L 8-188	M8	188	150	22.5	125	1
1449591	INR 19 L 10-100	M10	100	62	22.5	105	1
1450891	INR 19 L 10-188	M10	188	150	22.5	165	1
1398636	INR 19 L 12-100	M12	100	62	22.5	145	1
1450913	INR 19 L 12-188	M12	188	150	22.5	230	1
1449893	INR 19 L 14-100	M14	100	60	24.7	155	1

INX 19

SCREWDRIVER BIT SOCKET 1/2" for multi-point screws XZN

- Acc. to DIN 2324
- Square drive as per DIN 3120 - C 12.5, ISO 1174, with ball retaining groove
- Hand-operated, knurled grip
- Chrome-plated
- With pressed-in pin in GEDORE vanadium special steel, manganese-phosphated
- Tip as per DIN 2325
- * not standardised

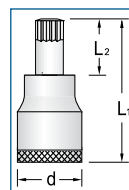

Code	No.	*	□mm	L ₁	L ₂	d	↺↻	☑
6158890	INX 19 5	*	M5	55	17	22.5	75	10
6159000	INX 19 6	*	M6	55	17	22.5	76	10
6159270	INX 19 8		M8	55	17	22.5	77	10
6159430	INX 19 10		M10	55	17	22.5	94	10
6159780	INX 19 12		M12	55	17	23.0	110	10
1888943	INX 19 14		M14	57	17	24.7	85	10

INX 19 L

SCREWDRIVER BIT SOCKET 1/2" for multi-point screws XZN, long pattern

- ✔ Acc. to DIN 2324
- ✔ Square drive as per DIN 3120 - C 12.5, ISO 1174, with ball retaining groove
- ✔ Hand-operated, knurled grip
- ✔ Chrome-plated
- ✔ With pressed-in pin in GEDORE vanadium special steel, manganese-phosphated
- ✔ Tip as per DIN 2325
- ✔ * not standardised

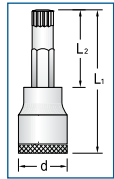

Code	No.	* □	□	■	■	↳mm↳	↕	☰
6159190	INX 19 L 6-100	*	M6	100	62	22.5	93	10
6159350	INX 19 L 8-100		M8	100	62	22.5	97	10
6159510	INX 19 L 10-100		M10	100	62	22.5	124	10
6159860	INX 19 L 12-100		M12	100	62	23.0	149	10
1888951	INX 19 L 14-100		M14	100	60	24.7	110	10

ACCESSORIES 12.5 MM (1/2")

1930

REDUCER 1/2" TO 3/8"

- ✔ Acc. to DIN 3123, ISO 3316
- ✔ For hand-operated sockets with square drive as per DIN 3120, ISO 1174, with ball locking device
- ✔ GEDORE vanadium steel 31CrV3, polished, chrome-plated



Code	No.	□*	□	■*	■	↳mm↳	↕	☰
6143000	1930	1/2	12.5	3/8	10	38.5	62	10

1932

CONVERTOR 1/2" TO 3/4"

- ✔ Acc. to DIN 3123, ISO 3316
- ✔ For hand-operated sockets with square drive as per DIN 3120, ISO 1174, with ball locking device
- ✔ GEDORE vanadium steel 31CrV3, polished, chrome-plated



Code	No.	□*	□	■*	■	↳mm↳	↕	☰
6143190	1932	1/2	12.5	3/4	20	44	128	10

1940

HIGH-SPEED SWIVEL DISC for 1/2" ratchets

- ✔ For 12.5 mm (1/2") ratchets
- ✔ Tightens loose screws with a flick of the wrist
- ✔ Easy assembly between release head and socket
- ✔ Speeds up the screwing process

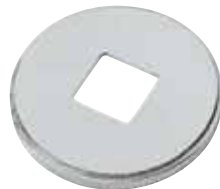

Code	No.	□*	□	↳mm↳	☰
1640887	1940	1/2	12.5	14	1

1981 K

L-HANDLE 1/2"

- ✔ Acc. to DIN 3122, ISO 3315
- ✔ For hand-operated sockets with square drive as per DIN 3120, ISO 1174, with ball locking device
- ✔ GEDORE vanadium steel 31CrV3, polished, chrome-plated



Code	No.	□*	■	↳mm↳	↕	☰
6143270	1981 K	1/2	12.5	220	267	1

1985

SPEED BRACE 1/2"

- ✔ Acc. to DIN 3122, ISO 3315
- ✔ For hand-operated sockets with square drive as per DIN 3120, ISO 1174, with ball locking device
- ✔ GEDORE vanadium steel 31CrV3, polished, chrome-plated



Code	No.	□*	■	↳mm↳	↕	☰
6143350	1985	1/2	12.5	395	619	1

1987

SLIDING T BAR 1/2"

- ✔ Acc. to DIN 3122, ISO 3315
- ✔ For hand-operated sockets with square drive as per DIN 3120, ISO 1174, with ball locking device
- ✔ GEDORE vanadium steel 31CrV3, polished, chrome-plated



Code	No.	□*	■	↳mm↳	↕	☰
6143430	1987	1/2	12.5	292	386	10

1987 A

SLIDING T BAR WITH RELEASE 1/2"

- ✔ Secured against unintentional removal
- ✔ GEDORE vanadium steel 31CrV3, polished, chrome-plated
- ✔ Turn handle for easy locking and releasing
- ✔ Accidental release when working is prevented because of the asymmetrical release point
- ✔ Ideal for situations where sockets must not become detached
- ✔ Examples: Aircraft engine, work in deep machine bodies
- ✔ DBGM



Code	No.	□*	■	↳mm↳	↕	☰
1871641	1987 A	1/2	12.5	292	375	1

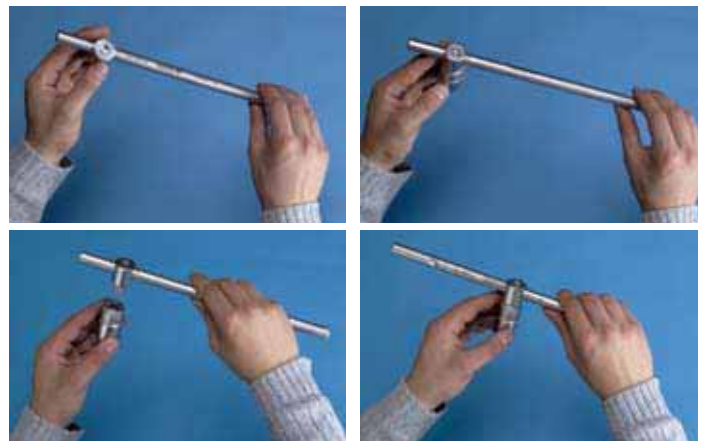

1990

EXTENSION 1/2"

- Acc. to DIN 3123, ISO 3316
- For hand-operated sockets with square drive as per DIN 3120, ISO 1174, with ball locking device
- GEDORE vanadium steel 31CrV3, chrome-plated

12,5
1/2"

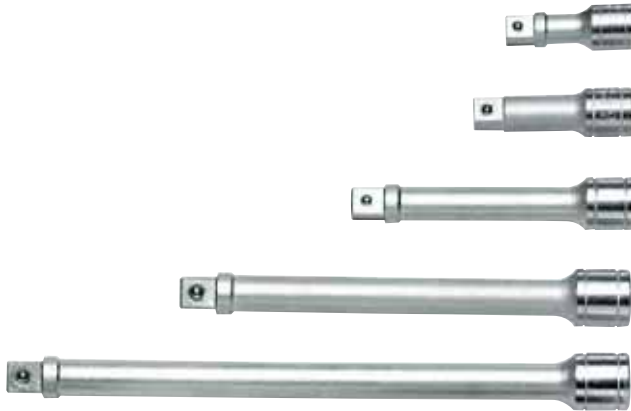

Code	No.	*	■	■	(mm)	↕	📦
6143510	1990-2.1/2	*	1/2	12.5	63	115	10
6143780	1990-3		1/2	12.5	76	137	10
6143860	1990-5		1/2	12.5	125	188	10
6142890	1990-7	*	1/2	12.5	180	264	10
6143940	1990-10		1/2	12.5	250	361	10
6129950	1990-12	*	1/2	12.5	305	411	1

1990 A

EXTENSION 1/2" with release

- Easy access to deep-fitting screws
- Locking ring prevents unintentional release of the socket
- For hand-operated sockets with square drive as per DIN 3120, ISO 1174, with ball locking device

12,5
1/2"



Code	No.	■	■	(mm)	↕	📦
1640828	1990 A-5	1/2	12.5	125	216	1
1640801	1990 A-10	1/2	12.5	250	386	1



Deviant packing units see article description.

1990 KR

UNIVERSAL EXTENSION 1/2"

- With ball end
- For hand-operated sockets with square drive as per DIN 3120, ISO 1174, with ball locking device
- The extension is able to pivot up to 15°
- Load capacity max. 230 N·m
- GEDORE vanadium steel 31CrV3, polished, chrome-plated

12,5
1/2"



Code	No.	■	■	(mm)	↕	📦
6173180	1990 KR-5	1/2	12.5	125	180	1
6225590	1990 KR-7	1/2	12.5	180	255	1
6366570	1990 KR-10	1/2	12.5	250	345	1



1994

COUPLER 1/2"

- Acc. to DIN 3122, ISO 3315
- For hand-operated sockets with square drive as per DIN 3120, ISO 1174, with ball locking device
- GEDORE vanadium steel 31CrV3, chrome-plated, polished

12,5
1/2"



Code	No.	■	■	(mm)	↕	📦
6144670	1994	1/2	12.5	37.8	45	10

1995

UNIVERSAL JOINT 1/2"

- Acc. to DIN 3123, ISO 3316
- For hand-operated sockets with square drive as per DIN 3120, ISO 1174, with ball locking device
- GEDORE vanadium steel 31CrV3, chrome-plated, polished

12,5
1/2"



Code	No.	■	■	□	□	(mm)	↕	📦
6144750	1995	1/2	12.5	1/2	12.5	72	159	10

1996 - 1997

SWIVEL HANDLE 1/2"

- Acc. to DIN 3122, ISO 3315
- For hand-operated sockets with square drive as per DIN 3120, ISO 1174, with ball locking device
- GEDORE vanadium steel 31CrV3, chrome-plated, polished

12,5
1/2"



Code	No.	■	■	(mm)	↕	📦
6144830	1996	1/2	12.5	255	426	1
6144910	1997	1/2	12.5	381	593	10

1998

SWIVEL HANDLE WITH SLIDING T 1/2"

- For hand-operated sockets with square drive as per DIN 3120, ISO 1174, with ball locking device
- GEDORE vanadium steel 31CrV3, chrome-plated, polished

12.5
1/2"



Code	No.	mm	mm	mm	mm	mm
6199730	1998	1/2	12.5	460	747	1

VH 19

SPRING STEEL SOCKET RAIL 1/2"

- For 14 1/2" sockets
- Delivery without tools

12.5
1/2"



Code	No.	mm	mm
5162520	VH 19	65	1

SL 19

TOOL HOLDING RAIL, MAGNETIC 1/2" empty

- External squares to take 12 or 16 standard commercial 12.5 mm (1/2") sockets
- Two female square adaptors to take ratchets, sliding T bars, extensions etc.
- A strong magnet securely holds the socket rail to ferrous metals
- Additional holes are provided for wall mounting the socket rail or attaching to non-ferrous materials
- The sockets are securely locked by the ball at the square-drive end by turning them 90°
- It is a simple matter to "unlock" and remove the sockets, by turning them 90° in the opposing direction
- Delivery without tools

12.5
1/2"
12.5
1/2"

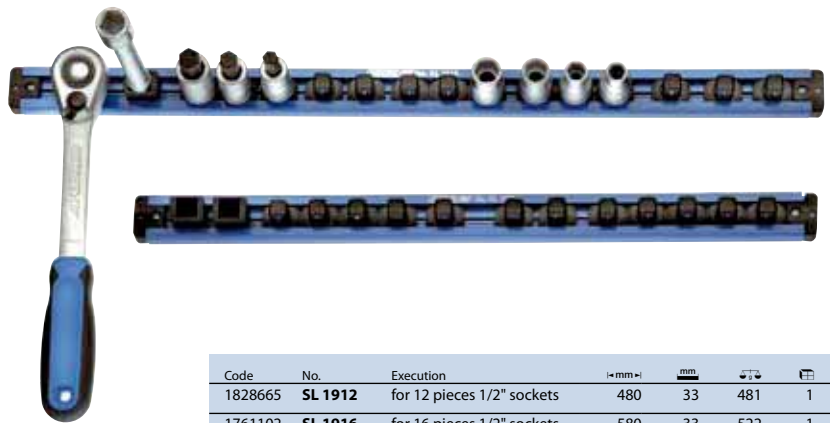

Code	No.	Execution	mm	mm	mm	mm
1828665	SL 1912	for 12 pieces 1/2" sockets	480	33	481	1
1761102	SL 1916	for 16 pieces 1/2" sockets	580	33	522	1



S 2032-05



157



19 V20U-10



194



SETS 12.5 MM (1/2") METRIC

12.5 1/2"

19 KMU / D 19 KMU

SOCKET SET 1/2" 11 pieces

- With forged, tempered hexagon (no.19) or UD profile sockets (no. D 19), hand-operated
- With accessories made from GEDORE vanadium steel 31CrV
- With fine toothed, dial change ratchet
- In GEDORIT blue sheet steel case
- Dimensions: 281 x 79 x 48 mm



12.5
1/2"
UNIT DRIVE
UNIT DRIVE



1/2"

mm

Code	No.	Ratchet	Sockets	Accessories	Weight	Units
1953850	19 KMU-3	U-3 1993 U-3	19 10 11 13 14 15 17 19 22 24	1990-5	1.9	1
1953958	D 19 KMU-3	U-3 1993 U-3	D 19 10 11 13 14 15 17 19 22 24	1990-5	1.8	1

19 HMU / D 19 HMU

SOCKET SET 1/2" 13 pieces

- With forged, tempered hexagon (no.19) or UD profile sockets (no. D 19), hand-operated
- With accessories made from GEDORE vanadium steel 31CrV
- With fine toothed, dial change ratchet
- In GEDORIT blue sheet steel case
- Dimensions: 281 x 79 x 48 mm



12.5
1/2"
UNIT DRIVE
UNIT DRIVE

mm

Code	No.	Ratchet	Sockets	Accessories	Weight	Units
1953842	19 HMU-3	U-3 1993 U-3	19 8 9 10 11 12 13 14 15 17 19 22	1990-5	1.9	1
1953931	D 19 HMU-3	U-3 1993 U-3	D 19 8 9 10 11 12 13 14 15 17 19 22	1990-5	1.9	1

19 GMU

SOCKET SET 1/2" 16 pieces

- With forged, tempered hexagon sockets, hand-operated
- With accessories made from GEDORE vanadium steel 31CrV
- With reversible with lever change ratchet
- In GEDORIT blue sheet steel case
- Dimensions: 320 x 210 x 55 mm



12.5
1/2"
UNIT DRIVE

mm

Code	No.	Ratchet	Sockets	Accessories	Weight	Units
6122190	19 GMU-10	U-10T 1993 U-10 T	19 10 11 12 13 14 16 17 18 19 21 22 24	1990-5 -10 1987	3.6	1

i The GEDORE socket set

- ✔ Innovative, functional design
- ✔ Sheet steel case - inside-folded, seamless edge provides added strength. The tool and foam inserts are secured to prevent them being lost
- ✔ ABS plastic tool insert, resistant to oils and greases
- ✔ Tool insert with the socket sizes permanently laser marked
- ✔ With the lid closed, the tools sit securely in their pockets
- ✔ Boxes designed so that they can be stacked easily
- ✔ Large, rounded fasteners can be opened and closed even when the user is wearing gloves
- ✔ Contoured carry handle ensures comfortable carrying even for long periods
- ✔ Environmentally-friendly powder-coated in GEDORIT blue



19 PQMU / D 19 PQMU

- SOCKET SET 1/2" 16 pieces**
- ✔ With forged, tempered hexagon (no.19) or UD profile sockets (no. D 19), hand-operated
 - ✔ With accessories made from GEDORE vanadium steel 31CrV3
 - ✔ With reversible with lever change ratchet
 - ✔ In GEDORIT blue sheet steel case
 - ✔ Dimensions: 320 x 210 x 55 mm



Code	No.	Ratchet	Sockets	Accessories	mm	📦
6182920	19 PQMU-10	☉ U-10T 1993 U-10 T	☉ 19 8 10 11 12 13 14 15 17 19 22 24 ☐ 50 MH (20,8)	☞ 1990-7 ☞ 1987 ☞ 1995	3.4	1
6185270	D 19 PQMU-10	☉ U-10T 1993 U-10 T	☉ D 19 8 10 11 12 13 14 15 17 19 22 24 ☐ 50 MH (20,8)	☞ 1990-7 ☞ 1987 ☞ 1995	3.4	1

➔ 1500 ES-D19



86



➔ 1500 ES-1993 T



88



19 QMU / D 19 QMU

SOCKET SET 1/2" 17 pieces

- With forged, tempered hexagon (no.19) or UD profile sockets (no. D 19), hand-operated
- With accessories made from GEDORE vanadium steel 31CrV3
- Set U-10 T with reversible with lever change ratchet
- Set U-3 with fine toothed, dial change ratchet
- In GEDORIT blue sheet steel case
- Dimensions: 320 x 210 x 55 mm

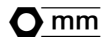

Code	No.	Ratchet	Sockets	Accessories	mm	mm
1953869	19 QMU-3	U-3 1993 U-3	19 10 11 12 13 14 15 17 19 22 24 27 30 32	1987 1990-10 1995	4.0	1
6151450	19 QMU-10	U-10T 1993 U-10 T	19 10 11 12 13 14 15 17 19 22 24 27 30 32	1987 1990-10 1995	4.1	1
1953966	D 19 QMU-3	U-3 1993 U-3	D 19 10 11 12 13 14 15 17 19 22 24 27 30 32	1987 1990-10 1995	3.9	1
6151530	D 19 QMU-10	U-10T 1993 U-10 T	D 19 10 11 12 13 14 15 17 19 22 24 27 30 32	1987 1990-10 1995	4.0	1

19 FMU / D 19 FMU

SOCKET SET 1/2" 19 pieces

- With forged, tempered hexagon (no.19) or UD profile sockets (no. D 19), hand-operated
- With accessories made from GEDORE vanadium steel 31CrV3
- Set U-10 T with reversible with lever change ratchet
- Set U-3 with fine toothed, dial change ratchet
- In GEDORIT blue sheet steel case
- Dimensions: 320 x 210 x 55 mm



Code	No.	Ratchet	Sockets	Accessories	mm	mm
1953834	19 FMU-3	U-3 1993 U-3	19 10 11 12 13 14 15 16 17 19 22 24 27 30 32	1987 1990-5 -10 1995	4.8	1
6150990	19 FMU-10	U-10T 1993 U-10 T	19 10 11 12 13 14 15 16 17 19 22 24 27 30 32	1987 1990-5 -10 1995	4.8	1
1953877	D 19 FMU-3	U-3 1993 U-3	D 19 10 11 12 13 14 15 16 17 19 22 24 27 30 32	1987 1990-5 -10 1995	4.7	1
6151290	D 19 FMU-10	U-10T 1993 U-10 T	D 19 10 11 12 13 14 15 16 17 19 22 24 27 30 32	1987 1990-5 -10 1995	4.7	1













19 EMU / D 19 EMU

SOCKET SET 1/2" 21 pieces

- With forged, tempered hexagon (no.19) or UD profile sockets (no. D 19), hand-operated
- With accessories made from GEDORE vanadium steel 31CrV3
- With reversible with lever change ratchet
- In GEDORIT blue sheet steel case
- Dimensions: 433 x 180 x 48 mm



 mm

Code	No.	Ratchet	Sockets	Accessories		
6630850	19 EMU-10	 U-10T 1993 U-10T	 19 8 9 10 11 12 13 14 15 16 17 19 22 24 27 30 32	 1987  1990-5 -10  1995	4.6	1
1413643	D 19 EMU-10	 U-10T 1993 U-10T	 D 19 8 9 10 11 12 13 14 15 16 17 19 22 24 27 30 32	 1987  1990-5 -10  1995	4.6	1























19 WMU / D 19 WMU

SOCKET SET 1/2" 24 pieces

- With forged, tempered hexagon (no.19) or UD profile sockets (no. D 19), hand-operated
- With accessories made from GEDORE vanadium steel 31CrV3
- Set U-10 T with reversible with lever change ratchet
- Set U-3 with fine toothed, dial change ratchet
- In GEDORIT blue sheet steel case
- Dimensions: 433 x 180 x 48 mm



 mm

Code	No.	Ratchet	Sockets	Accessories		
1953990	19 WMU-3	 U-3 1993 U-3	 19 10 11 12 13 14 15 16 17 18 19 21 22 23 24 26 27 28 30 32	 1987  1990-5 -10  1995	3.8	1
1954032	D 19 WMU-3	 U-3 1993 U-3	 D 19 10 11 12 13 14 15 16 17 18 19 21 22 23 24 26 27 28 30 32	 1987  1990-5 -10  1995	4.2	1
6154390	19 WMU-10	 U-10T 1993 U-10T	 19 10 11 12 13 14 15 16 17 18 19 21 22 23 24 26 27 28 30 32	 1987  1990-5 -10  1995	5.3	1
6154470	D 19 WMU-10	 U-10T 1993 U-10T	 D 19 10 11 12 13 14 15 16 17 18 19 21 22 23 24 26 27 28 30 32	 1987  1990-5 -10  1995	5.2	1

19 TM / D 19 TM

SOCKET SET 1/2" 25 pieces

- With forged, tempered hexagon (no.19) or UD profile sockets (no. D 19), hand-operated
- With accessories made from GEDORE vanadium steel 31CrV3
- Set U-10 T with reversible with lever change ratchet
- Set U-3 with fine toothed, dial change ratchet
- Set Z-94 with ratchet with square coupler
- In GEDORIT blue sheet steel case
- Dimensions: 525 x 203 x 50 mm



mm

Code	No.	Ratchet	Sockets	Accessories	mm	1
6148230	19 TMZ	☉ Z-94 1993 Z-94	☉ 19 10 11 12 13 14 15 16 17 18 19 21 22 23 24 26 27 28 30 32	☐ 1985 ☐ 1987 ☐ 1990-5 -10 ☐ 1995	6.7	1
1953982	19 TMU-3	☉ U-3 1993 U-3	☉ 19 10 11 12 13 14 15 16 17 18 19 21 22 23 24 26 27 28 30 32	☐ 1985 ☐ 1987 ☐ 1990-5 -10 ☐ 1995	6.7	1
6151880	19 TMU-10	☉ U-10T 1993 U-10 T	☉ 19 10 11 12 13 14 15 16 17 18 19 21 22 23 24 26 27 28 30 32	☐ 1985 ☐ 1987 ☐ 1990-5 -10 ☐ 1995	6.8	1
6148310	D 19 TMZ	☉ Z-94 1993 Z-94	☉ D 19 10 11 12 13 14 15 16 17 18 19 21 22 23 24 26 27 28 30 32	☐ 1985 ☐ 1987 ☐ 1990-5 -10 ☐ 1995	6.5	1
1954016	D 19 TMU-3	☉ U-3 1993 U-3	☉ D 19 10 11 12 13 14 15 16 17 18 19 21 22 23 24 26 27 28 30 32	☐ 1985 ☐ 1987 ☐ 1990-5 -10 ☐ 1995	6.5	1
6151960	D 19 TMU-10	☉ U-10T 1993 U-10 T	☉ D 19 10 11 12 13 14 15 16 17 18 19 21 22 23 24 26 27 28 30 32	☐ 1985 ☐ 1987 ☐ 1990-5 -10 ☐ 1995	6.6	1

19 IMU / D 19 IMU

SOCKET SET 1/2" 27 pieces

- With forged, tempered hexagon (no.19) or UD profile sockets (no. D 19), hand-operated
- With accessories made from GEDORE vanadium steel 31CrV3
- Set U-10 T with reversible with lever change ratchet
- Set U-3 with fine toothed, dial change ratchet
- In GEDORIT blue sheet steel case
- Dimensions: 433 x 180 x 48 mm

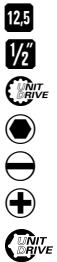

mm

Code	No.	Ratchet	Sockets	Accessories	mm	1
1953974	19 IMU-3	☉ U-3 1993 U-3	☉ 19 10 11 12 13 14 15 17 19 22 24 27 30 ☉ IN 19 5 6 7 8 10 12 14 ☉ IS 19 8 10 ☉ IKS 19 2 3	☐ 1990-5 -10 ☐ 1995	4.7	1
6139750	19 IMU-10	☉ U-10T 1993 U-10 T	☉ 19 10 11 12 13 14 15 17 19 22 24 27 30 ☉ IN 19 5 6 7 8 10 12 14 ☉ IS 19 8 10 ☉ IKS 19 2 3	☐ 1990-5 -10 ☐ 1995	4.8	1
1954008	D 19 IMU-3	☉ U-3 1993 U-3	☉ D 19 10 11 12 13 14 15 17 19 22 24 27 30 ☉ IN 19 5 6 7 8 10 12 14 ☉ IS 19 8 10 ☉ IKS 19 2 3	☐ 1990-5 -10 ☐ 1995	4.7	1
6140090	D 19 IMU-10	☉ U-10T 1993 U-10 T	☉ D 19 10 11 12 13 14 15 17 19 22 24 27 30 ☉ IN 19 5 6 7 8 10 12 14 ☉ IS 19 8 10 ☉ IKS 19 2 3	☐ 1990-5 -10 ☐ 1995	4.7	1

19 CMU / D 19 CMU

SOCKET SET 1/2" 29 pieces

- With forged, tempered hexagon (no.19) or UD profile sockets (no. D 19), hand-operated
- With accessories made from GEDORE vanadium steel 31CrV3
- With reversible with lever change ratchet
- In GEDORIT blue sheet steel case
- Dimensions: 525 x 203 x 50 mm



mm

Code	No.	Ratchet	Sockets	Accessories	mm	mm
6172530	19 CMU-10	1993 U-10 T	19 10 11 12 13 14 15 16 17 18 19 21 22 2 10x11 12x13 14x15 16x17 18x21 19x22 6 10x11 12x13 14x15 16x17 18x21 19x22	1987 1990-5 -10 1995	6.7	1
6172610	D 19 CMU-10	1993 U-10 T	D 19 10 11 12 13 14 15 16 17 18 19 21 22 2 10x11 12x13 14x15 16x17 18x21 19x22 6 10x11 12x13 14x15 16x17 18x21 19x22	1987 1990-5 -10 1995	6.6	1

19 V20U-10

SOCKET SET 1/4" + 1/2" 50 pieces

- With forged, tempered hexagon or UD profile sockets, hand-operated
- With accessories made from GEDORE vanadium steel 31CrV3
- 1/4" with fine toothed, dial change ratchet U-3
- 1/2" with reversible lever change ratchet U-10 T
- In GEDORIT blue sheet steel case
- Dimensions: 525 x 203 x 50 mm



mm

Code	No.	Ratchet	Sockets	Accessories	mm	mm
6157490	19 V20U-10	1993 U-10 T 2093 U-3	19 10 11 12 13 14 15 17 19 22 24 27 30 IN 19 7 8 10 12 14 IS 19 8 10 IKS 19 3 20 4 4,5 5 5,5 6 7 8 9 10 11 13 IN 20 3 4 5 6 IS 20 4 5,5 6,5 IKS 20 1 2	1990-5 -10 1995 2098 2090-2 -4 2087 2095	6.0	1

19 LMU

SOCKET SET 1/2" 30 pieces

- With forged, tempered hexagon sockets, hand-operated
- With accessories made from GEDORE vanadium steel 31CrV3
- With reversible with lever change ratchet
- In GEDORIT blue sheet steel case
- Dimensions: 525 x 203 x 50 mm



mm

Code	No.	Ratchet	Sockets	Accessories	mm	mm
1806033	19 LMU-10	1993 U-10 T	19 10 11 12 13 14 15 16 17 18 19 21 22 24 27 30 32 19L 10 12 13 14 15 17 19 50 MH (20,8) 54 (16)	1987 1990-5 -10 1995	6.6	1

D 19 L-015

SOCKET SET 1/2" 15 pieces

- With forged, tempered UD profile sockets, hand-operated
- In GEDORIT blue sheet steel case
- Dimensions: 320 x 210 x 55 mm

12.5

1/2"



Code	No.	Sockets	12.5	1/2"
2190214	D 19 L-015	● D 19 L 10 12 13 14 15 16 17 18 19 21 22 24 27 30 32	4.3	1

IN 19 LKM

SCREWDRIVER BIT SOCKET SET 1/2" 15 pieces

- For in-hex screws (INBUS*), short and long
- In GEDORIT blue sheet steel case
- Dimensions: 320 x 210 x 55 mm
- INBUS* = reg. trademark of Acument GmbH & Co. OHG, 56567 Neuwied

12.5

1/2"



Code	No.	Sockets	12.5	1/2"
6129360	IN 19 LKM	● IN 19 5 6 7 8 9 10 12 14 17 ● IN 19 L 5-90 6-90 8-90 10-140 12-140 14-140	2.8	1

IN 19 PM

SCREWDRIVER BIT SOCKET SET 1/2" 9 pieces

- For in-hex screws (INBUS*)
- In GEDORIT blue sheet steel case
- Dimensions: 281 x 79 x 35 mm
- INBUS* = reg. trademark of Acument GmbH & Co. OHG, 56567 Neuwied

12.5

1/2"



Code	No.	Sockets	12.5	1/2"
6156250	IN 19 PM	● IN 19 5 6 7 8 9 10 12 14 17	1362	1

INX 19 PM

SCREWDRIVER BIT SOCKET SET 1/2" 9 pieces

- For slotted, cross-head and multi-point screws
- In GEDORIT blue sheet steel case
- Dimensions: 281 x 79 x 35 mm

12.5

1/2"



Code	No.	Sockets	12.5	1/2"
6150050	INX 19 PM	● INX 19 5 6 8 10 12 ⊕ IKS 19 2 3 ⊖ IS 19 12 16	1.3	1

IN 19 Q

SCREWDRIVER BIT SOCKET SET 1/2" 11 pieces

- For in-hex screws (INBUS*)
- In GEDORIT blue sheet steel case
- Dimensions: 318 x 118 x 50 mm
- INBUS* = reg. trademark of Acument GmbH & Co. OHG, 56567 Neuwied

12.5

1/2"



Code	No.	Ratchet	Sockets	Accessories	12.5	1/2"
6156920	IN 19 Q	● U-10T 1993 U-10T	● IN 19 5 6 7 8 9 10 12 14 17	1990-7	2.7	1

ITX 19 PM / ITX 19 B-PM

SCREWDRIVER BIT SOCKET SET 1/2" 9 pieces

- ITX 19 PM: for recessed TORX* head screws
- ITX 19 B-PM: for recessed TORX* head screws with pilot
- In GEDORIT blue sheet steel case
- Dimensions: 281 x 79 x 35 mm
- TORX* = reg. trademark of Acument Intellectual Properties, LLC. USA

12.5

1/2"



Code	No.	Sockets	12.5	1/2"
6158970	ITX 19 PM	● ITX 19 T20 T25 T27 T30 T40 T45 T50 T55 T60	1.2	1
1394894	ITX 19 B-PM	● ITX 19 B T20 T25 T27 T30 T40 T45 T50 T55 T60	1.3	1

ITX 19 LKP

SCREWDRIVER BIT SOCKET SET 1/2" 18 pieces

- For recessed TORX® screws, short and long
- In GEDORIT blue sheet steel case
- Dimensions: 320 x 210 x 55 mm
- TORX® = reg. trademark of Acument Intellectual Properties, LLC. USA



Code	No.	Sockets	12.5	1/2
6138510	ITX 19 LKP	<ul style="list-style-type: none"> ITX 19 T20 T25 T27 T30 T40 T45 T50 T55 T60 ITX 19 L T20 T25 T27 T30 T40 T45 T50 T55 T60 	2.9	1

ITX 19 TX-017

SCREWDRIVER BIT SOCKET SET 1/2" 17 pieces

- For protruding and recessed TORX® screws
- In GEDORIT blue sheet steel case
- Dimensions: 320 x 210 x 55 mm
- TORX® = reg. trademark of Acument Intellectual Properties, LLC. USA



Code	No.	Sockets	12.5	1/2
6129520	ITX 19 TX-017	<ul style="list-style-type: none"> ITX 19 T20 T25 T27 T30 T40 T45 T50 T55 T60 TX 19 E10 E11 E12 E14 E16 E18 E20 E24 	2.0	1

TX 19 E-09

SOCKET SET 1/2" 9 pieces

- For protruding TORX® screws
- In GEDORIT blue sheet steel case
- Dimensions: 281 x 79 x 35 mm
- TORX® = reg. trademark of Acument Intellectual Properties, LLC. USA



Code	No.	Sockets	12.5	1/2
6265970	TX 19 E-09	<ul style="list-style-type: none"> TX 19 E10 E11 E12 E14 E16 E18 E20 E24 3019 	1.0	1

19 TX 20

SCREWDRIVER BIT SOCKET SET 1/2" + 1/4" 34 pieces

- 1/4" and 1/2" sockets for protruding and recessed TORX® screws
- In GEDORIT blue sheet steel case
- Dimensions: 320 x 210 x 55 mm
- TORX® = reg. trademark of Acument Intellectual Properties, LLC. USA

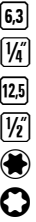

Code	No.	Sockets	6.3	1/4	12.5	1/2
6129440	19 TX 20	<ul style="list-style-type: none"> ITX 19 T40 T45 T50 T55 T60 ITX 19 LT20 T25 T27 T30 T40 T45 T50 T55 T60 TX 19 E12 E14 E16 E18 E20 E24 ITX 20 T8 T9 T10 T15 T20 T25 T27 T30 TX 20 E4 E5 E6 E7 E8 E10 	3.2	1		

ITX 19-20-30 T

SCREWDRIVER BIT SOCKET SET 1/2" 10 pieces

- 1/4", 3/8" and 1/2" sockets for recessed TORX® screws
- In plastic case
- Dimensions: 200 x 120 x 38 mm
- TORX® = reg. trademark of Acument Intellectual Properties, LLC. USA

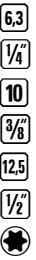

Code	No.	Sockets	6.3	1/4	10	3/8	12.5	1/2
6173500	ITX 19-20-30 T	<ul style="list-style-type: none"> ITX 20 T8 T10 T15 ITX 30 T20 T25 T30 ITX 19 T40 T50 T55 T60 	0.8	1				



Deviant packing units see article description.

VB 19 M / VBD 19 M

DISPLAY BOX 1/2" 192 pieces

- With 192 1/2" sockets
- Supplied with empty insert (EI-VBE 19 L)
- Display box empty (VB 19 L) in GEDORIT silver sheet steel
- Dimensions: 430 x 300 x 220 mm



Code	No.	Sockets	12.5	1/2"
6152340	VB 19 M	S VB 19 M + VB 19 L + EI-VBE 19 L	18.9	1
1888021	SVB 19 M	10x 19 10x 8 9 10 11 12 13 14 8x 15 16 17 18 19 20 21 22 23 24 6x 25 26 27 28 29 30 32	17.0	1
6152260	VBD 19 M	S VBD 19 M + VB 19 L + EI-VBE 19 L	17.6	1
1888048	SVBD 19 M	10x D 19 10x 8 9 10 11 12 13 14 8x 15 16 17 18 19 20 21 22 23 24 6x 25 26 27 28 29 30 32	17.0	1
5152720	VB 19 L		9.0	1
5151080	EI-VBE 19 L		0.1	1



VBI 19 M

DISPLAY BOX 1/2" 152 pieces

- With 152 1/2" screwdriver bit sockets
- Supplied with empty insert (EI-VBE 19 L)
- Display box empty (VBI 19 L) in GEDORIT silver sheet steel
- Dimensions: 430 x 300 x 220 mm



Code	No.	Sockets	12.5	1/2"
6152180	VBI 19 M	S VBI 19 M + VBI 19 L + EI-VBE 19 L	28.0	1
1888056	SVBI 19 M	10x IN 19 6 8 10 8x IN 19 5 12 14 5x IN 19 4 7 9 17 19 5x IS 19 8 10 12 3x IS 19 14 16 18 5x IKS 19 2 3 4 3x IKS 19 PZD 2 3 4 5x INX 19 5 6 8 10 12	24.1	1
5152480	VBI 19 L		9.3	1
5151080	EI-VBE 19 L		0.1	1

VBTX 19

DISPLAY BOX 1/2" 185 pieces

- With 185 protruding and recessed 1/2" TORX® sockets
- Display box empty (VBTX 19 L) in GEDORIT silver sheet steel
- Dimensions: 413 x 275 x 165 mm
- TORX® = reg. trademark of Acument Intellectual Properties, LLC. USA



Code	No.	Sockets	12.5	1/2"
6194260	VBTX 19	S VBTX 19 + VBTX 19 L	20.0	1
1888064	SVBTX 19	10x ITX 19 T20 T25 T27 T30 T40 T45 10x TX 19 E10 E11 E12 E14 E16 5x ITX 19 T50 T55 T60 5x ITX 19 L T20 T25 T27 T30 T40 T45 T50 T55 T60 5x TX 19 E18 E20 E24	19.0	1
6160010	VBTX 19 L		5.3	1

VBE 19 INL

DISPLAY INSERT WITH ASSORTMENT 1/2" 75 pieces

- Includes 75 1/2" screwdriver bit sockets
- Also suitable for VB 19, VBI 19
- Dimensions: 430 x 150 x 35 mm
- EI-VBE 19 L = empty insert

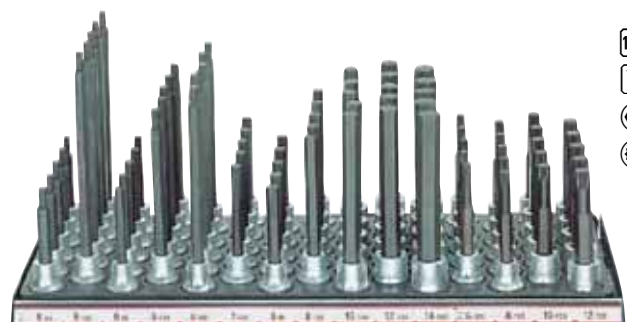

Code	No.	Sockets	12.5	1/2"
6157220	VBE 19 INL	5x IN 19 L 5-90 5-180 6-90 6-140 6-160 7-100 8-90 8-120 10-140 12-140 14-140 5x INX 19 L 6-100 8-100 10-100 12-100	9.9	1
5151080	EI-VBE 19 L		0.1	1

SETS 12.5 MM (1/2") INCH

D 19 WAU







SOCKET SET 1/2" 24 pieces

- ▶ With forged, tempered UD profile sockets, hand-operated
- ▶ With accessories made from GEDORE vanadium steel 31CrV3
- ▶ With fine toothed, dial change ratchet
- ▶ In GEDORIT blue sheet steel case
- ▶ Dimensions: 433 x 180 x 148 mm



12.5
1/2"

 "AF

Code	No.	Ratchet	Sockets	Accessories		
1954024	D 19 WAU-3	 1993 U-3	 D 19 5/16 3/8 13/32 7/16 1/2 9/16 19/32 5/8 11/16 3/4 25/32 13/16 7/8 15/16 1" 1.1/16 1.1/8 1.3/16 1.1/4"	 1987  1990-5 -10  1995	5.1	1

D 19 TA















SOCKET SET 1/2" 25 pieces

- ▶ With forged, tempered hexagon (no.19) or UD profile sockets (no. D 19), hand-operated
- ▶ With accessories made from GEDORE vanadium steel 31CrV3
- ▶ Set U-10T with reversible with lever change ratchet
- ▶ Set Z-94 with ratchet with square coupler
- ▶ In GEDORIT blue sheet steel case
- ▶ Dimensions: 525 x 203 x 50 mm



12.5
1/2"

 "AF

Code	No.	Ratchet	Sockets	Accessories		
6148900	D 19 TAZ	 1993 Z-94	 D 19 5/16 3/8 13/32 7/16 1/2 9/16 19/32 5/8 11/16 3/4 25/32 13/16 7/8 15/16 1" 1.1/16 1.1/8 1.3/16 1.1/4"	 1985  1987  1990-5 -10  1995	6.5	1
6149040	D 19 TAU-10	 1993 U-10T	 D 19 5/16 3/8 13/32 7/16 1/2 9/16 19/32 5/8 11/16 3/4 25/32 13/16 7/8 15/16 1" 1.1/16 1.1/8 1.3/16 1.1/4"	 1985  1987  1990-5 -10  1995	6.6	1

IN 19 PA



SCREWDRIVER BIT SOCKET SET 1/2" 9 pieces

- ▶ For in-hex screws (INBUS®)
- ▶ In GEDORIT blue sheet steel case
- ▶ Dimensions: 281 x 79 x 35 mm
- ▶ INBUS® = reg. trademark of Acument GmbH & Co. OHG, 56567 Neuwied



12.5
1/2"

 "AF

Code	No.	Sockets		
6156410	IN 19 PA	 IN 19 3/16 7/32 1/4 9/32 5/16 3/8 1/2 9/16 5/8"	1328	1

SETS 12.5 MM (1/2") MM+INCH

D 19 XMA

SOCKET SET 1/2" 31 pieces

- With forged, tempered hexagon, bi-hexagon (no.19) or UD profile sockets (no. D 19), hand-operated
- With accessories made from GEDORE vanadium steel 31CrV3
- Set U-10-T with reversible with lever change ratchet
- Set Z-94 with ratchet with square coupler
- In GEDORIT blue sheet steel case
- Dimensions: 433 x 180 x 48 mm



Code	No.	Ratchet	Sockets	Accessories	Weight	Units
6149390	D 19 XMAZ	Z-94 1993 Z-94	<ul style="list-style-type: none"> D 19 11 13 14 17 19 22 24 27 30 32 D 19 3/8 13/32 7/16 1/2 9/16 19/32 5/8 11/16 3/4 25/32 13/16 7/8 15/16 1" 1.1/16 1.1/8" 	<ul style="list-style-type: none"> 1987 1990-5 -10 1995 	5.5	1
6149470	D 19 XMAU-10	U-10-T 1993 U-10-T	<ul style="list-style-type: none"> D 19 11 13 14 17 19 22 24 27 30 32 D 19 3/8 13/32 7/16 1/2 9/16 19/32 5/8 11/16 3/4 25/32 13/16 7/8 15/16 1" 1.1/16 1.1/8" 	<ul style="list-style-type: none"> 1987 1990-5 -10 1995 	5.6	1

SETS 12.5 MM (1/2") MM+INCH+WW

D 19 YMAW

SOCKET SET 1/2" 41 pieces

- With forged, tempered bi-hexagon or UD profile sockets, hand-operated
- With accessories made from GEDORE vanadium steel 31CrV3
- Set U-10-T with reversible with lever change ratchet
- Set Z-94 with ratchet with square coupler
- In GEDORIT blue sheet steel case
- Dimensions: 525 x 203 x 50 mm



Code	No.	Ratchet	Sockets	Accessories	Weight	Units
6149710	D 19 YMAWZ	Z-94 1993 Z-94	<ul style="list-style-type: none"> D 19 10 11 12 13 14 15 16 17 18 19 20 21 22 D 19 L 21 D 19 7/16 1/2 9/16 19/32 5/8 11/16 3/4 25/32 7/8 15/16 1" D 19 3/16 1/4 5/16 3/8 7/16 1/2 9/16 5/8 11/16 3/4 W 	<ul style="list-style-type: none"> 1985 1990-5 -10 1987 1995 	7.4	1
6149980	D 19 YMAWU-10	U-10-T 1993 U-10-T	<ul style="list-style-type: none"> D 19 10 11 12 13 14 15 16 17 18 19 20 21 22 D 19 L 21 D 19 7/16 1/2 9/16 19/32 5/8 11/16 3/4 25/32 7/8 15/16 1" D 19 3/16 1/4 5/16 3/8 7/16 1/2 9/16 5/8 11/16 3/4 W 	<ul style="list-style-type: none"> 1985 1990-5 -10 1987 1995 	7.5	1



20 MM (3/4") SQUARE DRIVE

20 3/4" 20 3/4"

RATCHETS 20 MM (3/4")

3293 U-10

REVERSIBLE RATCHET 3/4"

- ✔ Acc. to DIN 3122, ISO 3315
- ✔ With lever change, locks in middle position
- ✔ Push-fit tube handle
- ✔ For hand-operated sockets and accessories with square drive as per DIN 3120 - D 20, ISO 1174 with locking pin
- ✔ GEDORE vanadium steel 31CrV3, chrome-plated

20
3/4"

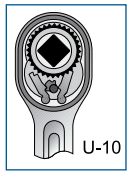
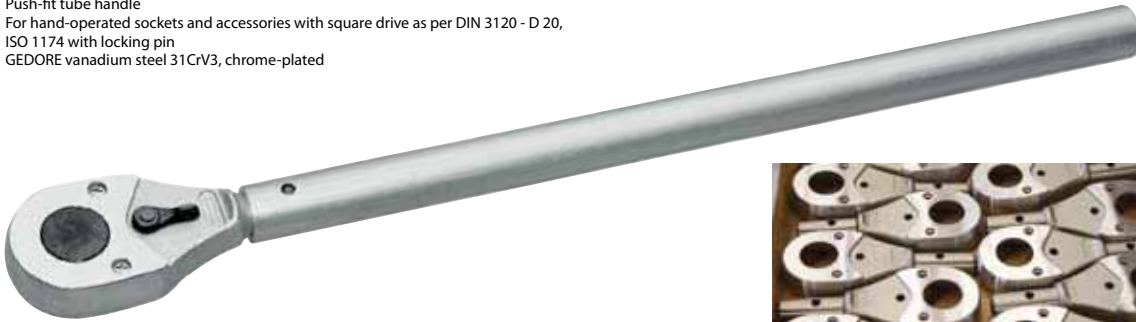

Code	No.	□"	■	∠°	↳mm↳	↳	↳	↳
6277980	3293 U-10	3/4	20	11,25	620	57.5	2630	1

3293 U-2

REVERSIBLE RATCHET 3/4"

- ✔ Acc. to DIN 3122, ISO 3315
- ✔ With disc change, fine-toothed and robust
- ✔ For hand-operated sockets and accessories with square drive as per DIN 3120 - D 20, ISO 1174 with locking pin
- ✔ GEDORE vanadium steel 31CrV3, chrome-plated

20
3/4"

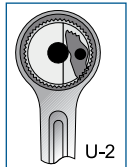

Code	No.	□"	■	∠°	↳mm↳	↳	↳	↳
6278600	3293 U-2	3/4	20	7,2	510	60	1435	1

3293 U-3

REVERSIBLE RATCHET 3/4"

- ✔ Acc. to DIN 3122, ISO 3315
- ✔ With non-slip metal disc change, fine-toothed and robust
- ✔ Push-fit tube handle
- ✔ For hand-operated sockets and accessories with square drive as per DIN 3120 - D 20, ISO 1174, with locking pin
- ✔ GEDORE vanadium steel 31CrV3, chrome-plated

20
3/4"

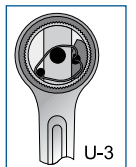

Code	No.	□"	■	∠°	↳mm↳	↳	↳	↳
6278790	3293 U-3	3/4	20	5	620	62.5	2610	1

3293 Z-94

RATCHET HANDLE WITH COUPLER 3/4"

- Acc. to DIN 3122, ISO 3315
- With square coupler, medium-fine toothed, extremely rugged
- For hand-operated sockets and accessories with square drive as per DIN 3120 - D 20, ISO 1174 with locking pin
- GEDORE vanadium steel 31CrV3, chrome-plated

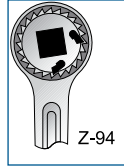
20
3/4

3/4

Code	No.	mm	mm	mm	mm	mm	mm	mm
6278950	3293 Z-94	3/4	20	10	510	31.0	1301	1

SOCKETS 20 MM (3/4")

3/4	UNIT DRIVE hexagon	UNIT DRIVE bi-hexagon	UNIT DRIVE bi-hexagon	UNIT DRIVE hexagon	UNIT DRIVE hexagon	UNIT DRIVE bi-hexagon	Hexagon - external	Hexagon - external	Hexagon - external	Internal hexagon	Internal TORX®	Internal TORX® with pin	External TORX®	Internal serrations XZN	Slot	Cruciform PH	Cruciform PZ	Internal TORX PLUS®	Internal TORX® with ball end	Internal hexagon with ball end	Internal hexagon
	mm	mm	AF	AF	XMMWZ	mm	AF	XMMWZ	mm												AF
	UNIT DRIVE	UNIT DRIVE	UNIT DRIVE	UNIT DRIVE	UNIT DRIVE																
	●	●	●							●	●										

32

SOCKET 3/4" hexagon

- Acc. to DIN 3124, ISO 2725-1
- Square drive as per DIN 3120 - D 20, ISO 1174, with locking pin
- Hand-operated, knurled grip
- GEDORE vanadium steel 31CrV3, chrome-plated, polished
- * not standardised

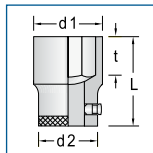
20
3/4

Code	No.	*	mm	L	d ₁	d ₂	t	mm	mm
6269880	32 18	*	18	51.5	28.3	36.0	19.0	219	1
6270110	32 19	*	19	51.5	29.6	36.0	19.0	225	1
6269960	32 21		21	51.5	32.0	36.0	19.0	228	1
6270380	32 22		22	51.5	33.3	36.0	19.0	232	1
6270460	32 24		24	51.5	35.8	38.0	19.5	267	1
6270540	32 27		27	54.5	39.6	36.0	24.0	271	1
6270620	32 29	*	29	54.5	42.0	36.0	23.5	281	1
6270700	32 30		30	57.5	43.3	38.0	26.0	331	1
6270890	32 32		32	57.5	45.8	38.0	27.0	345	1

Code	No.	*	mm	L	d ₁	d ₂	t	mm	mm
6270030	32 33	*	33	57.5	47.0	40.0	26.5	392	1
6279410	32 34		34	57.5	48.3	40.0	26.5	404	1
6270970	32 36		36	59.5	50.8	40.0	28.0	448	1
6271000	32 38	*	38	59.5	53.3	40.5	28.0	476	1
6271190	32 41		41	62.5	57.1	44.0	30.5	593	1
6271270	32 46		46	65.5	63.3	44.0	32.5	700	1
6271350	32 50		50	68.5	68.3	48.0	34.5	848	1
6271430	32 55		55	68.5	74.6	53.0	33.0	1008	1
6271510	32 60		60	68.5	80.8	53.0	33.0	1143	1



D 32

SOCKET 3/4" bi-hexagon UD profile

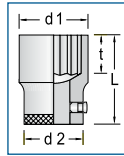

- Acc. to DIN 3124, ISO 2725-1
- Square drive as per DIN 3120 - D 20, ISO 1174, with locking pin
- Hand-operated, knurled grip
- GEDORE vanadium steel 31CrV3, chrome-plated, polished
- * not standardised



 mm

Code	No.	*	Ø mm	L	d ₁	d ₂	t		
6289720	D 32 18	*	18	51.5	28.3	36.0	19.0	211	1
6272160	D 32 19	*	19	51.5	29.6	36.0	19.0	221	1
6289800	D 32 21		21	51.5	32.0	36.0	19.0	223	1
6272240	D 32 22		22	51.5	33.3	36.0	19.0	227	1
6272320	D 32 24		24	51.5	35.8	38.0	19.5	257	1
6272400	D 32 27		27	54.5	39.6	36.0	24.0	255	1
6272590	D 32 29	*	29	54.5	42.0	36.0	23.5	272	1
6272670	D 32 30		30	57.5	43.3	38.0	26.0	319	1
6272750	D 32 32		32	57.5	45.8	38.0	27.0	332	1
6277040	D 32 33	*	33	57.5	47.0	40.0	26.5	358	1
6272830	D 32 36		36	59.5	50.8	40.0	28.0	418	1
6272910	D 32 38	*	38	59.5	53.3	40.5	28.0	441	1
6273050	D 32 41		41	62.5	57.1	44.0	30.5	558	1
6273130	D 32 46		46	65.5	63.3	44.0	32.5	641	1
6273210	D 32 50		50	68.5	68.3	48.0	34.5	800	1
6273480	D 32 55		55	68.5	74.6	53.0	33.0	961	1
6273560	D 32 60		60	68.5	80.8	53.0	33.0	1052	1

 "AF



Code	No.	Ø "AF	L	d ₁	d ₂	t		
6274020	D 32 7/8AF	7/8	51.5	33.6	36.0	19.0	227	1
6274100	D 32 15/16AF	15/16	51.5	35.6	38.0	19.5	262	1
6274290	D 32 1AF	1	51.5	37.6	36.0	22.0	229	1
6274370	D 32 1.1/16AF	1.1/16	54.5	39.6	36.0	24.0	256	1
6274450	D 32 1.1/8AF	1.1/8	54.5	41.5	36.0	24.0	268	1
6274530	D 32 1.1/4AF	1.1/4	57.5	45.5	38.0	27.0	333	1
6274610	D 32 1.5/16AF	1.5/16	57.5	47.5	40.0	26.5	377	1
6274880	D 32 1.3/8AF	1.3/8	59.5	49.5	40.0	28.0	407	1
6274960	D 32 1.7/16AF	1.7/16	59.5	51.4	40.0	28.0	413	1
6275180	D 32 1.1/2AF	1.1/2	59.5	53.3	40.5	28.0	431	1
6275260	D 32 1.5/8AF	1.5/8	62.5	57.4	44.0	30.5	539	1
6275340	D 32 1.11/16AF	1.11/16	62.5	59.4	44.0	30.5	568	1
6275420	D 32 1.3/4AF	1.3/4	65.5	61.4	44.0	32.5	627	1
6275500	D 32 1.13/16AF	1.13/16	65.5	63.3	44.0	32.5	637	1
6275690	D 32 1.7/8AF	1.7/8	65.5	65.3	44.0	32.5	664	1
6275770	D 32 2AF	2	68.5	69.2	48.0	34.5	811	1

IN 32

SCREWDRIVER BIT SOCKET 3/4" for in-hex screws

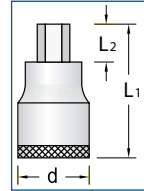
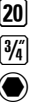
- Acc. to DIN 7422
- Square drive as per DIN 3120 - D 20, ISO 1174, with locking pin
- Hand-operated, knurled grip
- Chrome-plated
- With pressed-in pin in GEDORE vanadium special steel, manganese-phosphated





Code	No.	Ø mm	L ₁	L ₂	d		
6275850	IN 32 14	14	80	25.5	38	352	1
6275930	IN 32 17	17	80	25.5	38	394	1
6276070	IN 32 19	19	80	25.5	38	433	1
6276150	IN 32 22	22	80	25.5	38	482	1

IN 32 L

SCREWDRIVER BIT SOCKET 3/4" for in-hex screws, long pattern

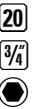
- Acc. to DIN 7422
- Square drive as per DIN 3120 - D 20, ISO 1174, with locking pin
- Hand-operated, knurled grip
- Chrome-plated
- With pressed-in pin in GEDORE vanadium special steel, manganese-phosphated





Code	No.	Ø mm	L ₁	L ₂	d		
2003503	IN 32 L 14-155	14	155	100	38	452	1
1353705	IN 32 L 17-155	17	155	100	38		1
2003511	IN 32 L 19-155	19	155	100	38		1
2003538	IN 32 L 22-155	22	155	100	38		1

ITX 32

SCREWDRIVER BIT SOCKET 3/4" for recessed TORX® head screws

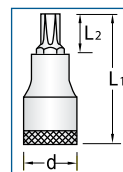
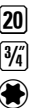
- Square drive as per DIN 3120 - D 20, ISO 1174, with locking pin
- Hand-operated, knurled grip
- Chrome-plated
- With pressed-in pin in GEDORE vanadium special steel, gun-metal finish
- TORX® = reg. trademark of Acument Intellectual Properties, LLC. USA



Code	No.	Ø	mm	L ₁	L ₂	d			
6271780	ITX 32 T60	T60	M14	13.25	80	25.5	38	346	1
6272080	ITX 32 T70	T70	M16	15.55	80	25.5	38	383	1
6273640	ITX 32 T80	T80	M18	17.58	80	25.5	38	416	1
6276230	ITX 32 T90	T90	M20	19.95	80	25.5	38	455	1
6276310	ITX 32 T100	T100	M22	21.16	80	25.5	38	461	1



ACCESSORIES 20 MM (3/4")

3219

REDUCER 3/4" TO 1/2"

- Acc. to DIN 3123, ISO 3316
- For hand-operated sockets with square drive as per DIN 3120, ISO 1174, with locking pin
- GEDORE vanadium steel 31CrV3, chrome-plated

20
3/4"
12,5
1/2"



Code	No.	□"	□	■"	■	↳mm↳	↕	📦
6278010	3219	3/4	20	1/2	12,5	56	168	1

3221

CONVERTOR 3/4" TO 1"

- Acc. to DIN 3123, ISO 3316
- For hand-operated sockets with square drive as per DIN 3120, ISO 1174, with locking pin
- GEDORE vanadium steel 31CrV3, chrome-plated

20
3/4"
25
1"



Code	No.	□"	□	■"	■	↳mm↳	↕	📦
6278280	3221	3/4	20	1	25	60	337	1

3287

SLIDING T BAR 3/4"

- Acc. to DIN 3122, ISO 3315
- For hand-operated sockets with square drive as per DIN 3120, ISO 1174, with locking pin
- GEDORE vanadium steel 31CrV3, chrome-plated

20
3/4"



Code	No.	■"	■	↳mm↳	↕	📦
6278360	3287	3/4	20	500	1161	1

3290

EXTENSION 3/4"

- Acc. to DIN 3123, ISO 3316
- For hand-operated sockets with square drive as per DIN 3120, ISO 1174, with locking pin
- GEDORE vanadium steel 31CrV3, chrome-plated

20
3/4"



Code	No.	■"	■	↳mm↳	↕	📦
6278440	3290-8	3/4	20	200	574	1
6278520	3290-16	3/4	20	400	1079	1

3294

COUPLER 3/4"

- Acc. to DIN 3122, ISO 3315
- For hand-operated sockets with square drive as per DIN 3120, ISO 1174, with locking pin
- GEDORE vanadium steel 31CrV3, chrome-plated

20
3/4"



Code	No.	■"	■	↳mm↳	↕	📦
6279090	3294	3/4	20	51,5	133	1

3295

UNIVERSAL JOINT 3/4"

- Acc. to DIN 3123, ISO 3316
- For hand-operated sockets with square drive as per DIN 3120, ISO 1174, with locking pin
- GEDORE vanadium steel 31CrV3, chrome-plated

20
3/4"



Code	No.	■"	■	□"	□	↳mm↳	↕	📦
6279170	3295	3/4	20	3/4	20	108	580	1

3296

SWIVEL HANDLE 3/4"

- Acc. to DIN 3122, ISO 3315
- For hand-operated sockets with square drive as per DIN 3120, ISO 1174, with locking pin
- GEDORE vanadium steel 31CrV3, chrome-plated

20
3/4"



Code	No.	■"	■	↳mm↳	↕	📦
6279250	3296	3/4	20	547	1965	1

SETS 20 MM (3/4") METRIC

20 3/4"

32 EM / D 32 EM

SOCKET SET 3/4" 14 pieces

- ✔ With forged, tempered hexagon (no.32) or UD profile sockets (no. D 32), hand-operated
- ✔ With accessories made from GEDORE vanadium steel 31CrV3
- ✔ Set U-2 with fine toothed, dial change ratchet
- ✔ Set Z-94 with ratchet with square coupler
- ✔ In GEDORIT blue sheet steel case
- ✔ Dimensions: 525 x 203 x 73 mm



3/4"



20
3/4"
FIT FIVE
FIT FIVE

mm

Code	No.	Ratchet	Sockets	Accessories	mm	📦
6280180	32 EMZ	⊗ Z-94 3293 Z-94	⊗ 32 22 24 27 30 32 36 38 41 46 50	→ 3287 → 3290-8 -16	11.4	1
6280340	32 EMU-2	⊗ U-2 3293 U-2	⊗ 32 22 24 27 30 32 36 38 41 46 50	→ 3287 → 3290-8 -16	11.6	1
6280260	D 32 EMZ	⊗ Z-94 3293 Z-94	⊗ D 32 22 24 27 30 32 36 38 41 46 50	→ 3287 → 3290-8 -16	11.2	1
6280420	D 32 EMU-2	⊗ U-2 3293 U-2	⊗ D 32 22 24 27 30 32 36 38 41 46 50	→ 3287 → 3290-8 -16	11.1	1

32 FM / D 32 FM

SOCKET SET 3/4" 16 pieces

- ✔ With forged, tempered hexagon, bi-hexagon (no.32) or UD profile sockets (no. D 32), hand-operated
- ✔ With accessories made from GEDORE vanadium steel 31CrV3
- ✔ Set U-2 with fine toothed, dial change ratchet
- ✔ Set Z-94 with ratchet with square coupler
- ✔ In GEDORIT blue sheet steel case
- ✔ Dimensions: 555 x 230 x 80 mm

20
3/4"
FIT FIVE
FIT FIVE



mm

Code	No.	Ratchet	Sockets	Accessories	mm	📦
6280930	32 FMZ	⊗ Z-94 3293 Z-94	⊗ 32 22 24 27 30 32 36 38 41 46 50 55 60	→ 3287 → 3290-8 -16	15.6	1
6281150	32 FMU-2	⊗ U-2 3293 U-2	⊗ 32 22 24 27 30 32 36 38 41 46 50 55 60	→ 3287 → 3290-8 -16	15.8	1
6281070	D 32 FMZ	⊗ Z-94 3293 Z-94	⊗ D 32 22 24 27 30 32 36 38 41 46 50 55 60	→ 3287 → 3290-8 -16	15.1	1
6281230	D 32 FMU-2	⊗ U-2 3293 U-2	⊗ D 32 22 24 27 30 32 36 38 41 46 50 55 60	→ 3287 → 3290-8 -16	15.2	1



➔ **8563-30 D**



242



SETS 20 MM (3/4") INCH

D 32 EA

SOCKET SET 3/4" 14 pieces

- With forged, tempered hexagon (no.32) or UD profile sockets (no. D 32), hand-operated
- With accessories made from GEDORE vanadium steel 31CrV3
- Set U-2 with fine toothed, dial change ratchet
- Set Z-94 with ratchet with square coupler
- In GEDORIT blue sheet steel case
- Dimensions: 525 x 203 x 73 mm

20
3/4"

"AF"

Code	No.	Ratchet	Sockets	Accessories	mm	mm
6280500	D 32 EAZ	☉ Z-94 3293 Z-94	☉ D 32 15/16 1.1/16 1.1/8 1.1/4 1.5/16 1.3/8 1.1/2 1.5/8 1.7/8 2"	☞ 3287 ☞ 3290-8 -16	11.3	1
6280690	D 32 EAU-2	☉ U-2 3293 U-2	☉ D 32 15/16 1.1/16 1.1/8 1.1/4 1.5/16 1.3/8 1.1/2 1.5/8 1.7/8 2"	☞ 3287 ☞ 3290-8 -16	11.3	1

SETS 20 MM (3/4") MM+INCH

D 32 EMAU-2

SOCKET SET 3/4" 25 pieces

- With forged, tempered UD profile sockets, hand-operated
- With accessories made from GEDORE vanadium steel 31CrV3
- With fine toothed, dial change ratchet
- In GEDORIT blue sheet steel case
- Dimensions: 660 x 230 x 80 mm

20
3/4"

mm

"AF"

Code	No.	Ratchet	Sockets	Accessories	mm	mm
6281310	D 32 EMAU-2	☉ U-2 3293 U-2	☉ D 32 22 24 27 30 32 36 41 46 50 ☉ D 32 7/8 15/16 1" 1.1/16 1.1/8 1.1/4 1.5/16 1.3/8 1.1/2 1.11/16 1.7/8 2"	☞ 3287 ☞ 3290-8 -16	18.2	1



8563-10 D

240
241

25 MM (1") SQUARE DRIVE

25 1" 25 1"

RATCHETS 25 MM (1")

2193 U-10

REVERSIBLE RATCHET 1"

- ✔ Acc. to DIN 3122, ISO 3315
- ✔ With lever change, locks in middle position
- ✔ Push-fit bar handle no. 2187 G
- ✔ For hand-operated sockets and accessories with square drive as per DIN 3120 - D 25, ISO 1174 with locking pin
- ✔ GEDORE vanadium steel 31CrV3, chrome-plated

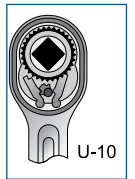

25 1"

Code	No.	Execution	■"	■	∠°	↳mm↳	←	↕	📦
6180550	2193 U-10	complete	1	25	11,25	810	61.5	5210	1
6196120	2193 U-10 K	head only	1	25		184	61.5	1980	1
6195900	2187 G	tommy bar				700		3275	1

2193 U-3

REVERSIBLE RATCHET 1"

- ✔ Acc. to DIN 3122, ISO 3315
- ✔ With non-slip metal disc change, fine-toothed and robust
- ✔ Push-fit tube handle
- ✔ For hand-operated sockets and accessories with square drive as per DIN 3120 - D 25, ISO 1174, with locking pin
- ✔ GEDORE vanadium steel 31CrV3, chrome-plated

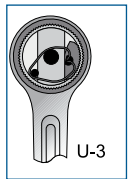

25 1"

Code	No.	Execution	■"	■	∠°	↳mm↳	←	↕	📦
6180630	2193 U-3	complete	1	25	5	720	76	4160	1
1637487	2193 U-3 K	head only	1	25				2000	1
1382500	2193 Z/17	tube						2175	1

2193 Z-94

RATCHET HANDLE WITH COUPLER 1"

- ✔ Acc. to DIN 3122, ISO 3315
- ✔ With square coupler, medium-fine toothed, extremely rugged
- ✔ Push-fit tube handle
- ✔ For hand-operated sockets and accessories with square drive as per DIN 3120 - D 25, ISO 1174 with locking pin
- ✔ GEDORE vanadium steel 31CrV3, chrome-plated

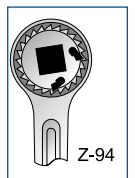

25 1"

Code	No.	Execution	■"	■	∠°	↳mm↳	←	↕	📦
6181520	2193 Z-94	complete	1	25	9	720	41	4115	1
1493779	2193 Z K	head only	1	25				1175	
1382500	2193 Z/17	tube						2175	1

SOCKETS 25 MM (1")

D 21

SOCKET 1" bi-hexagon UD profile

- Acc. to DIN 3124, ISO 2725-1
- Square drive as per DIN 3120 - D 25, ISO 1174, with locking pin
- Hand-operated, knurled grip
- GEDORE vanadium steel 31CrV3, chrome-plated
- * not standardised

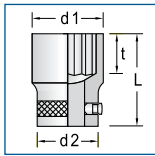

Code	No.	*	Ømm	L	d ₁	d ₂	t	↕	☒
6174900	D 21 36	*	36	70.0	53.9	48.0	30.0	600	1
6175040	D 21 41		41	70.0	60.1	50.0	30.5	688	1
6175120	D 21 46		46	75.0	66.4	50.0	33.5	842	1
6175200	D 21 50		50	75.0	71.4	50.0	35.0	908	1
6175390	D 21 55		55	80.0	77.6	50.0	37.5	1129	1
6175470	D 21 60		60	85.0	83.9	50.0	41.0	1376	1
6175550	D 21 65		65	88.0	90.1	59.5	44.5	1700	1
6175630	D 21 70		70	92.0	96.4	59.5	48.0	1984	1
6175710	D 21 75		75	95.0	102.6	59.5	51.0	2225	1
6175980	D 21 80		80	97.0	108.9	59.5	54.0	2454	1



Code	No.	ØAF	L	d ₁	d ₂	t	↕	☒
6176440	D 21 1.7/16AF	1.7/16	70.0	54.5	48.0	30.0	608	1
6176520	D 21 1.1/2AF	1.1/2	70.0	56.5	48.0	30.0	649	1
6176600	D 21 1.5/8AF	1.5/8	70.0	60.1	50.0	30.5	701	1
6176870	D 21 1.13/16AF	1.13/16	75.0	66.4	50.0	33.5	835	1
6176950	D 21 1.7/8AF	1.7/8	75.0	68.4	50.0	33.5	890	1
6177090	D 21 2AF	2	75.0	72.4	50.0	35.0	944	1
6177170	D 21 2.1/16AF	2.1/16	75.0	74.0	50.0	35.0	987	1
6177250	D 21 2.3/16AF	2.3/16	80.0	78.3	50.0	37.5	1181	1
6177330	D 21 2.1/4AF	2.1/4	80.0	80.3	50.0	37.5	1230	1
6177410	D 21 2.3/8AF	2.3/8	85.0	83.9	50.0	41.0	1398	1
6177680	D 21 2.7/16AF	2.7/16	85.0	86.2	50.0	41.0	1544	1
6177760	D 21 2.9/16AF	2.9/16	88.0	90.1	59.5	44.5	1788	1
6177840	D 21 2.5/8AF	2.5/8	88.0	92.2	59.5	44.5	1813	1
6177920	D 21 2.3/4AF	2.3/4	92.0	96.4	59.5	48.0	2065	1
6178060	D 21 2.13/16AF	2.13/16	92.0	98.2	59.5	48.0	2140	1
6178140	D 21 2.15/16AF	2.15/16	95.0	102.6	59.5	51.0	2307	1
6178220	D 21 3AF	3	95.0	104.1	59.5	51.0	2349	1
6178300	D 21 3.1/8AF	3.1/8	97.0	108.9	59.5	54.0	2556	1



Code	No.	ØWhitw.	L	d ₁	d ₂	t	↕	☒
6178650	D 21 7/8W	7/8	70.0	55.8	48.0	30.0	648	1
6178730	D 21 15/16W	15/16	70.0	58.6	50.0	30.0	734	1
6178810	D 21 1W	1	70.0	61.9	50.0	30.5	726	1
6179030	D 21 1.1/8W	1.1/8	75.0	67.9	50.0	33.5	882	1
6179110	D 21 1.1/4W	1.1/4	75.0	74.0	50.0	35.0	982	1
6179380	D 21 1.3/8W	1.3/8	80.0	79.3	50.0	37.5	1139	1
6179460	D 21 1.1/2W	1.1/2	85.0	85.1	50.0	41.0	1551	1
6179540	D 21 1.5/8W	1.5/8	88.0	90.8	59.5	44.5	1594	1
6179620	D 21 1.3/4W	1.3/4	92.0	96.4	59.5	48.0	1876	1
6179700	D 21 2W	2	97.0	108.9	59.5	54.0	2434	1

IN 21

SCREWDRIVER BIT SOCKET 1" for in-hex screws

- Acc. to DIN 7422
- Square drive as per DIN 3120 - D 25, ISO 1174, with locking pin
- Hand-operated, knurled grip
- Chrome-plated
- With pressed-in pin in GEDORE vanadium special steel, manganese-phosphated
- * not standardised

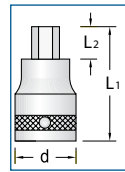

Code	No.	*	Ømm	L ₁	L ₂	d	↕	☒
6181010	IN 21 17		17	90	25.5	48	613	1
6181280	IN 21 19		19	90	25.5	48	676	1
6181360	IN 21 22		22	90	25.5	48	733	1
6181440	IN 21 24		24	90	25.5	48	784	1
6200680	IN 21 27	*	27	90	25.5	48	856	1

ACCESSORIES 25 MM (1")

2132

REDUCER 1" TO 3/4"

- Acc. to DIN 3123, ISO 3316
- For hand-operated sockets with square drive as per DIN 3120, ISO 1174, with locking pin
- GEDORE vanadium steel 31CrV3, chrome-plated



Code	No.	□*	□	■*	■	↳mm↳	↕	☒
6180040	2132	1	25	3/4	20	75	504	1

2187

SLIDING T BAR 1"

- Acc. to DIN 3122, ISO 3315
- For hand-operated sockets with square drive as per DIN 3120, ISO 1174, with locking pin
- GEDORE vanadium steel 31CrV3, chrome-plated



Code	No.	Execution	■*	■	↳mm↳	↕	☒
6180120	2187	complete	1	25	700	3955	1
6196040	2187 K	drive piece	1	25	80	680	1
6195900	2187 G	tommy bar			700	3275	1

2190

EXTENSION 1"

- Acc. to DIN 3123, ISO 3316
- For hand-operated sockets with square drive as per DIN 3120, ISO 1174, with locking pin
- GEDORE vanadium steel 31CrV3, chrome-plated

25
1"

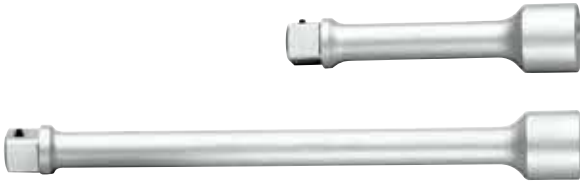

Code	No.	■"	■	↳mm↳	↕	📦
6180200	2190-8	1	25	200	1182	1
6180390	2190-16	1	25	400	2144	1

2194

COUPLER 1"

- Acc. to DIN 3122, ISO 3315
- For hand-operated sockets with square drive as per DIN 3120, ISO 1174, with locking pin
- GEDORE vanadium steel 31CrV3, chrome-plated

25
1"



Code	No.	■"	■	↳mm↳	↕	📦
6180710	2194	1	25	67.5	321	1

2195

UNIVERSAL JOINT 1"

- For hand-operated sockets with square drive as per DIN 3120, ISO 1174, with locking pin
- GEDORE vanadium steel 31CrV3, chrome-plated

25
1"



Code	No.	■"	■	□"	□	↳mm↳	↕	📦
6180980	2195	1	25	1	25	140	1482	1

SETS 25 MM (1") METRIC

25 1"

D 21 EMU-10





SOCKET SET 1" 15 pieces

- With forged, tempered UD profile sockets, hand-operated
- With accessories made from GEDORE vanadium steel 31CrV3
- With reversible lever change ratchet
- In GEDORIT blue sheet steel case
- Dimensions: 765 x 289 x 105 mm





25
1" 









 mm

Code	No.	Ratchet	Sockets	Accessories	↕	📦
6181600	D 21 EMU-10	 U-10 K 2193 U-10 K	 D 21 36 41 46 50 55 60 65 70 75 80	 2190-8 -16  2187 G  2187 K	31.4	1

 "AF

Code	No.	Ratchet	Sockets	Accessories	↕	📦
6181790	D 21 EAU-10	 U-10 K 2193 U-10 K	 D 21 7/8 1.1/2 1.5/8 1.7/8 2 2.1/16 2.1/4 2.3/8 2.9/16 2.3/4 3"	 2190-8 -16  2187 G  2187 K	34.9	1

 Whitw.

Code	No.	Ratchet	Sockets	Accessories	↕	📦
6181870	D 21 EWU-10	 U-10 K 2193 U-10 K	 D 21 7/8 15/16 1 1.1/8 1.1/4 1.3/8 1.1/2 1.5/8 1.3/4 2W	 2190-8 -16  2187 G  2187 K	34.9	1



FRICITION TYPE RATCHETS

31 KR

FRICITION TYPE RATCHET with ring UD profile or bi-hexagon

- Friction spanner (31 K) with exchangeable UD profile or bi-hexagon insert rings (31 R)
- Hexagon rings are available on request
- Flat shaft up to 30", push-fit tube handle from 35"
- GEDORE vanadium steel 31CrV3, manganese-phosphated
- Explanation of the article number: 31 KR 16-32 = ratchet 31 K 16" and insert ring 31 R 32 mm

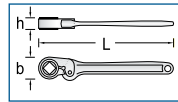

Code	No.	Ømm	L	L"	h	b	↕	⊞
6253020	31 KR 6-8	8	150	6	11.5	23.0	93	1
6253100	31 KR 6-9	9	150	6	11.5	23.0	90	1
6253290	31 KR 6-10	10	150	6	11.5	23.0	88	1
6253370	31 KR 6-11	11	150	6	11.5	23.0	86	1
6253450	31 KR 6-12	12	150	6	11.5	23.0	84	1
6253530	31 KR 6-13	13	150	6	11.5	23.0	82	1
6253610	31 KR 8-14	14	205	8	15.5	31.2	224	1
6253880	31 KR 8-15	15	205	8	15.5	31.2	220	1
6253960	31 KR 8-16	16	205	8	15.5	31.2	216	1
6254180	31 KR 8-17	17	205	8	15.5	31.2	212	1
6254260	31 KR 10-18	18	255	10	17.5	38.0	352	1
6254340	31 KR 10-19	19	255	10	17.5	38.0	346	1
6254500	31 KR 10-21	21	255	10	17.5	38.0	336	1
6254690	31 KR 10-22	22	255	10	17.5	38.0	330	1
6254770	31 KR 10-23	23	255	10	17.5	38.0	324	1
6254850	31 KR 12-24	24	305	12	18.5	44.6	497	1
6255070	31 KR 12-26	26	305	12	18.5	44.6	482	1
6255150	31 KR 12-27	27	305	12	18.5	44.6	474	1
6255230	31 KR 12-28	28	305	12	18.5	44.6	466	1
6255580	31 KR 16-30	30	400	16	19.5	51.6	709	1
6255740	31 KR 16-32	32	400	16	19.5	51.6	684	1
6262600	31 KR 20-34	34	500	20	21.5	63.6	1184	1
6256120	31 KR 20-36	36	500	20	21.5	63.6	1162	1
6256470	31 KR 20-41	41	500	20	21.5	63.6	1098	1
6256550	31 KR 25-46	46	635	25	31.5	78.1	2302	1
6256630	31 KR 25-50	50	635	25	31.5	78.1	2213	1
6256710	31 KR 30-55	55	760	30	33.5	92.0	3011	1
6256980	31 KR 30-60	60	760	30	33.5	92.0	2879	1
6257010	31 KR 35-65	65	940	35	36.5	105.0	7204	1
6257280	31 KR 35-70	70	940	35	36.5	105.0	7023	1
6257360	31 KR 40-75	75	960	40	39.5	118.0	7643	1
6257440	31 KR 40-80	80	960	40	39.5	118.0	7392	1
6257520	31 KR 45-85	85	1150	45	46.0	133.0	9790	1
6257600	31 KR 45-90	90	1150	45	46.0	133.0	9479	1
6257790	31 KR 55-95	95	1400	55	55.0	160.0	16370	1
6257870	31 KR 55-100	100	1400	55	55.0	160.0	15970	1
6257950	31 KR 55-105	105	1400	55	55.0	160.0	15535	1
6258090	31 KR 60-110	110	1500	60	57.0	169.0	17122	1
6258170	31 KR 60-115	115	1500	60	57.0	169.0	16606	1



Deviant packing units see article description.

31 KVR

FRICITION TYPE RATCHET with square ring

- Friction spanner (31 K) with exchangeable square insert rings (31 VR)
- GEDORE vanadium steel 31CrV3, manganese-phosphated
- Explanation of the article number: 31 KVR 8-12 = ratchet 31 K 8" and insert ring 31 VR 12 mm

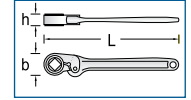

Code	No.	Ømm	L	L"	h	b	↕	⊞
6266000	31 KVR 6-8	8	150	6	11.5	23.0	91	1
6266190	31 KVR 6-9	9	150	6	11.5	23.0	89	1
6266270	31 KVR 6-10	10	150	6	11.5	23.0	87	1
6266350	31 KVR 6-11	11	150	6	11.5	23.0	85	1
6266430	31 KVR 8-12	12	205	8	15.5	31.2	228	1
6266780	31 KVR 8-14	14	205	8	15.5	31.2	221	1
6267080	31 KVR 10-17	17	255	10	17.5	38.0	353	1
6267240	31 KVR 10-19	19	255	10	17.5	38.0	346	1

31 K

FRICITION RATCHET HANDLE WITHOUT INSERT RING

- Friction spanner for insert rings 31 R and 31 VR
- GEDORE vanadium steel 31CrV3, manganese-phosphated



Code	No.	Ø Ring	Ø Ring	L	L"	Head Ø	↕	⊞
6243060	31 K 6	8-13	8-11	150	6	20	70	1
6243140	31 K 8	14-17	12-14	205	8	28	176	1
6243220	31 K 10	18-23	17-19	255	10	34	277	1
6243300	31 K 12	24-28		305	12	40	406	1
6243490	31 K 16	30-32		400	16	46	600	1
6243570	31 K 20	34-41		500	20	57	961	1
6243650	31 K 25	46-50		635	25	70	1880	1
6243730	31 K 30	55-60		760	30	82	2435	1
6243810	31 K 35	65-70		940	35	96	6305	1
6244030	31 K 40	75-80		960	40	108	6480	1
6244110	31 K 45	85-90		1150	45	120	8245	1
6244460	31 K 55	95-105		1400	55	145	13015	1
6244540	31 K 60	110-115		1500	60	153	14100	1

31 R



INSERT RING FOR FRICITION RATCHET UD profile or bi-hexagon

- GEDORE vanadium steel 31CrV3, manganese-phosphated



Code	No.	Ø	Ø	↕	↕	⊞
6245000	31 R 8	8	19.7	6	21	1
6245190	31 R 9	9	19.7	6	20	1
6245270	31 R 10	10	19.7	6	18	1
6245350	31 R 11	11	19.7	6	16	1
6245430	31 R 12	12	19.7	6	13	1
6245510	31 R 13	13	19.7	6	11	1
6245780	31 R 14	14	27.6	8	47	1



Code	No.	O	Ø			
6245860	31 R 15	15	27.6	8	44	1
6245940	31 R 16	16	27.6	8	40	1
6246080	31 R 17	17	27.6	8	36	1
6246160	31 R 18	18	33.6	10	75	1
6246240	31 R 19	19	33.6	10	69	1
6246400	31 R 21	21	33.6	10	59	1
6246590	31 R 22	22	33.6	10	53	1
6246670	31 R 23	23	33.6	10	47	1
6246750	31 R 24	24	39.6	12	91	1
6246910	31 R 26	26	39.6	12	76	1
6247050	31 R 27	27	39.6	12	69	1
6247130	31 R 28	28	39.6	12	61	1
6247480	31 R 30	30	45.6	16	109	1
6247640	31 R 32	32	45.6	16	84	1
6240040	31 R 34	34	56.6	20	223	1
6248020	31 R 36	36	56.6	20	201	1
6248370	31 R 41	41	56.6	20	137	1
6248450	31 R 46	46	70.0	25	422	1
6248530	31 R 50	50	70.0	25	333	1
6248610	31 R 55	55	82.0	30	576	1
6248880	31 R 60	60	82.0	30	444	1
6248960	31 R 65	65	96.0	35	899	1
6249180	31 R 70	70	96.0	35	718	1
6249260	31 R 75	75	108.0	40	1163	1
6249340	31 R 80	80	108.0	40	912	1
6249420	31 R 85	85	120.0	45	1545	1
6249500	31 R 90	90	120.0	45	1234	1
6249690	31 R 95	95	145.0	55	3355	1
6249770	31 R 100	100	145.0	55	2955	1
6249850	31 R 105	105	145.0	55	2520	1
6249930	31 R 110	110	153.0	60	3022	1
6250000	31 R 115	115	153.0	60	2506	1





29

CONSTRUCTION RATCHET bi-hexagon

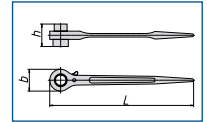
Reversible ratchet with two different size heads, bi-hexagon and "rat-tail" handle



Code	No.	O mm	L	h	b		
1648934	29 17x19	17 x 19	315	49.0	42.0	463	1
1382853	29 19x22	19 x 22	315	49.5	42.0	448	1
1648926	29 19x24	19 x 24	365	56.0	51.5	757	1
6262790	29 24x30	24 x 30	402	63.0	61.0	1378	1
6262950	29 27x32	27 x 32	402	63.0	61.0	1278	1
6263170	29 36x41	36 x 41	495	74.0	76.0	1377	1

41 - 41 B

REVERSIBLE LEVER CHANGE RATCHET





With permanently fixed UD profile insert
GEDORE vanadium steel 31CrV3, chrome-plated



41



41 B



Code	No.	∠°	G	mm 	mm 		
6338790	41 22	11,25	22	27.9	620	2455	1
6338870	41 24	11,25	24	27.9	620	2430	1
6338950	41 27	11,25	27	27.9	620	2410	1
6330030	41 28	11,25	28	27.9	620	2393	1
6339170	41 30	11,25	30	27.9	620	2365	1
6339250	41 32	11,25	32	27.9	620	2330	1
6338360	41 B 36	15,00	36	43.0	910	5025	1
6338440	41 B 41	15,00	41	43.0	910	4895	1
6338520	41 B 46	15,00	46	43.0	910	4725	1

31 VR

INSERT RING FOR FRICTION RATCHET square

GEDORE vanadium steel 31CrV3, manganese-phosphated



Code	No.	O	Ø			
6261200	31 VR 8	8	19.7	6	21	1
6261390	31 VR 9	9	19.7	6	18	1
6261470	31 VR 10	10	19.7	6	17	1
6261550	31 VR 11	11	19.7	6	15	1
6261630	31 VR 12	12	27.6	8	52	1
6261980	31 VR 14	14	27.6	8	45	1
6262360	31 VR 17	17	33.6	10	76	1
6262520	31 VR 19	19	33.6	10	69	1



31 K



209





41 V - 41 BV

REVERSIBLE LEVER CHANGE RATCHET

With permanently fixed square insert
GEDORE vanadium steel 31CrV3, chrome-plated



Code	No.	∠°	O	mm 	mm 		
6339410	41 V 19	11,25	19	27.9	620	2475	1
6339680	41 V 22	11,25	22	27.9	620	2450	1
6339760	41 V 24	11,25	24	27.9	620	2420	1
6339840	41 V 27	11,25	27	27.9	620	2385	1
6338600	41 BV 30	15,00	30	43.0	910	5115	1
6339330	41 BV 32	15,00	32	43.0	910	5075	1
6339920	41 BV 36	15,00	36	43.0	910	4970	1

IMPACT TOOLS

6.3 MM (1/4") SQUARE DRIVE

K 20

IMPACT SOCKET 1/4" hexagon METRIC

- Acc. to DIN 3129, ISO 2725-2
- Suitable for all standard electric and air tools
- Square drive as per DIN 3121 - G 6.3, ISO 1174
- GEDORE special steel, gun-metal finish
- * not standardised

6.3

1/4"

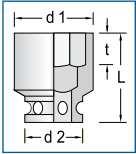

mm

Code	No.	*	mm	L	d ₁	d ₂	t	mm	mm
6198090	K 20 5,5		5.5	23	9.5	13	3	16	1
6198170	K 20 6		6.0	23	10.0	13	3	16	1
6198250	K 20 7		7.0	23	11.3	13	3	16	1
6198330	K 20 8		8.0	23	12.5	13	4	16	1
6198410	K 20 9		9.0	23	13.8	13	4	17	1
6198680	K 20 10		10.0	23	15.0	13	5	18	1
6198760	K 20 11		11.0	23	16.3	13	5	20	1
6198840	K 20 12		12.0	23	17.0	13	6	23	1
6198920	K 20 13		13.0	23	18.8	13	6	24	1
6199060	K 20 14	*	14.0	25	20.0	13	7	35	1
6199140	K 20 17	*	17.0	26	23.8	13	7	37	1

"AF

Code	No.	"AF	L	d ₁	d ₂	t	mm	mm
6199220	K 20 3/16AF	3/16	23	8.5	13	3	15	1
6199300	K 20 1/4AF	1/4	23	10.3	13	3	17	1
6199490	K 20 5/16AF	5/16	23	12.5	13	3	16	1
6199570	K 20 3/8AF	3/8	23	15.0	13	4	18	1
6199650	K 20 7/16AF	7/16	23	16.3	13	6	21	1

KB 2090

EXTENSION 1/4" for impact sockets

- With square drive as per DIN 3121 - G 6.3, ISO 1174
- GEDORE special steel, gun-metal finish

6.3

1/4"



Code	No.	"	mm	mm	mm	mm
6201140	KB 2090-2	1/4	6.3	50	26	1

Securing with pin and ring



KB 2070 - KB 2075

SAFETY RING AND SAFETY PIN for impact sockets 1/4"

6.3

1/4"

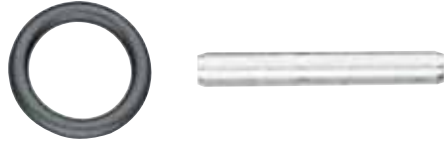

Code	No.	Description	mm	mm	mm	mm
6200920	KB 2070	Safety ring d 9 mm	9.0	5	1	
6201060	KB 2075	Safety pin d 1.5 mm	1.5	10	5	1

10 MM (3/8") SQUARE DRIVE

K 30

IMPACT SOCKET 3/8" hexagon

- Acc. to DIN 3129, ISO 2725-2
- Suitable for all standard electric and air tools
- Square drive as per DIN 3121 - G 10, ISO 1174
- GEDORE special steel, gun-metal finish
- * not standardised

10

3/8"

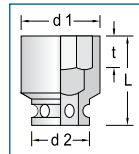

Code	No.	*	mm	L	d ₁	d ₂	t	mm	mm
6251160	K 30 6	*	6	30	11.0	19	3.0	45	5
6251240	K 30 7		7	30	12.5	19	3.0	46	5
6251320	K 30 8		8	30	14.5	19	4.0	46	5
6251400	K 30 9		9	30	15.0	19	4.0	46	1
6251590	K 30 10		10	30	16.0	19	5.0	46	10
6251670	K 30 11		11	30	17.5	19	5.0	46	5
6251750	K 30 12		12	30	19.0	19	6.0	46	5
6251830	K 30 13		13	30	19.0	22	6.0	63	10
6251910	K 30 14		14	30	21.0	22	7.0	63	5
6252050	K 30 15		15	30	22.0	22	7.0	62	1
6252130	K 30 16		16	30	24.0	22	8.0	66	1
6252210	K 30 17		17	30	25.0	22	9.0	68	1
6252480	K 30 18		18	30	26.0	22	9.0	75	1
6252560	K 30 19		19	30	27.5	22	9.5	76	1
6252640	K 30 20	*	20	30	28.0	22	10.0	84	1
6252720	K 30 21	*	21	30	30.0	22	11.0	89	1
6252800	K 30 22	*	22	30	32.0	23	11.0	93	1
6252990	K 30 23	*	23	30	32.0	23	13.0	95	1
6254420	K 30 24	*	24	30	35.0	23	13.0	105	1

8608



273

TX K 30

IMPACT SOCKET 3/8" for protruding TORX® head screws

- ✔ Suitable for all standard electric and air tools
- ✔ Square drive as per DIN 3121 - G 10, ISO 1174
- ✔ GEDORE special steel, gun-metal finish
- ✔ TORX® is a registered trademark of Acument Intellectual Properties, LLC. USA

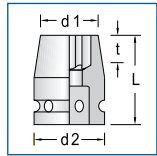

Code	No.	□"	□	■"	■	↳mm↳	↻	📦
6265030	TX K 30 E5	E5	M4	4.73	32	9.0	19	5 42 1
6265110	TX K 30 E6	E6	M5	5.74	32	10.0	19	5 44 1
6265380	TX K 30 E7	E7	M6	6.16	32	10.0	19	7 44 1
6265460	TX K 30 E8	E8	M6 - M7	7.52	32	10.5	19	8 48 1
6265540	TX K 30 E10	E10	M8	9.42	32	12.5	19	9 48 1
6265620	TX K 30 E12	E12	M10	11.17	32	15.0	19	10 47 1
6265700	TX K 30 E14	E14	M12	12.90	32	19.0	19	12 46 1

KB 3019

CONVERTOR 3/8" TO 1/2" for impact sockets

- ✔ With square drive as per DIN 3121 - G 10, ISO 1174
- ✔ GEDORE special steel, manganese-phosphated



Code	No.	□"	□	■"	■	↳mm↳	↻	📦
6263410	KB 3019	3/8	10	1/2	12.5	33	61	1

KB 3020

REDUCER 3/8" TO 1/4" for impact sockets

- ✔ With square drive as per DIN 3121 - G 10, ISO 1174
- ✔ GEDORE special steel, manganese-phosphated



Code	No.	□"	□	■"	■	↳mm↳	↻	📦
6263250	KB 3020	3/8	10	1/4	6.3	31	34	1

KB 3090

EXTENSION 3/8" for impact sockets

- ✔ With square drive as per DIN 3121 - G 10, ISO 1174
- ✔ GEDORE special steel, manganese-phosphated



Code	No.	■"	■	↳mm↳	↻	📦
6261710	KB 3090-3	3/8	10	75	90	1
6262010	KB 3090-5	3/8	10	125	149	1
6262280	KB 3090-10	3/8	10	250	298	1

KB 3095

UNIVERSAL JOINT 3/8" for impact sockets

- ✔ With square drive as per DIN 3121 - G 10, ISO 1174
- ✔ GEDORE special steel, manganese-phosphated



Code	No.	□"	□	■"	■	↳mm↳	↻	📦
6262440	KB 3095	3/8	10	3/8	10	50	72	1

KB 3070 - KB 3075

SAFETY RING AND SAFETY PIN for impact sockets 3/8"



Code	No.	Description	Use	∅	↳mm↳	↻	📦
6260820	KB 3070 6-12	Safety ring d 13 mm	for K 30 6-12 mm	14.0		2	1
6260900	KB 3070 13-24	Safety ring d 16 mm	for K 30 13-24 mm	15.5		2	1
6261040	KB 3075 6-12	Safety pin d 2.5 mm	for K 30 6-12 mm	2.5	14	5	1
6261120	KB 3075 13-24	Safety pin d 2.5 mm	for K 30 13-24 mm	2.5	16	2	1

12.5 MM (1/2") SQUARE DRIVE

K 19

IMPACT SOCKET 1/2" hexagon METRIC

- ✔ Acc. to DIN 3129, ISO 2725-2
- ✔ Suitable for all standard electric and air tools
- ✔ Square drive as per DIN 3121 - G 12.5, ISO 1174
- ✔ GEDORE special steel, gun-metal finish
- ✔ * not standardised

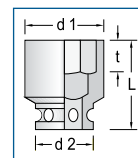
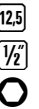

mm

Code	No.	*	∅mm	L	d ₁	d ₂	t	↻	📦
6160280	K 19 10		10	38	17.0	25	5.0	82	10
6160360	K 19 11		11	38	19.0	25	5.0	85	5
6160440	K 19 12		12	38	20.0	25	6.0	84	5
6160520	K 19 13		13	38	21.0	25	6.0	81	10
6160600	K 19 14		14	38	22.0	25	7.0	82	5
6161680	K 19 15		15	38	24.0	30	7.0	125	10
6160790	K 19 16		16	38	25.0	30	8.0	124	10
6160870	K 19 17		17	38	26.0	30	9.0	123	10
6160950	K 19 18		18	38	27.5	30	9.0	122	10
6161090	K 19 19		19	38	27.5	30	9.5	119	10
6161170	K 19 21		21	38	30.0	30	11.0	137	10
6161250	K 19 22		22	38	32.0	30	11.0	142	10
6161330	K 19 23	*	23	38	32.0	30	13.0	148	10
6161410	K 19 24		24	45	35.0	30	13.0	154	10
6182680	K 19 27		27	50	38.0	30	13.0	180	10
1560557	K 19 30	*	30	50	41.0	30	16.0	256	1
1783742	K 19 32	*	32	50	44.0	30	17.0	286	1



K 19



Code	No.	Ø AF	L	d ₁	d ₂	t	⚙️	📦
6166990	K 19 3/8AF	3/8	38	16.0	25	4.0	79	1
6162300	K 19 7/16AF	7/16	38	18.0	25	6.0	79	1
6162650	K 19 1/2AF	1/2	38	20.0	25	6.0	78	1
6163030	K 19 9/16AF	9/16	38	22.0	25	7.0	80	1
6163460	K 19 5/8AF	5/8	38	25.0	25	8.0	121	1
6163700	K 19 11/16AF	11/16	38	25.0	25	9.0	121	1
6163970	K 19 3/4AF	3/4	38	27.5	30	9.5	115	1
6168420	K 19 13/16AF	13/16	38	30.0	30	11.0	131	1
6169820	K 19 7/8AF	7/8	38	32.0	30	13.0	141	1
6164190	K 19 15/16AF	15/16	38	35.0	30	13.0	156	1
6169900	K 19 1AF	1	38	35.0	30	13.0	169	1
6164350	K 19 1.1/16AF	1.1/16	50	38.0	30	13.0	173	1
6164510	K 19 1.1/8AF	1.1/8	40	38.0	30	16.5	180	1
6165240	K 19 1.1/4AF	1.1/4	40	44.0	35	17.0	284	1
6165320	K 19 1.5/16AF	1.5/16	43	45.0	35	19.0	296	1



K 19 L

IMPACT SOCKET 1/2" hexagon, long pattern

- Suitable for all standard electric and air tools
- Square drive as per DIN 3121 - G 12.5, ISO 1174
- GEDORE special steel, manganese-phosphated

12.5

1/2"

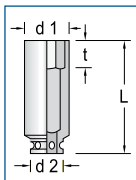

Code	No.	Ø mm	L	d ₁	d ₂	t	⚙️	📦
6163110	K 19 L 8	8	77	15.3	25	12	124	5
6163380	K 19 L 10	10	77	17.8	25	12	140	10
6163540	K 19 L 13	13	77	21.5	25	13	158	10
6163620	K 19 L 14	14	77	22.8	25	13	171	5
6197790	K 19 L 16	16	77	24.0	30	14	208	5
6163890	K 19 L 17	17	80	26.5	30	15	230	10
6197870	K 19 L 18	18	82	27.8	30	15	255	5
6164000	K 19 L 19	19	82	29.0	30	17	265	10
6162730	K 19 L 21	21	82	31.5	30	17	306	5
6164270	K 19 L 22	22	82	32.8	30	19	318	10
6199810	K 19 L 23	23	82	34.0	30	19	328	1
6164430	K 19 L 24	24	82	35.3	30	21	358	10
6164780	K 19 L 27	27	82	39.0	30	22	396	5

K 19 LD

IMPACT SOCKET 1/2" hexagon, long pattern, for cars

- Suitable for all standard electric and air tools
- Square drive as per DIN 3121 - G 12.5, ISO 1174
- For racing wheels, with a plastic insert to protect the wheel nuts
- Thin-walled to protect the alloy wheels
- GEDORE special steel, gun-metal finish

12.5

1/2"



Code	No.	Ø mm	L	d ₁	d ₂	t	⚙️	📦
6149120	K 19 LD 17	17	78	25	30	9.0	238	1
6149200	K 19 LD 19	19	78	27	30	9.5	274	1



1/2"

K 19 LS

IMPACT SOCKET 1/2" WITH PROTECTIVE SLEEVE hexagon, long pattern

- Square drive as per DIN 3121 - G 12.5, ISO 1174
- GEDORE special steel, manganese-phosphated

12.5

1/2"

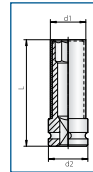

Code	No.	Ø mm	RAL	Colour	L	d ₁	d ₂	t	⚙️	📦
2178214	K 19 LS 17	17	5017	Traffic blue	81	27.0	30	15	200	1
2178222	K 19 LS 19	19	6024	Traffic green	83	29.0	30	17	210	1
2178230	K 19 LS 21	21	3020	Traffic red	83	30.5	30	17	230	1
2178249	K 19 LS 22	22	1023	Traffic yellow	83	32.3	30	19	260	1

KR 19

IMPACT SOCKET 1/2" hexagon, for cars

- Suitable for all standard electric and air tools
- Square drive as per DIN 3121 - G 12.5, ISO 1174
- GEDORE special steel, gun-metal finish

12.5

1/2"

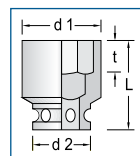

Code	No.	Ø mm	L	d ₁	d ₂	t	⚙️	📦
6162490	KR 19 17	17	45	30.0	30	11	174	1
6162570	KR 19 19	19	45	33.0	30	13	186	1

TX K 19

IMPACT SOCKET 1/2" for protruding TORX® head screws

- Suitable for all standard electric and air tools
- Square drive as per DIN 3121 - G 12.5, ISO 1174
- GEDORE special steel, gun-metal finish
- TORX® is a registered trademark of Acument Intellectual Properties, LLC. USA

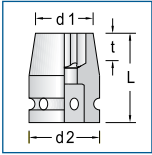

Code	No.	□"	□"	■"	■"	□"	□"	□"	□"
6223110	TX K 19 E10	E10	M8	9.42	38	15.0	25	9	84
6223380	TX K 19 E12	E12	M10	11.17	38	16.0	25	10	85
6223460	TX K 19 E14	E14	M12	12.90	38	18.5	25	12	86
6223540	TX K 19 E16	E16	M12	14.76	38	20.0	25	12	88
6223620	TX K 19 E18	E18	M14	16.70	38	22.0	25	12	87
6223700	TX K 19 E20	E20	M16	18.45	38	25.0	30	13	140
6223890	TX K 19 E24	E24	M18 - M20	22.16	45	28.5	30	17	137

IN K 19

IMPACT SCREWDRIVER BIT SOCKET 1/2" for in-hex screws

- Suitable for all standard electric and air tools
- Square drive as per DIN 3121 - G 12.5, ISO 1174
- GEDORE special steel, manganese-phosphated

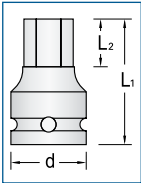

Code	No.	● mm	L ₁	L ₂	d	□"	□"
6223970	IN K 19 5	5	38	5.0	25	73	10
6224000	IN K 19 6	6	38	6.0	25	72	10
6224190	IN K 19 8	8	38	8.0	25	77	10
6224270	IN K 19 10	10	40	10.0	25	79	10
6224350	IN K 19 12	12	42	12.0	30	136	10
6225320	IN K 19 14	14	43	14.0	30	144	10
6225670	IN K 19 17	17	45	17.0	30	157	10

ITX K 19

IMPACT SCREWDRIVER BIT SOCKET 1/2" for recessed TORX® head screws

- Square drive as per DIN 3121 - G 12.5, ISO 1174
- GEDORE special steel, manganese-phosphated
- TORX® is a registered trademark of Acument Intellectual Properties, LLC. USA

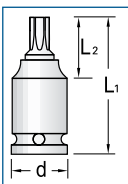
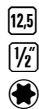

Code	No.	●	□"	■ mm	L ₁	L ₂	d	□"	□"
6197280	ITX K 19 T30	T30	M6 - M7	5.52	57	26	25	75	5
6197360	ITX K 19 T40	T40	M7 - M8	6.65	57	26	25	77	5
1603124	ITX K 19 T45	T45	M8 - M10	7.82	57	26	25	78	5
6197440	ITX K 19 T50	T50	M10	8.83	57	26	25	79	5
6197520	ITX K 19 T55	T55	M12	11.22	57	26	25	84	5
6197600	ITX K 19 T60	T60	M14	13.25	60	26	60	88	5

KB 1930

REDUCER 1/2" TO 3/8" for impact sockets

- With square drive as per DIN 3121 - G 12.5, Form F, G, and H
- GEDORE special steel, manganese-phosphated



Code	No.	□"	□"	■"	■"	□"	□"	□"
6650370	KB 1930	1/2	12.5	3/8	10	38	81	1

KB 1932

CONVERTOR 1/2" TO 3/4" for impact sockets

- With square drive as per DIN 3121 - G 12.5, Form F, G, and H
- GEDORE special steel, manganese-phosphated

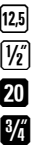

Code	No.	□"	□"	■"	■"	□"	□"	□"
6650020	KB 1932	1/2	12.5	3/4	20	48	146	1

KB 1990

EXTENSION 1/2" for impact sockets

- With square drive as per DIN 3121 - G 12.5, Form F, G, and H
- GEDORE special steel, manganese-phosphated



Code	No.	■"	■"	□"	□"	□"	□"
6655250	KB 1990-5	1/2	12.5	125	256	1	
6650100	KB 1990-10	1/2	12.5	250	461	1	

KB 1995

UNIVERSAL JOINT 1/2" for impact sockets

- With square drive as per DIN 3121 - G 12.5, Form F, G, and H
- GEDORE special steel, manganese-phosphated



Code	No.	■"	■"	□"	□"	□"	□"	□"
6655410	KB 1995	1/2	12.5	1/2	12.5	52	202	1



KB 1970 - KB 1975

SAFETY RING AND SAFETY PIN for impact sockets 1/2"

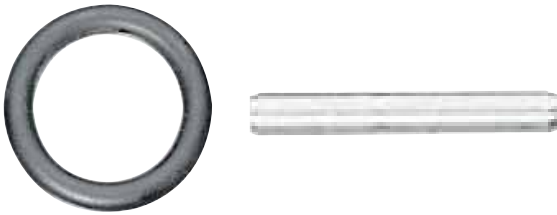

12.5
1/2

Code	No.	Description	Ø	l	d ₁	d ₂	t	↕	☰
6654790	KB 1970 10-14	Safety ring d 19 mm	19					2	10
6654870	KB 1970 15-27	Safety ring d 24 mm	24					2	10
6654950	KB 1975 10-14	Safety pin d 3 mm	3	20				2	10
6655090	KB 1975 15-27	Safety pin d 3 mm	3	25				2	10

K 19-028

IMPACT SOCKET SET 1/2" FOR CARS 5 pieces

- 5 sockets, suitable for all standard electric and air tools
- Square drive as per DIN 3121 - G 12.5, ISO 1174
- GEDORE special steel, gun-metal finish
- In black plastic case



12.5
1/2

Code	No.	Sockets	↕	☰
1646923	K 19-028	Ø 10 13 17 19 24	749	1

20 MM (3/4") SQUARE DRIVE

K 32

IMPACT SOCKET 3/4" hexagon METRIC

- Acc. to DIN 3129, ISO 2725-2
- Suitable for all standard electric and air tools
- Square drive as per DIN 3121 - H 20, ISO 1174
- GEDORE special steel, gun-metal finish
- * not standardised



20
3/4

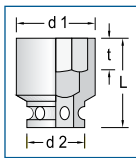

Code	No.	*	Ø mm	L	d ₁	d ₂	t	↕	☰
6282040	K 32 17		17	45	29	44	9.0	300	1
6289990	K 32 18		18	45	32	44	9.0	300	1
6282120	K 32 19		19	45	32	44	9.5	293	1
6282200	K 32 22		22	46	38	44	11.0	345	1
6282390	K 32 24		24	46	40	44	13.0	339	1
6282470	K 32 27		27	48	41	44	13.0	339	1
6282550	K 32 30		30	52	44	44	16.5	352	1
6282630	K 32 32		32	52	49	44	17.0	407	1
6283010	K 32 33 (3/4W) *		33	55	49	44	17.0	430	1
6281580	K 32 34		34	55	52	44	19.0	475	1
6282710	K 32 36		36	56	52	44	19.0	444	1
6281740	K 32 38 *		38	59	54	44	22.0	481	1
6282980	K 32 41		41	59	57	44	22.0	500	1

K 32 L

IMPACT SOCKET 3/4" hexagon, long pattern

- Suitable for all standard electric and air tools
- Square drive as per DIN 3121 - H 20, ISO 1174
- GEDORE special steel, gun-metal finish



20
3/4

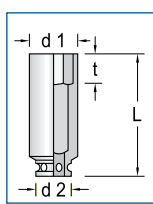

Code	No.	Ø mm	L	d ₁	d ₂	t	↕	☰
6283600	K 32 L 17	17	90	29	44	9.0	727	1
6283790	K 32 L 19	19	90	32	44	9.5	720	1
6286700	K 32 L 21	21	90	35	44	11.0	757	1
6283870	K 32 L 22	22	90	38	44	11.0	739	1
6283950	K 32 L 24	24	90	40	44	13.0	706	1
6284090	K 32 L 27	27	90	41	44	13.0	655	1
6284170	K 32 L 30	30	90	44	44	16.5	644	1
6284250	K 32 L 32	32	90	49	44	17.0	728	1
6286540	K 32 L 33 (3/4W)	33	90	49	44	17.0	709	1
6281660	K 32 L 34	34	90	52	44	19.0	858	1
6284330	K 32 L 36	36	90	52	44	19.0	826	1
6286890	K 32 L 41	41	90	57	44	22.0	811	1

mm

AF

Code	No.	Ø AF	L	d ₁	d ₂	t	↕	☰
6285300	K 32 13/16AF	13/16	46	35	44	11.0	349	1
6284410	K 32 7/8AF	7/8	46	38	44	13.0	354	1
6284680	K 32 15/16AF	15/16	46	40	44	13.0	342	1
6285490	K 32 1AF	1	46	41	44	13.0	340	1
6285650	K 32 1.1/16AF	1.1/16	48	41	44	13.0	347	1
6284760	K 32 1.1/8AF	1.1/8	52	44	44	16.5	367	1
6284840	K 32 1.1/4AF	1.1/4	52	49	44	17.0	418	1
6284920	K 32 1.5/16AF	1.5/16	55	49	44	19.0	417	1
6285730	K 32 1.3/8AF	1.3/8	55	52	44	19.0	452	1
6285060	K 32 1.7/16AF	1.7/16	56	52	44	19.0	439	1
6285140	K 32 1.1/2AF	1.1/2	59	54	44	22.0	480	1
6285810	K 32 1.5/8AF	1.5/8	59	57	44	22.0	497	1
6286030	K 32 1.11/16AF	1.11/16	64	63	44	25.0	674	1
6286110	K 32 1.3/4AF	1.3/4	64	63	44	25.5	639	1
6286380	K 32 1.7/8AF	1.7/8	67	67	54	27.0	873	1
6286460	K 32 2AF	2	67	73	54	27.0	995	1



Deviant packing units see article description.

IN K 32

IMPACT SCREWDRIVER BIT SOCKET 3/4" for in-hex screws

- ✔ Suitable for all standard electric and air tools
- ✔ Square drive as per DIN 3121 - H 20, ISO 1174
- ✔ GEDORE special steel, manganese-phosphated

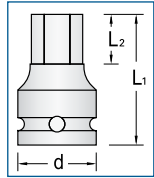

Code	No.	● mm	L ₁	L ₂	d	↕	☒
1956477	IN K 32 14	14	59	14	38	440	1
1956485	IN K 32 17	17	62	17	38	495	1
1956493	IN K 32 19	19	64	19	44	530	1
1956507	IN K 32 22	22	67	22	44	590	1
1956515	IN K 32 24	24	67	24	44	630	1
1956523	IN K 32 27	27	67	27	44	695	1

KB 3219

REDUCER 3/4" TO 1/2" for impact sockets

- ✔ With square drive as per DIN 3121, ISO 1174, Form F and H
- ✔ GEDORE special steel, manganese-phosphated

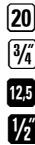

Code	No.	□"	□	■"	■	↳ mm	↕	☒
6675280	KB 3219	3/4	20	1/2	12.5	55	351	1

KB 3221

CONVERTOR 3/4" TO 1" for impact sockets

- ✔ With square drive as per DIN 3121, ISO 1174, Form F and H
- ✔ GEDORE special steel, manganese-phosphated

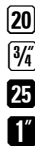

Code	No.	□"	□	■"	■	↳ mm	↕	☒
6671530	KB 3221	3/4	20	1	25	59	445	1

i Securing with pin and ring



KB 3290

EXTENSION 3/4" for impact sockets

- ✔ With square drive as per DIN 3121, ISO 1174, Form F and H
- ✔ GEDORE special steel, manganese-phosphated



Code	No.	■"	■	↳ mm	↕	☒
6675600	KB 3290-8	3/4	20	200	957	1
6675790	KB 3290-12	3/4	20	300	1328	1
6675870	KB 3290-16	3/4	20	400	1759	1

KB 3295

UNIVERSAL JOINT 3/4" for impact sockets

- ✔ With square drive as per DIN 3121, ISO 1174, Form F and H
- ✔ GEDORE special steel, manganese-phosphated



Code	No.	■"	■	□"	□	↳ mm	↕	☒
6676090	KB 3295	3/4	20	3/4	20	94	623	1

KB 3270 - KB 3275

SAFETY RING AND SAFETY PIN for impact sockets 3/4"



Code	No.	Description	∅	↳ mm	↕	☒
6675360	KB 3270	Safety ring d 36 mm	36	4	4	1
6675440	KB 3275	Safety pin d 4 mm	4	35	4	1

K 32-040

IMPACT SOCKET SET 3/4" FOR TRUCKS 4 pieces

- ✔ 4 sockets, suitable for all standard electric and air tools
- ✔ Square drive as per DIN 3121 - H 20, ISO 1174
- ✔ GEDORE special steel, gun-metal finish
- ✔ In black plastic case



Code	No.	Sockets	↕	☒
1828142	K 32-040	○ 24 27 30 33	1630	1

25 MM (1") SQUARE DRIVE

K 21

IMPACT SOCKET 1" hexagon METRIC

- Acc. to DIN 3129, ISO 2725-2
- Suitable for all standard electric and air tools
- Square drive as per DIN 3121 - H 25, ISO 1174
- GEDORE special steel, gun-metal finish
- Use KB 3770 and KB 3775 from 75 mm and up
- * not standardised

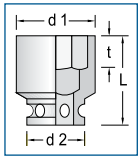

mm

Code	No.	*	Ø mm	L	d ₁	d ₂	t	↕	☒
6183060	K 21 22		22	55	40.0	54	11.0	561	1
6183140	K 21 24		24	55	42.0	54	13.0	611	1
6183220	K 21 27		27	55	46.0	54	13.0	614	1
6183300	K 21 30		30	57	50.0	54	16.5	619	1
6183490	K 21 32		32	57	51.0	54	17.0	608	1
6183650	K 21 33	*	33	57	54.0	54	17.0	615	1
6196980	K 21 34		34	60	54.0	54	19.0	624	1
6183570	K 21 36		36	60	54.0	54	19.0	598	1
6184890	K 21 38	*	38	64	60.0	54	19.0	764	1
6183730	K 21 41		41	64	63.0	54	22.0	794	1
6184970	K 21 42	*	42	64	63.0	54	22.0	781	1
6183810	K 21 46		46	69	70.0	54	25.5	974	1
6184030	K 21 50		50	72	73.0	54	27.0	1018	1
6184110	K 21 55		55	76	82.0	54	30.0	1298	1
6184380	K 21 60		60	82	86.0	54	33.0	1481	1
6184460	K 21 65		65	85	92.0	54	35.0	1682	1
6184540	K 21 70		70	88	96.0	54	38.0	1812	1
6184620	K 21 75	*	75	92	100.0	86	41.0	2690	1
6184700	K 21 80	*	80	97	105.0	86	44.0	2936	1

"AF"

Code	No.	Ø "AF"	L	d ₁	d ₂	t	↕	☒
6186320	K 21 1AF	1	55	43	54	13.0	611	1
6186400	K 21 1.1/4AF	1.1/4	57	51	54	17.0	614	1
6186590	K 21 1.7/16AF	1.7/16	60	54	54	19.0	593	1
6186750	K 21 1.1/2AF	1.1/2	64	60	54	22.0	776	1
6186670	K 21 1.5/8AF	1.5/8	64	63	54	22.0	796	1
6186830	K 21 1.13/16AF	1.13/16	69	70	54	25.5	972	1
6186910	K 21 1.7/8AF	1.7/8	72	70	54	27.0	981	1
6187050	K 21 2.1/4AF	2.1/4	80	82	54	33.0	1365	1



Deviant packing units see article description.

K 21 L

IMPACT SOCKET 1" hexagon, long pattern

- Suitable for all standard electric and air tools
- Square drive as per DIN 3121 - H 25, ISO 1174
- GEDORE special steel, gun-metal finish

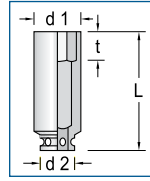

Code	No.	Ø mm	L	d ₁	d ₂	t	↕	☒
6185350	K 21 L 22	22	100	40	54	11.0	1103	1
6185430	K 21 L 24	24	100	42	54	13.0	1234	1
6185510	K 21 L 27	27	100	46	54	13.0	1227	1
6185780	K 21 L 30	30	100	50	54	16.5	1141	1
6185860	K 21 L 32	32	100	51	54	17.0	1101	1
6197950	K 21 L 33	33	100	54	54	17.0	1104	1
6197010	K 21 L 34	34	100	54	54	19.0	1189	1
6185940	K 21 L 36	36	100	54	54	19.0	1022	1
6186080	K 21 L 38	38	100	60	54	22.0	1262	1
6186160	K 21 L 41	41	100	63	54	22.0	1420	1
6186240	K 21 L 46	46	100	70	54	25.5	1619	1

IN K 21

IMPACT SCREWDRIVER BIT SOCKET 1" for in-hex screws

- Suitable for all standard electric and air tools
- Square drive as per DIN 3121 - H 25, ISO 1174
- GEDORE special steel, manganese-phosphated

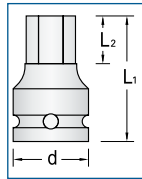

Code	No.	Ø mm	L ₁	L ₂	d	↕	☒
1956558	IN K 21 19	19	71	19	54	825	1
1956566	IN K 21 22	22	75	22	54	885	1
1956574	IN K 21 24	24	75	24	54	920	1
1956582	IN K 21 27	27	82	27	54	980	1
1956590	IN K 21 32	32	82	32	54	1125	1
1956604	IN K 21 36	36	82	36	54	1245	1

KB 2132

REDUCER 1" TO 3/4" for impact sockets

- Square drive as per DIN 3121, ISO 1174, Form F and H
- GEDORE special steel, manganese-phosphated
- Use KB 3770 and KB 3775 for 75 and 80 mm



Code	No.	□"	□	■"	■	↳ mm	↕	☒
6657460	KB 2132	1	25	3/4	20	77	661	1

KB 2137

CONVERTOR 1" TO 1.1/2" for impact sockets

- Square drive as per DIN 3121, ISO 1174, Form F and H
- GEDORE special steel, manganese-phosphated
- Use KB 3770 and KB 3775 for 75 and 80 mm



Code	No.	□"	□	■"	■	↳ mm	↕	☒
6657890	KB 2137	1	25	1.1/2	40	85	988	1

KB 2190

EXTENSION 1" for impact sockets

- ▶ Square drive as per DIN 3121, ISO 1174, Form F and H
- ▶ GEDORE special steel, manganese-phosphated
- ▶ Use KB 3770 and KB 3775 for 75 and 80 mm

25
1"



Code	No.	■"	■	(-mm-)	↻	📦
6657970	KB 2190-8	1	25	200	1477	1
6658000	KB 2190-12	1	25	300	2010	1
6658190	KB 2190-16	1	25	400	2587	1

KB 2195

UNIVERSAL JOINT 1" for impact sockets

- ▶ Square drive as per DIN 3121, ISO 1174, Form F and H
- ▶ GEDORE special steel, manganese-phosphated
- ▶ Use KB 3770 and KB 3775 for 75 and 80 mm

25
1"



Code	No.	■"	■	□"	□	(-mm-)	↻	📦
6658350	KB 2195	1	25	1	25	136.5	1425	1

KB 2170 - KB 2175

SAFETY RING AND SAFETY PIN for impact sockets 1"

25
1"



Code	No.	Description	∅	(-mm-)	↻	📦
6657620	KB 2170	Safety ring d 45 mm	45		8	10
6657700	KB 2175	Safety pin d 5 mm	5	45	7	10

40 MM (1.1/2") SQUARE DRIVE

K 37

IMPACT SOCKET 1.1/2" hexagon

- ▶ Acc. to DIN 3129, ISO 2725-2
- ▶ Suitable for all standard electric and air tools
- ▶ Square drive as per DIN 3121 - H 40, ISO 1174
- ▶ GEDORE special steel, gun-metal finish
- ▶ Use KB 6470 and KB 6475 from 95 mm and up
- ▶ * not standardised

40
1 1/2"

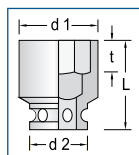

Code	No.	*	∅mm	L	d ₁	d ₂	t	↻	📦
6328130	K 37 46		46	80	75	86	25.5	2265	1
6328210	K 37 50	*	50	82	80	86	27.0	2306	1
6328480	K 37 55		55	89	86	86	30.0	2459	1
6328560	K 37 60		60	92	92	86	33.0	2744	1
6328640	K 37 65		65	96	100	86	35.0	3215	1
6328720	K 37 70		70	101	105	86	38.0	3535	1
6328800	K 37 75		75	105	109	86	41.0	3735	1
6328990	K 37 80		80	110	115	86	44.0	4185	1

Code	No.	*	∅mm	L	d ₁	d ₂	t	↻	📦
6329020	K 37 85		85	116	121	86	47.0	4795	1
6329100	K 37 90		90	118	130	86	49.0	5460	1
6329290	K 37 95	*	95	118	135	127	49.0	9000	1
6329370	K 37 100	*	100	125	140	127	54.0	8095	1
6329450	K 37 105	*	105	125	150	127	54.0	9270	1
6329530	K 37 110	*	110	137	155	127	62.0	10625	1
6329610	K 37 115	*	115	137	160	127	67.0	10575	1
6329880	K 37 120	*	120	145	165	127	67.0	11770	1

K 37 L

IMPACT SOCKET 1.1/2" hexagon, long pattern

- ▶ Suitable for all standard electric and air tools
- ▶ Square drive as per DIN 3121 - H 40, ISO 1174
- ▶ GEDORE special steel, gun-metal finish
- ▶ Use KB 6470 and KB 6475 from 95 mm and up

40
1 1/2"

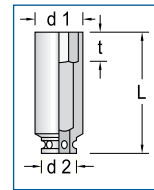

Code	No.	∅mm	L	d ₁	d ₂	t	↻	📦
6330110	K 37 L 41	41	140	70	86	22.0	4400	1
6330380	K 37 L 46	46	140	75	86	25.5	4330	1
6330460	K 37 L 50	50	140	80	86	27.0	4365	1
6330540	K 37 L 55	55	140	86	86	30.0	3950	1
6330620	K 37 L 60	60	140	92	86	33.0	4135	1
6330700	K 37 L 65	65	140	100	86	35.0	4620	1
6330890	K 37 L 70	70	140	105	86	38.0	4805	1
6330970	K 37 L 75	75	140	109	86	41.0	5395	1
6331000	K 37 L 80	80	140	115	86	44.0	5660	1
6331190	K 37 L 85	85	140	121	86	47.0	6154	1
6331270	K 37 L 90	90	140	130	86	49.0	6595	1
6331350	K 37 L 95	95	150	135	127	49.0	9960	1
6331430	K 37 L 100	100	150	140	127	54.0	9964	1
6331510	K 37 L 105	105	150	150	127	54.0	11314	1
6331780	K 37 L 110	110	160	155	127	62.0	12800	1
6331860	K 37 L 115	115	160	160	127	67.0	12225	1
6331940	K 37 L 120	120	170	165	127	67.0	13845	1

KB 3721

REDUCER 1.1/2" TO 1" for impact sockets

- ▶ Square drive as per DIN 3121, ISO 1174, Form F and H
- ▶ Use KB 3770 and KB 3775 up to 90 mm
- ▶ Use KB 6470 and KB 6475 from 95 mm and up
- ▶ GEDORE special steel, gun-metal finish

40
1 1/2"
25
1"



Code	No.	□"	□	■"	■	(-mm-)	↻	📦
6676410	KB 3721	1.1/2	40	1	25	95	1992	1

Securing with pin and ring



KB 3764

CONVERTOR 1.1/2" TO 2.1/2" for impact sockets (not illustrated)

- Square drive as per DIN 3121, ISO 1174, Form F and H
- Use KB 3770 and KB 3775 up to 90 mm
- Use KB 6470 and KB 6475 from 95 mm and up
- GEDORE special steel, gun-metal finish



40
1 1/2
63
2 1/2

Code	No.	□"	□	■"	■	∅	↳mm↳	↻	📦
1531220	KB 3764	1.1/2	40	63	2	86	93	3600	1

KB 3770 - KB 3775

SAFETY RING AND SAFETY PIN for impact sockets 1.1/2"

- Use KB 3770 and KB 3775 up to 90 mm
- Use KB 6470 and KB 6475 from 95 mm and up

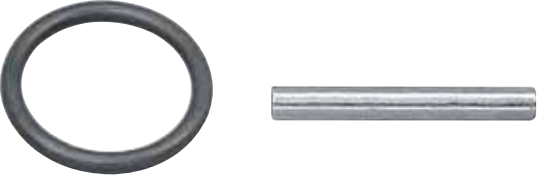

40
1 1/2

Code	No.	Description	∅	↳mm↳	↻	📦
6676760	KB 3770	Safety ring d 75 mm	75	26	1	
6676840	KB 3775	Safety pin d 6 mm	6	75	17	1

63 MM (2.1/2") SQUARE DRIVE

K 64

IMPACT SOCKET 2.1/2" hexagon

- Acc. to DIN 3129, ISO 2725-2
- Suitable for all standard electric and air tools
- Square drive as per DIN 3121 - H 63, ISO 1174
- GEDORE special steel, gun-metal finish
- * not standardised

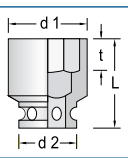
63
2 1/2

Code	No.	*	∅mm	L	d ₁	d ₂	t	↻	📦
6371300	K 64 75		75	125	115	127	41	7350	1
6371490	K 64 80		80	125	115	127	44	7015	1
6371570	K 64 85		85	130	127	127	47	7295	1
6371650	K 64 90		90	132	135	127	49	7955	1
6371730	K 64 95		95	132	140	127	49	8120	1
6371810	K 64 100		100	141	145	127	54	8905	1
6372030	K 64 105		105	141	150	127	54	9145	1
6372110	K 64 110		110	150	160	127	62	11000	1
6372380	K 64 115		115	150	165	127	62	11130	1
6372460	K 64 120	*	120	158	170	127	67	12030	1

KB 6437

REDUCER 2.1/2" TO 1.1/2" for impact sockets

- Square drive as per DIN 3121, ISO 1174, Form F and H
- Use KB 3770 and KB 3775 up to 90 mm
- Use KB 6470 and KB 6475 from 95 mm and up
- GEDORE special steel, gun-metal finish



63
2 1/2
40
1 1/2

Code	No.	□"	□	■"	■	↳mm↳	↻	📦
6699700	KB 6437	2.1/2	63	1.1/2	40	138	7090	1

KB 6470 - KB 6475

SAFETY RING AND SAFETY PIN for impact sockets 2.1/2"

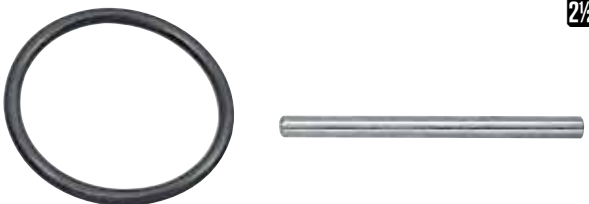

63
2 1/2

Code	No.	Description	∅	↳mm↳	↻	📦
6699890	KB 6470	Safety ring d 114 mm	114	40	1	
6699970	KB 6475	Safety pin d 8 mm	8	110	43	1

IMPACT DRIVER

K 1900

HAND-OPERATED IMPACT DRIVER 1/2"

- Particularly suitable for loosening tight bolts or screws with the aid of a hammer
- Reversible for right and left hand operation
- Will fit any 1/2" impact socket or bit
- Manganese-phosphated

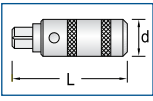
12.5
1 1/2

Code	No.	■"	■	L	∅-d	↻	📦
6654440	K 1900	1/2	12.5	123	34	579	1

K 1900-013

HAND-OPERATED IMPACT DRIVER SET 1/2"

- Complete with the most frequently used bits, for use on screws and bolts with slotted, cross-slotted or hexagon heads
- Reversible for right and left hand operation
- In GEDORIT blue sheet steel case with black plastic insert, dimensions: 281 x 79 x 42 mm



12.5
1 1/2
8
5/16
1/8
1/16
+

Code	No.	Contents	↻	📦
6654600	K 1900-013	⊖ 880 7 8 9 12 ⊕ 885 5 6 8 10 ⊕ 890 2 3 4L KB 819 K 1900	1249	1

1500 ES-K 1900



88

BIT RANGE

4 MM HEXAGON SQUARE DRIVE

- For precision work on small components (e.g. clocks, electronics, model making...)
- Mirror-polished for improved corrosion protection
- Vanadium Plus material for safe, reliable application of force to the small effective zones of the miniature screws



480 - 490

MINIBITS

For TORX® = reg. trademark of Acument Intellectual Properties, LLC. USA



Code	No.	for	↳mm↳	📦
1801465	480 0,8	⊖	20	1
1801473	480 1,2	⊖	20	1
1801481	480 1,5	⊖	20	1
1801503	480 1,8	⊖	20	1
1801511	480 2	⊖	20	1
1801538	480 2,5	⊖	20	1
1801546	480 3	⊖	20	1
1801554	485 0,7	●	20	1
1801562	485 0,9	●	20	1
1801570	485 1,3	●	20	1
1801589	485 1,5	●	20	1
1801597	485 2	●	20	1
1801600	485 2,5	●	20	1
1801619	485 3	●	20	1
1801627	485 B 2	⊙	20	1
1801635	485 B 2,5	⊙	20	1
1801643	485 B 3	⊙	20	1
1801805	490 PH 000	⊕	20	1
1801813	490 PH 00	⊕	20	1
1801821	490 PH 0	⊕	20	1
1801848	490 PZD 000	⊕	20	1
1801856	490 PZD 00	⊕	20	1
1801864	490 PZD 0	⊕	20	1
1801651	487 TX T3	⊗	20	1
1801678	487 TX T4	⊗	20	1
1801686	487 TX T5	⊗	20	1
1801694	487 TX T6	⊗	20	1
1801708	487 TX T7	⊗	20	1
1801716	487 TX T8	⊗	20	1
1801724	487 TX T9	⊗	20	1
1801732	487 TX T10	⊗	20	1
1801740	487 TX T15	⊗	20	1
1801759	488 TX T7	⊗	20	1
1801767	488 TX T8	⊗	20	1
1801775	488 TX T9	⊗	20	1
1801783	488 TX T10	⊗	20	1
1801791	488 TX T15	⊗	20	1

499

BIT EXTENSION

- With magnetic holder



Code	No.	●	○	Description	↳mm↳	📦
1801414	499	4	4	Bit extension 4 mm hex	58 10	1
1801422	499 F	4	4	Bit extension flexible 4 mm hex	114 23	1

471

BIT RATCHET

- Super slim pattern
- 1/4" recess - or 4 mm recess when used in conjunction with no. 420
- GEDORE vanadium special steel, chrome-plated



Code	No.	○	↳mm↳	mm ² _{cup}	📦
1801341	471	4	90	9,5	23 1

470

BIT SCREWDRIVER

- 2-component handle
- Fast turning zone and fast turning cap
- With magnetic holder



Code	No.	○	↳mm↳	📦
1801368	470	4	142 24	1

420

BIT ADAPTOR

- For bit ratchet no. 471
- With magnetic holder



Code	No.	○	●	●*	↳mm↳	📦
1801457	420	4	6.3	1/4	12 2	1



635

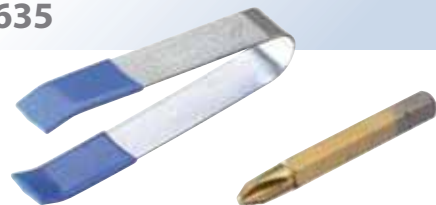

225



4

471-044

MINIBIT-SET 44 pieces

- ▶ In plastic case
- ▶ Dimensions: 160 x 95 x 38 mm
- ▶ TORX® = reg. trademark of Acument Intellectual Properties, LLC. USA



4

471-023

MINIBIT SET 23 pieces

- ▶ For electronics engineers, mechanics, model makers, etc.
- ▶ With 1/4" reversible ratchet and 1/4" to 4 mm bit adaptor, for use with 4 mm minibits
- ▶ In plastic case
- ▶ Dimensions: 110 x 65 x 31 mm
- ▶ TORX® = reg. trademark of Acument Intellectual Properties, LLC. USA



471-042

MINIBIT SET 42 pieces

- ▶ For electronics engineers, mechanics, model makers, etc.
- ▶ With 1/4" reversible ratchet and 1/4" to 4 mm bit adaptor, for use with 4 mm minibits
- ▶ In plastic case
- ▶ Dimensions: 160 x 95 x 38 mm
- ▶ TORX® = reg. trademark of Acument Intellectual Properties, LLC. USA



Code	No.	Ratchet	Sockets	Accessories	↔	📦
1801325	471-023	471	⊖ 480 0,8 1,2 1,5 1,8 ● 485 0,7 0,9 1,3 1,5 ⊕ 490 PH 000 00 0 ⊕ 490 PZD 000 00 0 ⊗ 487 TX T3 T4 T5 T6 T7 T8	420 499	125	1

➔ D 20 FMU-20





161

Code	No.	Ratchet	Sockets	Accessories	↔	📦
1801333	471-042	471	⊖ 480 0,8 1,2 1,5 1,8 2 2,5 3 ● 485 0,7 0,9 1,3 1,5 2 2,5 3 ● 485 B 2 2,5 3 ⊕ 490 PH 000 00 0 ⊕ 490 PZD 000 00 0 ⊗ 487 TX T3 T4 T5 T6 T7 T8 T9 T10 T15 ⊗ 488 TX T7 T8 T9 T10 T15	420 470 499 499 F	275	1

6.3 MM (1/4") HEXAGON DRIVE

SCREWDRIVER BITS 6.3 MM (1/4")



= Sales unit 10 / 5 pieces each



680

SCREWDRIVER BIT for slotted head screws

- For hand operation and use in electric and air tools
- Acc. to DIN ISO 2351-1
- Hexagon drive as per DIN 3126 - C 6.3 (1/4")
- GEDORE special vanadium steel, gun-metal finish
- Sales unit 10 / 5 pieces each**

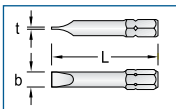

Code	No.	b	t	L		
6537640	680 4	4.0	0.5	25	5	10
6537720	680 4,5	4.5	0.6	25	5	10
6537800	680 5,5	5.5	0.8	25	6	10
6537990	680 6,5	6.5	1.2	25	6	10
6538020	680 7	7.0	1.2	25	6	10
6538100	680 8	8.0	1.6	25	7	10
6538290	680 10	10.0	1.6	39	16	5

685

SCREWDRIVER BIT for in-hex screws

- For hand operation and use in electric and air tools
- Acc. to DIN ISO 2351-3
- Hexagon drive as per DIN 3126 - C 6.3 (1/4")
- GEDORE special vanadium steel, gun-metal finish
- Sales unit 10 / 5 pieces each**

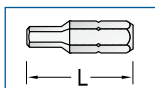

Code	No.	mm	ISO 4762	DIN 7984	L		
1802399	685 2	2.0	M2	M2	25	5	10
6538880	685 2,5	2.5	M3	M4	25	5	10
6538960	685 3	3.0	M4	M5	25	5	10
6539180	685 4	4.0	M5	M6	25	6	10
6539260	685 5	5.0	M6	M8	25	6	10
6539340	685 6	6.0	M8	M10	25	7	10
6539420	685 8	8.0	M10	M12	33	9	10
6539500	685 10	10.0	M12	M14	33	12	5

685 K

SCREWDRIVER BIT for in-hex screws, with ball end

- For hand operation and use in electric and air tools
- Hexagon drive as per DIN 3126 - C 6.3 (1/4")
- GEDORE special vanadium steel, gun-metal finish
- Sales unit 5 pieces each**

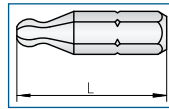

Code	No.	mm	ISO 4762	DIN 7984	L		
2225700	685 K 4	4	M5	M6	25	6	5
2225719	685 K 5	5	M6	M8	25	7	5
2225727	685 K 6	6	M8	M10	25	8	5
2225735	685 K 8	8	M10	M12	33	11	5
2225743	685 K 10	10	M12	M14	33	14	5

690

SCREWDRIVER BIT for cross-slotted head screws PH

- For hand operation and use in electric and air tools
- Acc. to DIN ISO 2351-2, tip as per DIN ISO 8764-1 PH
- Hexagon drive as per DIN 3126 - C 6.3 (1/4")
- GEDORE special vanadium steel, gun-metal finish
- Sales unit 10 pieces each**

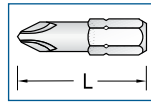

Code	No.	PH	L		
1803514	690 0	0	25	5	10
6541240	690 1	1	25	5	10
1828150	690 1 L	1	50	12	10
6541320	690 2	2	25	6	10
6541400	690 2 L	2	50	12	10
6541590	690 3	3	25	6	10
6541670	690 3 L	3	50	12	10
6541750	690 4	4	32	10	10

690 PZD

SCREWDRIVER BIT for cross-slotted head screws PZ

- For hand operation and use in electric and air tools
- Acc. to DIN ISO 2351-2, tip as per DIN ISO 8764-1 PZ
- Hexagon drive as per DIN 3126 - C 6.3 (1/4")
- GEDORE special vanadium steel, gun-metal finish
- Sales unit 10 pieces each**

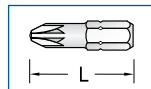

Code	No.	PZ	L		
6552790	690 PZD 1	1	25	5	10
1827022	690 PZD 1 L	1	50	12	10
6552870	690 PZD 2	2	25	6	10
6552950	690 PZD 2 L	2	50	12	10
6553090	690 PZD 3	3	25	6	10
6553170	690 PZD 3 L	3	50	12	10
6553680	690 PZD 4	4	32	15	10



1500 ES/CT-20 BIT



91





686

SCREWDRIVER BIT for multi-spline screws RIBE®

- For hand operation and use in electric and air tools
- Hexagon drive as per DIN 3126 - C 6.3 (1/4")
- GEDORE special vanadium steel, gun-metal finish
- RIBE® = reg. trademark of Richard Bergner GmbH & Co. KG, Schwabach, Germany
- Sales unit 10 pieces each

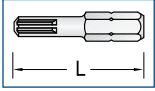

Code	No.	ISO 4762	L	ISO 7984	PK
6540510	686 4	M4	33	6	10
6540780	686 5	M5	33	7	10
6540860	686 6	M6	33	8	10
6540940	686 8	M8	33	11	10

685 X

SCREWDRIVER BIT for multi-point screws XZIN

- For hand operation and use in electric and air tools
- Acc. to DIN ISO 65254
- Hexagon drive as per DIN 3126 - C 6.3 (1/4"), tip as per DIN 2325
- GEDORE special vanadium steel, gun-metal finish
- Sales unit 10 pieces each

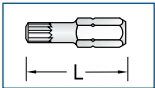

Code	No.	ISO 4762	L	ISO 7984	PK
6540000	685 X 5	M5	25	6	10
6540190	685 X 6	M6	25	6	10
6540270	685 X 8	M8	25	8	10

687 TX

SCREWDRIVER BIT for recessed TORX® head screws

- For hand operation and use in electric and air tools
- Hexagon drive as per DIN 3126 - C 6.3 (1/4")
- GEDORE special vanadium steel, gun-metal finish
- TORX® is a registered trademark of Acument Intellectual Properties, LLC. USA
- Sales unit 10 pieces each

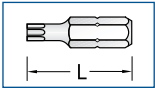

Code	No.	ISO 4762	mm	L	ISO 7984	PK	
6541830	687 TX T6	T6	M2	1.70	25	5	10
6541910	687 TX T7	T7	M2,5	1.99	25	5	10
6542050	687 TX T8	T8	M2,5	2.31	25	5	10
6542130	687 TX T9	T9	M3	2.50	25	5	10
6542210	687 TX T10	T10	M3 - M3,5	2.74	25	5	10
6542480	687 TX T15	T15	M3,5 - M4	3.27	25	5	10
6542560	687 TX T20	T20	M4 - M5	3.86	25	5	10
6542640	687 TX T25	T25	M4,5 - M5	4.43	25	6	10
6542720	687 TX T27	T27	M4,5 - M6	4.99	25	6	10
6542800	687 TX T30	T30	M6 - M7	5.52	25	6	10
6542990	687 TX T40	T40	M7 - M8	6.65	25	7	10

688 TX

SCREWDRIVER BIT for recessed TORX® head screws with pilot

- For hand operation and use in electric and air tools
- Hexagon drive as per DIN 3126 - C 6.3 (1/4")
- GEDORE special vanadium steel, gun-metal finish
- TORX® is a registered trademark of Acument Intellectual Properties, LLC. USA
- Sales unit 10 pieces each

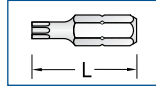

Code	No.	ISO 4762	ISO 4762	mm	L	ISO 7984	PK
6535510	688 TX T10	T10	M3 - M3,5	2.74	25	5	10
6535780	688 TX T15	T15	M3,5 - M4	3.27	25	5	10
6535860	688 TX T20	T20	M4 - M5	3.86	25	5	10
6535940	688 TX T25	T25	M4,5 - M5	4.43	25	6	10
6536080	688 TX T27	T27	M4,5 - M6	4.99	25	6	10
6536160	688 TX T30	T30	M6 - M7	5.52	25	6	10
6536240	688 TX T40	T40	M7 - M8	6.65	25	6	10

TIN SCREWDRIVER BITS 6.3 MM (1/4")

- Made from high-quality materials with high-strength, double titanium nitride surface coating
- High degree of wear resistance, preventing damage to screw heads and ensuring long life of the bit
- PK = Sales unit 5 pieces each

TIN 680

SCREWDRIVER BIT for slotted head screws

- For hand operation and use in electric and air tools
- Acc. to DIN ISO 2351-1
- Hexagon drive as per DIN 3126 - C 6.3 (1/4")
- GEDORE special steel, titanium-nitrided
- Sales unit 5 pieces each

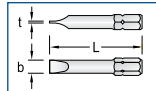

Code	No.	b	t	L	ISO 7984	PK
1828320	TIN 680 4	4.0	0.5	25	5	5
1828339	TIN 680 5,5	5.5	0.8	25	6	5
1828347	TIN 680 6,5	6.5	1.2	25	6	5
1828355	TIN 680 8	8.0	1.6	25	7	5

TIN 685

SCREWDRIVER BIT for in-hex screws

- For hand operation and use in electric and air tools
- Acc. to DIN ISO 2351-3
- Hexagon drive as per DIN 3126 - C 6.3 (1/4")
- GEDORE special steel, titanium-nitrided
- Sales unit 5 pieces each

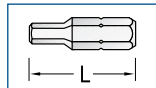

Code	No.	mm	ISO 4762	DIN 7984	L	ISO 7984	PK
1828363	TIN 685 2	2.0	M2	M2	25	5	5
1828371	TIN 685 2,5	2.5	M3	M4	25	5	5
1828398	TIN 685 3	3.0	M4	M5	25	5	5
1828401	TIN 685 4	4.0	M5	M6	25	6	5
1828428	TIN 685 5	5.0	M6	M8	25	6	5
1828436	TIN 685 6	6.0	M8	M10	25	7	5
1828444	TIN 685 8	8.0	M10	M12	33	9	5
1828452	TIN 685 10	10.0	M12	M14	33	12	5

20 XLU-3 T



160

TIN 690

SCREWDRIVER BIT for cross-head screws PH

- For hand operation and use in electric and air tools
- Acc. to DIN ISO 2351-2, tip as per DIN ISO 8764-1 PH
- Hexagon drive as per DIN 3126 - C 6.3 (1/4")
- GEDORE special steel, titanium-nitrided
- Sales unit 5 pieces each**

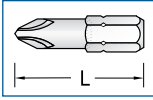

Code	No.	Φ PH	L	⌀	⊞
1828533	TIN 690 1	1	25	5	5
1828541	TIN 690 1 L	1	50	12	5
1828568	TIN 690 2	2	25	6	5
1828576	TIN 690 2 L	2	50	12	5
1828584	TIN 690 3	3	25	6	5
1828592	TIN 690 3 L	3	50	13	5

TIN 690 PZD

SCREWDRIVER BIT for cross-head screws PZ

- For hand operation and use in electric and air tools
- Acc. to DIN ISO 2351-2, tip as per DIN ISO 8764-1 PZ
- Hexagon drive as per DIN 3126 - C 6.3 (1/4")
- GEDORE special steel, titanium-nitrided
- Sales unit 5 pieces each**

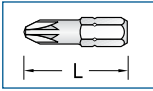

Code	No.	Φ PZ	L	⌀	⊞
1828606	TIN 690 PZD 1	1	25	5	5
1828614	TIN 690 PZD 1 L	1	50	12	5
1828622	TIN 690 PZD 2	2	25	6	5
1828630	TIN 690 PZD 2 L	2	50	13	5
1828649	TIN 690 PZD 3	3	25	6	5
1828657	TIN 690 PZD 3 L	3	50	13	5

TIN 687 TX

SCREWDRIVER BIT for recessed TORX® head screws

- For hand operation and use in electric and air tools
- Hexagon drive as per DIN 3126 - C 6.3 (1/4")
- GEDORE special steel, titanium-nitrided
- TORX® is a registered trademark of Acument Intellectual Properties, LLC. USA
- Sales unit 5 pieces each**

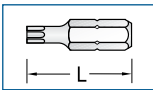

Code	No.	Φ	⊞	mm	L	⌀	⊞
1828460	TIN 687 TX T10	T10	M3 - M3,5	2.74	25	5	5
1828479	TIN 687 TX T15	T15	M3,5 - M4	3.27	25	5	5
1828487	TIN 687 TX T20	T20	M4 - M5	3.86	25	6	5
1828495	TIN 687 TX T25	T25	M4,5 - M5	4.43	25	6	5
1828509	TIN 687 TX T27	T27	M4,5 - M6	4.99	25	6	5
1828517	TIN 687 TX T30	T30	M6 - M7	5.52	25	6	5
1828525	TIN 687 TX T40	T40	M7 - M8	6.65	25	7	5

BIT SETS 6.3 MM (1/4")

671-022

BIT SET 22 pieces

- Extra slim bit reversible ratchet with most popular bit sizes
- For working in extremely confined spaces
- In plastic case
- Dimensions: 160 x 95 x 38 mm
- TORX® = reg. trademark of Acument Intellectual Properties, LLC. USA



Code	No.	Ratchet	Sockets	Accessories	⌀	⊞
1814567	671-022	671	⊖ 680 4 5,5 6,5 8 ● 685 3 4 5 6 ⊕ 690 1 2 ⊕ 690 PZD 1 2 3 ● 687 TX T10 T15 T20 T25 T27 T30	676 699	377	1

620-024

BIT SET 24 pieces

- In plastic case
- Dimensions: 110 x 65 x 31 mm
- TORX® = reg. trademark of Acument Intellectual Properties, LLC. USA



Code	No.	Sockets	Accessories	⌀	⊞
1815695	620-024	⊖ 680 4 6,5 ● 685 3 4 5 6 ● 685 X 5 6 8 ⊕ 690 1 2 ⊕ 690 PZD 1 2 3 ● 687 TX T8 T9 T10 T15 T20 T25 T27 T30 T40	620	185	1



693-024

BIT SET 24 pieces

- With No. 2093 U-3 T-handle ratchet and 2093 HR-94 hand ratchet
- In plastic case
- Dimensions: 160 x 95 x 38 mm
- TORX* = reg. trademark of Acument Intellectual Properties, LLC. USA



Code	No.	Ratchet	Sockets	Accessories	⚙️	📦
1814524	693-024	2093 U-3 T 2093 HR-94	⊖ 680 4 6,5 ● 685 3 4 5 6 ⊕ 690 1 2 ⊕ 690 PZD 1 2 3 ⊕ 687 TX T8 T9 T10 T15 T20 T25 T27 T30 T40	2090-6 620	389	1

698-024

BIT SET 24 pieces

- In plastic case
- Dimensions: 110 x 65 x 31 mm
- TORX* = reg. trademark of Acument Intellectual Properties, LLC. USA



Code	No.	Sockets	Accessories	⚙️	📦
1815709	698-024	⊖ 680 4 6,5 ● 685 3 4 5 6 ● 685 X 5 6 8 ⊕ 690 1 2 ⊕ 690 PZD 1 2 3 ⊕ 687 TX T8 T9 T10 T15 T20 T25 T27 T30 T40	698	198	1

ACCESSORIES FOR BITS 6.3 MM (1/4")

KB 619 - KB 630

ADAPTOR PIECES for screwdriver bits

- Acc. to DIN 7427 Form A
- Hex recess drive as per DIN 3126 - D 6.3 (1/4") and square drive Form G as per DIN 3121
- For hand-operated or power tools
- For use in power tools, we recommend the use of a locking ring and pin
- Manganese-phosphated
- * Length not standardised

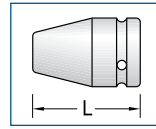

Code	No.	*	⊖*	⊖	□*	□	L	⚙️	📦
6524150	KB 619		1/4	6.3	1/2	12.5	35	72	10
6524230	KB 620		1/4	6.3	1/4	6.3	25	17	10
6530040	KB 630	*	1/4	6.3	3/8	10.0	30	40	5

620 - 630

BIT ADAPTOR 1/4"

- Hex recess drive as per DIN 3126 - D 6.3 (1/4") and square drive as per DIN 3120 - C 6.3 (1/4") / C 10 (3/8")



Code	No.	⊖*	⊖	□*	□	↳mm↳	⚙️	📦
1649329	620	1/4	6.3	1/4	6.3	25	20	1
1973312	630	1/4	6.3	3/8	10.0	25	25	1



635

PICKUP TOOL FOR BITS

- Practical pickup tool for easy bit changing without damaging the profiles
- Suitable for 4 mm, 6.3 mm (1/4") and 8 mm (5/16") bits
- Protects hands and bit profiles
- No more slipping with oily or damp fingers, even with bits deeply recessed in the bit holder



Code	No.	⚙️	📦
2000253	635	10	1

670

BIT SCREWDRIVER 1/4"

- Hex recess drive as per DIN 3126 - D 6.3 (1/4"), for bits
- Magnetic screw retainer
- GEDORE vanadium steel

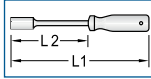

Code	No.	□"	○	L ₁	L ₂	↳mm↳	↳mm↳	↳mm↳
6536590	670	1/4	6.3	210	100	140	10	

670 K

BIT SCREWDRIVER 1/4" short pattern

- Hex recess drive as per DIN 3126 - D 6.3 (1/4"), for bits
- Magnetic screw retainer
- GEDORE vanadium steel



Code	No.	□"	○	↳mm↳	↳mm↳	↳mm↳	↳mm↳
1953796	670 K	1/4	6.3	80	100	1	

671

BIT REVERSIBLE RATCHET

- With knurled head for quick starting or counter-holding of screws
- Hex recess drive as per DIN 3126 - D 6.3 (1/4")
- Slim line design for working in confined spaces



Code	No.	□"	○	∠°	↳mm↳	mm↳	↳mm↳	↳mm↳
6535350	671	1/4	6.3	15	127	18.3	108	5

Features

Slimline design for working in confined spaces

(1) Bit ratchet and bit

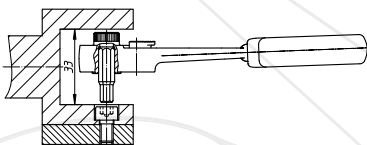

(2+3) Ratchet and socket

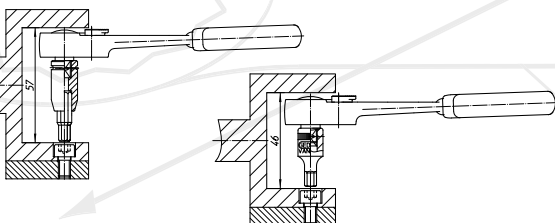

672

BIT EXTENSION 1/4"

- Hex recess drive as per DIN 3126 - D 6.3 (1/4")
- Hex drive as per DIN 3126 - C 6.3 (1/4")



Code	No.	□"	○	□"	○	↳mm↳	↳mm↳
6040700	672	1/4	6.3	1/4	6.3	100	40

673

ADAPTOR

- Acc. to DIN 7428, ISO 3317
- Hexagon drive as per DIN 3126 - E 6.3 (1/4")
- Square drive as per DIN 3121 for power-driven sockets

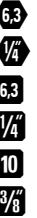

Code	No.	□"	□	□"	○	↳mm↳	↳mm↳	↳mm↳
6536320	673 6,3	1/4	6.3	1/4	6.3	50	16	10
1834878	673 10	3/8	10.0	1/4	6.3	50	26	10

673 K

SOCKET HOLDER short pattern

- Hexagon drive as per DIN 3126 - E 6.3 (1/4")
- Square drive as per DIN 3120 - A 6.3 (1/4")



Code	No.	□"	□	□"	○	↳mm↳	↳mm↳	↳mm↳
2000245	673 K	1/4	6.3	1/4	6.3	17		1

673 L

SOCKET HOLDER long

- 1/4" hexagon drive and square drive as per DIN 3120 - A 6.3 (1/4")
- Hand operation
- For use with driving handle no. 676, or torque handle no. 2140



Code	No.	□"	□	□"	○	↳mm↳	↳mm↳	↳mm↳
1811061	673 L	1/4	6.3	1/4	6.3	130	50	1



Deviant packing units see article description.

674

BIT SCREWDRIVER with reversible mechanism

- Hexagon drive as per DIN 3126 - D 6.3 (1/4"), with powerful magnetic screw retainer
- Smooth gear mechanism with knurled head for quick starting or counter-holding of screws
- The blue handle makes it possible to tighten even hard-to-turn wood screws
- The ratchet is reversible and fully lockable



Code	No.	⌀"	⌀	mm	mm	mm	⊞
6530710	674	1/4	6.3	55	215	259	5

676

DRIVING HANDLE

- Non-slip 2-component handle
- Recessed hexagon drive 1/4"
- Versatile use



Code	No.	⌀"	⌀	mm	⊞	⊞
1649337	676	1/4	6.3	42	1	

698

BIT HOLDER magnetic

- Hexagon drive as per DIN 3126 - E 6.3 (1/4"), magnetic, and hex recess drive as per DIN 3126 - D 6.3 (1/4")
- Powerful magnetic screw retainer, "automatic holder"



Code	No.	⌀"	⌀	⌀"	⌀	mm	mm	⊞	⊞
1761110	698	1/4	6.3	1/4	6.3	73	36	1	



699

BIT HOLDER for power tools

- Acc. to DIN 7427 Form D
- Hexagon drive as per DIN 3126 - E 6.3 (1/4") and hex recess drive as per DIN 3126 - D 6.3 (1/4")
- With magnetic holder
- Chrome-plated



Code	No.	⌀"	⌀	⌀"	⌀	mm	mm	mm	⊞	⊞
6538610	699	1/4	6.3	1/4	6.3	30	60	23	10	

699 L

BIT HOLDER LONG long

- Hexagon drive as per DIN 3126 - C 6.3 (1/4") and hex recess drive as per DIN 3126 - D 6.3 (1/4")
- With magnetic screw retainer
- Hand operation
- For use with driving handle, No. 676, or torque handle, No. 2140



Code	No.	⌀"	⌀	⌀"	⌀	mm	mm	mm	⊞	⊞
1802437	699 L	1/4	6.3	1/4	6.3	32	130	39	1	

700

BIT HOLDER magnetic

- Quick-grip system for hex bits as per DIN 3126 - C 6.3 + E 6.3 (1/4")



Code	No.	⌀"	⌀	⌀"	⌀	⌀	mm	mm	mm	⊞	⊞
6530550	700	1/4	6.3	1/4	6.3	14	51	26	1		

169

MAGAZINE HANDLE SCREWDRIVER

- For highest demands
- With 1/4" recessed hexagon drive
- Magnetic magazine handle with room for 7 bits
- Cap with click-locking
- No. 169 L = empty

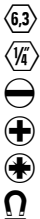

Code	No.	Contents	mm	mm	mm	⊞
6432700	169	⊖ 680 4 5,5 6,5 ⊕ 690 1 2 ⊕ 690 PZD 1 2	115	220	206	1
6432620	169 L		115	220	161	1

8 MM (5/16") HEXAGON DRIVE

880

SCREWDRIVER BIT for slotted head screws

- For hand operation and use in electric and air tools with extra heavy loadings,
- Acc. to DIN ISO 2351-1
- Hexagon drive as per DIN 3126 - C 8 (5/16")
- GEDORE special vanadium steel, gun-metal finish

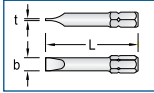

Code	No.	b	t	L	↕	☒
6566740	880 5,5	5.5	0.8	41	12	10
6566820	880 6,5	6.5	1.2	41	13	10
6566900	880 7	7.0	1.2	41	14	10
6567040	880 8	8.0	1.6	41	15	10
6567120	880 9	9.0	1.6	41	16	10
6567200	880 10	10.0	1.6	41	19	10
6567390	880 12	12.0	2.0	41	237	10
6567470	880 14	14.0	2.5	41	29	10

885

SCREWDRIVER BIT for in-hex screws

- For hand operation and use in electric and air tools with extra heavy loadings
- Acc. to DIN ISO 2351-3
- Hexagon drive as per DIN 3126 - C 8 (5/16")
- GEDORE special vanadium steel, gun-metal finish

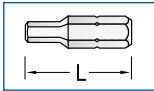

Code	No.	● mm	ISO 4762	DIN 7984	L	↕	☒
6568010	885 3	3	M4	M5	30	9	10
6568280	885 4	4	M5	M6	30	10	10
6568360	885 5	5	M6	M8	30	11	10
6568440	885 6	6	M8	M10	30	11	10
6568520	885 8	8	M10	M12	30	13	10
6568600	885 10	10	M12	M14	30	171	10

890

SCREWDRIVER BIT for cross-slotted head screws PH

- For hand operation and use in electric and air tools with extra heavy loadings
- Acc. to DIN ISO 2351-2, tip as per DIN ISO 8764-1 PH
- Hexagon drive as per DIN 3126 - C 8 (5/16")
- GEDORE special vanadium steel, gun-metal finish

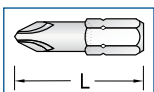

Code	No.	⊕ PH	L	↕	☒
6571580	890 1	1	32	10	10
6571660	890 2	2	32	10	10
6571740	890 3	3	32	10	10
6571820	890 4	4	32	12	10
6571900	890 4 L	4	38	15	10

890 PZD

SCREWDRIVER BIT for cross-slotted head screws PZ

- For hand operation and use in electric and air tools with extra heavy loadings
- Acc. to DIN ISO 2351-2, tip as per DIN ISO 8764-1 PZ
- Hexagon drive as per DIN 3126 - C 8 (5/16")
- GEDORE special vanadium steel, gun-metal finish

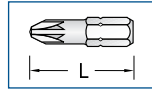

Code	No.	⊕ PZ	L	↕	☒
6553250	890 PZD 1	1	32	9	10
6553330	890 PZD 2	2	32	10	10
6553410	890 PZD 3	3	32	11	10
6553760	890 PZD 4	4	32	13	10

886

SCREWDRIVER BIT for multi-spline screws RIBE®

- For hand operation and use in electric and air tools with extra heavy loadings
- Hexagon drive as per DIN 3126 - C 8 (5/16")
- GEDORE special vanadium steel, gun-metal finish
- RIBE® = reg. trademark of Richard Bergner GmbH & Co. KG, Schwabach, Germany

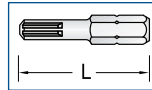

Code	No.	□ mm	L	↕	☒
6570340	886 4	M4	38	10	10
6570420	886 5	M5	38	11	10
6570500	886 6	M6	38	12	10
6570690	886 8	M8	38	13	10
6570770	886 10	M10	38	19	10
6570850	886 12	M12	38	24	10
6570930	886 14	M14	38	30	10

885 X

SCREWDRIVER BIT for multi-point screws XZN

- For hand operation and use in electric and air tools with extra heavy loadings
- Hexagon drive as per DIN 3126 - C 8 (5/16"), tip as per DIN 2325
- GEDORE special vanadium steel, gun-metal finish

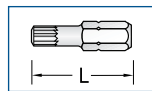

Code	No.	□ mm	L	↕	☒
6569170	885 X 5	M5	28	9	10
6569250	885 X 6	M6	28	9	10
6569330	885 X 8	M8	28	11	10
6569410	885 X 10	M10	38	20	10
6569680	885 X 12	M12	38	25	10
6569760	885 X 14	M14	38	30	10



635



225

887 TX

SCREWDRIVER BIT for recessed TORX® head screws

- For hand operation and use in electric and air tools with extra heavy loadings
- Hexagon drive as per DIN 3126 - C 8 (5/16")
- GEDORE special vanadium steel, gun-metal finish
- TORX® is a registered trademark of Acument Intellectual Properties, LLC. USA

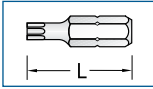

Code	No.	●	□	mm	L	↕	☒
6571070	887 TX T27	T27	M4,5 - M6	4.99	35	11	10
6571150	887 TX T30	T30	M6 - M7	5.52	35	12	10
6571230	887 TX T40	T40	M7 - M8	6.65	35	13	10
6571310	887 TX T45	T45	M8 - M10	7.82	35	14	10
6575140	887 TX T50	T50	M10	8.83	35	15	10

871

BIT REVERSIBLE RATCHET

- With knurled head for quick starting or counter-holding of screws
- Hex recess drive as per DIN 3126 - D 8 (5/16")
- Slim line design for working in confined spaces



Code	No.	○*	○	∠°	↳mm↳	mm↳	↕	☒
6535430	871	5/16	8	15	127	20.2	100	1

KB 819 - KB 830

ADAPTOR PIECES for screwdriver bits

- Acc. to DIN 7427 Form A
- Hex recess drive as per DIN 3126 - D 8 (5/16") and square drive Form G DIN 3121
- For hand-operated or power tools
- For use in power tools, we recommend the use of a locking ring and pin
- Manganese-phosphated
- * Length not standardised

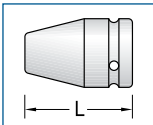
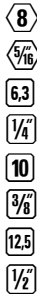

Code	No.	*	○*	○	□*	□	L	↕	☒
6563480	KB 819		5/16	8	1/2	12.5	35	75	5
6563560	KB 820	*	5/16	8	1/4	6.3	25	18	1
6563800	KB 830		5/16	8	3/8	10.0	30	40	1

872

BIT EXTENSION 5/16"

- Hex recess drive as per DIN 3126 - D 8 (5/16")
- Hex drive as per DIN 3126 - C 8 (5/16")



Code	No.	●*	●	○*	○	↳mm↳	↕
6040890	872	5/16	8	5/16	8	100	50

870

BIT SCREWDRIVER

- Hex recess as per DIN 3126 - D 8 (5/16"), for bits
- Magnetic screw retainer
- GEDORE vanadium steel

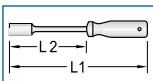

Code	No.	○*	○	L ₁	L ₂	↕	☒
6565500	870	5/16	8	210	100	131	1



871-021

BIT SET 24 pieces

- Extra slim bit ratchet with most popular bit sizes
- For working in extremely confined spaces
- Bits easy to see, always at hand, fitted into shaped plastic insert in shock-proof plastic case, dimensions: 200 x 120 x 38 mm
- TORX® = reg. trademark of Acument Intellectual Properties, LLC. USA



Code	No.	Ratchet	Sockets	Accessories	↕	☒
6570180	871-021	871	⊖ 880 5,5 6,5 8 10 ● 885 3 4 5 6 8 ⊕ 890 2 3 ⊕ 890 PZD 2 3 4 ● 887 TX T27 T30 T40 T45 T50	☒ 872	717	1



$\text{Ø}41.5$

$\text{Ø} D +0.5$

SW



GEDORE

Made in Germany

OREMETER

BZ

20-120 Nm
15-90 lbf-ft

lbf-ft
15-90



++ SECURE PRECISION JOINTS +



SERVICE / FEATURES

232 - 235,
280 - 287

DREMOMETER MINI
T-FS

1/4"



236 - 237

DREMOMETER
AM-F
Z
SE

1/4" - 1 1/2"

16 - 28

9x12

14x18



238 - 243,
246 - 249



ACCESSORIES DREMOMETER



244 - 245

TORCOFIX 1/4" - 3/4"
K UK US
SE
Z
FS

1/4" - 3/4"



250 - 257

TORQUE SCREWDRIVERS

1/4"



258 - 259

OTHER MECHANICAL TORQUE WRENCHES



260 - 263

END FITTINGS

16 22 28 9x12 14x18



264 - 269

TORQUE MULTIPLIER DREMOPLUS



270 - 275

ELECTRONIC TORQUE WRENCHES TORCOTRONIC



276

TORQUE CALIBRATION ANALYSER



277

EMPTY BOXES



278

TORCOFIX MODULE SYSTEMS



279

231



TORQUE TOOLS

GEDORE TORQUE TOOLS...
TIGHTENING, MEASURING, TESTING!



+ MAXIMUM PRODUCTION DEPTH FROM A SINGLE SOURCE

- Use of the very best steel grades, state-of-the-art machinery and environmentally-friendly production processes
- Our tool experts guarantee precision-like processing and permanent development
- Precise adherence to stringent testing and measuring specifications are proof of maximum product quality.
- Large selection of mechanical and electronic torque wrenches, test equipment, torque multipliers and accessories
- Available singly or in practical sets
- Tailored service packages through to development of special customised tools



MAXIMUM CONTROL DURING PRODUCTION GUARANTEES A CONSTANTLY HIGH LEVEL

- All parts incorporated in the production process - from steel through to the smallest spring - are controlled while all manufacturing and work steps are subject to stringent quality controls.
- After assembly, adjustment and calibration, torque tools are tested for accuracy in the end control stage and given a serial number (unique product identification) and plant test certificate in accordance with the applicable DIN EN ISO standard.
- Within the framework of regular continuous tests, processing quality, repeat accuracy and durability are tested. The results of these tests are integrated directly in optimising the production process.



CONTROLLED SCREW TIGHTENING – RELIABLE AND SAFE FOR MORE THAN 50 YEARS

- Guaranteed high precision and user safety have been a top priority for decades.
- Top-grade industrial quality for the hardest of continuous uses
- Indispensable and very resilient aids for tough everyday workshop environments
- Torque tools are measuring equipment. Over the long term, accuracy can only be assured in the form of regular tests (recalibration) (at least once a year / at the latest after 5000 load cycles).



TOP-LEVEL AUTHORISED CALIBRATION + AND COMPETENT CONTROL

- Own accredited DKD calibration laboratory for torques with (licence for testing in acc. with DKD guidelines 3-7:2003 / 3-8:2003 / DIN EN ISO 6789:2003) the registration number: DKD-K-28201
- National co-operation partner to the German Calibration Service (DKD) since accreditation (DIN EN ISO / IEC 17025) and authorisation by PTB in 2000
- Official examination of all test and measuring equipment once a year in the DKD laboratory by the Physikalisch-Technische Bundesanstalt in Braunschweig (PTB)
- Internal precision testing of all test and measuring equipment at least once every 3 months

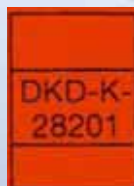
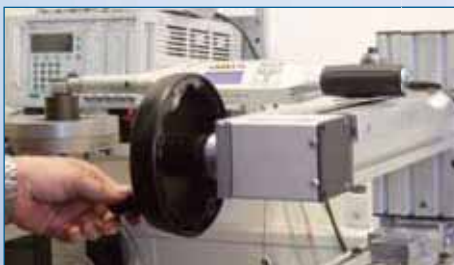



OUR SERVICE - QUALIFIED AND CUSTOMISED

Our expert service is made-to-measure. We offer you a wide range of services, which can be matched quite individually to your requirements. Your problems are our challenges. We can offer you qualified tailormade support in the following areas:

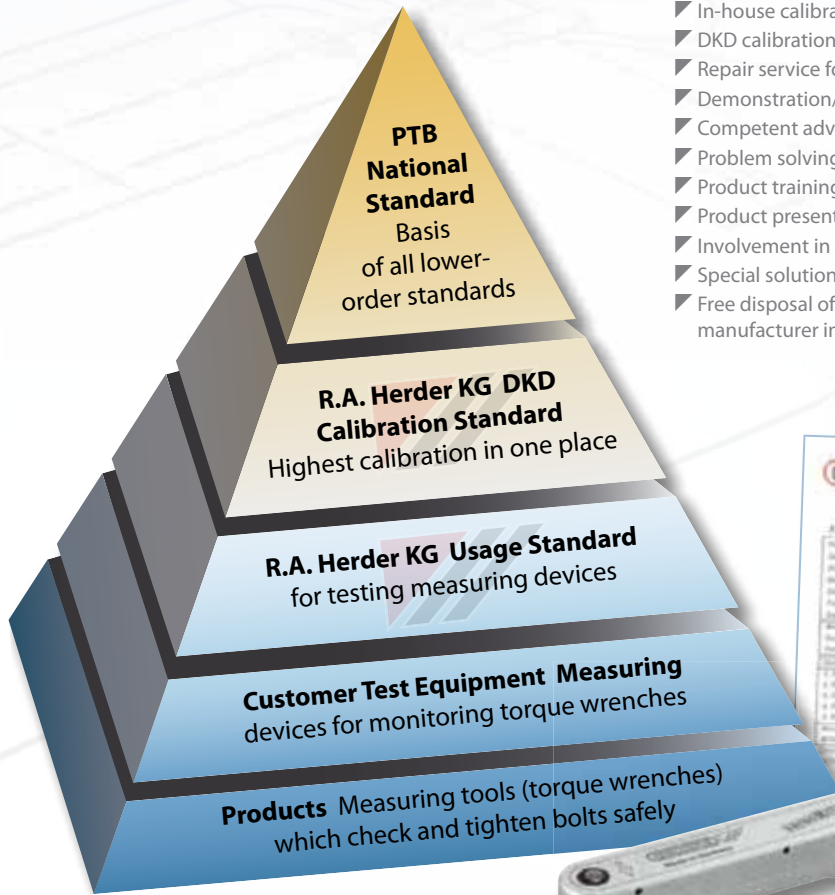

- ✔ In-house calibration according to DIN EN ISO 6789 : 2003
- ✔ DKD calibration in our own accredited DKD calibration laboratory
- ✔ Repair service for our own brands
- ✔ Demonstration/hire tools at favourable prices
- ✔ Competent advice via our service telephone
- ✔ Problem solving with the aid of our technical field service
- ✔ Product training (internal and external)
- ✔ Product presentations (internal and external)
- ✔ Involvement in your in-house fairs
- ✔ Special solutions in the engineering field / RAHSOL SOLUTIONS
- ✔ Free disposal of old torque wrenches or torque testers from any manufacturer in return for the purchase of new goods at a reduced price



+ TECHNICAL FIELD SERVICE

- ✔ Make use of our qualified advice to solve your technical problems, via telephone or on-site during work. We will willingly assist you in making your choice of the most suitable tool - from standard solutions up to and including customised manufacture for specific uses. Product training courses and presentations are also included in our service offering as is assistance at your company exhibitions.

We help you at any time...



SERVICE-TELEPHONE

- ✔ Between 7.30 a.m. and 4.30 p.m., our customer service operators will answer all your questions about products, including technical enquiries, fast and efficiently.
- ✔ Hotline: +49 (0) 1804 37 36 68

Instant help on the service-telephone



DKD CALIBRATION

286,
280
-
287

FACTORY CALIBRATION

287,
280
-
287



HOW IS THE TORQUE MEASURED?

The torque is calculated by multiplying the force "F" applied to the lever with the distance from the pivot point to the point of application "L" (length of the lever). Mathematically, that is expressed as follows: Torque $M_A = \text{Force } F \times \text{Lever } L$

WORKING PRINCIPLE

Force F = 20 newtons

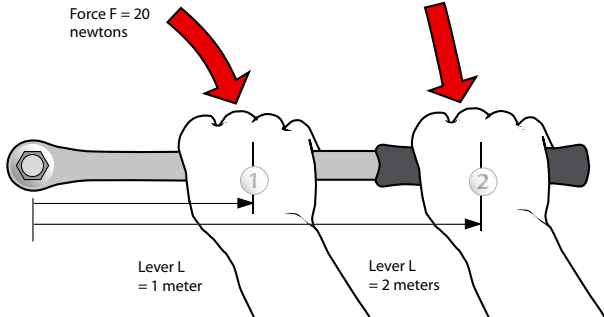

The diagram shows dependencies of force F and lever L on the torque on the base of 2 examples.

In order to determine the relevant torque, we employ the formula „ $M_A = F \times L$ “.

- ① $M_A = F \times L = 20 \text{ N} \times 1 \text{ m} = 20 \text{ N-m}$ (newton meters)
- ② $M_A = F \times L = 20 \text{ N} \times 2 \text{ m} = 40 \text{ N-m}$ (newton meters)

This means that the actual torque applied to the screw changes if the hand's position on the wrench changes.



Also applies for TORCOFIX... Handgrip with user aid

OPERABLE WITHOUT INACCURACIES

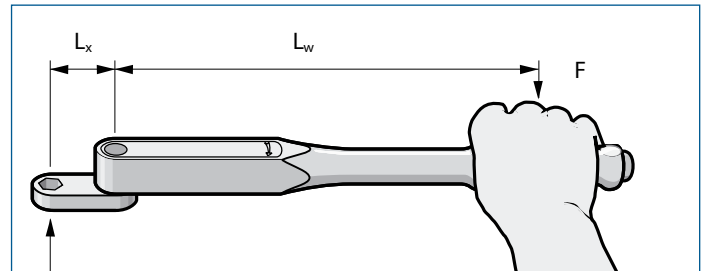
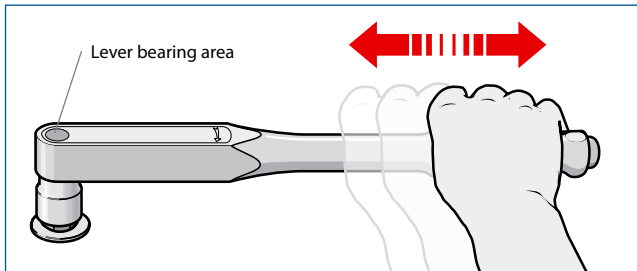

DREMOMETER TYPE MINI - F

In the DREMOMETER, we got around the physical principle explained above using constructional cleverness. Irrespective of where you apply the force - whether it be in the middle of the handgrip or at another position of the DREMOMETER, whether it be with both hands or using an extension tube - the torque set by you is always achieved exactly - without shifts in value! By virtue of an axial position of the pivot point and the output square drive, the DREMOMETER is a tool which is operable without inaccuracies. By contrast to

conventional torque wrenches, this single lever enables tightening without shifts in the measured value and without actuation away from the handgrip adversely affecting the accuracy.

Please note that most conventional torque wrenches can only be actuated at the middle of the handgrip because, otherwise, considerable shifts in value could occur. Do you want to play it safe? Then choose DREMOMETER.

DREMOMETER WITH SPANNERS

When the DREMOMETER is actuated with a special extension spanner, the single lever mentioned above is no longer the case. The attached spanner alters the conditions to the extent that the pivot point is now situated outside of the output square drive and thus a so-called double lever acts upon the screw connection. That has the consequence that the hand's pressure "F" can now only be applied to the middle of the handgrip. Every other pressure point would inevitably lead to shifts in value.

Set torque = Our DREMOMETER and SE operate in accordance with the same principle. Here, the position of the pivot point also shifts to the front. These wrenches must also be actuated at the middle of the handgrip. However, if you are using our spanner end fittings, then the setting torque does not have to be re-calculated on the basis of the below-specified formula. Keep the depth gauges in the certificate in mind. Only if you are using your own designs (therby changing the dimension "L") does the setting torque have to be re-calculated.

The set torque (M_{sw}) when using special spanners is determined along the following lines:

$$\frac{M_A \times l_w}{l_x + l_w}$$

F = Force
 l_1 = Distance (path) from the middle of the handgrip to the pivot point
 L = Distance (path) from the middle of the screw to the pivot point
 M_A = Torque displaced pivot point

➔ **DREMOMETER TYPE MINI - F**

236

➔ **DREMOMETER WITH SPANNERS**

240 - 241



OVERVIEW OF GEDORE PRODUCTS

Series / Type	Precision	Drive	Picto	Hand	Range N-m																		
					5	10	15	20	100	150	200	500	750	1000	1500	2000	3000	4000	5000	6000	48000		
Mech. torque wrench					0,2 - 3.000 N-m																		
DREMOMETER MINI	3%	1/4			2 - 12 N-m																		
DREMOMETER AM - F	3%	1/4 > 1/2			6 - 3000 N-m																		
DREMOMETER BCK	3%	1/2			40 - 200 N-m																		
DREMOMETER Z	3%	16 22 28			8 - 1000 N-m																		
DREMOMETER SE	3%	9x12 14x18			8 - 400 N-m																		
DREMOMETER FS	6%	1/4			1-14 N-m																		
TORCOFIX K	3%	1/4 > 3/4			1-850 N-m																		
TORCOFIX K US	3%	1/4 > 3/4			10 lbf-in - 600 lbf-ft																		
TORCOFIX UK	3%	1/2			10 - 300 N-m																		
TORCOFIX Z	3%	16 22			2 - 850 N-m																		
TOROFIX SE	3%	9x12 14x18			2 - 400 N-m																		
TORCOFIX FS	3%	9x12 14x18			2 - 200 N-m																		
TSN SLIPPER	4%	1/4 > 1/4			3 - 125 N-m																		
TBN KNICKER	4% 6%	16 9x12 (760-00/01)			0,2 - 135 N-m																		
TSP SLIPPER	6%	1/4 > 1/2			1 - 10 N-m																		
TSC SLIPPER	6%	1/4			1 - 10 N-m																		
Typ 83	4%	1/4 > T			0,8 - 2000 N-m																		
Typ 88	4%	3/4 22																	100 - 1500 N-m				
Torque screwdriver					0,02 - 13,6 N-m																		
Typ 755 FS	6%	1/4			0,02 - 13,6 N-m																		
Typ 756 S	6%	1/4			0,05 - 9 N-m																		
Typ 757S	6%	1/4			0,2 - 9 N-m																		
Typ 758 SP	6%	1/4			10 - 500 cN-m/ 14 ozf-in - 40 lbf-in																		
Electr. torque wrench					2 - 1.000 N-m																		
TORCOTRONIC II	1%	1/2			10 - 350 N-m																		
E-TORC II	1%	1/4 9x12 14x18			2 - 1000 N-m																		
Torque testers					0,5 - 3.150 N-m																		
Dremotest E	1%	1/4 > 3/4			0,2 - 1100 N-m																		
E-TP	1%	1/4 > 1/2			0,5 - 3150 N-m																		
Torque multiplier					1.300 - 47.000 N-m																		
Dremoplus 8600	4%	3/4 > T																	1300 - 2700 N-m				
Dremoplus 8601 - 8607	4%	T > 2 1/2																	1700 - 47500 N-m				
Dremoplus 8608	4%	3/4 > T																	1300 - 4500 N-m				
Dremoplus mini 8613	4%	3/4																	1000 N-m				
Dremoplus 8615 - 8660	4%	3/4 > 1 1/2																	1000 - 6000 N-m				



753

TORQUE WRENCH DREMOMETER MINI 2-12 N-m / 18-106 lbf-in

Use:

- ✔ Controlled screw tightening in the range 2-12 N-m
- ✔ For use in almost all industrial manufacturing areas

Features:

- ✔ Classified to DIN EN ISO 6789:2003 Type II Class A, with a factory certificate. Working accuracy: +/- 3% tolerance of scale set torque. The specification of the standard (+/- 4%) is exceeded.
- ✔ Torque wrench with 1/4" square drive with ball locking device DIN 3120 - A 6.3, similar to ISO 1174, for controlled clockwise tightening
- ✔ Automatic short-path actuation with tactile impulse and audible signal
- ✔ Lightweight plastic casing, made from high-grade, glass-fibre reinforced polyamide, with soft-grip handle
- ✔ Dual scale with a scale graduation of 0.5 N-m and 5 lbf-in
- ✔ Additional micrometer scale for setting interim values with N-m, graduations of 0.05 N-m
- ✔ Window with a magnifying-glass effect
- ✔ Locking button enables reliable locking of the torque setting

Scope of delivery:

- ✔ Torque wrench type MINI (if a set is ordered this includes the accessories listed in the tables)
- ✔ With test certificate acc. to DIN EN ISO 6789, traceable to national standards



6,3
1/4"

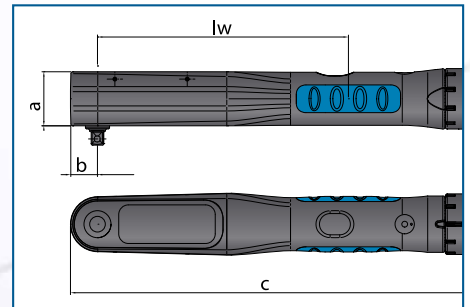

Code	No.	Type	■*	■	N-m	lbf-in	مقياس	lw	a	b	c	مقياس
1957694	753-11	MINI	1/4	6.3	2-12	18-106	0,5 N-m / 5 lbf-in + 0,05 N-m	130	28	14	211	320



➔ **754**

244

➔ **2090**

156

➔ **20 IN 20**

152

763

TORQUE WRENCH DREMOMETER T-FS pre-set, 1-14 N-m

Use:

- Power-saving application for torques which are usually in the range of torque screwdrivers
- E.g. securing modules on solar power systems, tool supports etc.; wherever the torques are too large for classic torque screwdrivers

Features:

- Torque wrench series with 14 pre-set models for serial production
- Working accuracy in accordance with DIN EN ISO 6789:2003 Type II Class E (+/- 6%)
- Lightweight and robust - housing made of a high-quality aluminium alloy
- With certificate acc. to DIN EN ISO 6789:2003, traceable via in-house DKD laboratory to national standards

Special ranges are available on request

6,3

1/4"

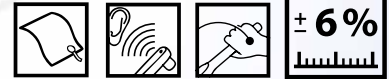

Code	No.	■*	■	N-m	STC
1947907	763-01	1/4	6.3	1 N-m	241
1947915	763-02	1/4	6.3	2 N-m	241
1947923	763-03	1/4	6.3	3 N-m	241
1947931	763-04	1/4	6.3	4 N-m	241
1947958	763-05	1/4	6.3	5 N-m	241
1947966	763-06	1/4	6.3	6 N-m	241
1947974	763-07	1/4	6.3	7 N-m	241
1947990	763-08	1/4	6.3	8 N-m	241
1948008	763-09	1/4	6.3	9 N-m	241
1948016	763-10	1/4	6.3	10 N-m	241
1948024	763-11	1/4	6.3	11 N-m	241
1948032	763-12	1/4	6.3	12 N-m	241
1948040	763-13	1/4	6.3	13 N-m	241
1948059	763-14	1/4	6.3	14 N-m	241

286, 280 - 287

2099

157

FACTORY CALIBRATION

287 280 - 287



DREMOMETER - PERMANENT PRECISION

TORQUE WRENCH MADE OF HIGH-STRENGTH ALUMINIUM ALLOY

Drive in accordance with application: DREMOMETERS are available for a large variety of applications in controlled screw tightening. The single square drive for controlled clockwise tightening or the double square drive (L) for controlled bi-directional tightening. Special utilisation areas for DREMOMETER with spigot end (Z) and rectangular cavity (SE) particularly for hard-to-access locations and where space is tight. Almost all DREMOMETER models have separate ratchet heads, and there are good reasons for that: It is possible to work with or without the ratchet head function as desired.

Robust and unsusceptible: The full-metal construction of the DREMOMETER makes it particularly unsusceptible to grime and rough handling on construction sites, in workshops and in industry.



Maximum precision: Extended tool life and long life-cycle even if used intensely.



i WORKING PRINCIPLE

The quality lever chain produced in the company's own drop forge reduces the strain on the mechanics to a minimum. The proportioning of the individual levers, which are optimally attuned to each other, gives the DREMOMETER its unique precision and its long tool life.

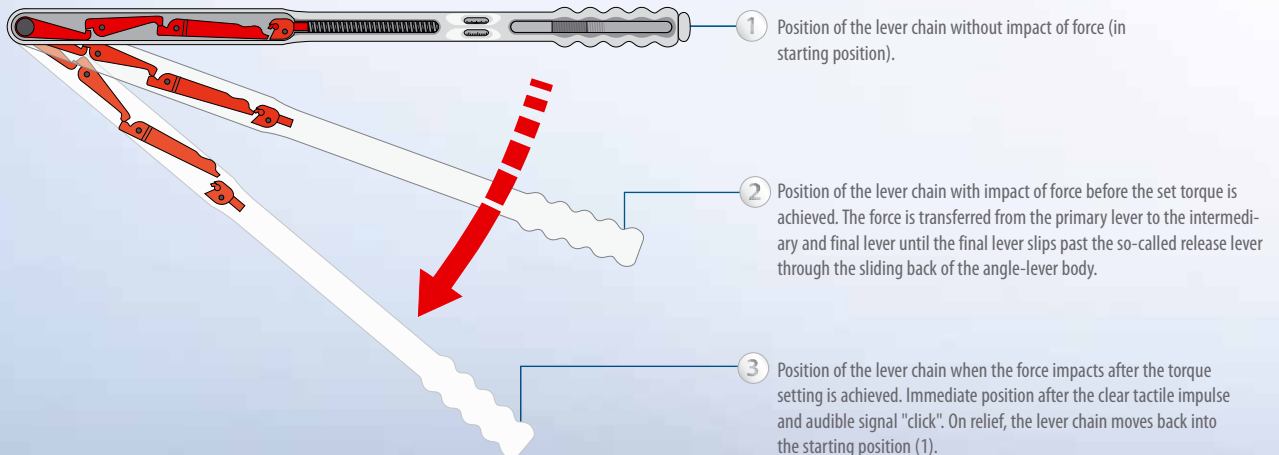



Automatic resetting: The DREMOMETER gives operator an audible signal and tactile impulse and is back in operation in an instant.



Lightweight and pleasant: The aluminium housing and the ergonomically designed handgrip enable simple and safe operation over wide tightening ranges.

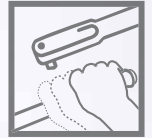

Working accuracy: +/- 3% tolerance of scale set torque. Includes a test certificate according to DIN EN ISO 6789. Serial number on the wrench and on the certificate for unambiguous product identification, traceable to national standards.



Scale: Clear dual scale N-m and lbf-in / lbf-ft on every DREMOMETER (apart from models E / EL / EK / EKL / F).



i DREMOMETER TYPE MINI - F OPERABLE WITHOUT INACCURACIES

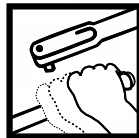

► Regardless of where you apply the force, at the center of the handgrip or another part of the DREMOMETER, with both hands or using an extension ube, your torque setting will always be attained, without shifts in value.

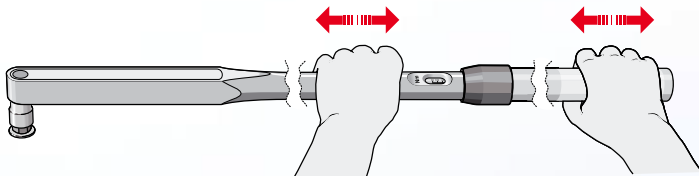

Due to its unique single-axis location of the centre of rotation and the output square drive, the DREMOMETER is a tool that can be operated free from errors. In contrast to conventional torque wrenches, this single lever enables tightening without shifts in the measured value and without interference caused by activation outside of the handgrip.

► (However, value shifts are possible when activating the DREMOMETER with special wrenches or when using wrenches with different depth gauges).

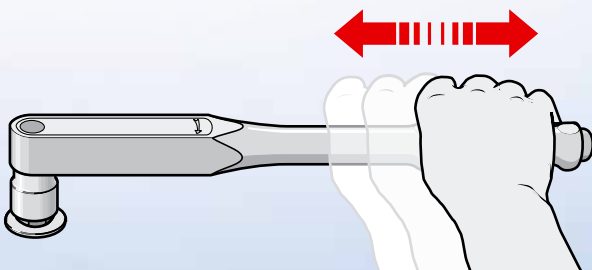

i TECHNOLOGY

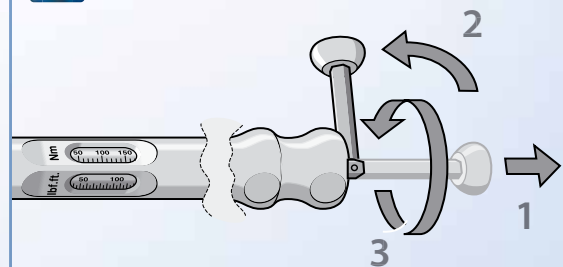

► Setting of the torque value to N-m or alternatively to lbf-in / lbf-ft by the non-losable hexagon key in the handgrip.
 ► The smooth-running mechanism enables the setting to be made quickly without significant force needing to be applied.

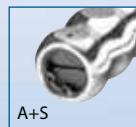

A+S

► All DREMOMETERS are also available with locking and safety device (A+S).

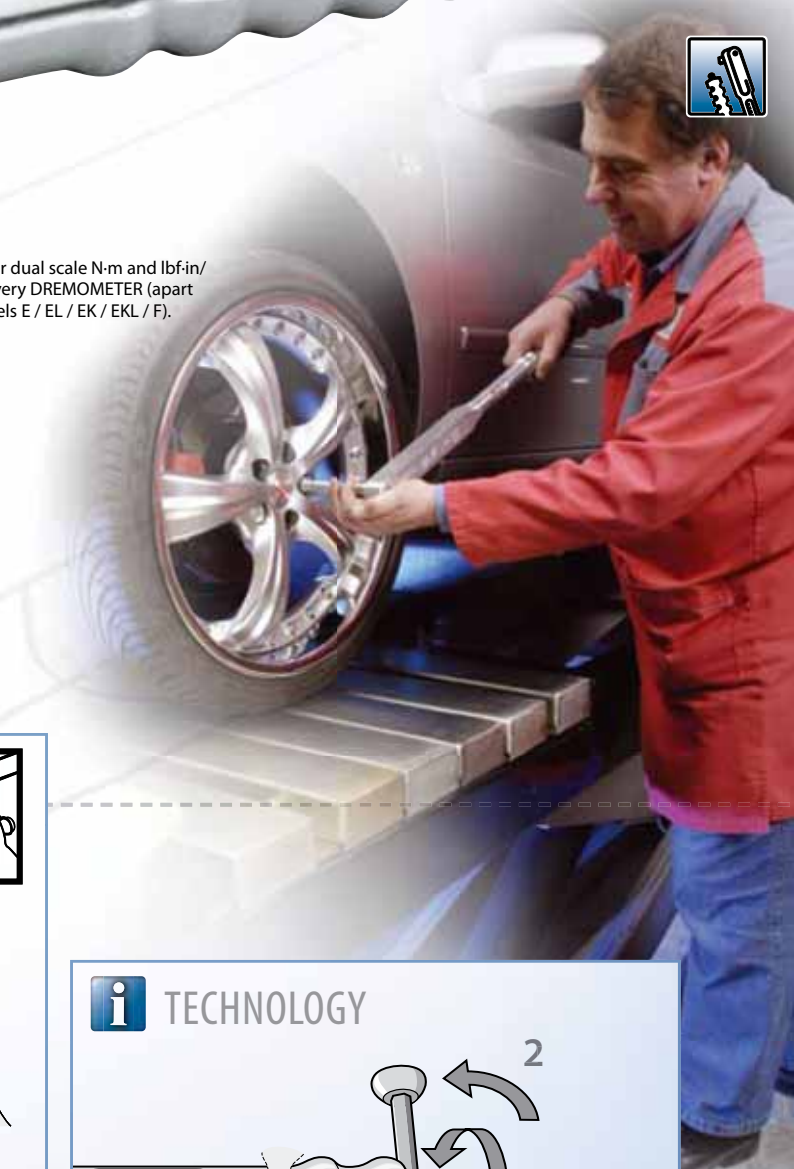



ALL THE BENEFITS AT A SINGLE GLANCE

+ SQUARE DRIVE



- In the DREMOMETER, the output square drive and the pivot point of the primary lever are situated on a single axis.
- Advantage: The absolute accuracy always remains unchanged in every case. Even if the tool is operated outside of the handgrip or with an extension tube.

+ LEVER CHAIN

- The integrated lever chain reduces the strain on the measuring mechanics to a minimum which means that the measuring mechanics can thus be constructed with much greater sensitivity.
- Advantage: High accuracy and a long life cycle.

+ DOUBLE SQUARE DRIVE

- DREMOMETER models (except model F) having a double square drive are available on request. Apart from that, separate ratchet heads are available for almost all models (except model F).
- Advantage: Controlled counter-clockwise tightening and work in very narrow spaces are possible without any problems.



+ SCALE

- Two scales on each DREMOMETER indicate N-m and the common US unit of torque measurement (apart from types E - F).
- Advantage: Exact reading even for lbf-in or lbf-ft.

+ HANDGRIP

- The nice-to-hold handgrip enables safe work and less operator fatigue. The full-metal construction makes DREMOMETER models particularly robust.
- Advantage: A high level of dependability even following tough long term work.

+ TEST CERTIFICATE

- All DREMOMETER models include a test certificate according to DIN EN ISO 6789:2003.
- Advantage: Guaranteed accuracy +/-3 % of the adjusted scale value.



8554 AM - 8572 F

TORQUE WRENCH DREMOMETER AM - F 6-3000 N-m

Use:

- Controlled screw tightening in the range 6 - 3000 N-m
- For use in almost all industrial manufacturing areas

Features:

- With certificate acc. to DIN EN ISO 6789:2003, traceable via in-house DKD laboratory to national standards
- Automatic short-path actuation with tactile impulse and audible signal
- Dual scale (except for type E-F) with corresponding scale graduation (see table)
- Type B, BC, C with push-button release
- Type BCK with integrated ratchet function

Technical advantage/Function:

- Classified to DIN EN ISO 6789:2003 Type II Class A, with a factory certificate. Working accuracy: +/- 3% tolerance of scale set torque. The specification of the standard (+/- 4%) is exceeded.
- Lightweight and robust (as housing is made of an aluminium alloy), very workshop-friendly
- No inaccuracies whether used with both hands or held away from the handle (as for standard torque wrenches) Both the square drive and fulcrum are on an axis which ensures a high degree of user safety; can be extended to reduce the user's working load.
- Extremely low wear attributable to reduced forces in a unique lever mechanism
- Forged lever chain from our own quality forge
- Maximum precision even when subjected to extreme continuous use
- Long life cycles and tool lives
- Easy operation - fast and safe torque tightening
- Easy adjustment thanks to attractive adjusting button secured against loss at the end of the handle
- Single- and double-square drive for controlled bi-directional tightening

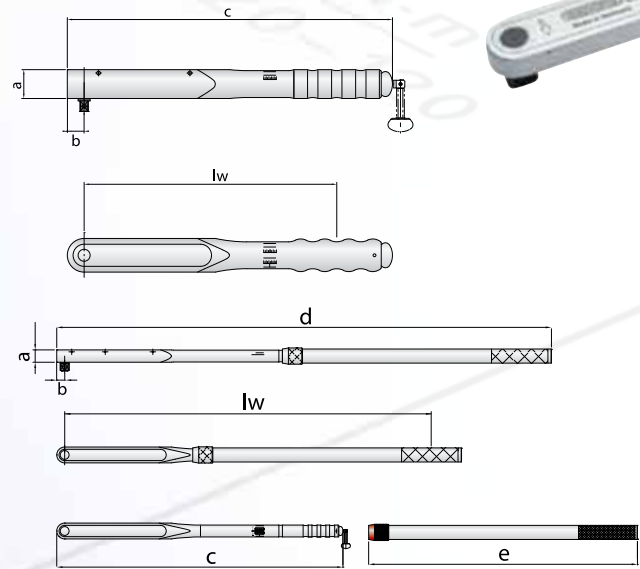

Code	No.	Icon	Type	■"	■
7775440	8554-01	☑	AM	1/4	6.3
7775870	8559-01	☑	AML	1/4	6.3
7682000	8560-01	☑	A	3/8	10.0
7682190	8565-01	☑	AL	3/8	10.0
7683320	8561-01	☑	B	1/2	12.5
7683400	8566-01	☑	BL	1/2	12.5
7685530	8573-00	☑	BC	1/2	12.5
7683670	8578-00	☑	BCL	1/2	12.5
1905449	8573-10	☑	BCK	1/2	12.5
7685450	8562-10	☑	C	1/2	12.5
7685960	8567-10	☑	CL	1/2	12.5
7688470	8570-10	☑	CD	3/4	20.0
7688710	8575-10	☑	CDL	3/4	20.0
1427156	8574-10	☑	DS	3/4	20.0
1427121	8579-10	☑	DSL	3/4	20.0
7691500	8563-10	☑	D	3/4	20.0
7691850	8568-10	☑	DL	3/4	20.0
7670180	8563-01	☑	DR	3/4	20.0
7670500	8568-01	☑	DRL	3/4	20.0
7670930	8568-35	☑	DR-LKW	3/4	20.0
7694010	8571-01	☑	DX	3/4	20.0
7694360	8576-01	☑	DXL	3/4	20.0
2311267	8581-01	☑	EK	1	25.0
2311291	8586-01	☑	EKL	1	25.0
7695250	8564-01	☑	E	1	25.0
7695410	8569-01	☑	EL	1	25.0
7717160	8572-01	☑	F	1.1/2	40.0



➔ **8560-03 A**

242

➔ **754**

244



- 6,3
- 10
- 12,5
- 20
- 25
- 40

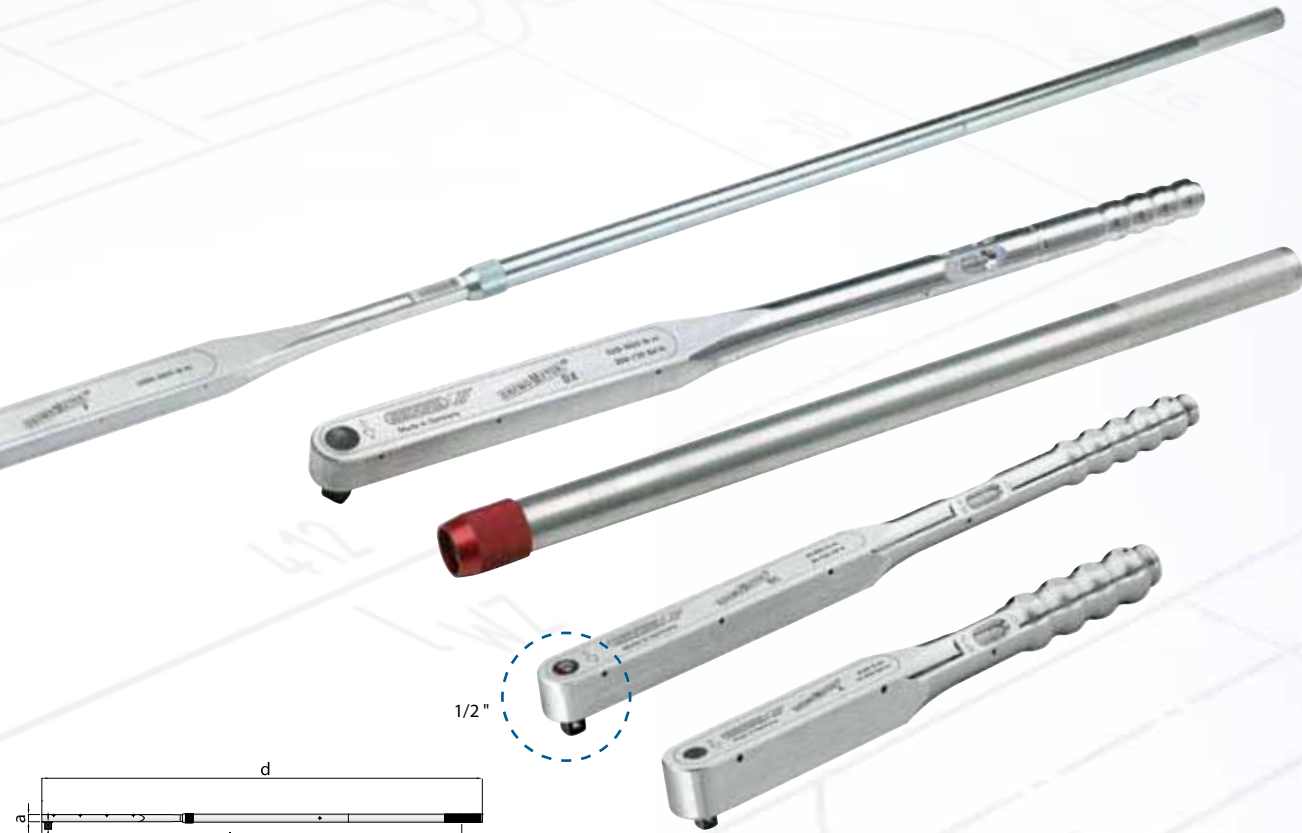

1/2"

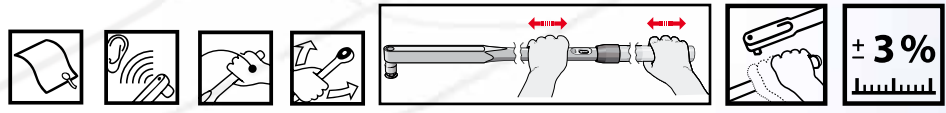
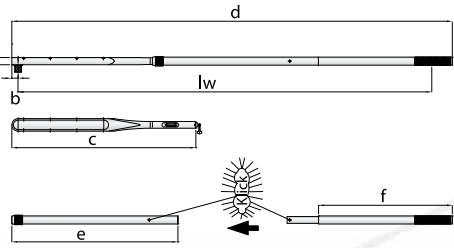

Nm	lbfin	lbfft	المقياس	lw	a	b	c	d	e	f	طول
6-30	50-270	-	1 N-m / 10 lbfin	207	30	15.0	268	-	-	-	580
6-30	50-270	-	1 N-m / 10 lbfin	207	30	15.0	268	-	-	-	580
8-40	70-350	-	5 N-m / 50 lbfin	263	30	17.5	338	-	-	-	1000
8-40	70-350	-	5 N-m / 50 lbfin	263	30	17.5	338	-	-	-	1000
20-120	-	15-90	5 N-m / 5 lbfft	374	30	17.5	462	-	-	-	1500
20-120	-	15-90	5 N-m / 5 lbfft	374	30	17.5	462	-	-	-	1500
40-200	-	30-150	5 N-m / 5 lbfft	463	30	17.5	551	-	-	-	1400
40-200	-	30-150	5 N-m / 5 lbfft	463	30	17.5	551	-	-	-	1300
40-200	-	30-150	5 N-m / 5 lbfft	463	35	20.0	554	-	-	-	1400
50-300	-	35-220	5 N-m / 5 lbfft	529	30	17.5	617	-	-	-	2000
50-300	-	35-220	5 N-m / 5 lbfft	529	30	17.5	617	-	-	-	2000
80-360	-	60-260	5 N-m / 5 lbfft	624	30	22.5	717	-	-	-	2400
80-360	-	60-260	5 N-m / 5 lbfft	624	30	22.5	717	-	-	-	2400
110-550	-	80-400	10 N-m / 10 lbfft	719	35	22.5	812	-	-	-	2900
110-550	-	80-400	10 N-m / 10 lbfft	719	35	22.5	812	-	-	-	2900
140-760	-	100-560	10 N-m / 10 lbfft	719	35	22.5	812	-	-	-	3200
140-760	-	100-560	10 N-m / 10 lbfft	719	35	22.5	812	-	-	-	3200
140-760	-	100-560	10 N-m / 10 lbfft	1297	35	22.5	812	1413	772	-	5000
140-760	-	100-560	10 N-m / 10 lbfft	1297	35	22.5	812	1413	772	-	5000
140-760	-	100-560	10 N-m / 10 lbfft	1297	35	22.5	812	1413	772	-	12300
520-1000	-	380-730	10 N-m / 10 lbfft	1297	35	22.5	812	1413	772	-	5600
520-1000	-	380-730	10 N-m / 10 lbfft	1297	35	22.5	812	1413	772	-	5600
600-1500	-	-	25 N-m	1873	40	30.0	932	1608	925	-	10800
600-1500	-	-	25 N-m	1873	40	30.0	932	1608	925	-	10800
750-2000	-	-	50 N-m	1873	40	30.0	932	2353	925	745	11600
750-2000	-	-	50 N-m	1873	40	30.0	932	2353	925	745	11600
1500-3000	-	-	50 N-m	2313	40	35.0	1025	2453	925	745	13200

Deviant packing units see article description.



753-12 - 8572-02

DREMOMETER



6,3 **1/4"**
10 **3/8"**
12,5 **1/2"**
20 **3/4"**
25 **1"**
40 **1 1/2"**

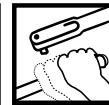



Code	No.	⚙	Type	■"	■	Inclusion	↔
1957708	753-12		MINI	1/4	6.3	in plastic cassette	0.6
7674090	8554-02	↔	AM	1/4	6.3	in plastic cassette	0.9
7673790	8559-02	↔	AML	1/4	6.3	in plastic cassette	0.9
7682270	8560-02	↔	A	3/8	10.0	in a sheet-metal case	2.2
7682350	8565-02	↔	AL	3/8	10.0	in a sheet-metal case	2.2
7683830	8561-02	↔	B	1/2	12.5	in a sheet-metal case	2.8
7684130	8566-02	↔	BL	1/2	12.5	in a sheet-metal case	2.8
7683590	8573-02	↔	BC	1/2	12.5	in a sheet-metal case	3.5
7683750	8578-02	↔	BCL	1/2	12.5	in a sheet-metal case	3.5
7686340	8562-20	↔	C	1/2	12.5	in a sheet-metal case	3.6
7686690	8567-20	↔	CL	1/2	12.5	in a sheet-metal case	3.6
7689280	8570-20	↔	CD	3/4	20.0	in a sheet-metal case	6.2
7689520	8575-20	↔	CDL	3/4	20.0	in a sheet-metal case	6.2
1436112	8574-20	↔	DS	3/4	20.0	in a sheet-metal case	6.7
1436120	8579-20	↔	DSL	3/4	20.0	in a sheet-metal case	6.7

Code	No.	⚙	Type	■"	■	Inclusion	↔
7692070	8563-20	↔	D	3/4	20.0	in a sheet-metal case	7.7
7692310	8568-20	↔	DL	3/4	20.0	in a sheet-metal case	7.7
7670260	8563-02	↔	DR	3/4	20.0	in a sheet-metal case with extension tube	8.8
7670690	8568-02	↔	DRL	3/4	20.0	in a sheet-metal case with extension tube	8.8
7694520	8571-02	↔	DX	3/4	20.0	in a sheet-metal case with extension tube	10.0
7694600	8576-02	↔	DXL	3/4	20.0	in a sheet-metal case with extension tube	10.0
7695680	8564-02	↔	E	1	25.0	in sheet-metal case with 2 extension tubes	24.3
7695840	8569-02	↔	EL	1	25.0	in sheet-metal case with 2 extension tubes	24.3
2311275	8581-02	⚙	EK	1	25.0	in sheet-metal case with 1 extension tube	24.3
2311305	8586-02	⚙	EKL	1	25.0	in sheet-metal case with 1 extension tube	24.3
7717240	8572-02	↔	F	1.1/2	40.0	in sheet-metal case with 2 extension tubes	24.0

753-13 - 8572-03

DREMOMETER SETS MM



6,3 **1/4"** **10**
3/8" **12,5** **1/2"**
20 **3/4"** **25**
1" **40** **1 1/2"**



Code	No.	⚙	Type	■"	■	Inclusion	↔
1957724	753-13		MINI	1/4	6.3	Set mm ○ 4 5 5,5 6 7 8 9 10 ⊕ 1 2 3 ⊖ 4 5,5 6,5 ● 3 4 5 6 ⊙ T20 T27 T30 ⊙ 754-00 ↔ 55 + 97 mm 2098	1.0
7674170	8554-03	↔	AM	1/4	6.3	Set mm ○ 8 9 10 11 12 13 14 ⊕ 3 ⊖ 5,5 ● 4 5 6 8 ⊙ T20 T27 T30 ⊙ 754-00 ↔ 55 + 97 mm	1.3
7675060	8559-03	↔	AML	1/4	6.3	Set mm ○ 8 9 10 11 12 13 14 ⊕ 3 ⊖ 5,5 ● 4 5 6 8 ⊙ T20 T27 T30 ⊙ 754-00 ↔ 55 + 97 mm	1.3
7682430	8560-03	↔	A	3/8	10.0	Set mm ○ 8 10 11 13 14 15 17 19 ● 4 5 6 8 ⊙ 754-01 ↔ 125 + 250 mm	3.1
7682940	8565-03	↔	AL	3/8	10.0	Set mm ○ 8 10 11 13 14 15 17 19 ● 4 5 6 8 ⊙ 754-01 ↔ 125 + 250 mm	3.1
7684480	8561-03	↔	B	1/2	12.5	Set mm ○ 11 13 14 17 19 22 24 ● 6 8 10 12 ⊙ 754-02 ↔ 76 + 125 + 250 mm	4.7
7684640	8566-03	↔	BL	1/2	12.5	Set mm ○ 11 13 14 17 19 22 24 ● 6 8 10 12 ⊙ 754-02 ↔ 76 + 125 + 250 mm	4.7
7683910	8573-03	↔	BC	1/2	12.5	Set mm ○ 11 13 14 17 19 21 22 24 27 ● 6 8 10 12 ⊙ 754-02 ↔ 125 + 250 mm	5.1
7684050	8578-03	↔	BCL	1/2	12.5	Set mm ○ 11 13 14 17 19 21 22 24 27 ● 6 8 10 12 ⊙ 754-02 ↔ 125 + 250 mm	5.1
7687070	8562-30	↔	C	1/2	12.5	Set mm ○ 17 19 22 24 27 30 32 ● 8 10 12 14 ⊙ 754-02 ↔ 76 + 125 + 250 mm	6.0

Code	No.	⚙	Type	■"	■	Inclusion	↔
7687310	8567-30	↔	CL	1/2	12.5	Set mm ○ 17 19 22 24 27 30 32 ● 8 10 12 14 ⊙ 754-02 ↔ 76 + 125 + 250 mm	6.0
7689950	8570-30	↔	CD	3/4	20.0	Set mm ○ 19 22 24 27 30 32 ⊙ 754-04 ↔ 200 + 400 mm	11.0
7690290	8575-30	↔	CDL	3/4	20.0	Set mm ○ 19 22 24 27 30 32 ⊙ 754-04 ↔ 200 + 400 mm	11.0
7692660	8563-30	↔	D	3/4	20.0	Set mm ○ 22 24 27 30 32 36 41 46 ⊙ 754-04 ↔ 200 + 400 mm	13.6
7692900	8568-30	↔	DL	3/4	20.0	Set mm ○ 22 24 27 30 32 36 41 46 ⊙ 754-04 ↔ 200 + 400 mm	13.6
7670340	8563-03	↔	DR	3/4	20.0	Set mm ○ 22 24 27 30 32 36 41 46 ⊙ 754-04 ↔ 200 + 400 mm	14.4
7670770	8568-03	↔	DRL	3/4	20.0	Set mm ○ 22 24 27 30 32 36 41 46 ⊙ 754-04 ↔ 200 + 400 mm	14.4
7670930	8568-35	↔	DR-LKW	3/4	20.0	Set mm ○ 27 30 32 ⊙ 754-04 ↔ 400 mm	12.3
7694870	8571-03	↔	DX	3/4	20.0	Set mm ○ 30 32 36 41 46 50 ⊙ 754-04 ↔ 200 + 400 mm	16.8
7694950	8576-03	↔	DXL	3/4	20.0	Set mm ○ 30 32 36 41 46 50 ⊙ 754-04 ↔ 200 + 400 mm	16.8
7696060	8564-03	↔	E	1	25.0	Set mm ○ 36 41 46 50 55 60 65 70 ⊙ 754-06 ↔ 200 + 400 mm	42.4
7696140	8569-03	↔	EL	1	25.0	Set mm ○ 36 41 46 50 55 60 65 70 ⊙ 754-06 ↔ 200 + 400 mm	42.4
2311283	8581-03	⚙	EK	1	25.0	Set mm ○ 36 41 46 50 55 60 65 70 ⊙ 754-06 ↔ 200 + 400 mm	42.4
2311313	8586-03	⚙	EKL	1	25.0	Set mm ○ 36 41 46 50 55 60 65 70 ⊙ 754-06 ↔ 200 + 400 mm	42.4

**753-14 - 8572-04****DREMOMETER SETS INCH**

- 6,3 1/4"
- 10 3/8"
- 12,5 1/2"
- 20 3/4"
- 25 1"
- 40 1 1/2"

**"AF"**

Code	No.	Type	■"	■	Inclusion	↔
1957732	753-14	MINI	1/4	6.3	<ul style="list-style-type: none"> Set INCH ○ 3/16 7/32 1/4 9/32 5/16 11/32 3/8 7/16" ● 1 2 3 ● 4 5,5 6,5 ● 3 4 5 6 ● T20 T27 T30 ● 754-00 ↔ 55 + 97 mm 2098 	1.0
7674410	8554-04	AM	1/4	6.3	<ul style="list-style-type: none"> Set INCH ○ 9/32 5/16 11/32 3/8 7/16 1/2 9/16 ● 3 ● 5,5 ● 4 5 6 8 ● T20 T27 T30 ● 754-00 ↔ 55 + 97 mm 	1.3
7675140	8559-04	AML	1/4	6.3	<ul style="list-style-type: none"> Set INCH ○ 9/32 5/16 11/32 3/8 7/16 1/2 9/16 ● 3 ● 5,5 ● 4 5 6 8 ● T20 T27 T30 ● 754-00 ↔ 55 + 97 mm 	1.3
7683160	8560-04	A	3/8	10.0	<ul style="list-style-type: none"> Set INCH ○ 3/8 7/16 1/2 9/16 19/32 5/8 11/16 ● 1/4 5/16 3/8 ● 754-01 ↔ 125 + 250 mm 	3.0
7683240	8565-04	AL	3/8	10.0	<ul style="list-style-type: none"> Set INCH ○ 3/8 7/16 1/2 9/16 19/32 5/8 11/16 ● 1/4 5/16 3/8 ● 754-01 ↔ 125 + 250 mm 	3.0
7684990	8561-04	B	1/2	12.5	<ul style="list-style-type: none"> Set INCH ○ 7/16 1/2 9/16 19/32 5/8 11/16 3/4 25/32 13/16 7/8 15/16 1" ● 5/16 3/8 1/2" ● 754-02 ↔ 76 + 125 + 250 mm 	5.3
7685100	8566-04	BL	1/2	12.5	<ul style="list-style-type: none"> Set INCH ○ 7/16 1/2 9/16 19/32 5/8 11/16 3/4 25/32 13/16 7/8 15/16 1" ● 5/16 3/8 1/2" ● 754-02 ↔ 76 + 125 + 250 mm 	5.3
7684720	8573-04	BC	1/2	12.5	<ul style="list-style-type: none"> Set INCH ○ 1/2 9/16 5/8 11/16 3/4 13/16 7/8" ● 5/16 3/8 1/2 9/16" ● 754-02 ↔ 125 + 250 mm 	4.9

Code	No.	Type	■"	■	Inclusion	↔
7684210	8578-04	BCL	1/2	12.5	<ul style="list-style-type: none"> Set INCH ○ 1/2 9/16 5/8 11/16 3/4 13/16 7/8" ● 5/16 3/8 1/2 9/16" ● 754-02 ↔ 125 + 250 mm 	4.9
7687820	8562-40	C	1/2	12.5	<ul style="list-style-type: none"> Set INCH ○ 3/4 25/32 13/16 7/8 15/16 1" 1.1/16 1.1/8 1.1/4" ● 3/8 1/2 9/16 5/8" ● 754-02 ↔ 76 + 125 + 250 mm 	6.2
7688120	8567-40	CL	1/2	12.5	<ul style="list-style-type: none"> Set INCH ○ 3/4 25/32 13/16 7/8 15/16 1" 1.1/16 1.1/8 1.1/4" ● 3/8 1/2 9/16 5/8" ● 754-02 ↔ 76 + 125 + 250 mm 	6.2
7690530	8570-40	CD	3/4	20.0	<ul style="list-style-type: none"> Set INCH ○ 7/8 15/16 1" 1.1/8 1.1/4 1.3/8 1.1/2 1.5/8" ● 754-04 ↔ 200 + 400 mm 	11.3
7691180	8575-40	CDL	3/4	20.0	<ul style="list-style-type: none"> Set INCH ○ 7/8 15/16 1" 1.1/8 1.1/4 1.3/8 1.1/2 1.5/8" ● 754-04 ↔ 200 + 400 mm 	11.3
7693200	8563-40	D	3/4	20.0	<ul style="list-style-type: none"> Set INCH ○ 1" 1.1/8 1.1/4 1.5/16 1.3/8 1.7/16 1.1/2 1.5/8 1.3/4 1.13/16 1.7/8 2" ● 754-04 ↔ 200 + 400 mm 	13.3
7693550	8568-40	DL	3/4	20.0	<ul style="list-style-type: none"> Set INCH ○ 1" 1.1/8 1.1/4 1.5/16 1.3/8 1.7/16 1.1/2 1.5/8 1.3/4 1.13/16 1.7/8 2" ● 754-04 ↔ 200 + 400 mm 	13.3
7670420	8563-04	DR	3/4	20.0	<ul style="list-style-type: none"> Set INCH ○ 1" 1.1/8 1.1/4 1.5/16 1.3/8 1.7/16 1.1/2 1.5/8 1.3/4 1.13/16 1.7/8 2" ● 754-04 ↔ 200 + 400 mm 	16.7
7670850	8568-04	DRL	3/4	20.0	<ul style="list-style-type: none"> Set INCH ○ 1" 1.1/8 1.1/4 1.5/16 1.3/8 1.7/16 1.1/2 1.5/8 1.3/4 1.13/16 1.7/8 2" ● 754-04 ↔ 200 + 400 mm 	16.7
7695170	8571-04	DX	3/4	20.0	<ul style="list-style-type: none"> Set INCH ○ 1.1/8 1.1/4 1.3/8 1.1/2 1.3/4 1.7/8" ● 754-04 ↔ 200 + 400 mm 	16.0
7695330	8576-04	DXL	3/4	20.0	<ul style="list-style-type: none"> Set INCH ○ 1.1/8 1.1/4 1.3/8 1.1/2 1.3/4 1.7/8" ● 754-04 ↔ 200 + 400 mm 	16.0



➔ **8600**

272



MECHANICAL TORQUE WRENCHES

DREMOMETER MINI-F / Z / SE

754

RATCHET HEADS DREMOMETER

Use:

- Enables controlled torque tightening in combination with a DREMOMETER torque wrench (Type MINI - E)

Inclusion:

- Fine-pitched, sturdy ratchet head
- With 1/4", 3/8", 1/2", 3/4" or 1" output square drive
- Clockwise models (no. 754-00 to -06)
- Counter-clockwise models (no. 754-11 to -16)
- Made of chrome-vanadium steel

Scope of delivery:

- Ratchet head
- Single packed in poly-bag

- | | |
|------|------|
| 6,3 | 1/4" |
| 10 | 3/8" |
| 12,5 | 1/2" |
| 20 | 3/4" |
| 25 | 1" |

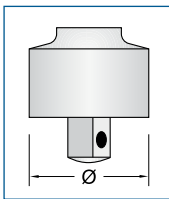
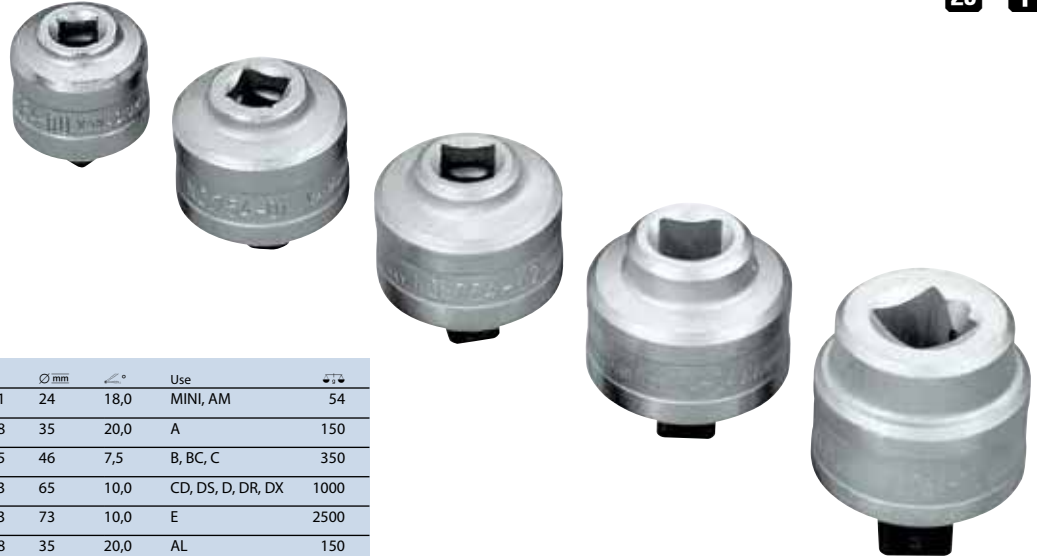

Code	No.	□"	■"	H	Ø mm	∠°	Use	↕
7680490	754-00	1/4	1/4	21	24	18,0	MINI, AM	54
7680570	754-01	3/8	3/8	28	35	20,0	A	150
7680650	754-02	1/2	1/2	35	46	7,5	B, BC, C	350
7680730	754-04	3/4	3/4	53	65	10,0	CD, DS, D, DR, DX	1000
7680810	754-06	1	1	63	73	10,0	E	2500
7686770	754-11	3/8	3/8	28	35	20,0	AL	150
7686850	754-12	1/2	1/2	35	46	7,5	BL, BCL, CL	350
7686930	754-14	3/4	3/4	53	65	10,0	CDL, DSL, DL, DRL, DXL	1000
7687150	754-16	1	1	63	73	10,0	EL	1800

EXTENSION TUBES FOR DREMOMETER DR - F + W

Use:

- Spare extension tube for torque wrench series DREMOMETER DR - F and DXZ
- To enable high torque values by means of extending the lever arm

Inclusion:

- Guarantees proof connection to the DREMOMETER
- Ideal for extending the lever arm
- Extension tubes 8572-74 / 8564-92 / 8564-40 made from high-grade, galvanised steel
- Extension tube 8571-80 made from high-grade aluminium with anodised locknuts - extremely lightweight
- Only for use with the DREMOMETER series!

Scope of delivery:

- Extension tube
- Single packed in poly-bag



Code	No.	Description	↳ mm ←	↕
7621640	8564-40	Extension tube for DREMOMETER E	400	2.3
7622020	8572-74	Extension tube for DREMOMETER E/F	745	3.6
1686313	8571-80	Extension tube ALU for DREMOMETER DX/DR	772	0.8
7621720	8564-92	Extension tube for DREMOMETER E/EK/F	925	3.4



Ratchet heads DREMOMETER 754

Ratchet head no. 754 can only be used in combination with the dremometer. Please note the right direction of rotation by the ratchet head when ordering. There are separate models for clockwise or counter-clockwise rotation. Ratchet head nos. 754-11 to -16 (counter-clockwise) can only be used with the dremometer with double square drive.



Torque angle indicator 8200

When using torque angle indicator no. 8200, please note: The maximum output of the torque wrenches must not be passed. Please ensure that the maximum load capacity of the square drive including the values achieved by angle-regulated tightening:

- 1/2" max. approx. 390 N·m
- 3/4" max. approx. 1330 N·m

is not exceeded.

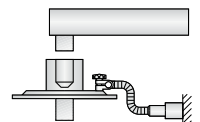



8200

TORQUE ANGLE INDICATOR

Use:

Additional angle-regulated tightening for controlled torque and angle activation

Inclusion:

- Torque angle indicator with 1/2" or 3/4" square drive
- For additional precise angle tightening (0-360°)
- 1/2" square drive with ball locking device or 3/4" square drive with pin locking device
- No. 8200-01/-02 models with sliding magnetic and gripping arm
- No. 8200-11 only with magnetic arm - simple design
- To operate with a suitable torque wrench
- The maximum output of the torque wrench must not be passed

Scope of delivery:

- Torque angle indicator
- Delivered in a strong plastic case (no. 8200-01/-02), model no. 8200-11 in sturdy hard cardboard packaging

12,5
1/2"
20
3/4"

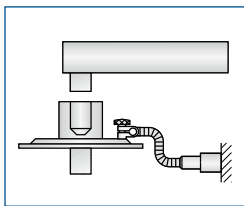

Code	No.	External <input checked="" type="checkbox"/> / Internal <input type="checkbox"/>	Ø mm	°	mm
1195980	8200-01	1/2" <input checked="" type="checkbox"/> / 1/2" <input type="checkbox"/>	80	0-360	330
7718480	8200-11	1/2" <input checked="" type="checkbox"/> / 1/2" <input type="checkbox"/>	82	0-360	330
7716510	8200-02	3/4" <input checked="" type="checkbox"/> / 3/4" <input type="checkbox"/>	120	0-360	530

8100 - 8116

TORQUE LIMIT UNIT 3/8"

Use:

Torque limiting for controlled screw tightening

Inclusion:

- 8116 - Sparking-plug socket with built-in torque limit unit
- 0774 - Adaptor 3/8" female square for ratchets with fixed head
- 8100 - Torque limiting adaptor for torque control with sparking-plug sockets. Fits with 3/8" female square drives
- All models of the torque limiting adaptors are available with a factory pre-set torque value in the range of 8-25 N-m

Scope of delivery:

- Torque limiting adaptor
- Single packed in poly-bag

10
3/8"
10
3/8"



Code	No.	External <input checked="" type="checkbox"/> / Internal <input type="checkbox"/>	Description	N-m	(-mm-)	mm
7717830	8116-18	3/8" <input checked="" type="checkbox"/> / 16 <input type="checkbox"/>	Spark plug with built-in torque control	18	83	200
7717910	8100-18	3/8" <input checked="" type="checkbox"/> / 3/8" <input type="checkbox"/>	Adaptor 3/8" for spark plug sockets	18	50	150
7717670	774-00	3/8" <input type="checkbox"/> / 3/8" <input type="checkbox"/>	Adaptor		25	30

920 922



487

923



487

3093 U-20

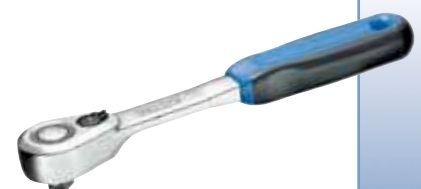

164



8460 Z - 8471 Z

TORQUE WRENCH DREMOMETER Z WITH QUICK-FITTING CHANGE 8-1000 N-m / 70 lbf-in - 730 lbf-ft

- ✔ Classified to DIN EN ISO 6789:2003 Type II Class A, with a factory certificate. Working accuracy: +/- 3% tolerance of scale set torque. The specification of the standard (+/- 4%) is exceeded.
- ✔ Lightweight yet robust (as the housing is made of an aluminium alloy) and resilient, very workshop-friendly
- ✔ Depending on the application, access is possible from the front (e.g. open-end fitting) or side (e.g. reversible ratchet and socket)
- ✔ Force to be applied in the middle of the handgrip only - do not use an extension tube as otherwise, inaccuracies can evolve (except for model DXZ where the DREMOMETER has been calibrated and adjusted using the extension tube)
- ✔ Operation only with end fittings with standardised depth gauges, otherwise inaccuracies can arise. Keep the depth gauges on the certificate in mind. Only use original GEDORE accessories.
- ✔ Large drive cross-section transfers maximum torques
- ✔ Extremely low wear attributable to reduced forces in the lever mechanism
- ✔ Forged lever chain from our own quality forge
- ✔ Maximum precision even when subjected to extreme continuous use
- ✔ Long life cycles and tool lives
- ✔ Easy operation - fast and safe torque tightening
- ✔ Easy adjustment thanks to attractive adjusting button secured against loss at the end of the handle
- ✔ With certificate acc. to DIN EN ISO 6789, traceable via in-house DKD laboratory to national standards

- 16
- 22
- 28

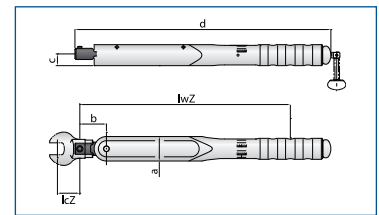
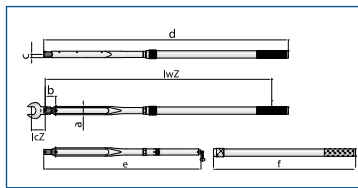
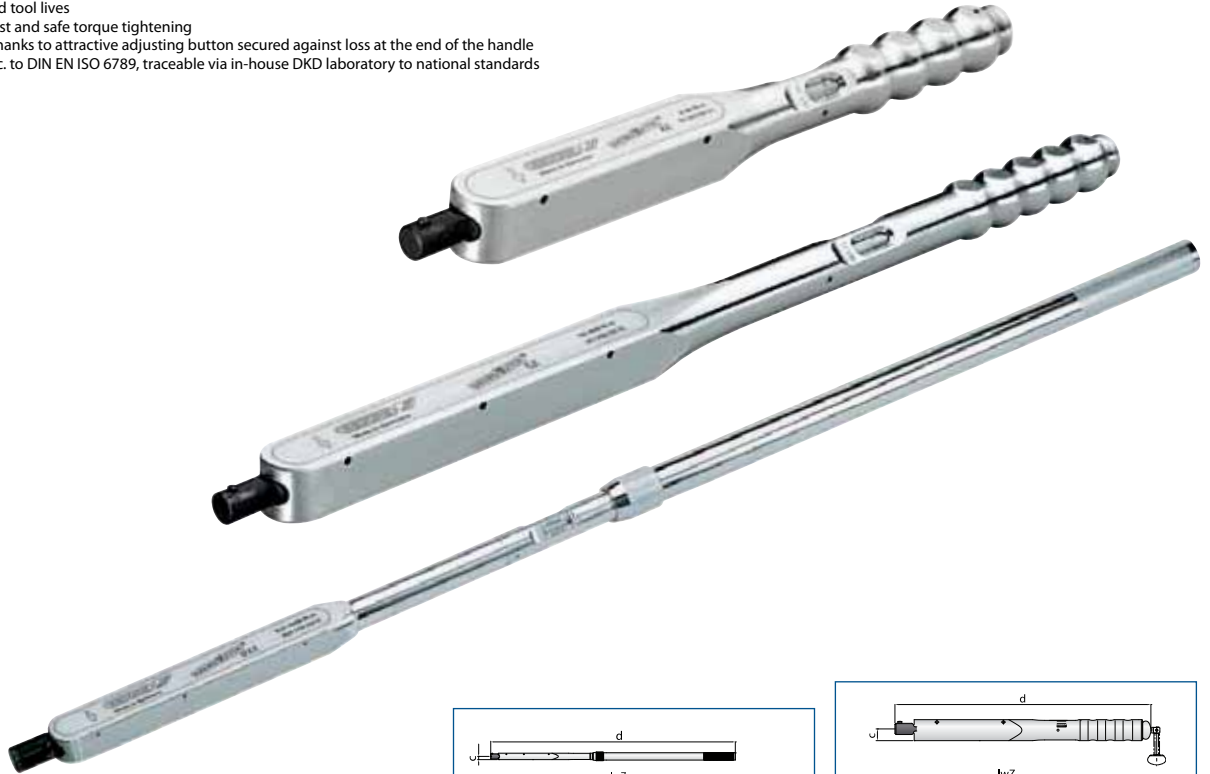

Code	No.	Type	Ø	N-m	lbf-in	lbf-ft	Accuracy	lwZ	lcZ	a	b	c	d	±
7703610	8460-01	AZ	16	8-40	70-350	-	5 N-m / 50 lbf-in	301	32	35	38	17	366	1000
7704260	8461-01	BZ	16	20-120	-	15-90	5 N-m / 5 lbf-ft	412	32	35	38	17	490	1450
7704340	8462-01	CZ	16	50-400	-	35-300	5 N-m / 5 lbf-ft	567	32	35	38	17	645	2000
7703020	8463-10	DZ	22	140-620	-	105-450	10 N-m / 10 lbf-ft	768	56	45	49	18	846	3000
1251341	8471-01	DXZ	28	520-1000	-	380-730	10 N-m / 10 lbf-ft	1231	75	45	57	18	1329	5500



Technical information Z

- ✔ The large cross-section of the spigot end transfers a maximum torque. "Quick-fitting-change-system" with a locking pin mechanism guarantees that work takes place flexibly and rapidly.
- ✔ Ideal for bolted connections in cramped and hard-to-access locations. Depending on how the DREMOMETER Z is used, it is possible to work both in the forward direction and also to the side.



**OUR SERVICE –
qualified and customised**



DKD



**280
-
287**



7460 - 7471



249



8791 - 8798

- 16
- 22
- 28



**264
-
267**



8480 SE - 8482 SE

TORQUE WRENCH DREMOMETER SE WITH QUICK-FITTING CHANGE 8-400 N-m / 70 lbf-in - 300 lbf-ft

- Classified to DIN EN ISO 6789:2003 Type II Class A, with a factory certificate. Working accuracy: +/- 3% tolerance of scale set torque. The specification of the standard (+/- 4%) is exceeded.
- Lightweight yet robust (as the housing is made of an aluminium alloy) and resilient, very workshop-friendly
- Drive offers extensive range of accessories
- Depending on the application, access is possible from the front (e.g. rectangular open-end fitting) or side (e.g. reversible ratchet and socket)
- Force to be applied in the middle of the handgrip only - do not use an extension tube as otherwise, inaccuracies can arise
- Operation only with end fittings otherwise inaccuracies can arise. Keep the depth gauges on the certificate in mind. Only use original GEDORE accessories.
- Extremely low wear attributable to reduced forces in the lever mechanism
- Forged lever chain from our own quality forge
- Maximum precision even when subjected to extreme continuous use
- Long life cycles and tool lives
- Easy operation - fast and safe torque tightening
- Easy adjustment thanks to attractive adjusting button secured against loss at the end of the handle
- With certificate acc. to DIN EN ISO 6789, traceable via in-house DKD laboratory to national standards

9x12
14x18

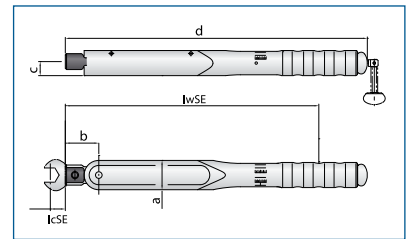
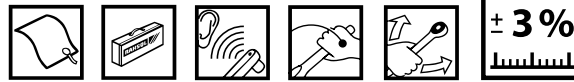
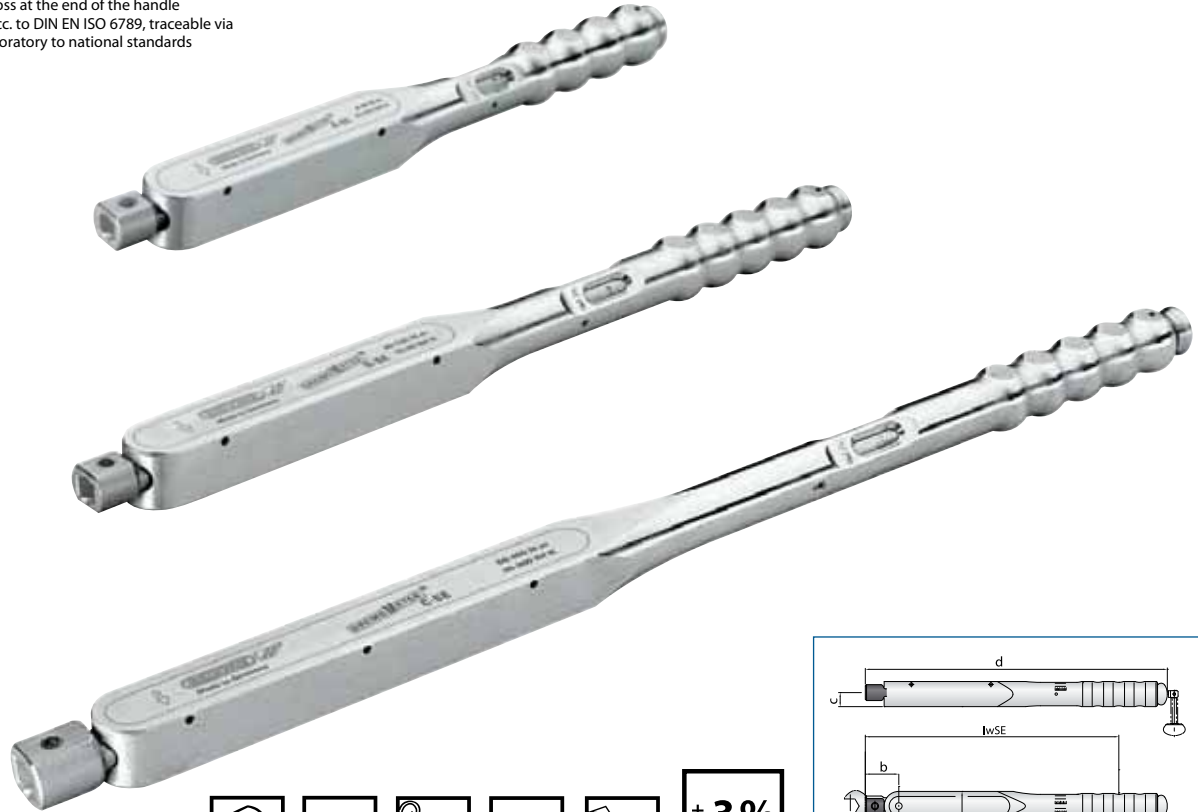

Code	No.	Type	□mm	N-m	lbf-in	lbf-ft	مقاس	lwSE	lcSE	a	b	c	d	±%
7714060	8480-01	A-SE	9 x 12	8-40	70-350	-	5 N-m / 50 lbf-in	303	17.5	35	40	17	361	950
7714140	8481-01	B-SE	9 x 12	20-120	-	15-90	5 N-m / 5 lbf-ft	414	17.5	35	40	17	485	1250
7714220	8482-01	C-SE	14 x 18	50-400	-	35-300	5 N-m / 5 lbf-ft	579	25.0	35	50	17	649	1700



Technical information - Quick-fitting change

Quick-fitting tool change system with pin locking guarantees flexible and swift working methods. Ideal for installations in confined and poorly accessible spaces. Depending on the application for the **Dremometer SE**, access is possible from the front and side.

www.gedore.com

7480 - 7482



249

7112 - 7918



268
269



7554 AM - 7572 F

TORQUE WRENCH DREMOMETER A+S

Technical advantage/function:

- ✔ Classified to DIN EN ISO 6789:2003 Type II Class A, with a factory certificate. Working accuracy: +/- 3% tolerance of scale set torque. The specification of the standard (+/- 4%) is exceeded.
- ✔ Lightweight and robust (as housing is made of an aluminium alloy), very workshop-friendly
- ✔ No inaccuracies whether used with both hands or held away from the handle (as for standard torque wrenches) Both the square drive and fulcrum are on an axis which ensures a high degree of user safety; can be extended to reduce the user's working load.
- ✔ Extremely low wear attributable to reduced forces in a unique lever mechanism
- ✔ Forged lever chain from our own quality forge
- ✔ Maximum precision even when subjected to extreme continuous use
- ✔ Long life cycles and tool lives
- ✔ Easy operation - fast and safe torque tightening
- ✔ Easy adjustment thanks to attractive adjusting button secured against loss at the end of the handle
- ✔ Single- and double-square drive for controlled bi-directional tightening
- ✔ **Pre-set value locking and safety device (A+S) eliminates the possibility of unintentional or manipulated adjustment**, thereby representing more process reliability of the user

Use:

- ✔ Controlled screw tightening in the range 6 - 3000 N-m
- ✔ For use in almost all industrial manufacturing areas
- ✔ **Pre-set DREMOMETER for serial production wherever the same value always needs to be applied**

Features:

- ✔ With certificate acc. to DIN EN ISO 6789, traceable via in-house DKD laboratory to national standards
- ✔ Automatic short-path actuation with tactile impulse and audible signal
- ✔ Dual scale with corresponding scale graduation (see table)
- ✔ Type B, BC, C with push-button release



- 6,3 1/4"
- 10 3/8"
- 12,5 1/2"
- 20 3/4"
- 25 1"
- 40 1 1/2"

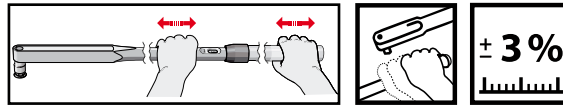
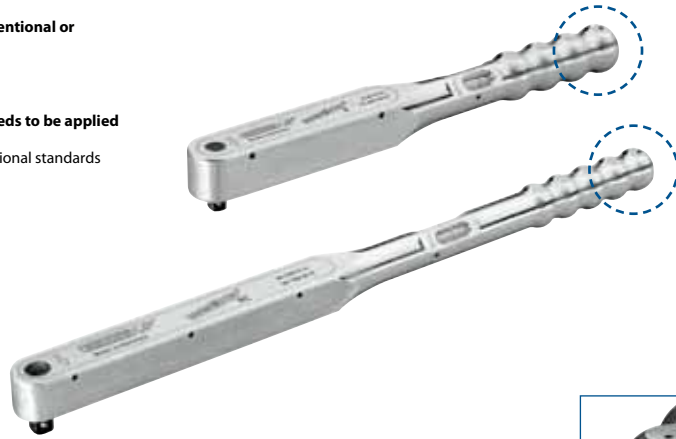

Code	No.	Icon	Type	■*	■	N-m	lbf-in	lbf-ft	Icon	lw	a	b	c	d	e	f	↕
1210891	7554-01	☐	AM A+S	1/4	6.3	6-30	50-270	-	1 N-m / 10 lbf-in	207	30	15.0	268	-	-	-	580
1210904	7559-01	☐	AML A+S	1/4	6.3	6-30	50-270	-	1 N-m / 10 lbf-in	207	30	15.0	268	-	-	-	580
7708920	7560-01	☐	A A+S	3/8	10.0	8-40	70-350	-	5 N-m / 50 lbf-in	263	30	17.5	338	-	-	-	1000
1210939	7565-01	☐	AL A+S	3/8	10.0	8-40	70-350	-	5 N-m / 50 lbf-in	263	30	17.5	338	-	-	-	1000
7709060	7561-01	☐	B A+S	1/2	12.5	20-120	-	15-90	5 N-m / 5 lbf-ft	374	30	17.5	462	-	-	-	1500
1210947	7566-01	☐	BL A+S	1/2	12.5	20-120	-	15-90	5 N-m / 5 lbf-ft	374	30	17.5	462	-	-	-	1500
1211013	7573-00	☐	BC A+S	1/2	12.5	40-200	-	30-150	5 N-m / 5 lbf-ft	463	30	17.5	551	-	-	-	1400
1427113	7578-00	☐	BCL A+S	1/2	12.5	40-200	-	30-150	5 N-m / 5 lbf-ft	463	30	17.5	551	-	-	-	1300
7709650	7562-10	☐	C A+S	1/2	12.5	50-300	-	35-220	5 N-m / 5 lbf-ft	529	30	17.5	617	-	-	-	2000
1210955	7567-10	☐	CL A+S	1/2	12.5	50-300	-	35-220	5 N-m / 5 lbf-ft	529	30	17.5	617	-	-	-	2000
1210998	7570-10	☐	CD A+S	3/4	20.0	80-360	-	60-260	5 N-m / 5 lbf-ft	624	30	22.5	717	-	-	-	2400
1211021	7575-10	☐	CDL A+S	3/4	20.0	80-360	-	60-260	5 N-m / 5 lbf-ft	624	30	22.5	717	-	-	-	2400
1427164	7574-10	☐	DS A+S	3/4	20.0	110-550	-	80-400	10 N-m / 10 lbf-ft	719	35	22.5	812	-	-	-	2900
1427148	7579-10	☐	DSL A+S	3/4	20.0	110-550	-	80-400	10 N-m / 10 lbf-ft	719	35	22.5	812	-	-	-	2900
1210921	7563-10	☐	D A+S	3/4	20.0	140-760	-	100-560	10 N-m / 10 lbf-ft	719	35	22.5	812	-	-	-	3200
1210971	7568-10	☐	DL A+S	3/4	20.0	140-760	-	100-560	10 N-m / 10 lbf-ft	719	35	22.5	812	-	-	-	3200
1210912	7563-01	☐	DR A+S	3/4	20.0	140-760	-	100-560	10 N-m / 10 lbf-ft	1297	35	22.5	812	1413	772	-	5000
1210963	7568-01	☐	DRL A+S	3/4	20.0	140-760	-	100-560	10 N-m / 10 lbf-ft	1297	35	22.5	812	1413	772	-	5000
1211005	7571-01	☐	DX A+S	3/4	20.0	520-1000	-	380-730	10 N-m / 10 lbf-ft	1297	35	22.5	812	1413	772	-	5600
1211048	7576-01	☐	DXL A+S	3/4	20.0	520-1000	-	380-730	10 N-m / 10 lbf-ft	1297	35	22.5	812	1413	772	-	5600
2311321	7581-01	☐	EK A+S	1	25.0	600-1500	-	-	50 N-m	1873	40	30.0	932	1608	925	-	10800
2311348	7586-01	☐	EKL A+S	1	25.0	600-1500	-	-	50 N-m	1873	40	30.0	932	1608	925	-	10800
1547232	7564-01	☐	E A+S	1	25.0	750-2000	-	-	50 N-m	1873	40	30.0	932	2353	772	745	11600
1547240	7569-01	☐	EL A+S	1	25.0	750-2000	-	-	50 N-m	1873	40	30.0	932	2353	772	745	11600
1547259	7572-01	☐	F A+S	1.1/2	40.0	1500-3000	-	-	50 N-m	2313	40	35.0	1025	2453	772	745	13200

Our service - qualified and customised

DKD

280 - 287

754

244



7460 Z - 7471 Z

TORQUE WRENCH DREMOMETER Z A+S



Code	No.	Type	Ø	N-m	lbf-in	lbf-ft	مستطيل	lwZ	lcZ	a	b	c	d	طول
1427067	7460-01	AZ A+S	16	8-40	70-350	-	5 N-m / 50 lbf-in	301	32	35	38	17	366	1000
1427075	7461-01	BZ A+S	16	20-120	-	15-90	5 N-m / 5 lbf-ft	412	32	35	38	17	490	1450
1225669	7462-01	CZ A+S	16	50-400	-	35-300	5 N-m / 5 lbf-ft	567	32	35	38	17	645	2000
1427083	7463-10	DZ A+S	22	140-620	-	105-450	10 N-m / 10 lbf-ft	768	56	45	49	18	846	3000
1521977	7471-01	DXZ A+S	28	520-1000	-	380-730	10 N-m / 10 lbf-ft	1231	75	45	57	18	1329	5500

7480 SE - 7482 SE

TORQUE WRENCH DREMOMETER SE A+S

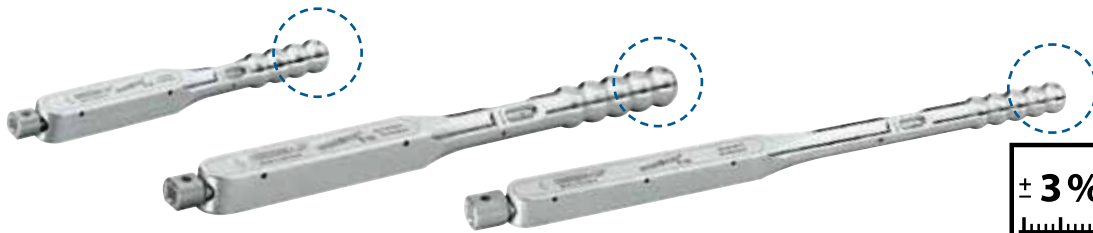

Code	No.	Type	□mm	N-m	lbf-in	lbf-ft	مستطيل	lwSE	lcSE	a	b	c	d	طول
1427059	7480-01	A-SE A+S	9 x 12	8-40	70-350	-	5 N-m / 50 lbf-in	303	17.5	35	40	17	361	950
1427091	7481-01	B-SE A+S	9 x 12	20-120	-	15-90	5 N-m / 5 lbf-ft	414	17.5	35	40	17	485	1250
1427105	7482-01	C-SE A+S	14 x 18	50-400	-	35-300	5 N-m / 5 lbf-ft	579	25.0	35	50	17	649	1700



DREMOMETER TYP D

++



DREMOMETER TYP C



++++



DREMOMETER TYP BC



++

DREMOMETER TYP DR





TORCOFIX K

ROBUST TORQUE WRENCH WITH SQUARE DRIVE AND INTEGRATED RATCHET-HEAD FUNCTION FOR CONTROLLED BI-DIRECTIONAL TIGHTENING.



Working accuracy: +/- 3% tolerance of scale set torque. Includes test certificate according to DIN EN ISO 6789. Serial number on the wrench and on the certificate for unambiguous product identification, traceable to national standards.



Robust steel tube: With high corrosion protection, chrome-plated, silk-metal.



Chrome-plated ratchet head: All 1/4" - 1/2" square drives of the TOROFIX K-series have a black plastic cap - also referred to as a mushroom head. This mushroom head prevents an unintentional pulling out of the whole square drive when changing the nut socket.



MECHANICS

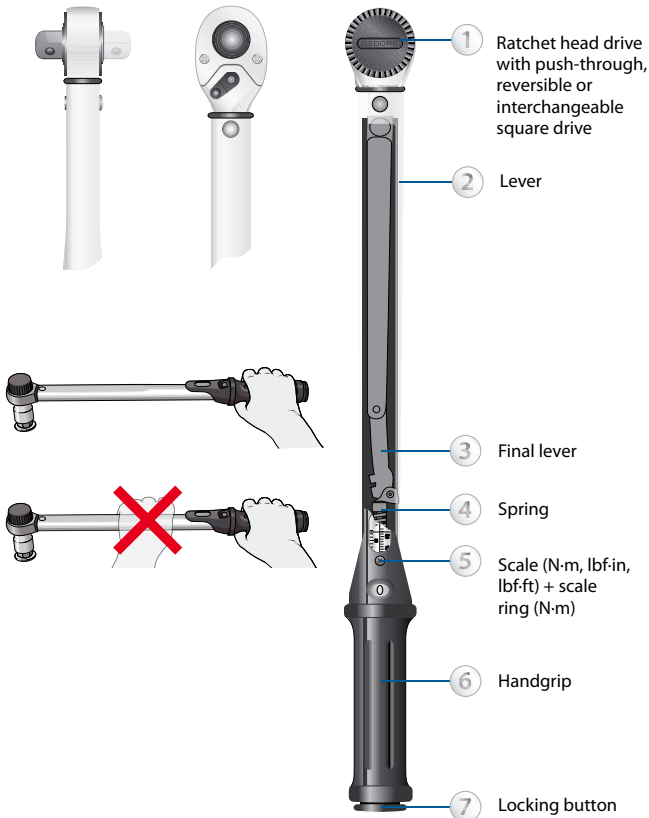

FEATURES

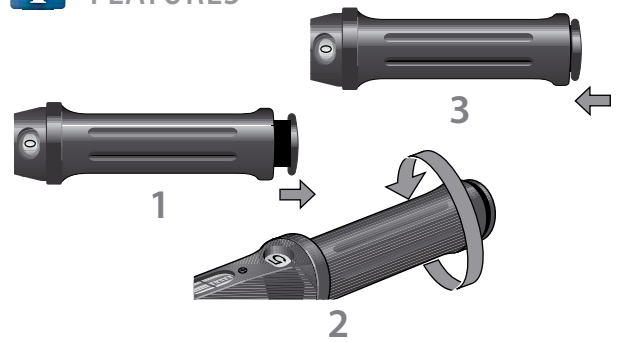

Pull out the locking button at the end of the handgrip and turn the handgrip in the clockwise or counter-clockwise direction in order to make the desired torque setting. Lock the locking button again. Finished!

FUNCTION

In order to change the turning direction of the TORCOFIX K:

Press on the protruding square drive with your thumb and take out the mushroom head, turn the wrench and re-insert the square drive.

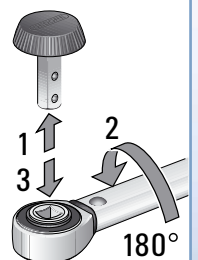



Micrometer scale: Optimised shape, stable scale frame with red-shaded micrometer scale ring. Model-independent intervals of 1; 0,5; 0,25; 0,1 or 0,025 N-m allow very accurate settings.

Lighweight and reliable: Locking button enables reliable locking of the torque setting.

Automatic actuation: The TORCOFIX actuates with a clear tactile impulse and audible signal and is immediately ready for operation again.

Scale: Easily readable dual scale (N-m / lbf-in / lbf-ft) well protected under a window with a magnifying-glass effect. The torque setting is readable on the scale or, more particularly, on the scale in combination with the scale ring.



Handgrip with user aid: Black plastic handgrip, new ergonomically enhanced shape, with an indentation in the middle of the handgrip. User aid and reference points for calibration.

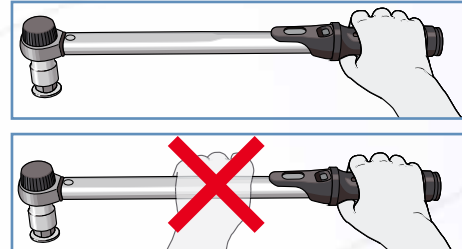

TORCOFIX UK ++ TORQUE WRENCH WITH PUSH-THROUGH SQUARE DRIVE AND INTEGRATED RATCHET-FUNCTION FOR CONTROLLED CLOCKWISE TIGHTENING



for controlled clockwise tightening

1/2" square drive and integrated lever-change reversible ratchet function

i OPERATION

For the TORCOFIX UK: Switch the lever of the reversible ratchet to correspond with the desired direction, clockwise or counter-clockwise.

++

K $\frac{1}{2}$ - $\frac{3}{4}$
1-850 N-m



++

K US $\frac{1}{2}$ - $\frac{3}{4}$
10 lbf-in - 600 lbf-ft



+

UK $\frac{1}{2}$
10-300 N-m



++

Z $\oplus \ominus$
2-850 N-m



+

SE $\frac{9}{16}$ $\frac{13}{16}$
2-400 N-m





4549 - 6551

TORQUE WRENCH TORCOFIX K / UK / K US 1-850 N-m / 10 lbf-in - 630 lbf-ft

Use:

- Controlled screw tightening in the most widely used range of 1 - 850 N-m / 10 lbf-in - 630 lbf-ft
- For use in almost all industrial manufacturing areas

Features:

- Classified to DIN EN ISO 6789:2003 Type II Class A, with a factory certificate. Working accuracy: +/- 3% tolerance of scale set torque. The specification of the standard (+/- 4%) is exceeded.
- Adjustable torque wrench with square drive and integrated ratchet function
- For controlled bi-directional tightening (type K, US), type UK (5550) only for controlled clockwise tightening
- 1/4", 3/8", 1/2" interchangeable mushroom head with ball locking device as per DIN 3120 - A 6.3, A 10 or A 12.5, similar to ISO 1174
- With 3/4" push-through square drive with pin-locking mechanism (from model no. 4550-40)
- With certificate acc. to DIN EN ISO 6789, traceable via in-house DKD laboratory to national standards
- Release system triggers a tactile and audible signal
- Sturdy, satin chrome-plated tubular steel design, with chrome-plated ratchet head and high-quality plastic parts
- Dual scale N-m and lbf-in / lbf-ft below a window with a magnifying glass effect
- Magnifying glass with marking for minimum paralaxe errors allows a high degree of safety when setting the requisite torque value
- Additional micrometre scale for setting interim values
- Ergonomically shaped, convenient black plastic handgrip
- With an indentation in the middle of the handgrip as a calibration aid
- TORCOFIX K US (6550 - 6551) - version for Angloamerican units

- 6.3 1/4"
- 10 3/8"
- 12.5 1/2"
- 20 3/4"

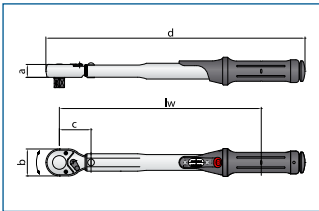
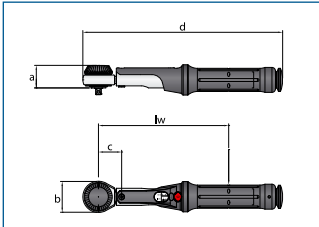

Code	No.	■"	■	N-m	lbf-ft	سلسل	scale ring	lw	a	b	c	d	↕↔
2201429	4549-00	1/4	6.3	1-5	0,75-3,7	0,25 N-m	0,025 N-m	146.0	25.3	35	26	224.0	323
1545132	4549-02	1/4	6.3	2-25	1,5-18	1 N-m	0,1 N-m	206.5	24.0	35	26	284.5	450
1545140	4549-05	3/8	10.0	5-50	3,5-37	2,5 N-m	0,25 N-m	256.5	24.0	35	26	334.5	540
7601530	4550-10	1/2	12.5	10-100	8-75	5 N-m	0,5 N-m	303.5	33.0	44	35	394.0	900
7601610	4550-20	1/2	12.5	20-200	15-150	10 N-m	1 N-m	394.5	33.0	44	35	485.0	1100
7601880	4550-30	1/2	12.5	60-300	45-220	10 N-m	1 N-m	485.5	33.0	46	35	577.0	1400
7674330	4550-40	3/4	20.0	75-400	55-300	10 N-m	1 N-m	572.5	31.0	69	52	686.0	2000
7674760	4550-55	3/4	20.0	100-550	75-405	10 N-m	1 N-m	853.0	31.0	69	52	956.5	3800
1521365	4550-75	3/4	20.0	140-750	105-550	10 N-m	1 N-m	1,133.0	31.0	69	327	1,236.0	4800
1950525	4551-85	3/4	20.0	250-850	185-630	10 N-m	1 N-m	1,276.0	31.0	69	1276	1,379.0	4700

Code	No.	■"	■	N-m	lbf-ft	سلسل	scale ring	lw	a	b	c	d	↕↔
1210467	5550-10	1/2	12.5	10-100	8-75	5 N-m	0,5 N-m	318.2	22.0	43	50	409.0	1000
1210475	5550-20	1/2	12.5	20-200	15-150	10 N-m	1 N-m	409.2	22.0	43	50	500.0	1200
1210483	5550-30	1/2	12.5	60-300	45-220	10 N-m	1 N-m	500.2	22.0	43	50	591.0	1400

Code	No.	■"	■	N-m	lbf-in	lbf-ft	سلسل	scale ring	lw	a	b	c	d	↕↔
1956744	6550-01	1/4	6.3	1,1-5,6	10-50		2,5 lbf-in	0,25 lbf-in	140.0	24.0	35	26	220.0	300
1956752	6550-02	1/4	6.3	2-11	20-100		5 lbf-in	0,5 lbf-in	140.0	24.0	35	26	220.0	300
1956779	6550-05	3/8	10.0	6-28	50-250		10 lbf-in	1 lbf-in	230.0	33.0	43	35	307.0	800
1956787	6550-15	3/8	10.0	17-113	150-1000		50 lbf-in	5 lbf-in	303.5	33.0	44	35	394.0	900
1956795	6551-07	3/8	10.0	10-68		7-50	2,5 lbf-ft	0,25 lbf-ft	303.5	33.0	44	35	394.0	900
1956817	6551-10	1/2	12.5	15-102		10-75	2,5 lbf-ft	0,25 lbf-ft	303.5	33.0	44	35	394.0	900
1956833	6551-30	1/2	12.5	40-205		30-150	5 lbf-ft	0,5 lbf-ft	394.5	33.0	44	35	485.0	1100
1956841	6551-60	3/4	20.0	81-407		60-300	10 lbf-ft	1 lbf-ft	572.5	31.0	69	52	686.0	2000
1956868	6551-120	3/4	20.0	163-810		120-600	10 lbf-ft	1 lbf-ft	1,133.0	31.0	69	327	1,236.0	4500



4549-G - 4550-G

TORQUE WRENCH SET TORCOFIX K 1-400 N-m / 0.75-300 lbf-ft

- ▶ The TORCOFIX K as a practical tool set
- ▶ Most-widely-used tools in a robust sheet-metal case
- ▶ Clearly organised - everything always ready to hand
- ▶ With foam-material inlay modules (on request, these can be customised or extended individually)

- 6,3 1/4"
- 10 3/8"
- 12,5 1/2"

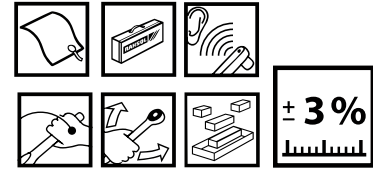

Code	No.	□"	■	Contents	N-m	lbf-ft	Accuracy	Weight
2312646	4549-G00	1/4	6.3	≡ No. 4549-00 - in sheet-metal case ○ 7 8 10 13 ← 55 mm and 1/4" square drive	1-5	0,75-3,7	0,25 N-m	3.0
1547003	4549-G02	1/4	6.3	≡ No. 4549-02 - in sheet-metal case ○ 7 8 10 13 ← 55 mm and 1/4" square drive	2-25	1,5-18	1 N-m	3.2
1547011	4549-G05	3/8	10.0	≡ No. 4549-05 - in sheet-metal case ○ 8 10 13 17 ← 125 mm and 3/8" square drive	5-50	3,5-37	2,5 N-m	3.5
1547038	4550-G10	1/2	12.5	≡ No. 4550-10 - in sheet-metal case ○ 10 13 17 19 24 ← 125 mm and 1/2" square drive	10-100	8-75	5 N-m	4.3
1547046	4550-G20	1/2	12.5	≡ No. 4550-20 - in sheet-metal case ○ 10 13 17 19 24 ← 125 mm and 1/2" square drive	20-200	15-150	10 N-m	5.5
1547062	4550-G30	1/2	12.5	≡ No. 4550-30 - in sheet-metal case ○ 17 19 24 27 ← 125 mm and 1/2" square drive	60-300	45-220	10 N-m	5.6
1547070	4550-G40	3/4	20.0	≡ No. 4550-40 - in sheet-metal case ○ 18 19 24 27 ← 200 mm and 3/4" square drive	75-400	55-300	10 N-m	6.0

4550

QUICK-TURN WITH T-GRIP DREH-FIX TORCOFIX K

- Use:**
- ▶ For TORCOFIX 4550
 - ▶ Enables controlled torque tightening in combination with a TORCOFIX K
 - ▶ Very quick pre-tightening, following the torque wrench makes the final work

- Inclusion:**
- ▶ Made of chrome-vanadium steel
 - ▶ With T-grip made of polypropylene (PPN)
 - ▶ Scarred grip
 - ▶ With 3/8" or 1/2" square drive with ball locking device
 - ▶ 4550-80 1/2" = 340 N-m
 - ▶ 4550-81 3/8" = 135 N-m

- Scope of delivery:**
- ▶ Quick-Turn
 - ▶ Single packed in poly-bag

- 10
- 3/8"
- 12,5
- 1/2"

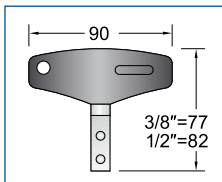

Code	No.	□"	□	■	■	Weight
7604390	4550-80	1/2	12.5	1/2	12.5	100
7604470	4550-81	1/2	12.5	3/8	10.0	100

4549 - 4550

MUSHROOM HEAD / SQUARE DRIVE TORCOFIX K

- Use:**
- ▶ Interchangeable square drive (mushroom head) for TORCOFIX K
- Features:**
- ▶ Made of chrome-vanadium steel, zinc-plated
 - ▶ With black mushroom head made of polypropylene (PPN)
 - ▶ With 1/4", 3/8" or 1/2" output square drive with ball locking device
- Scope of delivery:**
- ▶ Square drive (mushroom head)
 - ▶ Single packed in poly-bag

- 6,3
- 1/4"
- 10
- 3/8"
- 12,5
- 1/2"



Code	No.	Description	□"	□	■	■	Ø mm	Weight
1545167	4549-875	Mushroom head 3/8-1/4"	3/8	10.0	1/4	6.3	35	21
1566385	4549-885	Mushroom head 3/8"	3/8	10.0	3/8	10.0	35	22
7079370	4550-855	Mushroom head 1/2"	1/2	12.5	1/2	12.5	44	60
7079450	4550-865	Mushroom head 1/2-3/8"	1/2	12.0	3/8	10.0	44	60
6279090	3294	Coupler 3/4"	3/4	20.0	3/4	20.0		133

➔ **8612-300**

277

➔ **DKD**

280 - 287

➔ **279**

279



TORCOFIX Z

4400 - 4475

TORQUE WRENCH TORCOFIX Z 2-850 N-m / 1,5-630 lbf-ft

Use:

- Controlled screw tightening in the most widely used range of 2 - 750 N-m / 1.5 - 550 lbf-ft
- For use in almost all industrial manufacturing areas

Features:

- Classified to DIN EN ISO 6789:2003 Type II Class A, with a factory certificate. Working accuracy: +/- 3% tolerance of scale set torque. The specification of the standard (+/- 4%) is exceeded.
- Adjustable torque wrench with spigot end
- For controlled bi-directional tightening
- With certificate acc. to DIN EN ISO 6789, traceable via in-house DKD laboratory to national standards
- Release system triggers a tactile and audible signal
- Sturdy, satin chrome-plated tubular steel design and high-quality plastic parts
- Dual scale N-m and lbf-ft below a window with a magnifying-glass effect
- Magnifying glass with marking for minimum paralaxe errors allows a high degree of safety when setting the requisite torque value
- Additional micrometre scale for setting interim values
- Ergonomically shaped black plastic handgrip
- With an indentation in the middle of the handgrip as a calibration aid
- Factory depth gauges: 32 mm (16) or 56 mm (22)
- Operation only with end fittings with standardised depth gauges, otherwise inaccuracies can arise
- Depending on the application, access is possible from the front (e.g. open-end fitting) or side (e.g. reversible ratchet and socket)

16

22



Code	No.	Ø	N-m	lbf-ft	scale ring	lwZ	lcZ	a	b	c	↕	
1646168	4400-02	16	2-25	1,5-18	1 N-m	0,1 N-m	211.0	32	20.0	30	279.0	330
1646176	4405-05	16	5-50	3,5-37	2,5 N-m	0,25 N-m	261.0	32	20.0	30	329.0	390
7097270	4410-01	16	10-100	8-75	5 N-m	0,5 N-m	300.5	32	27.5	32	376.5	700
7097350	4420-01	16	20-200	15-150	10 N-m	1 N-m	391.5	32	27.5	32	467.5	860
7097430	4430-01	16	60-300	45-220	10 N-m	1 N-m	482.5	32	27.5	32	558.5	1080
7094090	4440-01	16	75-400	55-300	10 N-m	1 N-m	569.5	32	35.0	32	645.5	1390
7501310	4450-01	22	100-550	75-400	10 N-m	1 N-m	843.0	56	36.6	37	921.0	3000
1521381	4475-01	22	140-750	105-550	10 N-m	1 N-m	1,124.0	56	38.0	318	1,202.0	4060
1997009	4485-01	22	250-850	185-630	10 N-m	1 N-m	1,267.0	56	38.0	465	1,345.0	4430



Technical information Z

- The large cross-section of the spigot end transfers a maximum torque. "Quick-fitting-change-system" with a locking pin mechanism guarantees that work takes place flexibly and rapidly.
- Ideal for bolted connections in cramped and hard-to-access locations. Depending on how the DREMOMETER Z is used, it is possible to work both in the forward direction and also to the side.

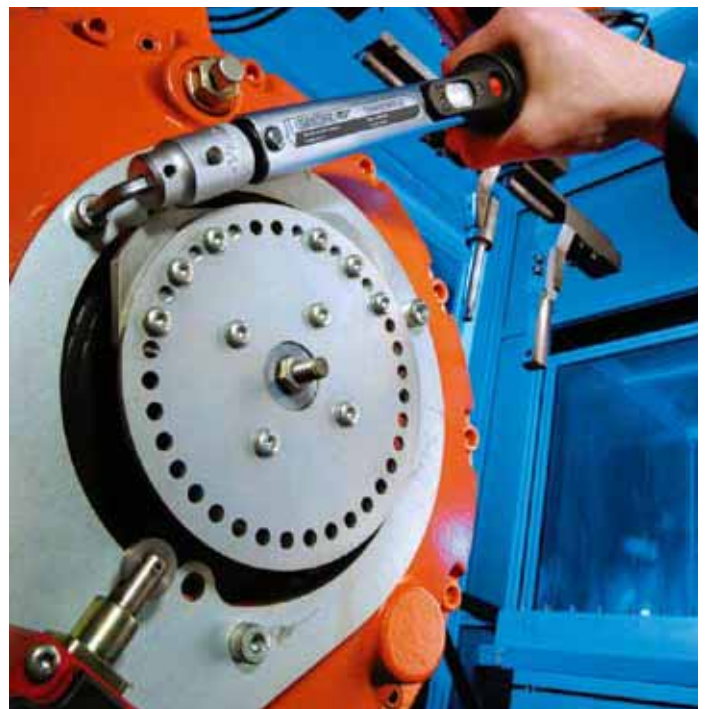

- On request, all torque wrenches can be factory pre-set.
- When ordering, please specify the N-m value.



4400-G - 4440-G

TORQUE WRENCH SET TORCOFIX Z 2-400 N-m / 1,5-300 lbf-ft

- ▶ The TORCOFIX Z as a practical tool set
- ▶ Most-widely-used tools in a robust sheet-metal case
- ▶ Clearly organised - everything always ready to hand
- ▶ With foam-material inlay modules (on request, these can be customised or extended individually)

16

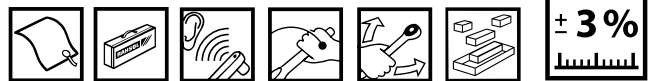

Code	No.	Ø	Contents	N-m	lbf-ft	المقدار	حجم
1663259	4400-G02	16	No. 4400-02 - in sheet-metal case 10 13 17 10 13 17 and ratchet head	2-25	1,5-18	1 N-m	3.0
1663267	4405-G05	16	No. 4405-05 - in sheet-metal case 10 13 17 10 13 17 and ratchet head	5-50	3,5-37	2,5 N-m	3.3
1547186	4410-G01	16	No. 4410-01 - in sheet-metal case 17 19 24 17 19 24 and ratchet head	10-100	8-75	5 N-m	4.3
1547194	4420-G01	16	No. 4420-01 - in sheet-metal case 17 19 24 17 19 24 and ratchet head	20-200	15-150	10 N-m	5.6
1547208	4430-G01	16	No. 4430-01 - in sheet-metal case 24 27 30 32 24 27 and ratchet head	60-300	45-220	10 N-m	6.3
1547216	4440-G01	16	No. 4440-01 - in sheet-metal case 24 27 30 32 24 27 and ratchet head	75-400	55-300	10 N-m	6.6



8791 - 8797

264 - 267

16

1220-00

279

8600 - 8660

272 - 275



TORCOFIX SE

4100 - 4301

TORQUE WRENCH TORCOFIX SE 2-400 N-m / 1.5-300 lbf-ft

Use:

- Controlled screw tightening in the most widely used range of 2 - 400 N-m / 1.5 - 300 lbf-ft
- For use in almost all industrial manufacturing areas

Features:

- Classified to DIN EN ISO 6789:2003 Type II Class A, with a factory certificate. Working accuracy: +/- 3% tolerance of scale set torque. The specification of the standard (+/- 4%) is exceeded.
- Adjustable torque wrench with rectangular cavity
- For controlled bi-directional tightening
- With certificate acc. to DIN EN ISO 6789, traceable via in-house DKD laboratory to national standards
- Release system triggers a tactile and audible signal
- Sturdy, satin chrome-plated tubular steel design and high-quality plastic parts
- Dual scale N-m and lbf-ft below a window with a magnifying glass effect. Magnifying glass with marking for minimum paralaxe errors allows a high degree of safety when setting the requisite torque value
- Additional micrometre scale for setting interim values
- Ergonomically shaped, convenient black plastic handgrip
- With an indentation in the middle of the handgrip as a calibration aid
- Factory depth gauges: 17.5 mm (9x12) or 25 mm (14x18)
- Operation only with end fittings with standardised depth gauges, otherwise inaccuracies can arise
- Depending on the application, access is possible from the front (e.g. rectangular open-end fitting) or side (e.g. reversible ratchet and socket)

9x12

14x18



Code	No.	mm	N-m	lbf-ft	lbf-in	scale ring	lwSE	lcSE	a	b	c	STW
1646192	4101-02	9 x 12	2-25	1,5-18	1 N-m	0,1 N-m	213.0	17.5	20.0	32	274.0	300
1646206	4101-05	9 x 12	5-50	3,5-37	2,5 N-m	0,25 N-m	263.0	17.5	20.0	32	324.0	450
7600210	4100-01	9 x 12	10-100	8-75	5 N-m	0,5 N-m	300.5	17.5	27.5	32	369.5	600
1654934	4200-02	9 x 12	20-150	15-110	10 N-m	1 N-m	391.5	17.5	27.5	32	460.5	800
7600990	4201-01	14 x 18	20-200	15-150	10 N-m	1 N-m	401.5	25.0	27.5	42	470.5	900
7601020	4300-01	14 x 18	60-300	45-220	10 N-m	1 N-m	492.5	25.0	27.5	42	561.5	1200
7604120	4301-01	14 x 18	75-400	55-300	10 N-m	1 N-m	579.5	25.0	35.0	42	648.5	1600

DKD

286 - 287

8612-300

277

1220-00

279

i

- On request, all torque wrenches can be factory pre-set.
- When ordering, please specify the N-m value.

7112 - 7918

268 - 269

8600

272



4100-G - 4301-G

TORQUE WRENCH SET TORCOFIX SE 2-400 N-m / 1.5-300 lbf-ft

- ▶ The TORCOFIX SE as a practical tool set
- ▶ Most-widely-used tools in a robust sheet-metal case
- ▶ Clearly organised - everything always ready to hand
- ▶ With foam-material inlay modules (on request, these can be customised or extended individually)

9x12

14x18

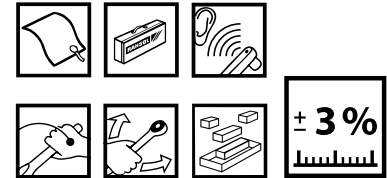

Code	No.	□mm	Contents	N-m	lbf-ft	mm	mm
1663224	4101-G02	9 x 12	No. 4101-02 - in a sheet-metal case 10 13 17 10 13 17 and -ratchet head	2-25	1,5-18	1 N-m	3.0
1663232	4101-G05	9 x 12	No. 4101-05 - in a sheet-metal case 10 13 17 10 13 17 and -ratchet head	5-50	3,5-37	2,5 N-m	3.3
1547100	4100-G01	9 x 12	No. 4100-01 - in a sheet-metal case 13 17 19 13 17 19 and -ratchet head	10-100	8-75	5 N-m	3.8
1663240	4200-G02	9 x 12	No. 4200-02 - in a sheet-metal case 13 17 19 13 17 19 and -ratchet head	20-150	15-110	10 N-m	5.5
1547127	4201-G01	14 x 18	No. 4201-01 - in a sheet-metal case 17 19 24 17 19 24 and -ratchet head	20-200	15-150	10 N-m	6.2
1547135	4300-G01	14 x 18	No. 4300-01 - in a sheet-metal case 24 30 32 24 30 32 36 and -ratchet head	60-300	45-220	10 N-m	6.4
1547143	4301-G01	14 x 18	No. 4301-01 - in a sheet-metal case 24 30 32 24 30 32 36 and -ratchet head	75-400	55-300	10 N-m	6.6

TORCOFIX FS

4150 - 4151

TORQUE WRENCH FOR PRE-SETTING TORCOFIX FS 2-200 N-m

- Use:**
- ▶ Controlled screw tightening in the most widely used range of 2 - 200 N-m without scale
 - ▶ For use in almost all industrial serial manufacturing areas

- Features:**
- ▶ Classified to DIN EN ISO 6789:2003 Type II Class B, with a factory certificate. Working accuracy: +/- 3% tolerance of scale set torque. The specification of the standard (+/- 4%) is exceeded.
 - ▶ Pre-set torque wrench with rectangular cavity
 - ▶ For controlled bi-directional tightening
 - ▶ With certificate acc. to DIN EN ISO 6789, traceable via in-house DKD laboratory to national standards
 - ▶ Release system triggers a tactile and audible signal
 - ▶ Robust, satin chrome-plated tubular steel construction
 - ▶ Factory depth gauges: 17.5 mm (9x12) or 25 mm (14x18)
 - ▶ Operation only with end fittings with standardised depth gauges, otherwise inaccuracies can arise
 - ▶ Depending on the application, access is possible from the front (e.g. rectangular open-end fitting) or side (e.g. reversible ratchet and socket)
 - ▶ If a factory setting is required, please specify the N-m value on the order

9x12

14x18



Code	No.	□mm	N-m _{min/max}	lwFS	lcFS	a	b	c	mm
7601960	4150-25	9 x 12	2 / 25	134	17.5	22	31	186	210
7602180	4150-50	9 x 12	5 / 50	194	17.5	22	31	246	270
7602850	4150-85	9 x 12	15 / 85	277	17.5	22	31	329	340
7603580	4151-20	14 x 18	20 / 200	354	25.0	33	42	407	750





TORQUE SCREWDRIVERS 756

A RANGE OF COMPACT AND VERSATILE TORQUE SCREWDRIVERS WITH AUTOMATICALLY ACTUATING, DIAL-INDICATING AND MEASURING TORQUE.

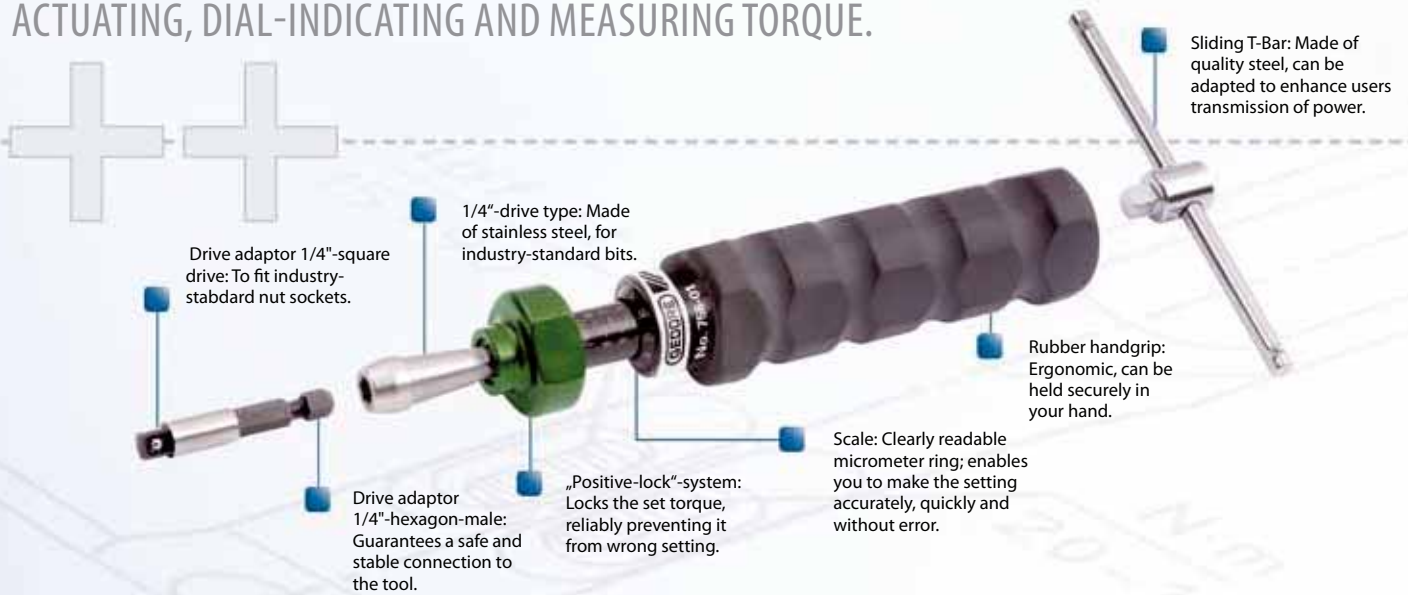

i TORQUE SCREWDRIVER TECHNICAL FEATURES

Type FS 755
Pre-set torque screwdriver without scale for durable and identical value tightening
Auto setting
Bidirectional
Anodised aluminium handgrip

Type 756
Adjustable torque screwdriver with micrometer scale
"Positive-lock"-system
Drive type made of stainless steel
Auto setting
Bidirectional
Non-slip rubber handgrip
EPA > see product

Type S 757
Adjustable torque screwdriver with micrometer scale
Auto setting
Bidirectional
Anodised aluminium handgrip

Type SP 758
Dial-indicating torque screwdriver with dual scale
Locking of maximum values / maximum value-display
Bidirectional
Anodised aluminium handgrip
EPA > see product



Scope of delivery
We supply a 1/4"-1/4"-drive adaptor with all models
To make work easier, a sliding or removable T-bar is included with several models



Special models
Optionally, all torque screwdrivers are also available with a 1/4" male square drive spindle.
Apart from that: Torque screwdrivers for the medical "clean-room" area are available on request.

➔ 685 690

222

➔ 20 IN 20

152 - 155



755

TORQUE SCREWDRIVER TYPE FS 0.02-13.6 N-m

Use:

- Controlled screw tightening in the range 0.02 N-m - 13.6 N-m
- Serial manufacture with constant tightening value
- Electronic industry, precision mechanics and industrial manufacturing

Features:

- Pre-set torque screwdriver without a scale
- With 1/4" female hexagon drive for use with 1/4" hexagon bits as per DIN 3126 - C 6.3
- With adaptor also suitable for 1/4" square drive sockets as per DIN 3124
- Working accuracy: +/- 6% tolerance of the set torque
- Acc. to DIN EN ISO 6789, traceable to national standards
- Precision radial ball clutch and cam design for controlled bi-directional tightening
- Precision mechanism slips very noticeably through when the set torque is reached
- Automatic resetting to the starting position
- 5 models in the range 0.02 N-m to 13.6 N-m
- Lightweight construction by virtue of anodised aluminium handgrips
- The pre-setting can be made at the factory or by the user on suitable torque testers
- If ordering, please specify the N-m value - if a fixed factory setting is desired (price on request)

Scope of delivery:

- Torque screwdriver type 755
- 1/4" square/hexagon drive adaptor (no. 757-20)
- Model 755-05 with additional removable T-bar - for ease of use
- Test certificate acc. to DIN EN ISO 6789
- Delivered in sturdy cardboard packaging

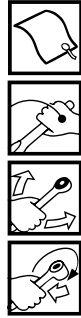

Code	No.	□"	□	■"	■	cN-m	N-m	↳mm±	Colour	↕
1471481	755-01	1/4	6.3	1/4	6.3	2-22		76	red	50
1471473	755-02	1/4	6.3	1/4	6.3	0,5-22		104	gold	72
1471465	755-03	1/4	6.3	1/4	6.3	2-135		111	blue	210
1471457	755-04	1/4	6.3	1/4	6.3	6-406		127	green	280
1228501	755-05	1/4	6.3	1/4	6.3		1-13,6	137	black	325

757

TORQUE SCREWDRIVER TYPE S 0.2-9 N-m

Use:

- Controlled screw tightening in the range 20 cN-m - 9 N-m
- High-speed, controlled tightening enables serial production
- Electrical and electronic hardware industry, instrument-making industry and industrial manufacturing or in quality control

Features:

- Adjustable torque screwdriver with scale
- With 1/4" female hexagon drive for use with 1/4" hexagon bits as per DIN 3126 - C 6.3
- With adaptor also suitable for 1/4" square drive sockets as per DIN 3124
- Working accuracy: +/- 6% tolerance of the set torque
- Acc. to DIN EN ISO 6789, traceable to national standards
- Precision radial ball clutch and cam design for controlled bi-directional tightening
- Precision mechanism slips very noticeably through when set torque is reached
- Automatic resetting to the starting position
- Locking of the value by means of an adjusting knob
- 3 models in the range 20 cN-m to 9 N-m
- Micrometer scale graduation: 1 cN-m / 0.1 N-m
- Lightweight construction by virtue of anodised aluminium handgrips

Scope of delivery:

- Torque screwdriver type 757
- 1/4" square/hexagon drive adaptor (no. 757-20)
- Models 757-06/-09 with additional sliding T-bar (no. 757-21) - for ease of use
- Test certificate acc. to DIN EN ISO 6789
- Delivered in sturdy cardboard packaging

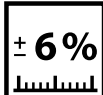

Code	No.	□"	□	■"	■	cN-m	N-m	↳mm±	Colour	↕	
7718050	757-01	1/4	6.3	1/4	6.3	20-120		169	1,0 cN-m	black	165
7718130	757-06	1/4	6.3	1/4	6.3		1-6	184	0,1 N-m	red	400
7718210	757-09	1/4	6.3	1/4	6.3		4-9	184	0,1 N-m	green	400

756

TORQUE SCREWDRIVER TYPE S 0.05-9 N-m

Use:

- Controlled screw tightening in the range 0.05 - 9 N-m
- High-speed, controlled tightening enables serial production
- Electrical and electronic hardware industry, instrument-making industry and industrial manufacturing or in quality control

Features:

- Adjustable torque screwdriver - with scale
- With 1/4" female hexagon drive for use with 1/4" hexagon bits as per DIN 3126 - C 6.3
- With adaptor also suitable for 1/4" square drive sockets as per DIN 3124
- Actuation accuracy: +/- 6% tolerance of the set value
- Acc. to DIN EN ISO 6789, traceable to national standards
- Precision radial ball clutch and cam design for controlled bi-directional tightening
- Precision mechanism slips very noticeably through when the set torque is reached
- Automatic resetting to the starting position
- "Positive-Lock" system automatically fixes the set value preventing it from wrong setting.
- 4 models in the range 0.05 N-m to 9 N-m
- Micrometre scaling: 1 cN-m and 0.1 N-m
- Very convenient, lightweight and non-slip rubber handgrip
- EPA-conformant (Electrostatic Protected Area), for use in sensitive electrostatic applications

Scope of delivery:

- Torque wrench type 756
- 1/4" square/hexagon drive adapter (no. 757-20)
- Models 756-06/-09 with additional sliding T-bar (no. 757-21) - for ease of use
- Test certificate acc. to DIN EN ISO 6789
- Delivered in sturdy cardboard packaging

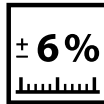

Code	No.	□"	□	■"	■	cN-m	N-m	↳mm±	Colour	↕	
1498738	756-00	1/4	6.3	1/4	6.3	5-40		159	1 cN-m	silver	124
1400150	756-01	1/4	6.3	1/4	6.3	20-120		183	1 cN-m	blue	165
1400169	756-06	1/4	6.3	1/4	6.3		1-6	196	0,1 N-m	red	340
1400177	756-09	1/4	6.3	1/4	6.3		4-9	196	0,1 Nm	green	340

758

TORQUE SCREWDRIVER TYPE SP 10-500 cN-m / 14 ozf-in - 40 lbf-in

Use:

- In the torque range 10 cN-m - 500 cN-m
- For test and installation work in the electrical and electronic hardware industry, instrument-making industry and industrial manufacturing or in quality control

Features:

- Dial-indicating torque and test screwdriver - with dual scale (cN-m/ozf-in/lbf-in)
- With 1/4" female hexagon drive for use with 1/4" hexagon bits as per DIN 3126 - C 6.3
- With adaptor also suitable for 1/4" square drive sockets as per DIN 3124
- Display accuracy: +/- 6% tolerance of the indicated value
- Acc. to DIN EN ISO 6789, traceable to national standards
- For controlled bi-directional tightening
- With slave-pointer function
- For locking of maximum values / maximum-value display
- 4 models in the range 10 cN-m to 500 cN-m
- Lightweight construction by virtue of anodised aluminium handgrips
- EPA-conformant (Electrostatic Protected Area), for use in sensitive electrostatic applications

Scope of delivery:

- Torque screwdriver type 758
- 1/4" square/hexagon drive adapter (no. 757-20)
- Models 758-25/-50 with additional sliding T-bar (no. 757-21) - for ease of use
- Test certificate acc. to DIN EN ISO 6789
- Delivered in sturdy cardboard packaging



Code	No.	□"	□	■"	■	cN-m	ozf-in / lbf-in	↳mm±	Colour	↕	
7096380	758-05	1/4	6.3	1/4	6.3	10-50	14-70 ozf-in	178	2 cN-m / 2 ozf-in	gold	190
7096460	758-10	1/4	6.3	1/4	6.3	20-100	28-140 ozf-in	178	5 cN-m / 5 ozf-in	blue	190
7096540	758-25	1/4	6.3	1/4	6.3	50-250	4-20 lbf-in	250	10 cN-m / 0,5 lbf-in	red	465
7096620	758-50	1/4	6.3	1/4	6.3	100-500	8-40 lbf-in	250	20 cN-m / 1 lbf-in	green	465



TORQUE WRENCHES TSN-TBN-TSP-TSC

i TSN SLIPPER

Pre-set ratchet head torque wrench with automatic actuation and slip function. Over-tightening is not possible.



i TSN SLIPPER Working principle

When the pre-set torque value is achieved, the mechanism slips through over the ball (without the possibility of over-tightening). The torque wrench is then immediately ready for the next operation.

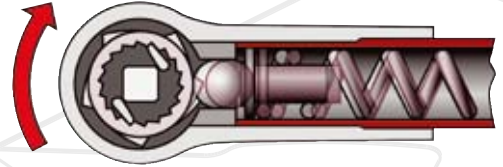

759

TORQUE WRENCH TSN SLIPPER 3-125 N-m

Use:

- ✔ Controlled screw tightening in the range 3 N-m - 125 N-m
- ✔ Serial / production-line assembling
- ✔ Extremely long-term work

Features:

- ✔ Pre-set production torque wrench - without scale
- ✔ 1/4", 3/8" or 1/2" square drive with ball locking device
- ✔ With integrated ratchet-function for controlled clockwise tightening
- ✔ Working accuracy: +/- 4% tolerance of the set torque
- ✔ Acc. to DIN EN ISO 6789, traceable to national standards
- ✔ Precision mechanism slips very noticeably and audibly ("click") when the pre-set value is achieved - over-tightening is not possible
- ✔ Automatic resetting to the starting position
- ✔ 4 models in the range 3 N-m to 125 N-m
- ✔ Lightweight yet robust and corrosion-resistant construction design
- ✔ Very convenient non-slip rubber handgrip
- ✔ The pre-setting can be made at the factory or by the user on suitable torque testers
- ✔ If ordering, please specify the N-m value - if a factory pre-setting is desired (price on request)

Scope of delivery:

- ✔ Torque wrench type TSN SLIPPER
- ✔ Special adjusting key for changing the pre-set torque value
- ✔ Test certificate acc. to DIN EN ISO 6789
- ✔ Delivered in sturdy cardboard packaging



- 6,3 1/4"
 - 10 3/8"
 - 12,5 1/2"
-

Code	No.	■"	■	N-m	(mm)	Cams per turn	±%
7091900	759-00	1/4	6.3	3-25	216	10	340
7092040	759-01	3/8	10.0	3-25	216	10	340
7092120	759-02	3/8	10.0	15-55	324	10	800
7092200	759-03	1/2	12.5	40-125	460	8	1360

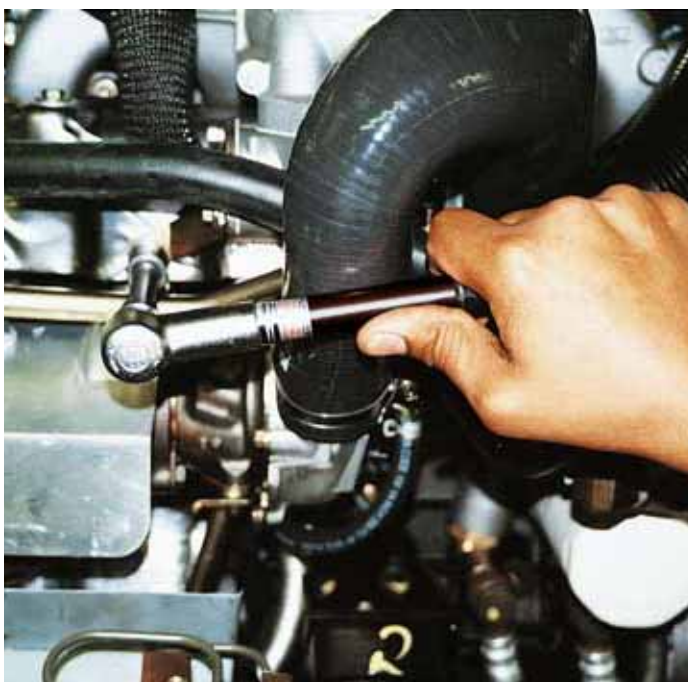

i TSN SLIPPER TBN BREAKER
Technical information

All TSN Slippers and TBN Breaker torque wrenches (apart from 760-00/-01) are fitted with the patented "Mechanical Torque Adjustment Locking Device" to modify torque tester.

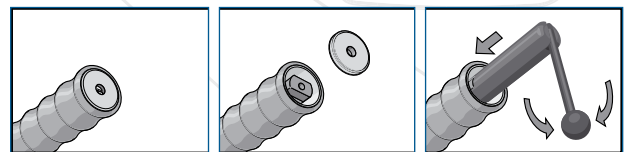

www.gedore.com



TBN KNICKER

Pre-set torque wrench with automatic snap actuation. Torque wrench offering maximum accuracy. Guaranteed tightening values without over-tightening.



As an option, we also manufacture the TBN KNICKER models 760-00/-01 with exchangeable fittings directly positioned on the tool.



TBN BREAKER Working principle

When the TBN breaking torque wrench is operated, the rear section of the driver unit presses the roller. When the pre-set torque value is achieved, the lever switches over and the front section of the drive unit breaks.

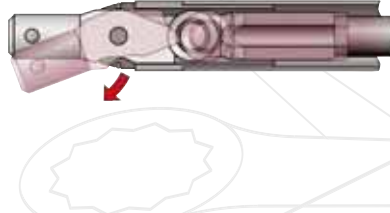

TBN KNICKER Technik

TBN KNICKER 760-00/-01 values are changed using the "Double Positive" adjustment system.



760

BREAKING TORQUE WRENCH TBN 0.2-135 N-m / 1.8-1195 lbf-in

Use:

- Controlled screw tightening in the range 0.2 - 135 N-m
- Serial / production-line assembling
- Extremely long-term work

Features:

- Pre-set production torque wrench - without scale
- With 9x12 mm rectangular-cavity-end or 16 mm spigot-end
- For bi-directional tightening (the wrench only has to be turned by 180°)
- Working accuracy: +/- 4% tolerance of the set torque
- Acc. to DIN EN ISO 6789, traceable to national standards
- Breaking of the handgrip by 20° (90° also possible in the case of no. 760-00/-01) when the pre-set torque value is achieved makes over-tightening unlikely
- Automatic resetting to the starting position
- 8 models in the range 0.2 to 135 N-m
- Lightweight yet robust and corrosion-resistant construction design
- Very convenient non-slip rubber handgrip
- No. 760-00/-01: EPA (Electrostatic Protected Area) compliant
- The pre-setting can be made at the factory or by the user on suitable torque testers
- If ordering, please specify the N-m value - if a fixed factory pre-setting is desired (price on request)

Scope of delivery:

- TBN breaking torque wrench
- Adjusting tool for changing the pre-set torque value
- Test certificate acc. to DIN EN ISO 6789
- Delivered in sturdy cardboard packaging

16

9x12

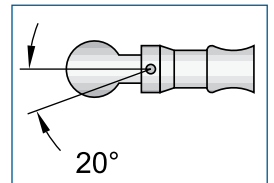

Code	No.	Ø	□mm	EPA	N-m	lbf-in	□mm	□mm
7090690	760-00	9 x 12	x	x	0,2-2,0	1,8-18	105	110
7090770	760-01	9 x 12	x	x	1-10	9-89	105	130
1824686	760-30	16			5-25	44-221	265	405
1824694	760-35	9 x 12			5-25	44-221	265	405
1824708	760-40	16			10-65	89-575	302	745
1824716	760-45	9 x 12			10-65	89-575	302	745
1824724	760-50	16			20-135	177-1195	408	1027
7092630	760-11	9 x 12			20-135	177-1195	408	830

765

ADJUSTABLE BREAKING WRENCH ATB with scale 5-25 N-m

- With micrometer scale, which allows quick and precise adjustment of the desired value
- With adjuster lock that prevents accidental adjustment during use
- Working accuracy: +/- 4% tolerance of the set torque
- Breaking of the handgrip by 20° when the pre-set torque value is achieved makes over-tightening unlikely
- Classified to DIN EN ISO 6789:2003 Type II Class A



Code	No.	Ø	□mm	N-m	□mm	□mm
2312816	765-25	16		5-25	297	678
2312824	765-30	9 x 12		5-25	303	700



- On request, all torque wrenches can be factory pre-set.
- When ordering, please specify the N-m value.



761

TORQUE WRENCH TSP SLIPPER 1-10 N-m / 10-90 lbf-in

Use:

- Controlled screw tightening in the range 1 - 10 N-m
- Ideal for assembly work where controlled tightening with low torque values is required (e.g. electronic hardware sector, precision mechanics etc.)

Features:

- Pre-set production torque wrench - without scale
- 1/4" square drive with ball locking device
- With integrated ratchet-function for controlled clockwise tightening
- Working accuracy: +/- 6% tolerance of the set torque
- Acc. to DIN EN ISO 6789, traceable to national standards
- Precision mechanism slips very noticeably and audibly ("click") when the pre-set value is reached - over-tightening is not possible
- Automatic resetting to the starting position
- 2 models in the range 1 N-m to 10 N-m
- Extremely lightweight yet robust and corrosion-resistant construction design
- Very convenient non-slip rubber handgrip
- EPA-conformant (Electrostatic Protected Area), for use in sensitive electrostatic applications
- The pre-setting can be made at the factory or by the user on suitable torque testers
- If ordering, please specify the N-m value - if a fixed factory pre-setting is desired (price on request)

Scope of delivery:

- Torque wrench type TSP SLIPPER
- Adjusting tool for changing the pre-set torque value
- Test certificate acc. to DIN EN ISO 6789
- Delivered in sturdy cardboard packaging

6,3

1/4"



Code	No.	□"	□	N-m	lbf-in	(+mm-)	↻
1196650	761-05	1/4	6.3	1-5	10-45	185	190
1196731	761-10	1/4	6.3	2-10	20-90	185	190

762

TORQUE WRENCH TSC SLIPPER 1-10 N-m

Use:

- Controlled screw tightening in the range 1 - 10 N-m
- Ideal for assembly work where controlled tightening with low torque values is required (e.g. electronic hardware sector, precision mechanics etc.)

Features:

- Adjustable torque wrench - with scale
- 1/4" square drive with ball locking device
- With integrated ratchet-head function for controlled clockwise tightening
- Working accuracy: +/- 6% tolerance of set torque
- Acc. to DIN EN ISO 6789, traceable to national standards
- Precision mechanism slips very noticeably and audibly ("click") when the set torque is reached - over-tightening is not possible
- Automatic resetting to the starting position
- Micrometer scale graduation: 0.05 N-m / 0.1 N-m
- 2 models in the range 1 N-m to 10 N-m
- Extremely lightweight yet robust and corrosion-resistant construction design
- Very convenient non-slip rubber handgrip
- EPA-conformant (Electrostatic Protected Area), for use in sensitive electrostatic applications

Scope of delivery:

- Torque wrench type TSC SLIPPER
- Test certificate acc. to DIN EN ISO 6789
- Delivered in sturdy cardboard packaging

6,3

1/4"



Code	No.	□"	□	N-m	(+mm-)	↻	↻
1196480	762-05	1/4	6.3	1-5	195	0,05 N-m	235
1196510	762-10	1/4	6.3	2-10	195	0,1 N-m	235

TORQUE WRENCH TYPE 88

8800

TORQUE WRENCH TYPE 88 100-1500 N-m / 70-1000 lbf-ft

Use:

- Controlled screw tightening in the range 100 N-m - 1500 N-m
- Industry and vehicle sector (lorries, industrial vehicles), machine maintenance

Features:

- Adjustable torque wrench - with scale
- 3/4" square drive with integrated ratchet-function or 22 mm spigot-end
- Suitable for bi-directional tightening on account of push-through square drive
- Working accuracy: +/- 4% tolerance of the value setting
- Acc. to DIN EN ISO 6789, traceable to national standards
- Breaking mechanism as an actuation signal which can be seen and felt and makes over-tightening unlikely
- Dual scale in N-m and lbf-ft
- 5 models in the range 100 - 1500 N-m

Scope of delivery:

- Type 88 breaking torque wrench
- Operating instructions are provided on a label on the torque wrench
- Test certificate acc. to DIN EN ISO 6789
- Delivered in sturdy cardboard packaging

20

3/4"

22

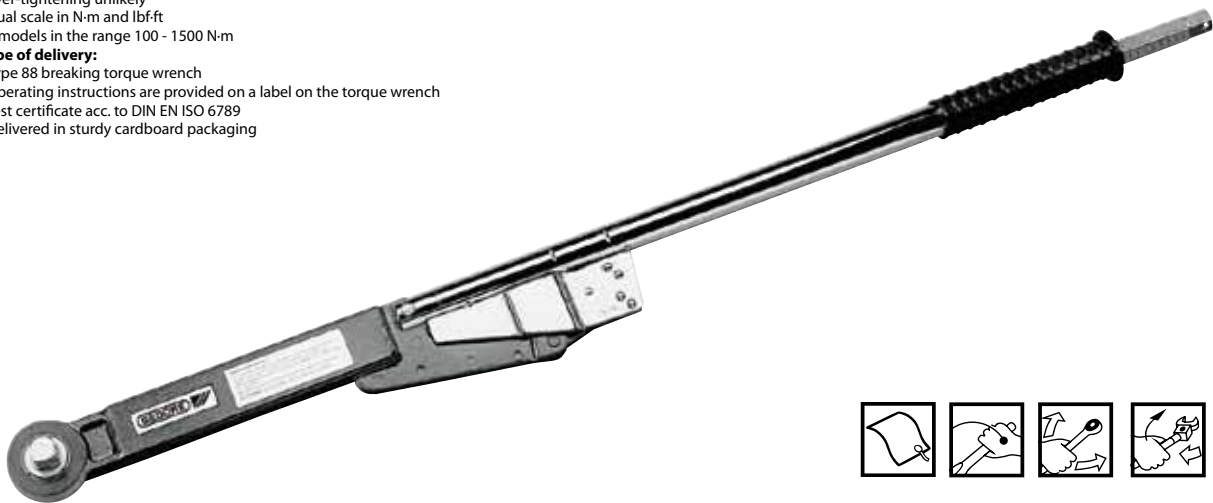

Code	No.	∅	□"	□	N-m	lbf-ft	(+mm-)	↻
7715700	8800-01	3/4	20	100-500	70-350	915	10 N-m	5.5
7715890	8800-02	3/4	20	150-700	100-500	1090	10 N-m	6.0
7716000	8800-03	3/4	20	300-1000	200-750	1470	20 N-m	7.3
7716190	8800-04	3/4	20	700-1500	500-1000	1470	25 N-m	10.5
7716270	8800-06	22		130-550	100-400	915	10 N-m	4.9



TORQUE WRENCH TYPE 83

i Torque wrenches with slave pointer Ideal for test, control and maintenance work



Clear product identification: Provided by the type plate/label. The article number and the serial number always ensure traceability in the scope of your test- and checking-tool management.



Audio-visual signal: Standard feature or else optionally: All models are available with an audio-visual signal for even clearer recognition of the achieved torque.

Practical handgrip: Handgrip shaped in accordance with the most recent ergonomic findings. Resistant to grease and oil.

i Features

The working principle of the torque wrench with slave pointer type 83



Integrated ratchet spindle: With double square drive enables high-speed bi-directional tightening.



Solid tube: Light-metal tube with plastic sleeving.

Dual scale: N-m and lbf-in/ lbf-ft with main and slave pointers, protected by a strong window made of Trogamid "T".

8301 - 8305

TORQUE WRENCH WITH SLAVE POINTER TYPE 83 0.8-2000 N-m / 7 lbf-in - 1500 lbf-ft

Use:

- Controlled tightening and verification of tightening values
- For use in all areas of industrial manufacturing and in quality control
- Working ranges of 0.8 to 2000 N-m are covered

Features:

- Dial-indicating torque wrench with dual scale and multi-functional slave pointer
- 1/4", 3/8", 1/2", 3/4" or 1" double-square drive with ball locking device
- With integrated ratchet-function for controlled bi-directional tightening
- For controlled screw tightening and torque measurements
- Working accuracy: +/- 4% tolerance of the indicated torque
- Acc. to DIN EN ISO 6789, traceable to national standards
- With dual scale in N-m and lbf-in or lbf-ft double-tinted clearly readable face
- Integrated overload protection - mechanical stop up to max. 25% overload of the maximum value
- Housing made of lightweight, robust special aluminium construction - lacquered, silver-grey
- Black, non-slip rubber handgrips
- 10 models in the range 0.8 - 2000 N-m
- Models 8301-04 to 8301-40: EPA conform (Electrostatic Protected Area)
- Audio-visual signal is standard on models 8303-40 to 8305-20

Scope of delivery:

- Dial-measuring torque wrench type 83
- Battery for models having audio-visual signal
- Test certificate acc. to DIN EN ISO 6789
- Delivered in a sturdy black plastic box (no. 8301-04 to 8302-20), otherwise in sturdy cardboard packaging (no. 8303-40 to 8305-20)

- 6,3 1/4"
- 10 3/8"
- 12,5 1/2"
- 20 3/4"
- 25 1"



Code	No.	Type	█"	█"	EPA	N-m	lbf-in	lbf-ft	█mm█	█mm█	Height	Signal	█
7651390	8301-04	↔	1/4	6.3	x	0,8-4	7-35		244	0,1 N-m / 1 lbf-in	61	optional	500
7651470	8301-12	↔	1/4	6.3	x	2,4-12	21-105		244	0,5 N-m / 2 lbf-in	61	optional	500
7651550	8301-25	↔	3/8	10.0	x	5-25	44-220		244	1 N-m / 10 lbf-in	69	optional	500
7651630	8301-40	↔	3/8	10.0	x	8-40	72-360		244	1 N-m / 10 lbf-in	69	optional	500
7651710	8302-08	↔	1/2	12.5		16-80		12-60	435	2 N-m / 1 lbf-ft	86	optional	1350
7651980	8302-20	↔	1/2	12.5		40-200		30-160	515	5 N-m / 5 lbf-ft	86	optional	1400
7652280	8303-40	↔	3/4	20.0		80-400		60-300	710	10 N-m / 10 lbf-ft	111	standard	3150
7652010	8304-80	↔	3/4	20.0		160-800		120-600	1000	20 N-m / 20 lbf-ft	123	standard	4850
1196790	8305-14	↔	1	25.0		280-1400		200-1000	2040	25 N-m / 25 lbf-ft	138	standard	16690
1196804	8305-20	↔	1	25.0		400-2000		300-1500	2040	50 N-m / 50 lbf-ft	138	standard	16690



END FITTINGS 16 Z

8791

OPEN END FITTING 16 Z

- ▶ For accessing bolts in cramped and hard-to-reach locations, easy to change
- ▶ Forged
- ▶ Chrome-vanadium steel, chrome-plated
- ▶ With eject-pin for unlocking



Code	No.	∅	Q _{mm}	mm _{1/16}	Q _{mm}	Depth gauge	±
7774470	8791-07	16	7	5	20.5	32	80
7774550	8791-08	16	8	5	20.5	32	80
7774630	8791-09	16	9	5	20.5	32	80
7710070	8791-10	16	10	7	29.0	32	90
7710150	8791-11	16	11	7	29.0	32	90
7676890	8791-12	16	12	7	29.0	32	90
7710230	8791-13	16	13	8	34.5	32	120
7710310	8791-14	16	14	8	34.5	32	120
7710580	8791-15	16	15	8	34.5	32	120
7710660	8791-16	16	16	9	41.5	32	160
7710740	8791-17	16	17	9	41.5	32	160
7676970	8791-18	16	18	9	41.5	32	160
7710820	8791-19	16	19	10	45.0	32	180
7710900	8791-20	16	20	10	45.0	32	180
7677000	8791-21	16	21	10	45.0	32	180
7711040	8791-22	16	22	11	56.0	32	220
1977164	8791-23	16	23	11	56.0	32	220
7711120	8791-24	16	24	11	56.0	32	220
1552279	8791-25	16	25	11	56.0	32	220
1552287	8791-26	16	26	11	56.0	32	220
7711200	8791-27	16	27	12	60.5	32	260
1207008	8791-28	16	28	12	68.0	32	300
1552309	8791-29	16	29	12	68.0	32	300
7774710	8791-30	16	30	12	68.0	32	300
7774980	8791-32	16	32	12	68.0	32	300
1552317	8791-36	16	36	12	68.0	32	300

Code	No.	∅	Q _{AF}	mm _{1/16}	Q _{mm}	Depth gauge	±
1211421	8791-1/4AF	16	1/4	5	20.5	32	90
7720030	8791-5/16AF	16	5/16	5	20.5	32	80
1211447	8791-3/8AF	16	3/8	7	29.0	32	90
7720110	8791-7/16AF	16	7/16	7	29.0	32	90
7720380	8791-1/2AF	16	1/2	8	34.5	32	90
7720460	8791-9/16AF	16	9/16	8	34.5	32	120
7720540	8791-5/8AF	16	5/8	9	41.5	32	160
7720620	8791-11/16AF	16	11/16	9	41.5	32	160
7720700	8791-3/4AF	16	3/4	10	45.0	32	180
1211439	8791-13/16AF	16	13/16	10	45.0	32	90
7720890	8791-7/8AF	16	7/8	10	45.0	32	220
7720970	8791-15/16AF	16	15/16	11	56.0	32	220
7721000	8791-1AF	16	1	11	56.0	32	220
7721190	8791-1.1/16AF	16	1.1/16	12	60.5	32	260
7721270	8791-1.1/8AF	16	1.1/8	12	68.0	32	300
7776170	8791-1.3/16AF	16	1.3/16	12	68.0	32	300
7776250	8791-1.1/4AF	16	1.1/4	12	68.0	32	300
7776330	8791-1.5/16AF	16	1.5/16	12	68.0	32	300

8792

RING END FITTING 16 Z

- ▶ For accessing bolts in cramped and hard-to-reach locations, easy to change
- ▶ Forged
- ▶ Chrome-vanadium steel, chrome-plated
- ▶ With eject-pin for unlocking



Code	No.	∅	Q _{mm}	mm _{1/16}	Q _{mm}	Depth gauge	±
7775010	8792-07	16	7	8	15.0	32	90
7775280	8792-08	16	8	8	15.0	32	90
7775360	8792-09	16	9	8	15.0	32	90
7712600	8792-10	16	10	10	19.5	32	100
7712790	8792-11	16	11	10	19.5	32	100
7677190	8792-12	16	12	10	19.5	32	100
7712870	8792-13	16	13	12	23.5	32	140
7712950	8792-14	16	14	12	23.5	32	140
7713090	8792-15	16	15	12	23.5	32	140
7713170	8792-16	16	16	13	28.5	32	180
7713250	8792-17	16	17	13	28.5	32	180
7677270	8792-18	16	18	13	28.5	32	180
7713330	8792-19	16	19	14	31.5	32	210
7713410	8792-20	16	20	14	31.5	32	210
7677350	8792-21	16	21	14	31.5	32	210
7713680	8792-22	16	22	15	39.5	32	260
1211471	8792-23	16	23	15	39.5	32	270
7713760	8792-24	16	24	15	39.5	32	260
7713840	8792-27	16	27	16	41.5	32	300

Code	No.	∅	Q _{AF}	mm _{1/16}	Q _{mm}	Depth gauge	±
1211455	8792-1/4AF	16	1/4	8	15.0	32	100
7721350	8792-5/16AF	16	5/16	8	15.0	32	90
1211498	8792-3/8AF	16	3/8	10	19.5	32	100
7721430	8792-7/16AF	16	7/16	10	19.5	32	100
7721510	8792-1/2AF	16	1/2	12	23.5	32	100
7721780	8792-9/16AF	16	9/16	12	23.5	32	140
7721860	8792-5/8AF	16	5/8	13	28.5	32	140
7721940	8792-11/16AF	16	11/16	13	28.5	32	180
7722080	8792-3/4AF	16	3/4	14	31.5	32	210
1211463	8792-13/16AF	16	13/16	14	31.5	32	100
7722160	8792-7/8AF	16	7/8	15	39.5	32	260
7722240	8792-15/16AF	16	15/16	15	39.5	32	260
7722320	8792-1AF	16	1	15	39.5	32	300
7722400	8792-1.1/16AF	16	1.1/16	16	41.5	32	300



DREMOMETER Z / TORCOFIX Z



**249
254**



www.gedore.com



8797

FLARED END FITTING 16 Z

- For accessing bolts in cramped and hard-to-reach locations, easy to change
- Forged
- Chrome-vanadium steel, chrome-plated
- With eject-pin for unlocking



16

Code	No.	Ø	Ø mm	mm _{1/2}	Ø mm	max. N·m	Depth gauge	Opening width	±
1211587	8797-07	16	7	8.0	15.0	7.0	32	5.5	90
1211595	8797-08	16	8	8.0	15.0	6.5	32	6.0	90
1211609	8797-09	16	9	8.0	15.0	5.5	32	6.5	90
1211625	8797-10	16	10	10.0	19.5	26.0	32	7.0	100
1211633	8797-11	16	11	10.0	19.5	19.0	32	8.5	100
1211641	8797-12	16	12	10.0	19.5	13.0	32	9.0	120
1211668	8797-13	16	13	12.0	23.5	34.0	32	10.0	140
7664290	8797-14	16	14	12.0	23.5	24.0	32	11.2	140
1211684	8797-15	16	15	12.0	23.5	18.0	32	12.0	140
1211692	8797-16	16	16	13.0	28.5	66.0	32	13.0	180
1211706	8797-17	16	17	13.0	28.5	56.0	32	14.0	180
1211714	8797-18	16	18	13.0	28.5	45.0	32	14.5	200
1211722	8797-19	16	19	14.0	31.5	80.0	32	15.0	210
1211731	8797-20	16	20	14.0	31.5	60.0	32	16.0	210
1211749	8797-21	16	21	14.0	31.5	43.0	32	16.5	210
1211757	8797-22	16	22	15.0	39.5	172.0	32	17.0	260
1211765	8797-23	16	23	15.0	39.5	153.0	32	17.5	260
1211773	8797-24	16	24	15.0	39.5	118.0	32	18.0	260
1211781	8797-27	16	27	16.0	41.5	76.0	32	20.0	300

Code	No.	Ø	Ø _{AF}	mm _{1/2}	Ø mm	max. N·m	Depth gauge	±
1326503	8797-1/4AF	16	1/4	8.0	15.0	7.0	32	90
7709300	8797-5/16AF	16	5/16	8.0	15.0	6.5	32	90
1211803	8797-3/8AF	16	3/8	10.0	19.5	26.0	32	140
7715620	8797-7/16AF	16	7/16	10.0	19.5	18.0	32	100
7715970	8797-1/2AF	16	1/2	12.0	23.5	37.0	32	140
7716350	8797-9/16AF	16	9/16	12.0	23.5	22.0	32	140
7716430	8797-5/8AF	16	5/8	13.0	28.5	68.0	32	180
7719610	8797-11/16AF	16	11/16	13.0	28.5	51.0	32	180
7719880	8797-3/4AF	16	3/4	14.0	31.5	77.0	32	210
1211676	8797-13/16AF	16	13/16	14.0	31.5	58.0	32	370
7725180	8797-7/8AF	16	7/8	15.0	39.5	169.0	32	210
7719960	8797-15/16AF	16	15/16	15.0	39.5	138.0	32	210
7725260	8797-1AF	16	1	15.0	39.5	104.0	32	260
7725340	8797-1.1/16AF	16	1.1/16	16.0	41.5	77.0	32	300

8755

END FITTING TORX® 16 Z

- For accessing bolts in cramped and hard-to-reach locations, easy to change
- For recessed TORX® head screws
- Forged
- Chrome-vanadium steel, chrome-plated
- With eject-pin for unlocking
- TORX® = registered trademark of Acument Intellectual Properties, LLC. USA



16

Code	No.	Ø	Ø	Depth gauge	±
7672040	8755-20	16	20	32	100
7672120	8755-25	16	25	32	100
7672200	8755-27	16	27	32	140
7672390	8755-30	16	30	32	140
7672470	8755-40	16	40	36	140
7672550	8755-45	16	45	36	180

8756

END FITTING INBUS® 16 Z

- For accessing bolts in cramped and hard-to-reach locations, easy to change
- Forged
- Chrome-vanadium steel, chrome-plated
- With eject-pin for unlocking
- INBUS® = registered trademark of Acument GmbH & Co. OHG, 56567 Neuwied



16

Code	No.	Ø	Ø mm	Depth gauge	±
7773740	8756-03	16	3	32	100
7773820	8756-04	16	4	32	100
7773900	8756-05	16	5	32	100
7774040	8756-06	16	6	32	100
7774120	8756-08	16	8	36	110

8754

RATCHET HEAD 16 Z

- For accessing bolts in cramped and hard-to-reach locations, easy to change
- Forged
- Chrome-vanadium steel, matt chrome-plated
- With eject pin for unlocking
- Max. continuous load of coupler according to DIN EN ISO 6789:2003 and/or maximum support load
 - 8754-01 3/8" = 135 N·m
 - 8754-02 1/2" = 340 N·m



16

10

3/8

12.5

1/2

Code	No.	Ø	Type	Ø"	Ø mm	Depth gauge	±
7711980	8754-01	16	●	3/8	10.0	32	170
7712010	8754-02	16	●	1/2	12.5	32	270

8790 - 8793

FIXED SQUARE HEAD 16 Z

- For accessing bolts in cramped and hard-to-reach locations, easy to change
- Forged
- Chrome-vanadium steel, matt chrome-plated
- With eject pin for unlocking
- Max. continuous load of coupler according to DIN EN ISO 6789:2003 and/or maximum support load
 - 879000 3/8" = 135 N·m
 - 879300 1/2" = 340 N·m



16

10

3/8

12.5

1/2

Code	No.	Ø	Type	Ø"	Ø mm	Depth gauge	±
7709490	8790-00	16	■	3/8	10.0	32	350
7709570	8793-00	16	■	1/2	12.5	32	380



END FITTINGS 22 Z

8795

OPEN END FITTING 22 Z

- ▶ For accessing bolts in cramped and hard-to-reach locations, easy to change
- ▶ Forged
- ▶ Chrome-vanadium steel, chrome-plated
- ▶ With eject-pin for unlocking



Code	No.	∅	∅mm	mm _{AF}	∅mm	Depth gauge	↕
7707010	8795-22	22	22	11	52.0	56	330
7707280	8795-24	22	24	11	52.0	56	320
7707360	8795-27	22	27	12	64.0	56	380
7707440	8795-30	22	30	12	64.0	56	370
7707520	8795-32	22	32	12	75.5	56	450
7677430	8795-34	22	34	12	75.5	56	430
7707600	8795-36	22	36	12	75.5	56	430
7707790	8795-41	22	41	12	94.0	56	580
7707870	8795-46	22	46	12	94.0	56	530

Code	No.	∅	∅AF	mm _{AF}	∅mm	Depth gauge	↕
1532650	8795-1.7/16AF	22	1.7/16	12.0	75.5	56	425
1532669	8795-1.1/2AF	22	1.1/2	12.0	75.5	56	429

8796

RING END FITTING 22 Z

- ▶ For accessing bolts in cramped and hard-to-reach locations, easy to change
- ▶ Forged
- ▶ Chrome-vanadium steel, chrome-plated
- ▶ With eject-pin for unlocking



Code	No.	∅	∅mm	mm _{AF}	∅mm	Depth gauge	↕
7707950	8796-22	22	22	15	38.0	56	350
7708090	8796-24	22	24	15	38.0	56	330
7708170	8796-27	22	27	17	46.5	56	370
7708250	8796-30	22	30	17	46.5	56	350
7708330	8796-32	22	32	20	55.0	56	420
7677510	8796-34	22	34	20	55.0	56	420
7708410	8796-36	22	36	20	55.0	56	390
7708680	8796-41	22	41	22	72.0	56	560
7708760	8796-46	22	46	22	72.0	56	520

Code	No.	∅	∅AF	mm _{AF}	∅mm	Depth gauge	↕
1242962	8796-1AF	22	1	17	46.5	56	400
1532677	8796-1.1/8AF	22	1.1/8	17	46.5	56	400
1532685	8796-1.3/16AF	22	1.3/16	17	46.5	56	470
1532693	8796-1.1/4AF	22	1.1/4	20	55.0	56	550
1532707	8796-1.5/16AF	22	1.5/16	20	55.0	56	460
1532715	8796-1.7/16AF	22	1.7/16	20	55.0	56	430

www.gedore.com

8797

FLARED END FITTING 22 Z

- ▶ For accessing bolts in cramped and hard-to-reach locations, easy to change
- ▶ Forged
- ▶ Chrome-vanadium steel, chrome-plated
- ▶ With eject-pin for unlocking



Code	No.	∅	∅AF	mm _{AF}	∅mm	max. N-m	Depth gauge	Opening width	↕
1532723	8797-1.1/8AF	22	1.1/8	17	46.5	166	56	22	370
1532731	8797-1.3/16AF	22	1.3/16	17	46.5	145	56	22	360
1532758	8797-1.1/4AF	22	1.1/4	20	55.0	396	56	22	440
1532766	8797-1.5/16AF	22	1.5/16	20	55.0	367	56	25	430
1532774	8797-1.7/16AF	22	1.7/16	20	55.0	271	56	26	390

8794

FIXED SQUARE HEAD / RATCHET HEAD 22 Z

- ▶ For accessing bolts in cramped and hard-to-reach locations, easy to change
- ▶ Forged
- ▶ Chrome-vanadium steel, matt chrome-plated
- ▶ With eject-pin for unlocking
- ▶ Max. continuous load of coupler according to DIN EN ISO 6789:2003 and/or maximum support load
- ▶ 879400 3/4" = 850 N-m
- ▶ 8794-03 3/4" = 850 N-m



Code	No.	∅	Type	■"	■	Depth gauge	↕
7708840	8794-00	22		3/4	20	56	610
1427318	8794-03	22		3/4	20	56	950





END FITTINGS 28 Z

8799

RING END FITTING 28 Z

- For accessing bolts in cramped and hard-to-reach locations, easy to change
- Chrome-vanadium steel, chrome-plated
- With catch retention

28



Code	No.	Ø	Ø mm	mm _{1/2}	Ø mm	Depth gauge	↕
1760963	8799-27	28	27	16.0	50.0	75	1500
1760971	8799-30	28	30	17.0	50.0	75	1500
1760874	8799-32	28	32	17.0	54.0	75	1550
1760858	8799-34	28	34	17.0	57.0	75	1550
1565494	8799-36	28	36	19.5	60.0	75	1600
1565508	8799-41	28	41	20.5	66.0	75	1800
1565516	8799-46	28	46	22.5	75.0	75	2100
1565524	8799-50	28	50	23.5	80.0	75	2200
1565532	8799-55	28	55	25.0	87.5	75	2400
1565540	8799-60	28	60	26.0	93.5	75	2500
1565559	8799-65	28	65	29.0	101.0	75	2900
1565567	8799-70	28	70	32.5	109.5	75	2000
1565575	8799-75	28	75	34.0	116.5	100	4500
1565583	8799-80	28	80	35.0	123.0	100	4800
1565591	8799-85	28	85	37.0	131.0	100	5200
1565605	8799-90	28	90	41.5	152.0	100	6700
1565621	8799-95	28	95	41.5	152.0	100	6400
1565648	8799-100	28	100	41.5	152.0	100	6200

8798

OPEN END FITTING 28 Z

- For accessing bolts in cramped and hard-to-reach locations, easy to change
- Chrome-vanadium steel, chrome-plated
- With catch retention

28



Code	No.	Ø	Ø mm	mm _{1/2}	Ø mm	Depth gauge	↕
1760831	8798-32	28	32	17.0	68.8	75	1500
1760823	8798-34	28	34	17.0	73.1	75	1800
1565346	8798-36	28	36	18.0	77.5	75	1900
1565354	8798-41	28	41	19.5	89.0	75	1900
1565362	8798-46	28	46	20.0	99.0	75	1900
1565370	8798-50	28	50	21.5	108.0	75	1900
1565389	8798-55	28	55	24.5	118.5	75	2100
1565397	8798-60	28	60	24.5	129.5	75	2100
1565400	8798-65	28	65	28.0	140.5	75	2400
1565419	8798-70	28	70	30.0	151.0	75	2900
1565427	8798-75	28	75	31.5	163.0	100	4000
1565435	8798-80	28	80	34.5	174.0	100	4400
1565443	8798-85	28	85	34.5	174.0	100	4300
1565451	8798-90	28	90	39.0	195.0	100	5400
1565478	8798-95	28	95	39.0	195.0	100	5100
1565486	8798-100	28	100	47.0	227.0	100	7600

8794

RATCHET HEAD 28 Z

- For accessing bolts in cramped and hard-to-reach locations, easy to change
- Chrome-vanadium steel, matt chrome-plated
- With catch retention
- Max. continuous load of coupler according to DIN EN ISO 6789:2003 and/or maximum support load
- 8794-05 3/4" = 1000 N-m

28



20

3/4



Code	No.	Ø	Type	■"	■	Depth gauge	↕
1566032	8794-05	28	●	3/4	20	75	1800



DREMOMETER Z



246



TORCOFIX Z



254





END FITTINGS 9X12 SE

7112

RECTANGULAR OPEN END FITTING 9x12

- For accessing bolts in cramped and hard-to-reach locations, easy to change
- Forged
- Chrome-vanadium steel, chrome-plated
- With eject-pin for unlocking



Code	No.	□mm	○mm	mm ^{1/2}	○mm	Depth gauge	↕
7688390	7112-07	9 x 12	7	5.0	22.0	17.5	35
7688550	7112-08	9 x 12	8	5.0	22.0	17.5	35
7679050	7112-09	9 x 12	9	5.5	26.0	17.5	35
7688630	7112-10	9 x 12	10	5.5	26.0	17.5	40
7688980	7112-11	9 x 12	11	5.5	26.0	17.5	30
7679560	7112-12	9 x 12	12	7.0	30.0	17.5	35
7689010	7112-13	9 x 12	13	7.0	30.0	17.5	35
7689360	7112-14	9 x 12	14	8.0	35.0	17.5	40
7689440	7112-15	9 x 12	15	8.0	35.0	17.5	40
7679990	7112-16	9 x 12	16	8.5	38.0	20.0	45
7689600	7112-17	9 x 12	17	8.5	38.0	20.0	50
7684560	7112-18	9 x 12	18	9.0	42.0	20.0	60
7689790	7112-19	9 x 12	19	9.0	42.0	20.0	60

7312

RECTANGULAR FLARED END FITTING 9x12

- For accessing bolts in cramped and hard-to-reach locations, easy to change
- Forged
- Chrome-vanadium steel, chrome-plated
- With eject-pin for unlocking



Code	No.	□mm	○mm	mm ^{1/2}	○mm	Depth gauge	Opening width	↕
7685290	7312-10	9 x 12	10	12.0	22.0	17.5	7.0	40
7685370	7312-11	9 x 12	11	12.0	22.5	17.5	8.5	40
7699590	7312-12	9 x 12	12	12.0	23.7	17.5	9.0	40
7679210	7312-13	9 x 12	13	12.0	25.2	17.5	10.0	40
7679480	7312-14	9 x 12	14	12.0	27.0	17.5	11.2	50
7685880	7312-17	9 x 12	17	13.0	31.5	17.5	14.0	65
7679640	7312-18	9 x 12	18	15.0	33.0	17.5	14.5	65
7686260	7312-19	9 x 12	19	15.0	34.5	17.5	15.0	65
7679720	7312-22	9 x 12	22	15.0	39.0	20.0	17.0	65

7412

RECTANGULAR REVERSIBLE RATCHET HEAD 9x12

- For accessing bolts in cramped and hard-to-reach locations, easy to change
- Forged
- Chrome-vanadium steel, matt chrome-plated
- With eject-pin for unlocking
- Fine-toothed
- Return angle 7°
- Max. continuous load of coupler according to DIN EN ISO 6789:2003 and/or maximum support load
 - 741200 1/4" = 30 N-m
 - 7412-01 3/8" = 135 N-m
 - 7412-02 1/2" = 150 N-m

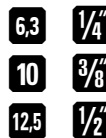

Code	No.	□mm	∠°	■"	■mm	mm ^{1/2}	○mm	Depth gauge	↕
7672710	7412-00	9 x 12	16	1/4	6.3	14.0	22.0	17.5	60
7686500	7412-01	9 x 12	5	3/8	10.0	24.0	33.0	17.5	140
7687230	7412-02	9 x 12	5	1/2	12.5	28.3	33.0	17.5	150

7212

RECTANGULAR RING END FITTING 9x12

- For accessing bolts in cramped and hard-to-reach locations, easy to change
- Forged
- Chrome-vanadium steel, chrome-plated
- With eject-pin for unlocking



Code	No.	□mm	○mm	mm ^{1/2}	○mm	Depth gauge	↕
7691340	7212-07	9 x 12	7	8.0	13.0	17.5	30
7691420	7212-08	9 x 12	8	8.0	14.2	17.5	30
7691690	7212-10	9 x 12	10	9.0	17.2	17.5	30
7691770	7212-11	9 x 12	11	9.0	18.5	17.5	30
7677940	7212-12	9 x 12	12	12.0	20.0	17.5	35
7691930	7212-13	9 x 12	13	12.0	21.5	17.5	35
7692230	7212-14	9 x 12	14	12.0	23.0	17.5	40
7692580	7212-15	9 x 12	15	12.0	24.2	17.5	40
7678080	7212-16	9 x 12	16	13.0	25.7	17.5	40
7692740	7212-17	9 x 12	17	13.0	27.0	17.5	40
7678160	7212-18	9 x 12	18	13.0	28.5	17.5	40
7692820	7212-19	9 x 12	19	13.0	30.3	17.5	40
7678240	7212-21	9 x 12	21	15.0	33.0	17.5	50
7693040	7212-22	9 x 12	22	15.0	34.5	17.5	50

7612

RECTANGULAR FIXED SQUARE HEAD 9x12

- For accessing bolts in cramped and hard-to-reach locations, easy to change
- Forged
- Chrome-vanadium steel, matt chrome-plated
- With eject-pin for unlocking
- Max. continuous load of coupler according to DIN EN ISO 6789:2003 and/or maximum support load
 - 761200 1/4" = 30 N-m
 - 7612-01 3/8" = 135 N-m
 - 7612-02 1/2" = 150 N-m



Code	No.	□mm	■"	■mm	mm ^{1/2}	○mm	Depth gauge	↕
7672630	7612-00	9 x 12	1/4	6.3	14.0	20.0	17.5	70
7679800	7612-01	9 x 12	3/8	10.0	14.0	22.0	17.5	70
7687900	7612-02	9 x 12	1/2	12.5	14.0	22.0	17.5	80

7812

RECTANGULAR BIT HOLDER 9x12

- For accessing bolts in cramped and hard-to-reach locations, easy to change
- Forged
- Chrome-vanadium steel, chrome-plated
- With eject-pin for unlocking



Code	No.	□mm	●"	●mm	mm ^{1/2}	○mm	Depth gauge	↕
7697970	7812-00	9 x 12	5/16	8.0	12.5	16.0	17.5	40
2101645	7812-10	9 x 12	1/4	6.3				40

7912

RECTANGULAR WELD-ON FITTING 9x12

- For accessing bolts in cramped and hard-to-reach locations, easy to change
- Bear the depth gauges in mind



Code	No.	□mm	□mm	mm ^{1/2}	○mm	Depth gauge	↕
7698190	7912-00	9 x 12	14	14	8	8	30



END FITTINGS 14X18 SE

7118

RECTANGULAR OPEN END FITTING 14x18

- For accessing bolts in cramped and hard-to-reach locations, easy to change
- Forged
- Chrome-vanadium steel, chrome-plated
- With eject-pin for unlocking

14x18



Code	No.	□mm	○mm	mm ^{1/2} ▷	□mm	Depth gauge	↕
7689870	7118-13	14 x 18	13	7.0	30.0	25.0	120
7690020	7118-14	14 x 18	14	8.0	35.0	25.0	120
7690100	7118-15	14 x 18	15	8.0	35.0	25.0	120
7685610	7118-16	14 x 18	16	9.0	38.0	25.0	125
7690370	7118-17	14 x 18	17	9.0	38.0	25.0	130
7686180	7118-18	14 x 18	18	10.0	42.0	25.0	130
7690450	7118-19	14 x 18	19	10.0	42.0	25.0	130
7686420	7118-21	14 x 18	21	11.0	50.0	25.0	155
7690610	7118-22	14 x 18	22	11.0	50.0	25.0	150
7690880	7118-24	14 x 18	24	12.0	53.0	25.0	170
7690960	7118-27	14 x 18	27	13.0	60.0	30.0	185
2212285	7118-29	14 x 18	29	14.0	63.0	30.0	220
7691260	7118-30	14 x 18	30	14.0	66.0	30.0	220
7687740	7118-32	14 x 18	32	14.0	66.0	32.5	220
1963708	7118-34	14 x 18	34	15.0	74.0	32.5	255
1963716	7118-36	14 x 18	36	15.0	78.0	35.0	257
1963724	7118-41	14 x 18	41	15.0	82.0	40.0	261

7218

RECTANGULAR RING END FITTING 14x18

- For accessing bolts in cramped and hard-to-reach locations, easy to change
- Forged
- Chrome-vanadium steel, chrome-plated
- With eject-pin for unlocking

14x18



Code	No.	□mm	○mm	mm ^{1/2} ▷	□mm	Depth gauge	↕
7693120	7218-13	14 x 18	13	11.0	21.5	25.0	120
7693390	7218-14	14 x 18	14	11.0	23.0	25.0	120
7693470	7218-15	14 x 18	15	11.0	24.2	25.0	115
7678320	7218-16	14 x 18	16	12.0	25.7	25.0	125
7693630	7218-17	14 x 18	17	12.0	27.2	25.0	125
7678830	7218-18	14 x 18	18	12.0	28.5	25.0	125
7693710	7218-19	14 x 18	19	12.0	30.5	25.0	125
7678910	7218-21	14 x 18	21	15.0	33.0	25.0	140
7693980	7218-22	14 x 18	22	15.0	34.5	25.0	140
7694280	7218-24	14 x 18	24	15.0	37.5	25.0	140
7694440	7218-27	14 x 18	27	17.0	41.5	25.0	150
7694790	7218-30	14 x 18	30	19.0	45.0	25.0	160
7695920	7218-32	14 x 18	32	19.0	47.5	25.0	165
7679130	7218-34	14 x 18	34	19.0	50.5	28.0	195
7696220	7218-36	14 x 18	36	19.0	53.0	28.0	195
7696300	7218-41	14 x 18	41	20.0	59.0	30.0	225

7418

RECTANGULAR REVERSIBLE RATCHET HEAD 14x18

- For accessing bolts in cramped and hard-to-reach locations, easy to change
- Forged
- Chrome-vanadium steel, matt chrome-plated
- With eject-pin for unlocking
- Fine-toothed
- Return angle 7°
- Max. continuous load of coupler according to DIN EN ISO 6789:2003 and/or maximum support load
- 7418-02 1/2" = 340 N-m
- 7418-04 3/4" = 400 N-m

14x18



12,5 1/2"

20 3/4"



Code	No.	□mm	■"	■	mm ^{1/2} ▷	□mm	Depth gauge	↕
7687580	7418-02	14 x 18	1/2	12.5	7,2	26.2	43.0	25.0 350
7687660	7418-04	14 x 18	3/4	20.0	7,2	30.7	50.0	33.0 780

7618

RECTANGULAR FIXED SQUARE HEAD 14x18

- For accessing bolts in cramped and hard-to-reach locations, easy to change
- Forged
- Chrome-vanadium steel, matt chrome-plated
- With eject pin for unlocking
- Max. continuous load of coupler according to DIN EN ISO 6789:2003 and/or maximum support load
- 7618-02 1/2" = 340 N-m
- 7618-04 3/4" = 400 N-m

14x18



12,5 1/2"

20 3/4"



Code	No.	□mm	■"	■	mm ^{1/2} ▷	□mm	Depth gauge	↕
7688040	7618-02	14 x 18	1/2	12.5	18.0	30.0	25.0	200
7688200	7618-04	14 x 18	3/4	20.0	25.0	40.0	25.0	390

7818

RECTANGULAR BIT HOLDER 14x18

- For accessing bolts in cramped and hard-to-reach locations, easy to change
- Forged
- Chrome-vanadium steel, chrome-plated
- With eject-pin for unlocking

14x18



8

5/16"



Code	No.	□mm	●"	●	mm ^{1/2} ▷	□mm	Depth gauge	↕
7698000	7818-00	14 x 18	5/16	8	12.5	16.0	25.0	100

7918

RECTANGULAR WELD-ON FITTING 14x18

- For accessing bolts in cramped and hard-to-reach locations, easy to change
- Bear the depth gauges in mind

14x18



Code	No.	□mm	□mm	mm ^{1/2} ▷	□mm	Depth gauge	↕
7698430	7918-00	14 x 18	25	21.5	11.0	12.0	100



DREMOMETER SE / TORCOFIX SE



249
256



++ DREMOPLUS

HAND TORQUE MULTIPLIERS. EFFORTLESSLY ACHIEVE SUPREME TORQUE VALUES IN A VERY SMALL SPACE.



Actio = Reactio: Reaction arm for the absorption of the reaction.

Drive: Input square of sizes 3/8", 1/2" and 3/4".

Maximum precision: Smoothed tooth flanks, honed drill holes, hardened cylindrical pins and precision bearings ensure that frictional losses in the planet gear are kept negligible. Accuracies of +/- 4% over the entire working range provide the optimum safety when making screw connections.

Torque reaction: Sliding reaction "slave" square can be supported on an adjacent screw with a impact nut socket, e.g. in the case of flange screw connections.

Solid and robust: Housing made of quality steel. Also designed for strong forces. The compact construction enables work on hard-to-access screw connections.

Safety: Torque multipliers starting from a ratio of 1:5 are fitted with anti-wind-up ratchets.

Flexible: Replaceable reaction plate for individual requirements.



++ ADVANTAGES OF A TORQUE MULTIPLIER

- ▶ Avoidance of long levers - meaning that you work more safely
- ▶ The specified ratio is the true torque multiplication factor
- ▶ You can manage without correction charts for determining the output torque
- ▶ Models having an anti-wind-up ratchet enable you to work more safely
- ▶ For high-precision torque control, electronic torque transducers are available for all models.

++ 1:22
1000 N-m

+ 1:5 - 1:26
1300-4500 N-m

+ 1:5
1300-2700 N-m

++ 1:5 - 1:125
1700-3400 N-m

+ 1:5 - 1:125
6000-47500 N-m

+ 1:5 - 1:25
1000-1500 N-m

++ 1:5 - 1:125
2700-6000 N-m





i GEARBOX ELEMENTS

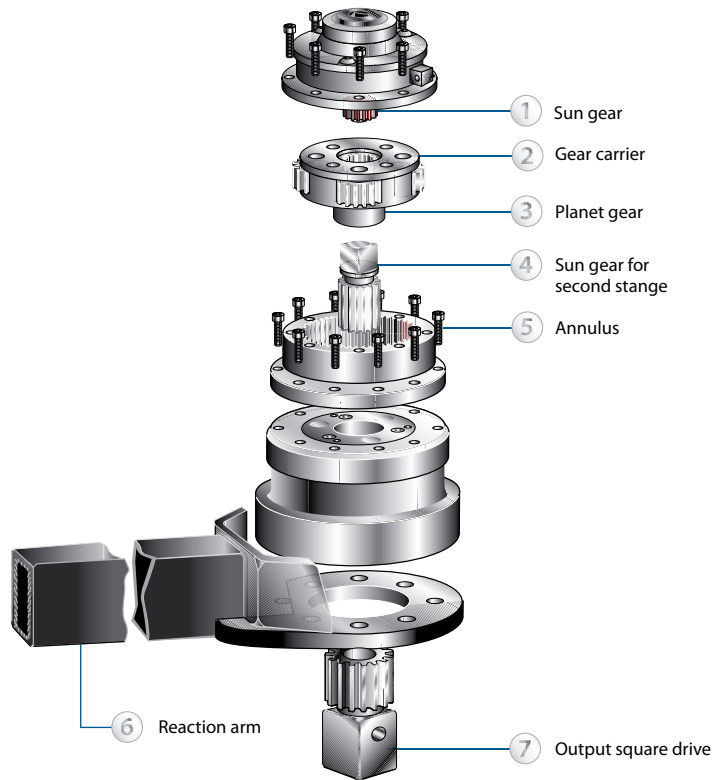

i SAFELY OPERABLE

Torque
Reactions

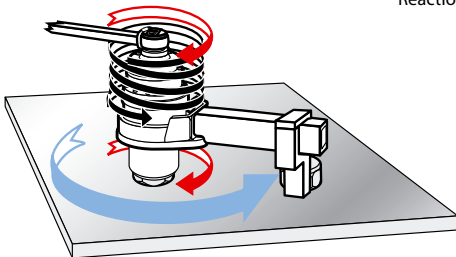

The gearbox wind-up forces and torsion wind-up forces must build up like in the case of a "spring"!

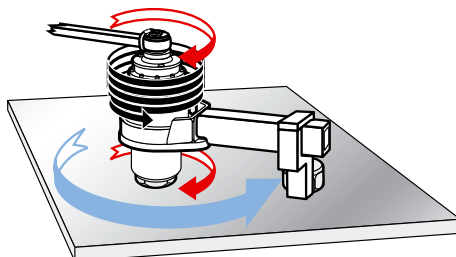

Multiplier will achieve maximum torque only after the "spring" has been taken up.

Important remark on safety: When used upside down, an additional support is strongly recommended. If the screw connection breaks or the torque multiplier releases its torsion wind-up forces, the device could fall out on the user.

i WORKING PRINCIPLE

Torque
Velocity

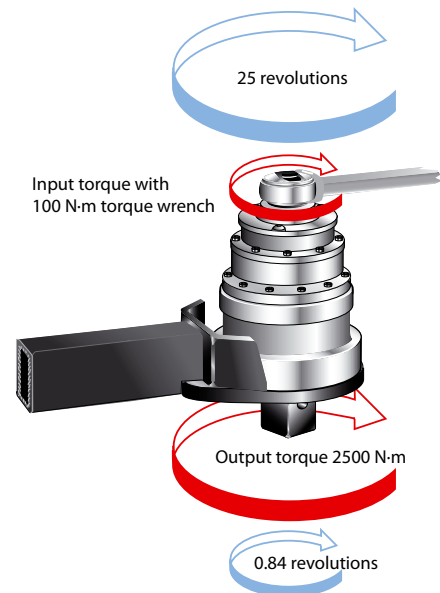

The representation shown in the chart is intended for elucidating the principle of torque multiplication. Let us assume an input torque of 100 N-m and an output torque of 2500 N-m. In the case of a ratio of e.g. 1:25, 25 revolutions are required on the input in order to achieve approx. 1 revolution with a torque of 2,500 N-m on the output. This is substantiated in terms of the physical formula: Power = torque x velocity (r.p.m.)

Because we must regard the input and output powers as constant, the multiplication of the torque can only be accomplished through an increased number of revolutions at the input. A torque wrench with a ratchet head function makes it easier for the user to quickly obtain the necessary rotary speeds.



8600

UNIVERSAL TORQUE MULTIPLIER DREMOPLUS 1300-2700 N-m / 960-2000 lbf-ft

Use:

- ✔ Industry, construction sites, industrial-vehicle and automobile garages
- ✔ Bridge-, ship-building, aircraft and railway construction, refineries

Features:

- ✔ Mechanical, hand torque multiplier for controlled screw tightening
- ✔ With single-stage precision planet gear
- ✔ Housing and torque reaction made of quality steel
- ✔ Multiplication at the ratio of 1:5, effective
- ✔ With overload protection for protecting the gearbox
- ✔ With 2 reaction devices
- ✔ Guaranteed accuracy: Better than +/- 4% tolerance
- ✔ For operation in combination with a torque wrench
- ✔ 2 models for a maximum load of 1300 N-m or 2700 N-m
- ✔ Model 8600-11 output square drive with ball - for sockets with ball-locking mechanism
- ✔ Model 8600-20 output square drive with drill hole - for sockets or, better still, impact sockets with a safety pin and ring
- ✔ Model 8600-11 is optionally available as a set no. 8600-10 with accessories

Scope of delivery:

- ✔ Torque multiplier
- ✔ Plug-in reaction bar no. 8600-01 and plug-in reaction foot no. 8600-03
- ✔ Model 8600-11 with a 3/4" spare square drive no. 8600-02
- ✔ Delivered in an extremely sturdy plastic case (red case (no. 8600-99) = type 8600-10/-11 and a black case (no. 8600-98) = type 8600-20
- ✔ Additional component parts of the set no. 8600-10 include 2 impact sockets 27 and 32 mm
- ✔ Detailed technical information is available on request

20
3/4"
25
1"

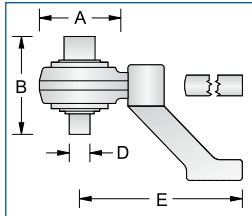

Code	No.	Contents	⚙ max. N-m-Output	⚙ max. lbf-ft-Output	⚙ 1:5	□ °C 1/2	■ °D 3/4	A	B	E _{min}	E _{max}	⚙ max. N-m-Input	⚙ max. lbf-ft-Input	
7715110	8600-11	8600-11 8600-01 8600-02 8600-03	1300	960	1:5	1/2	3/4	108	126	210	340	4.2	260	192
7715030	8600-10	8600-11 8600-01 8600-02 8600-03 K 32 27 K 32 32	1300	960	1:5	1/2	3/4	108	126	210	340	6.9	260	192
7692150	8600-20	8600-20 8600-01 8600-03	2700	2000	1:5	3/4	1	108	128	210	340	4.3	540	400

Code	No.	Description	⚙ max.
1193554	8600-01	Reaction bar for no. 8600 and 8608-01/-02	1050
7622370	8600-02	Spare square drive for no. 8600-10/-11	120
1193562	8600-03	Reaction foot for no. 8600 and 8608-01/-02	1400
1501593	8600-98	Black case, empty - for no. 8600-20	944
7622450	8600-99	Blue case, empty - for no. 8600-10/-11	944





8608

TORQUE MULTIPLIER DREMOPLUS 1300-4500 N-m / 960-3300 lbf-ft

Use:

- Industry, construction sites, industrial vehicles and automobile garages
- Bridge-, ship-building, aircraft and railway construction, refineries

Features:

- Mechanical, hand torque multiplier for controlled screw tightening
- With a single-stage precision planet gear
- Housing made of quality steel, chrome-plated with black cover caps
- Multiplication at a ratio 1:5, 1:15.5 or 1:26, effective
- Models 8608-03/-04 with anti-wind-up ratchet (AWUR) and angular disc for additional angular tightening
- With overload protection for protecting the gearbox
- With model-dependent reaction device
- Guaranteed accuracy: Better than +/- 4% tolerance
- For operation in combination with a torque wrench
- 4 models for maximum load in the range between max. 1300 N-m and max. 4500 N-m
- Output square drive with a drill hole - for sockets or, better still, impact sockets with a safety pin and ring

Scope of delivery:

- Torque multiplier
- With reaction device - model-dependent:
- No. 8608-01/-02 with plug-in reaction bar
- No. 8608-03 RS/-04 RS with plug-in reaction tube (chrome-plated)
- Delivered in a solid black plastic case with inlay (no. 8608-90 = type 8608-01/-02 and no. 8608-91 = type 8608-03/-04)
- Detailed technical information is available on request

20
3/4"
25
1"



Code	No.	max. N-m-Output	max. lbf-ft-Output	Ratio	□ °C	■ °D	A	B	E	Weight	max. N-m-Input	max. lbf-ft-Input
1471678	8608-01	1300	960	1:5	1/2	3/4	108	126	210	4.2	260	192
1471651	8608-02	2700	2000	1:5	3/4	1	108	128	210	4.3	540	400
1471635	8608-03 RS	3000	2200	1:15,5	1/2	1	108	156	450	8.0	193	142
1471627	8608-04 RS	4500	3300	1:26	1/2	1	108	173	450	8.9	173	127

Code	No.	Description	Weight
1193554	8600-01	Reaction bar for no. 8600 and 8608-01/-02	1050
1193562	8600-03	Reaction foot for no. 8600 and 8608-01/-02	1400
1471643	8608-90	Plastic case, empty for 8608-01/-02	1000
1471619	8608-91	Plastic case, empty for 8608-03/-04	1400
1526359	8608-92	Spare square drive 3/4" for 8608-01	106
1526367	8608-93	Spare square drive 1" for 8608-02	890
1526383	8608-94	Spare square drive 1" for 8608-03	249
1526391	8608-95	Spare square drive 1" for 8608-04	250
1526405	8608-96	Reaction bar for 8608-03/-04	1830

K 20

211

754

244

AM-F

240 - 241



8601 - 8607

TORQUE MULTIPLIER DREMOPLUS 1700-47500 N-m / 1250-35000 lbf-ft

Use:

- Heavy industry, construction sites
- Bridge-, ship-building, aircraft and railway construction, refineries

Features:

- Mechanical hand torque multiplier for controlled screw tightening
- With single-stage or multistage precision planet gear
- Housing and torque reaction made of quality steel
- Multiplication at the ratio 1:5, 1:25 or 1:125, effective
- Models starting from a ratio of 1:25 with anti-wind-up ratchet (AWUR)
- With overload protection for protecting the gearbox
- With model-dependent reaction plate/reaction device
- Guaranteed accuracy: Better than +/- 4% tolerance
- For operation in combination with a torque wrench
- 7 models for maximum load in the range between max. 1700 N-m and max. 3400 N-m
- Output square drive with drill hole - for sockets or, better still, impact sockets with a safety pin and ring

Scope of delivery:

- Torque multiplier
- With reaction plate/reaction device, model-dependent:
 - No. 8601-11 to 8602-23 RS with reaction plate and sliding reaction "slave" spigot end for 1" sockets
 - No. 8603-31 to 8603-35 RS with a reaction plate and a sliding reaction "slave" square for 1.1/2" impact sockets
- Delivered in sturdy cardboard packaging
- Detailed technical information is available on request

- 25
- 1"
- 40
- 1 1/2"
- 63
- 2 1/2"

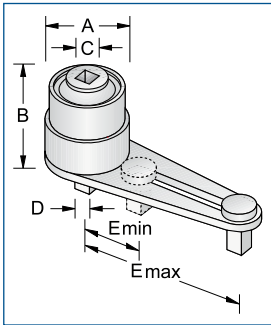

Code	No.	max. N-m-Output	max. lbf-ft-Output	••	□ °C	■ °D	A	B	E _{min}	E _{max}	⚙	max. N-m-Input	max. lbf-ft-Input
7701240	8601-11	1700	1250	1:5	3/4	1	108	126	83	217	4.8	340	250
7703450	8601-13 RS	1700	1250	1:25	1/2	1	108	156	83	217	6.5	68	50
7701400	8602-21	2700	2000	1:5	3/4	1	119	143	86	264	7.2	540	400
7703290	8602-23 RS	2700	2000	1:25	1/2	1	119	187	86	264	10.0	108	80
7701670	8603-31	3400	2500	1:5	3/4	1.1/2	119	149	86	264	8.7	680	500
7704420	8603-34 RS	3400	2500	1:25	1/2	1.1/2	119	195	86	264	10.5	136	100
7704500	8603-35 RS	3400	2500	1:125	1/2	1.1/2	119	220	86	264	11.5	27	20
7701910	8604-44	6000	4500	1:5	3/4	1.1/2	144	165	146	333	13.6	1200	900
7702050	8604-45 RS	6000	4500	1:25	1/2	1.1/2	144	226	146	333	16.5	240	180
7702130	8604-46 RS	6000	4500	1:125	1/2	1.1/2	144	234	146	333	18.0	48	36
7702640	8605-53 RS	20000	14700	1:125	1/2	2.1/2	212	307		500	40.4	160	118
7702210	8605-62 RS	9500	7000	1:25	3/4	1.1/2	184	209	171	351	21.0	380	280
7702480	8605-63 RS	9500	7000	1:125	1/2	1.1/2	184	234	171	351	27.0	76	56
7702720	8607-73 RS	47500	35000	1:125	3/4	2.1/2	315	366			94.8	380	280

➔ **920 922**

 **487**



➔ **TORCOFIX K**

 **252**



➔ **DREMOMETER / 754**

 **241**
244





8613

MINI TORQUE MULTIPLIER DREMOPLUS max. 1000 N-m / 738 lbf-ft

- ✔ Guaranteed accuracy: better than +/- 4% tolerance
- ✔ Torque multiplication ratio: 22:1
- ✔ For operation in combination with a torque wrench
- ✔ With reaction arm
- ✔ RS = with anti-wind-up ratchet (AWUR)



20
3/4"

Code	No.	max. N-m-Output	max. lbf-ft-Output	••	□ *E	■ *F	⚙	max. N-m-Input	max. lbf-ft-Input
1820044	8613-01	1000	738	1:22	3/8	3/4	2.3	45	34
1820052	8613-02	1000	738	1:22	1/2	3/4	2.3	45	34
1824597	8613-03 RS	1000	738	1:22	3/8	3/4	2.5	45	34
1824600	8613-04 RS	1000	738	1:22	1/2	3/4	2.5	45	34



8615 - 8660

TORQUE MULTIPLIER DREMOPLUS COMPACT 1000-6000 N-m / 750-4400 lbf-ft

Use:

- ✔ Heavy industry, steel construction
- ✔ Bridge- and ship-building, aircraft and railway construction, refineries

Features:

- ✔ Mechanical, hand torque multiplier for controlled screw tightening
- ✔ With single-stage or multistage precision planet gear
- ✔ Housing and torque reaction made of quality steel
- ✔ Multiplication at the ratio of 1:5, 1:25, 1:75 or 1:125 effective
- ✔ Models with a torque multiplication ratio of 25:1 and above with anti-wind-up ratchet (AWUR)
- ✔ With overload protection for protecting the gearbox
- ✔ With model-dependent reaction plate / reaction device, alternative reaction devices on request
- ✔ Guaranteed accuracy: Better than +/- 4% tolerance
- ✔ For operation in combination with a torque wrench
- ✔ 9 models for maximum load in the range between max. 1000 N-m and max. 2700 N-m
- ✔ Output square drive with drill hole - for sockets or, better still, impact sockets with a safety pin and ring

Scope of delivery:

- ✔ Torque multiplier
- ✔ With reaction plate/reaction device, model-dependent:
- ✔ nos. 8615-01 to 8615-06 RS with short reaction plate
- ✔ no. 8630-01 RS with angled support arm
- ✔ Delivered in sturdy cardboard packaging
- ✔ Detailed technical information is available on request



20
3/4"
25
1"
40
1 1/2"



Code	No.	Description	⚙
1545175	8615-96	Reaction plate short (without adaptor plate) for 8615	900
1545183	8615-97	Reaction plate straight for 8615	2550
1545191	8630-96	Cranked reaction arm for 8630	2000
1545205	8630-97	Reaction plate straight for 8630	2470
1545213	8660-96	Cranked reaction arm for 8660	4150
1545221	8660-97	Reaction plate straight for 8660	2470

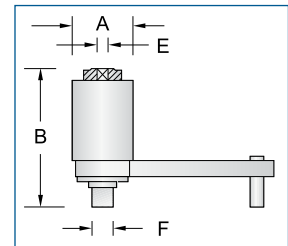
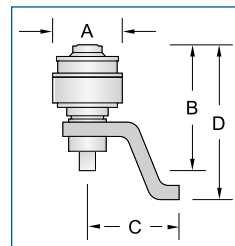

Code	No.	max. N-m-Output	max. lbf-ft-Output	••	□ *E	■ *F	A	B	⚙	max. N-m-Input	max. lbf-ft-Input
7697620	8615-01	1000	750	1:5	1/2	3/4	72	144	4.8	200	150
7697700	8615-02	1000	750	1:5	3/4	3/4	72	144	4.8	200	150
7697890	8615-03 RS	1000	750	1:25	1/2	3/4	72	166	5.8	40	30
7699670	8615-04	1500	1100	1:5	1/2	1	72	144	4.8	300	220
7699750	8615-05	1500	1100	1:5	3/4	1	72	144	4.8	300	220
7699830	8615-06 RS	1500	1100	1:25	1/2	1	72	166	5.8	60	44
7699910	8630-01 RS	2700	2000	1:5	3/4	1	108	196	8.0	540	400
7681030	8630-02 RS	2700	2000	1:15	1/2	1	108	224	9.0	180	133
7681110	8630-03 RS	2700	2000	1:25	1/2	1	108	224	9.0	108	80
7683080	8660-01 RS	6000	4400	1:25	1/2	1.1/2	119	271	15.0	240	176
7684800	8660-02 RS	6000	4400	1:75	1/2	1.1/2	119	301	16.5	80	59
7685020	8660-03 RS	6000	4400	1:125	1/2	1.1/2	119	301	16.5	48	35



++ ELECTRONIC TORQUE WRENCHES TORCOTRONIC

TORCOTRONIC II

Extremely simple to operate on account of the 3 multifunction keys

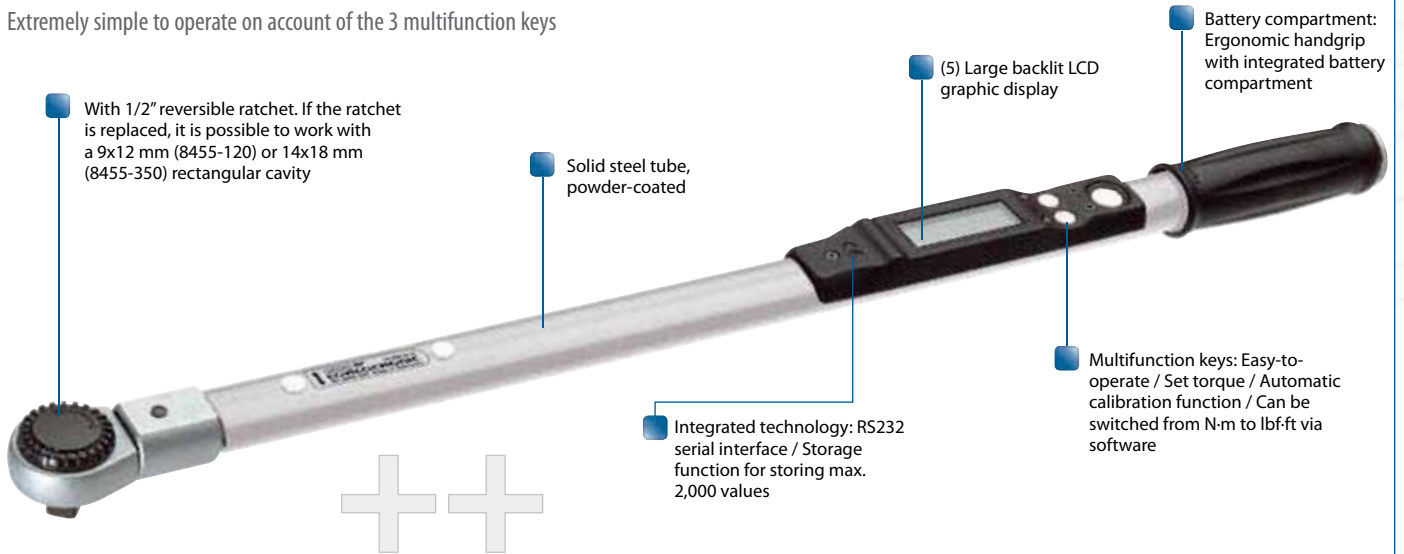

With 1/2" reversible ratchet. If the ratchet is replaced, it is possible to work with a 9x12 mm (8455-120) or 14x18 mm (8455-350) rectangular cavity

Solid steel tube, powder-coated

(5) Large backlit LCD graphic display

Battery compartment: Ergonomic handgrip with integrated battery compartment

Integrated technology: RS232 serial interface / Storage function for storing max. 2,000 values

Multifunction keys: Easy-to-operate / Set torque / Automatic calibration function / Can be switched from N-m to lbf-ft via software

8455

ELECTRONIC TORQUE WRENCH TORCOTRONIC II 10-350 N-m / 7.4-258.2 lbf-ft

Use:

- For everyday requirements in installation and torque control
- For use in all areas of manufacturing and development

Execution:

- Microprocessor-controlled, electronic torque wrench
- For controlled bi-directional tightening
- Acc. to DIN EN ISO 6789, traceable to national standards
- Robust industrial design
- Broad measurement range in N-m, can be switched to lbf-ft
- High measurement accuracy: +/- 1% tolerance for all read-off values, +/- 1 digit
- With 1/2" reversible ratchet. The ratchet is exchangeable, providing the option of using a 9x12 mm (8455-120) or 14x18 mm (8455-350) square socket

Features:

- Large illuminated graphic LCD display
- Icon-menu navigation easy to understand
- Simple operation with 3 multifunction buttons
- Extra large, easy reachable button near the handgrip
- 2000 storage places
- Track- / Peak-Mode as well as 5 pre-set modes storable
- Different depth gauges for end fittings programmable
- Automatic calibration at the push of a button and following standby mode
- Keyboard lock
- Serial interface RS232
- PC-software easy to operate for uncomplicated programming and documentation of data
- Data can be transferred to MS Excel®
- 2 models in the range 10 - 350 N-m



Scope of delivery:

- Electronic torque wrench TorcoTronic
- Reversible ratchet 1/2"
- Test certificate acc. to DIN EN ISO 6789 Type I Class B
- Delivered in cardboard packaging with black foam module insert
- Cable for serial interface RS232
- Software on CD-R

Attention:

- A PC, running a Windows® operating system (from Windows 2000®) is required to obtain the full benefit of all the functions of this product

Code	No.	■"	■	□mm	N-m	lbf-ft	↔
1932136	8455-120	1/2	12.5	9 x 12	10-120	7,4-88,5	0.9
1932144	8455-350	1/2	12.5	14 x 18	70-350	51,6-258,2	1.3

E-TORC II MICROPROCESSOR-CONTROLLED TORQUE WRENCH

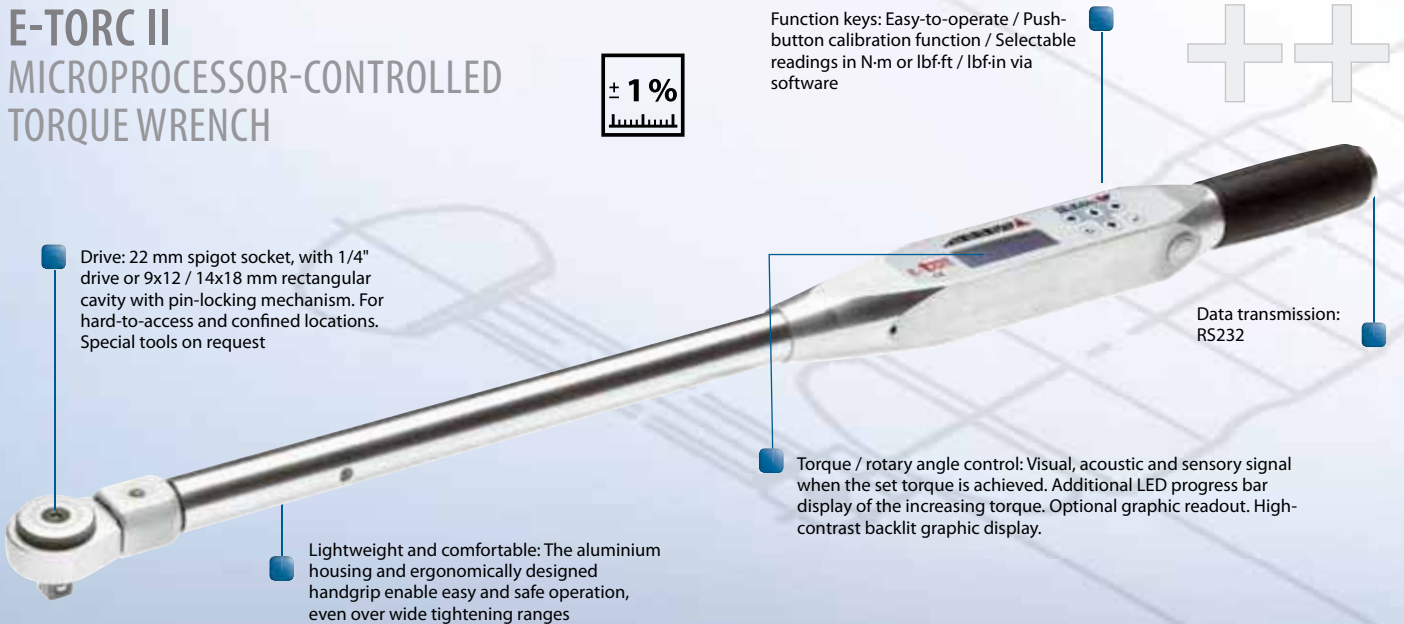

Drive: 22 mm spigot socket, with 1/4" drive or 9x12 / 14x18 mm rectangular cavity with pin-locking mechanism. For hard-to-access and confined locations. Special tools on request

Lightweight and comfortable: The aluminium housing and ergonomically designed handgrip enable easy and safe operation, even over wide tightening ranges

± 1%

Function keys: Easy-to-operate / Push-button calibration function / Selectable readings in N-m or lbf-ft / lbf-in via software

Data transmission: RS232

Torque / rotary angle control: Visual, acoustic and sensory signal when the set torque is achieved. Additional LED progress bar display of the increasing torque. Optional graphic readout. High-contrast backlit graphic display.



TORQUE CALIBRATION ANALYSER

8612

ELECTRONIC TORQUE TESTER DREMOTEST E 0.2-1100 N-m / 1.8 lbf-in - 811 lbf-ft

- For verifying and setting clockwise torque wrenches and torque screwdrivers in the range from 0.1 - 1100 N-m
- Simple, electronic torque tester with integrated torque transducer (DMS)
- With fixed hexagon female drive 1/4", 10, 17, 36 mm (model dependent)
- With 1/4", 3/8", 1/2" and 3/4" square drive adaptor or bit adaptor (model dependent)
- High measurement accuracy: +/- 1% tolerance of reading, +/- 1 digit
- Break-Point-measurement (1st peak)
- Autoreset
- Can be switched from N-m to lbf-ft
- Serial interface RS232
- Optionally available: adaptor for cigarette lighter socket (12 V), no. 8612-390

-
-
-
-
-
-
-
-

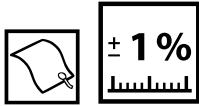

Code	No.	Ø	N-m	lbf-in	lbf-ft	Adaptor	⚙️
2288311	8612-012	6.3	0,2-12	1,8-106		1/4", 3/8"	3.0
1947699	8612-050	10.0	0,9-55		0,7-40,6	1/4", 3/8"	3.0
1856111	8612-300	17.0	9-320		7-236	3/8", 1/2"	3.0
1947702	8612-1000	36.0	90-1100		66-811	1/2", 3/4"	10.0
1878719	8612-390						0.2

8612

TORQUE CALIBRATION ANALYSER DREMOTEST 0-25 N-m / 0-220 lbf-in

- Features:**
- Guaranteed measuring accuracy: +/- 2% of read-out in the core range of 20 - 100 % of the scale
 - Dual scale in cN-m and ozf-in or N-m and lbf-in
 - Model no. 8612-700 suitable for clockwise and counter-clockwise calibration, all other models for clockwise tightening
 - For testing and setting clockwise torque wrenches and screwdrivers in the lower torque range of 0 - 25 N-m

-
-
-
-
-
-

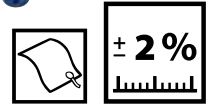

Code	No.	Scale cN-m / N-m	Scale ozf-in / lbf-in	Adaptor	⚙️
1824619	8612-700	0-10 cN-m	0-14 ozf-in		1.0
1824627	8612-710	7-35 cN-m	10-50 ozf-in		1.7
1824635	8612-720	26-130 cN-m	36-180 ozf-in		1.7
1824643	8612-730	0,8-4,0 N-m	7-36 lbf-in		1.7
1824651	8612-740	2,4-12 N-m	24-120 lbf-in		1.7
1824678	8612-750	5-25 N-m	44-220 lbf-in		1.8





ELECTRONIC TORSIONS TORQUE TESTER E-TP

The smart electronic torque tester series with the new torsion metrology 0.5-3150 N·m



✔ The smart and modular system of the E-tp which is made possible by keeping separate the measuring and display instrument, convinces and offers the user an ideal measuring environment in any kind of operation. Depending on use, the display unit can easily be taken out and placed in another position, to enable the user to always have the display in optimal view.

Your advantage:

✔ In all applications the operating display is always in the direct field of vision and near to the operator. With the new E-tp you can avoid complicated and impractical measuring operations caused by a bad visibility of the display from a distance which is often the case at standard torque testers with a fixed display.

✔ The E-tp tester enables a precise and comfortable operation, verifying and calibrating of all clockwise and anti-clockwise torque wrenches in the range of 0.5-3150 N·m. The torsion metrology, located in the robust aluminium housing, allows the user a horizontal as well as a vertical torque operation complying with standards (DIN EN ISO 6789).

Your advantage:

✔ With one E-tp torque tester only, bi-directional torque wrenches can be tested and calibrated in the horizontal or vertical plane.

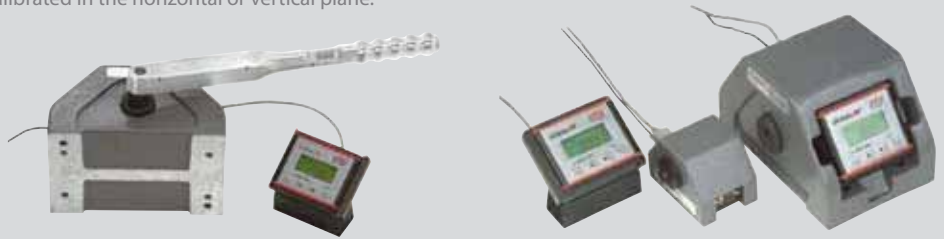

EMPTY STANDARD PACKAGING

PLASTIC CASSETTES EMPTY FOR DREMOMETER MINI + AM

Use:

✔ Standard packaging for sets of the torque wrench series DREMOMETER MINI and AM

✔ Robust and solid, best for storage and transport

Inclusion:

✔ Solid, black plastic cassette

✔ For torque wrench series DREMOMETER MINI and AM

✔ With foam rubber inlay and nest-holes for the accessories

Scope of delivery:

✔ Plastic cassettes with foam inlay only

✔ Delivery in sturdy cardboard packaging



Code	No.	Description	L	W	H	±
1986805	753-88	Plastic cassette + foam inlay for DREMO MINI	225	125	37	296
7620910	8554-99	Plastic cassette + foam insert for DREMO AM	275	150	42	310

SHEET METAL CASE EMPTY FOR DREMOMETER A-F

Use:

✔ Standard packaging for sets of the torque wrench series DREMOMETER A-F

✔ Robust and solid, best for storage and transport

Inclusion:

✔ Solid and robust sheet metal case

✔ With integrated metal-flight and nest-holes for the accessories

✔ Hinges, locks and hand grip made of steel

✔ Paint finish: stove enamelled blue

Scope of delivery:

✔ Sheet metal case only

✔ Delivery in sturdy cardboard packaging



Code	No.	Description	L	W	H	±
7621050	8560-90	Sheet metal case for DREMO A	370	115	50	1200
7621130	8561-90	Sheet metal case for DREMO B	485	115	52	1698
7621210	8562-90	Sheet metal case for DREMO BC/C	630	115	52	1950
7621800	8570-90	Sheet metal case for DREMO CD	745	165	70	3224
7621480	8563-90	Sheet metal case for DREMO D/DS	830	165	73	3713
7622100	8571-90	Sheet metal case for DREMO DR/DX	830	165	73	3656
7621560	8564-90	Sheet metal case for DREMO E / EK	945	270	100	10300
1742876	8572-90	Sheet metal case for DREMO F	1075	190	105	6400



TORCOFIX MODULE SYSTEMS

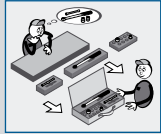

Flexibility with flair

► The module system adapts itself exactly to your wishes and requirements. At last, you can assemble your sets completely individually. Exactly and only using the tools you actually need. For every need, our system provides you with the perfect solution. Whether you choose a standard or an individual solution, your TORCOFIX torque wrenches with or without accessories, are always stored and transported professionally by virtue of the new modular system design.

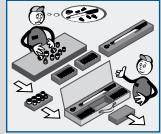

► Your set is flexibly alterable and extendible at all times. Just replace or add modules. The modules themselves are delivered with dummy plugs. Simply remove the plugs from the nest-holes you wish to load with your tools or accessory units. The remaining nest-holes remain closed - that's what we call neat.

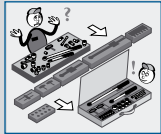

And this is how it is done:

► Just select the appropriate empty modules with the desired or already available tools and pick out a suitable case. Where necessary, fill with fill-in pieces (no. 1400-00) because the case must always be fully loaded.

Or else, even easier:

► You tell us which tools you would like to combine into a set and we will then take care of the rest and you will get your desired set without delay. Finished and ready!



MODULES EMPTY

Use:

► Flexible and individual - usable in combination with the sheet metal cases 1001/1003-90 (modular principle)

► As a part of the standard packaging for sets of the torque wrench series TORCOFIX

Inclusion:

► Solid and robust foam rubber insert

► For torque wrench series TORCOFIX K, SE, UK, Z

► 3 sizes and 16 different designs are available

► Individual component parts - the choice is yours - simply take the dummy plugs out of the nest-holes and insert the accessories for that.

► Flexible modular principle for individual assembling of your set as desired

Scope of delivery:

► Module only

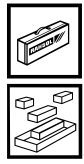

Code	No.	Description	Number of nest-holes	L	W	H	STZ
1582747	1005-00	Module only, for TORCOFIX 4549	for 1 wrench + 5 parts	540	90	70	100
1233378	1010-00	Module only, for TORCOFIX up to 100 Nm	for 1 wrench + 1 ratchet head	540	90	70	100
1233394	1020-00	Module only, for TORCOFIX up to 400 Nm	for 1 wrench + 1 ratchet head	810	90	70	160
1582755	1105-00	Module only, for 1/4" sockets	for 13 parts	270	90	40	100
1582763	1106-00	Module only, for 1/4" screwdriver bit sockets	for 16 parts	270	90	40	100
1233432	1110-00	Module only, for 3/8" sockets and INBUS type end fittings	for 6 parts + 5 parts	270	90	40	30
1233424	1120-00	Module only, for 1/2" sockets, small	for 11 parts	270	90	40	30
1233408	1130-00	Module only, for 1/2" sockets, large	for 9 parts	270	90	40	28
1233467	1140-00	Module only, for 3/8" and 1/2" extensions	for 2 parts	270	90	70	48
1233513	1150-00	Module only, for 3/8" and 1/2" T-grip	for 2 parts	270	90	70	43
1233440	1210-00	Module only, for 1/2" and 16 Z INBUS and TORX type end fittings	for 6 parts	270	90	70	48
1233505	1220-00	Module only, for 16 Z spanner end fittings	for 6 parts	270	90	70	44
1233572	1310-00	Module only, for 9x12 mm spanner end fittings	for 7 parts	270	90	70	50
1233475	1320-00	Module only, for 14x18 mm spanner end fittings, small	for 5 parts	270	90	70	49
1233491	1330-00	Module only, for 14x18 mm spanner end fittings, large	for 4 parts	270	90	70	50
1233521	1400-00	Module only, fill-in piece without nest-holes	for 0 parts	270	90	70	49

SHEET METAL CASE EMPTY FOR TORCOFIX / MODULE

Use:

► Standard packaging for sets of the torque wrench series TORCOFIX

► Robust and solid, best for storage and transport

► Individually to fill up with flexible modules

Inclusion:

► Solid and robust sheet metal case

► For torque wrench series TORCOFIX K/UK, SE, Z

► Hinges, locks and hand grip made of steel

► Paint finish: stove enamelled blue

► Individually to fill up with single modules according your demand (e.g. as a set or with several torque wrenches)

Scope of delivery:

► Sheet metal case only

► Delivery in sturdy cardboard packaging

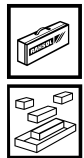

Code	No.	Description	STZ
1149199	1001-90	Sheet metal case empty for TORCOFIX and modules, 540x180x80 mm	2655
1149210	1002-90	Sheet metal case empty for TORCOFIX and modules, 810x180x80 mm	3854
1149202	1003-90	Sheet metal case empty for TORCOFIX and modules, 810x270x80 mm	5111
1255762	1001-91	Cut-out for lid for 1001-90	10
1255770	1002-91	Cut-out for lid for 1002-90	10
1255789	1003-91	Cut-out for lid for 1003-90	10



CERTIFIED PRECISION TRACEABLE SAFETY

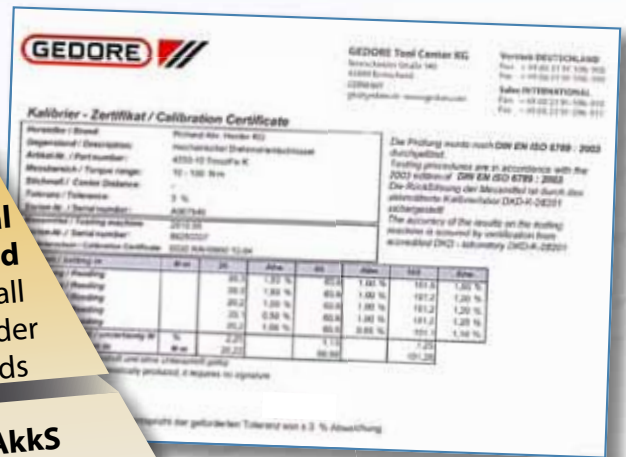

DKD CALIBRATION IN OUR OWN ACCREDITED DKD CALIBRATION LABORATORY

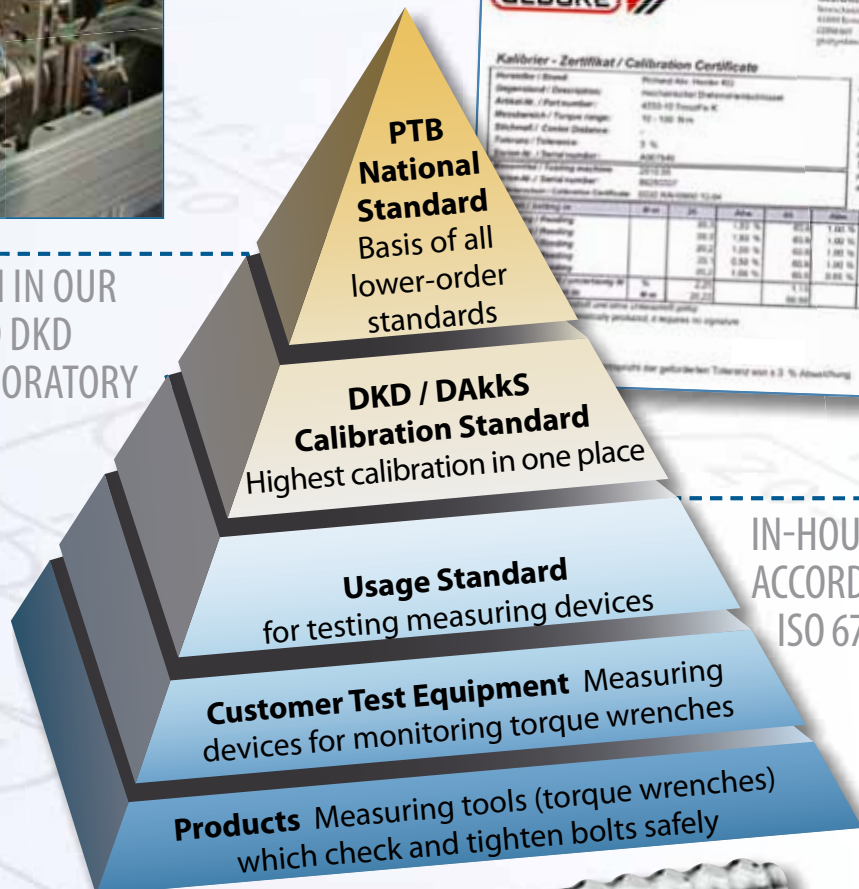

IN-HOUSE CALIBRATION ACCORDING TO DIN EN ISO 6789:2003



DKD CALIBRATION SCOPE OF SERVICES OFFERED BY DKD LABORATORY

Type	Measuring range	Measuring process	Minimum measurement inaccuracy indicated
Type	0,2 N·m – 3000 N·m	DKD 3-7	0,2%
Electr. torque wrench Calibration equipment torque wrench (test devices)	0,2 N·m – 3000 N·m	DKD 3-8	0,2%
Hand-operated torque wrench	0,2 N·m – 1000 N·m	DIN EN ISO 6789:2003	1%

FACTORY CALIBRATIONS

Type	Measuring range	Measuring process	Minimum measurement inaccuracy indicated
Electr. torque wrench	0,2 N·m – 3000 N·m	based on DKD 3-7	0,2%
Calibration equipment torque wrench (test devices)	0,2 N·m – 3000 N·m	based on DKD 3-8	0,2%
Hand-operated torque wrench	0,2 N·m – 1000 N·m	DIN EN ISO 6789:2003	1%
Electr. torque/rotary angle wrench	5 N·m – 300 N·m	BV-STO edition 07/2010 (for measuring angles)	0,2% (Md) 0,5% Measurement accuracy



FACTORY CALIBRATION - SOLID RELIABILITY! ++

WE GIVE YOU THE SECURITY YOU NEED



Our repair service will repair your GEDORE torque wrenches within 5-7 working days.



Our reasonably-priced factory calibration service fulfills the requirements according to DIN EN ISO 6789. Our proprietary accredited DKD calibration laboratory creates certificates in accordance with the applicable standards and requirements as per DKD 3-7 and DKD 3-8 as well as DIN EN ISO 6789:2003.

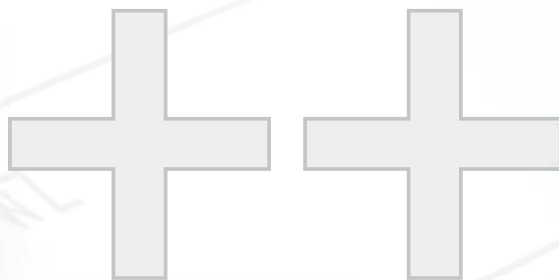

PLEASE NOTE THAT THE TORQUE WRENCH IS AN ITEM OF MEASURING EQUIPMENT.



We recommend:

- Calibration once a year (DIN EN ISO 6789:2003)
- or after 500 load cycles (DIN EN ISO 6789:2003)

Your advantage:

- Torque wrench offering measurement accuracy
- Free* calibration service at Richard Abraham Herder KG in Solingen

*Only applies for items supplied by us (RAHSOL/GEDORE)
Full service package / services only apply for Germany.
Please enquire in our subsidiaries about the possibilities for your respective country.



DKD CALIBRATION



286



FACTORY CALIBRATION



287

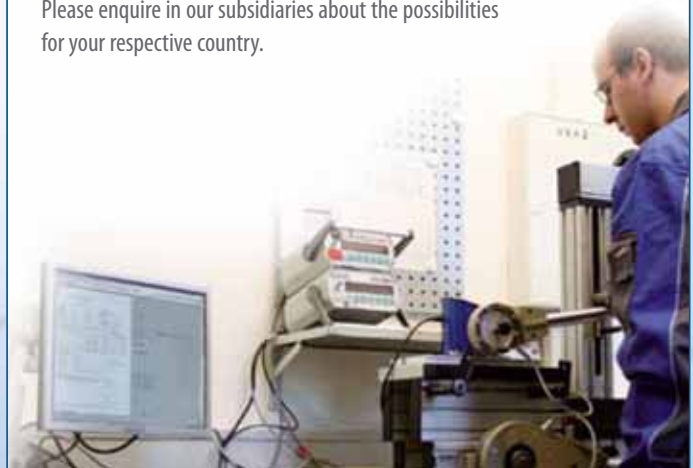



REGULAR CALIBRATION, ADJUSTMENT AND CERTIFICATION

WHY IS THIS SO IMPORTANT?

- Only then can we guarantee the precision and reliability of our torque tools over the long term. We attach a great deal of importance to this as your safety is something which is close to our heart.
- Because we offer you the safety you require for everyday "controlled tightening".



GEDORE -
competent control of the highest level



TORQUE TECHNOLOGY - FOR EXACT AND SAFE SCREWED CONNECTIONS

The use of regularly calibrated torque tools, quality bolts and the "right torque" are absolute prerequisites for safe screwed connections. It should go without saying that this involves the careful and correct selection and application of your torque tools. After all, bolts which are tightened based on a hunch represent a safety risk with potentially serious consequences. If the pre-tension force is too low, the screwed connection can loosen and if it is too high, there is a danger of breaking.

Torque technology is indispensable wherever exactly controlled screw tightening is required. And this involves more screwed connections than you'd think! Every day, our GEDORE tools prove their value in all types of industrial manufacturing, maintenance and repair areas as well as in the area of research and development.

In each of these areas, they offer user maximum safety. Whether standard products or special designs: the outstanding manufacturing quality and extensive service offered by GEDORE ensure continuous reliability, even under extreme conditions.



RECALIBRATION OF TORQUE TOOLS - WHY?

The availability of a once-off calibrated torque wrench is simply not enough in order to guarantee its precision over the long term. Accordingly, just like you have your car serviced regularly, in their capacity as precision measuring equipment, torque tools also require regular servicing.

Therefore, examine your torque tools at least every 5000 load cycles on a traceable calibrated test device. Annual inspection suffices where tools are only used sporadically. Where tools are used more intensively or screwed connections are involved which have safety relevance, we recommend maintaining inspections intervals of 3 to 6 months. Calibration should only be performed by authorised specialist personnel, an accredited DKD calibration laboratory or by the actual manufacturer.

Depending on requirements, such maintenance can involve DKD calibration or factory calibration traceable to national standards.

i TIP

Avail of the competent and swift factory calibration service offered by GEDORE for its torque tools or opt for the DKD calibration service (all makes). You torque tools will be returned within a few working days. And you can continue to use your tools displaying a new level of precision and certified safety without the risk of long downtimes.

Have you got an "intractable" bolt problem? Talk to your torque experts on the phone or in person. Information is available from our service hotline. Ask about our competent calibration partners all over the world - and near you.



Service hotline: +49 (0)1804 37 36 68
(only € 0.20 per call from German land lines; deviations are possible when using mobile phones or service-providers)





GEDORE PRODUCTS - TRACEABLE TO NATIONAL STANDARDS

Traceability is the ultimate cut-off criterion for any calibration. Measuring results must be related to the national standard by means of a continuous chain of comparative measurements. Evidence can be provided in a direct comparison with the national standard or via several calibration steps by means of an indirect comparison with other standards associated with the national standard.

GEDORE torque tools are produced, adjusted, traceably calibrated and certified observing maximum quality demands. They are designed and manufactured in such a way that they comply with or even exceed the requirements of the applicable DIN EN ISO standards, whereby our stringent test and measurement equipment guidelines represent a quality mark of high product quality.

Each new torque wrench, torque screwdriver and test device includes a GEDORE factory test certificate in accordance with the respectively applicable standards. And it goes without saying that our factory test certificates are traceable to national standards. Serial numbers on the product and on the certificate serve towards unambiguous product identification. On request, we can calibrated and certify your torque tools in our own DKD calibration laboratory and in accordance with DKD guidelines. Your tool is then traceable to national standards.



i TIP

Only rely on measurement results achieved using traceable calibrated measuring equipment. Only by association with national standards and therefore the international reference system are test results comparable and quality-based world-wide.

Traceable test equipment management has long been specified for certified companies (DIN EN ISO 9000 ff.).

The calibration hierarchy is depicted in pyramid form and demonstrates all of the levels of traceability currently in place. The fewer the steps from the test object to the national standard, the more reliable the measurement result. DKD calibration - directly traceable - guarantees a very accurate calibration result of the highest level.

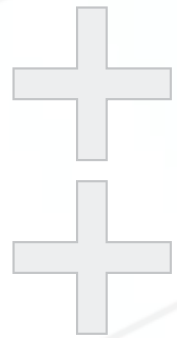

CALIBRATION HIERARCHY: FROM NUTS AND BOLTS TO NATIONAL STANDARDS

TORQUE MEASUREMENT

National standard / Primary standard:
Basis for specifying all subsequent standards of the corresponding size, by official decision. Developed and maintained in Germany by PTB, Braunschweig.

DKD calibration standard / Reference standard:
A standard representing the highest level of accuracy at a certain place (company, laboratory).

Working standard / Factory standard:
A standard which is calibrated in connection with a reference standard and routinely used to calibrate or examine measuring equipment.

Test equipment
Measuring equipment routinely used for calibrating or examining measuring tools (torque wrenches).

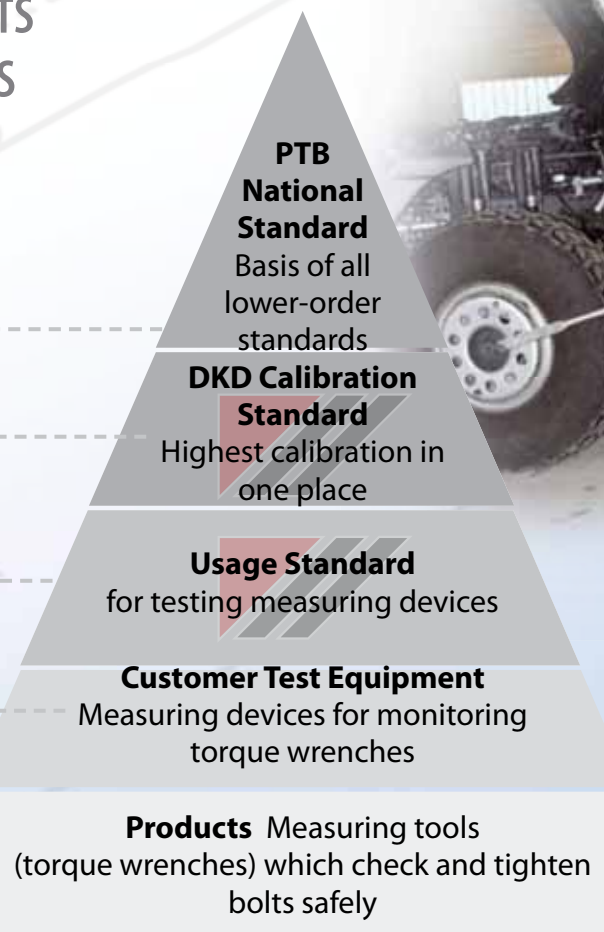



GEDORE COMPANY STANDARDS (RICHARD ABR. HERDER KG)

- ▶ In-house certification according to DIN EN ISO 9001:2000 (initial certification: 1996).
- ▶ Own DKD calibration laboratory for torque measurements (scope of accreditation to DKD: tests in accordance with DKD-R 3-7:2003; DKD-R 3-8:2003; DIN EN ISO 6789:2003) with DKD-K-28201 registration number.
- ▶ National co-operation partner to the German Calibration Service (DKD) since accreditation (DIN EN ISO / IEC 17025) and authorisation by PTB in 2000
- ▶ Mutual international recognition of calibration services among the following countries (EAL): e.g. Germany (DKD), Great Britain (UKAS), Austria (ÖKD), Switzerland (SCS), Australia (NATA), Belgium (BKO), Denmark (DANAK), Finland (FINAS), France (COFRAC), Italy (PRORE)...

- ▶ Official, regular examination of all test and measuring equipment in the DKD laboratory by the Physikalisch-Technische Bundesanstalt in Braunschweig (PTB) and Schatz AG
- ▶ Regular internal testing of all test and measuring equipment
- ▶ Production of all torque tools in accordance with international standards, primarily in accordance with the DIN EN ISO 6789 standards.
- ▶ All electronic torque wrenches or test equipment are developed and manufactured in accordance with the applicable CE Guidelines (EMC).
- ▶ Our torque screwdrivers and some torque wrench ranges are safe as regards electrostatic (ESD).



CONTENTS OF THE DIN EN ISO 6789 STANDARD

The majority of GEDORE torque tools are produced conformant to the requirements of the applicable DIN EN ISO 6789 standard or higher. This standard includes the following key quality and tolerance specifications as well as classifications:

- ▶ Torque tools are divided into type classes with the corresponding demands on accuracy (e.g. class A: actuating torque wrench +/- 4% or class D: dial-indicating screwdriver +/- 6%).
- ▶ Specification of the tolerance working area of a torque tool (20% to 100% of the respective maximum scale or tightening value).
- ▶ Guaranteed reproducibility and precision of the torque for at least 5000 load cycles
- ▶ Allocation of the square drive as regards nominal size and maximum torque value
- ▶ Exact specifications on the test process and test environment (e.g. temperature +18 °C - 28 °C and max. 1% measuring inaccuracy)
- ▶ Details governing measuring inaccuracy of test equipment (max. +/- 1% tolerance of the value shown)
- ▶ Specifications concerning scale and product marking



TESTED QUALITY



DIFFERENCES IN THE CONTENTS OF TEST CERTIFICATES

- The test certificate is a document certifying the accuracy of a torque tool at a certain time. There are differences in terms of form and content between factory test certificates or DKD calibration certificates depending on the product.
- All test certificates and calibration certificates have the following in common: They include exact details on the product name, product item number, working and/or measurement range, serial number, test equipment used, calibration result and the standard according to which tests were carried out. What's more, evidence of traceability as well as the tester's name and the date must also be indicated. This data ensures unambiguous product identification.
- One key difference between factory certificates and DKD calibration certificates concerns indication of the calibration result. The factory certificate does not take consideration of any measurement inaccuracies by test equipment at individual hierarchy steps. The calibration result of the DKD calibration certificate on the other hand includes both the measuring inaccuracy of the test item and test equipment.

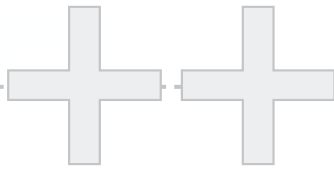

FACTORY TEST CERTIFICATES FOR ADJUSTABLE AND PRE-SET TORQUE WRENCHES

- Factory test certificates for GEDORE torque tools - with scale (Richard Abr. Herder KG factory calibration)
- The test is performed at 20, 60 and 100% of the maximum measurement range of the torque tools to be tested. 5 measurements each are made at these 3 test points. The measurement results (actual values) are compared with the requisite values (target values) and examined for tolerance accuracy. If the measurement results are within the tolerance, a test certificate is automatically generated. If the test values are outside the tolerance, the tool is fine-adjusted and the test repeated.
- Factory test certificates for torque tools - without scale (Richard Abr. Herder KG factory calibration)
- Supplied pre-set to a fixed torque value in the factory: Adjustment to the torque requested by the customer. The test certificate confirms the recurrent accuracy of this fixed value over 5 measurements.
- Supplied without pre-setting - the customer adjusts the tool to the requisite torque value: The test method is the same as for torque wrenches with scale (see above). Here too, the customer receives a
- Test certificate with 5 measurements each performed on the 3 test points (20, 60 and 100% of the maximum measurement range).



GEDORE

GEDORE Tool Center KG
Rensseler Straße 141
42699 Solingen
GEMANY
gh@gedore.com www.gedore.com

VEREIN DEUTSCHLAND
Postfach 1015
42699 Solingen
Sales INTERNATIONAL
Postfach 1015
42699 Solingen

Kalibrier - Zertifikat / Calibration Certificate

Hersteller / Brand: Richard Abr. Herder KG
Gegenstand / Description: mechanischer Drehmomentschlüssel
Artikel-Nr. / Part number: 4100-10 Torqfix 6
Messbereich / Torque range: 10 - 100 Nm
Stichmaß / Center Distance:
Toleranz / Tolerance: ± 3 %
System-Nr. / Serial number: AWT 7648
Messmittel / Testing machine: 2110 09
System-Nr. / Serial number: 94700017
Kaltstellen-Nr. / Calibration Certificate: 033C-PAV 03001 10-04

Die Prüfung wurde nach DIN EN ISO 6789 : 2003 durchgeführt.
Testing procedures are in accordance with the 2003 edition of DIN EN ISO 6789 : 2003
Die Rückführung der Messmittel an durch das akkreditierte Kalibrierlabor DKD-N-28201 ist hergestellt.
The accuracy of the results on the testing machine is assured by certification from accredited DKD - laboratory DKD-N-28201

Substanz / Setting in	Min	20		60		100	
		Abw.	1,00 %	Abw.	1,00 %	Abw.	1,00 %
1. Prüfung / Reading	20,3	1,00 %	60,8	1,00 %	101,9	1,00 %	
2. Prüfung / Reading	20,3	1,00 %	60,8	1,00 %	101,2	1,00 %	
3. Prüfung / Reading	20,2	1,00 %	60,8	1,00 %	101,2	1,00 %	
4. Prüfung / Reading	20,4	1,00 %	60,8	1,00 %	101,2	1,00 %	
5. Prüfung / Reading	20,3	1,00 %	60,8	0,83 %	101,1	1,10 %	
Mittelwert / Average in	%	0,25	1,13		1,25		
Abw. / Deviation in	%	20,20	60,80		101,20		

Zertifikat ist per EDS zu erhalten und ohne Unterschrift gültig.
As this certificate is automatically produced, it requires no signature.

Datum: 08.10.2016
Der Drehmomentschlüssel entspricht der geforderten Toleranz von ± 3 % Abweichung.

NOTE

At Richard Abr. Herder KG, all GEDORE torque tools are subjected to a 100% quality check. We guarantee the tolerance accuracy of our tools in accordance with the applicable DIN standards.

NOTE

On request, all of our torque wrenches and test equipment can also be calibrated and certified in line with all DKD guidelines. Ask us about prices for DKD certification.



WE GIVE YOU THE
SECURITY YOU NEED + +
DKD CALIBRATION - 100% DOCUMENTED SAFETY

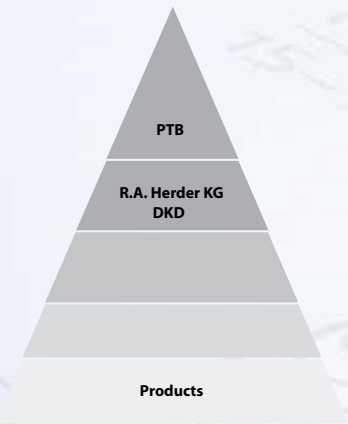

- ▶ Direct traceability to the national standard
- ▶ DKD calibrations to DKD Guidelines: DKD-R 3-7:2003; DKD-R 3-8:2003 and DIN EN ISO 6789:2003
- ▶ Minimum measurement inaccuracies
- ▶ DKD calibration of our own products and those of other manufacturers
- ▶ Air-conditioned laboratory controls under the most stringent conditions
- ▶ DKD calibration certificate and DKD calibration stamp

DKD CALIBRATION CERTIFICATE

The DKD calibration certificate documents the calibration result - the DKD calibration mark on the test item identifies the DKD laboratory performing calibration. Please note our registration number: DKD-K-28201. During the test process, the Richard Abr. Herder KG calibration laboratory is obliged to comply with the contractual criteria of the DAkkS (formerly DKD).

- ▶ Apart from the standard test certificate contents, the DKD calibration certificate also takes consideration of the measurement inaccuracies of the test equipment used. The documented calibration result includes the measuring inaccuracies of both the test item and the test equipment.
- ▶ DKD calibration therefore represents maximum safety for controlled tightening. We advise using it for larger test items or test equipment subject to continuous use.

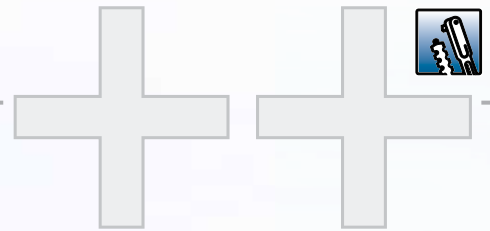
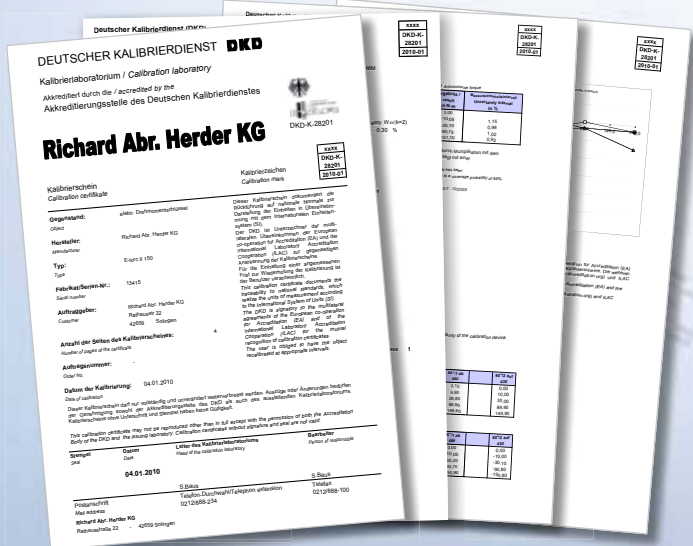

Example:

- ▶ A torque wrench is calibrated in accordance with DIN EN ISO 6789:2003. Calibration is performed on test equipment approved by DKD (DAkkS).
- ▶ Depending on the design and type, the torque wrench is calibrated at $\pm 4\%$ or $\pm 6\%$.
- ▶ In addition to measurement deviations, measurement inaccuracy is also documented in the DKD calibration certificate.
- ▶ The torque wrench can be used in accordance with the applicable DIN EN ISO standards.

DKD calibration equipment

- ▶ We calibrate your test equipment or torque wrenches on DKD-calibrated reference wrenches or test equipment. DKD calibrations of test equipment are performed regularly by PTB and/or Schatz. This fact ensures that the maximum possible accuracies and minimum possible measurement inaccuracies are provided. Before each calibration process, a preliminary test is performed in our DKD laboratory on each item of calibration equipment and on each reference wrench.

International recognition

- ▶ The DKD calibration certificate and therefore the measurement results listed are recognised in many other countries as official evidence of traceability. This is based on multilateral treaties.

i NOTE

Calibration always represents a snapshot! Within the framework of calibration, deviations in measurements and measurement inaccuracies are recorded on a certain date and documented accordingly in the calibration certificate. Using these calibration results, a statement can be made as regards tolerance accuracy since the previous calibration. No statement can however be made as regards future performance.

If you have any queries, simply call our service hotline:
+49 (0)1804 37 36 68.
(only € 0.20 per call from German land lines; prices may vary when using mobile phones or service-providers)



WE GIVE YOU THE
SECURITY YOU NEED ++
FACTORY CALIBRATION -
SOLID RELIABILITY!

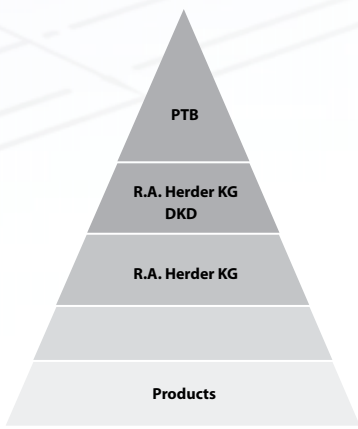





- Direct traceability to the national standard
- Factory calibration according to the standard DIN EN ISO 6789:2003
- Factory calibration if necessary with adjustments and repairs - for GEDORE products only
- Factory test certificate and calibration stamp

FACTORY TEST CERTIFICATE ACCORDING TO DIN EN ISO 6789:2003

- It contains information about the test item, measurement results, the test equipment used and the classification of the test item according to DIN EN ISO 6789:2003 (e.g. Type II Class A).
- The calibration is carried out on test equipment, which comply with the DIN EN ISO 6789:2003.
- The calibration result of the factory certificate does not take consideration of any measurement inaccuracies by test equipment at individual hierarchy steps.
- The documented measuring inaccuracies refers only to the test item.

FACTORY CALIBRATION

TEST SUBJECT	TEST DEVICE	TEST RESULT
 <p>Mech. torque wrench 0,2-1.000 N·m</p>		
 <p>Electr. torque wrench Torque testers 0,2-3.000 N·m</p>		
 <p>0,2-3.000 N·m</p>		

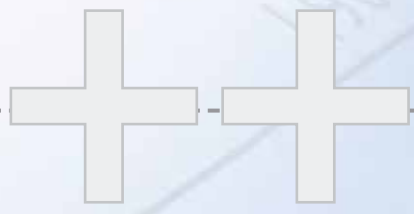

i NOTE

The generation of a factory test certificate in accordance with GEDORE criteria as well as adjustment and repair is exclusively possible for torque wrenches and test equipment manufactured by us.

Factory and DKD calibrations involve right calibration. Left calibration also available on request.

Depending on the requirements or customer requests, we calibrate in accordance with DKD guidelines or GEDORE criteria



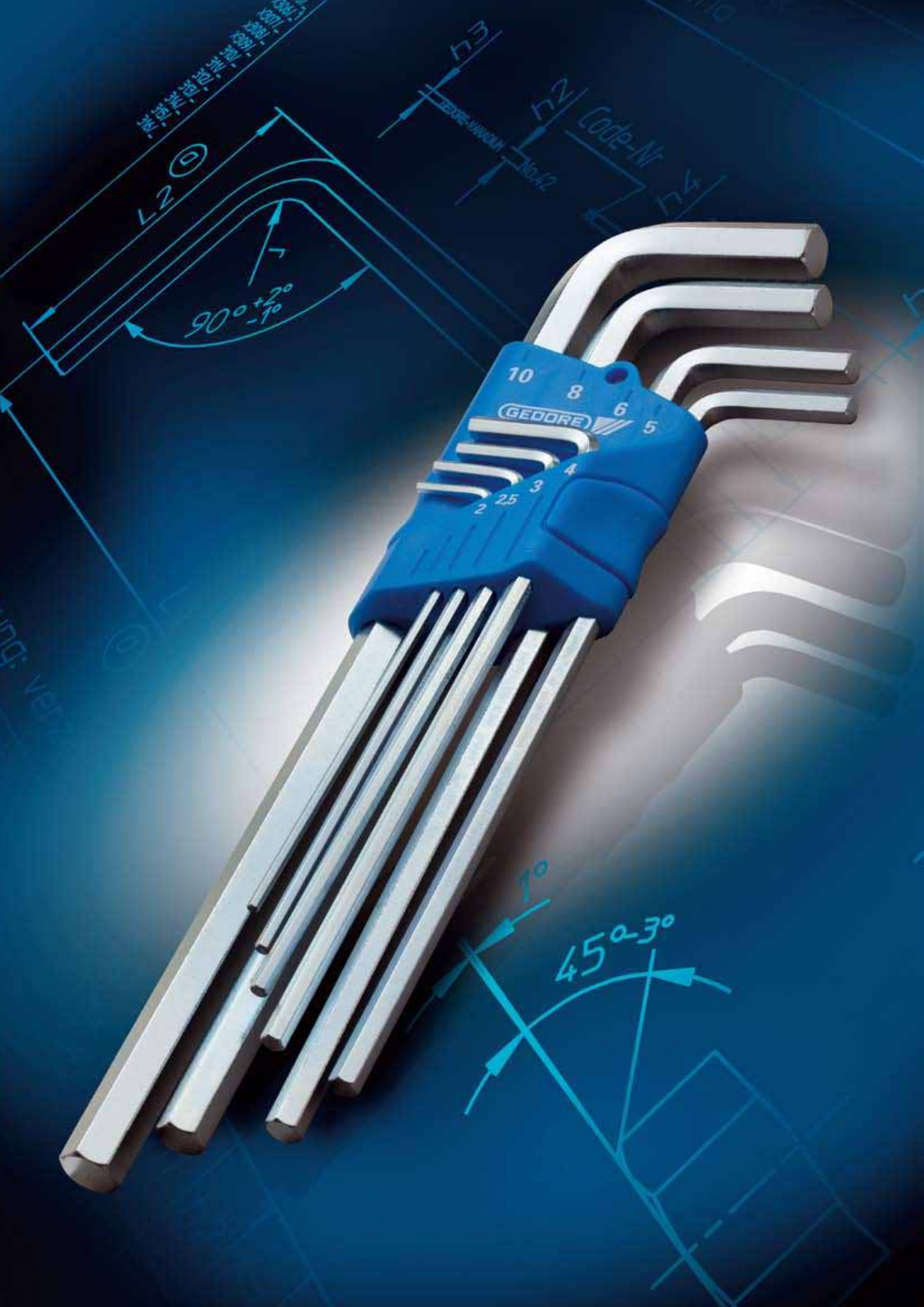



FOR EXTRA POWER



++ THE PERFECT DRIVE ++



SERVICE / FEATURES

290

3C-SCREWDRIVER



291 - 294

3C-SCREWDRIVER WITH STRIKING CAP



295



SCREWDRIVER WITH WOODEN HANDLE



296

ELECTRONIC SCREWDRIVER



296 - 297

HEXAGON ALLEN KEYS



298 - 303

TORQUE SCREWDRIVER



304 - 305



For further models see product group Torque Tools page 258 - 259



VOLTAGE TESTER



305



VARIOUS



305



DREMO PLUS 3 C +

DESIGNED FOR EXTRA STRENGTH AND DURABILITY!

FEATURES

Advantages

The soft component in the rear part of the handle. It permits the full force of the hand to be employed in turning the screwdriver and prevents early tiredness when the tool is used continually.

The robust core is in the inside of the handle. It absorbs the force from the outer components and transfers it safely to the shaft.

The hard component in the front part of the handle has been designed to make fast turning with low resistance much easier.

The blade in chrome vanadium steel is fully hardened over the whole length and thus fulfills all the requirements for safe working.

In the case of stubborn screws, the forged-on hexagon bolster permits an increase in the torque with the use of an adjustable spanner. (Only screwdrivers 2154SK, 2160SK and 2154)

Seized screws are loosened by gently knocking on the striking cap. The striking cap transfers the impact energy to the blade by means of a special damping system so that it is easy on the hands and prevents bounce.



i Good torque transfer, irrespective of hand size

- Head marking for specifically and rapidly accessing the right screwdriver
- Colour code of the drive type

i Good torque transfer, irrespective of hand size

M

XL

88

506

494



3C-SCREWDRIVER

2150

3C-SCREWDRIVER for slotted head screws

- Acc. to DIN ISO 2380-2, blade tip acc. to DIN ISO 2380-1 Form A
- Blade in vanadium plus steel, chrome-plated
- 3-component handle with hanging hole
- * not standardised



Code	No.	*	mm _± ≪	mm _± ≧	∅	mm	mm	mm	mm	mm	mm
6679270	2150 3	*	0.5	3.0	3	80	160	30	10		
6679350	2150 4		0.8	4.0	4	100	190	52	10		
6679430	2150 5,5		1.0	5.5	5	125	225	79	10		
6679510	2150 6,5		1.2	6.5	6	150	260	110	10		
6679780	2150 8		1.2	8.0	7	175	295	150	10		
6679860	2150 10		1.6	10.0	8	200	320	183	10		
6679940	2150 12		2.0	12.0	9	250	370	237	10		
1828673	2150 14	*	2.5	14.0	11	250	370	309	1		

2150

3C-SCREWDRIVER for slotted head screws, special lengths

- With parallel blade, apart from length 300/400
- Blade tip acc. to DIN ISO 2380-1 Form B
- Blade in vanadium plus steel
- 3-component handle with hanging hole
- * not standardised



Code	No.	*	mm _± ≪	mm _± ≧	∅	mm	mm	mm	mm	mm
6680010	2150 3-100		0.5	3.0	3.0	100	180	32	10	
6680280	2150 3-150	*	0.5	3.0	3.0	150	230	35	10	
6680360	2150 4-150	*	0.8	4.0	4.0	150	240	60	10	
6680440	2150 5,5-100		1.0	5.5	5.5	100	200	77	10	
6680520	2150 5,5-150		1.0	5.5	5.5	150	250	90	10	
6680600	2150 5,5-250	*	1.0	5.5	5.5	250	350	111	10	
6680790	2150 6,5-100		1.2	6.5	6.5	100	210	108	10	
6680870	2150 6,5-200	*	1.2	6.5	6.5	200	310	134	10	
1646478	2150 6,5-300	*	1.2	6.5	6.0	300	410	14	1	
1646486	2150 6,5-400	*	1.2	6.5	6.0	400	510	16	1	
6680950	2150 8-125		1.2	8.0	8.0	125	245	152	10	
6681090	2150 8-225	*	1.2	8.0	8.0	225	345	194	10	
1646494	2150 8-300	*	1.2	8.0	8.0	300	420	21	1	
1646508	2150 8-400	*	1.2	8.0	8.0	400	520	25	1	
6681170	2150 10-150		1.6	10.0	10.0	150	270	210	10	
6681840	2150 10-250	*	1.6	10.0	10.0	250	370	273	10	

2153

SCREWDRIVER for slotted head screws, stubby

- Acc. to DIN ISO 2380-2, blade tip acc. to DIN ISO 2380-1 Form B
- Blade in vanadium plus steel, chrome-plated
- 1-component handle, blue, with hanging hole



Code	No.	mm _± ≪	mm _± ≧	∅	mm	mm	mm	mm
1531174	2153 4	0.8	4.0	4.0	25	75	31	10
1482432	2153 5,5	1.0	5.5	5.5	25	75	36	10
1531182	2153 6,5	1.2	6.5	6.5	25	75	39	10
1531190	2153 8	1.2	8.0	8.0	25	75	44	10

2154

3C-SCREWDRIVER for slotted head screws

- Blade with hexagon bolster
- Acc. to DIN ISO 2380-2, blade tip acc. to DIN ISO 2380-1 Form A
- Blade in vanadium plus steel, chrome-plated
- 3-component handle with hanging hole
- * not standardised

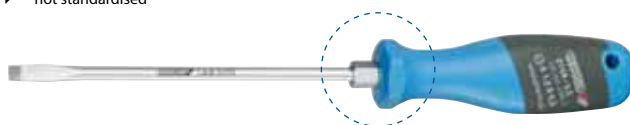

Code	No.	*	mm _± ≪	mm _± ≧	∅	mm	mm	mm	mm	mm
1828681	2154 3,5	*	0.6	3.5	4	75	180	8	66	10
6682490	2154 4,5	*	0.8	4.5	5	100	200	8	73	10
6682570	2154 5,5		1.0	5.5	5	100	200	8	75	10
6682650	2154 6,5		1.2	6.5	6	125	235	10	109	10
6682730	2154 8		1.2	8.0	7	150	270	13	152	10
6682810	2154 10		1.6	10.0	8	175	295	13	180	10
6683030	2154 12		2.0	12.0	9	200	320	16	227	10
1531158	2154 14		2.5	14.0	11	250	370	16	332	10

2170

3C-SCREWDRIVER for slotted head screws, insulated blade

- Acc. to DIN ISO 2380-2, blade tip acc. to DIN ISO 2380-1 Form B
- Blade in vanadium plus steel, chrome-plated
- 3-component handle with hanging hole



Code	No.	mm _± ≪	mm _± ≧	∅	mm	mm	mm	mm
6678700	2170 2,5	0.4	2.5	2,5	75	155	28	10
6678890	2170 3	0.5	3.0	3,0	75	155	30	10
6678970	2170 4	0.8	4.0	4,0	100	190	53	10
6679000	2170 5,5	1.0	5.5	5,5	125	225	88	10
6679190	2170 6,5	1.2	6.5	6,5	150	260	123	10

2160 PH

3C-SCREWDRIVER for cross-slotted head screws PH

- Acc. to DIN ISO 8764, tip acc. to DIN ISO 8764-1 PH
- Blade in vanadium plus steel, chrome-plated
- 3-component handle with hanging hole
- Size 3 and 4 blade with hexagon bolster
- * not standardised



Code	No.	*	PH	mm	∅	mm	mm	mm	mm	
6683110	2160 PH 0		0	M1,6 - M2	3,0	60	140	293	10	
6683380	2160 PH 1		1	M2 - M3	4,5	80	180	66	10	
6683700	2160 PH 1-200		1	M2 - M3	4,5	200	300	152	10	
6683460	2160 PH 2		2	M3,5 - M5	6,0	100	210	101	10	
6683890	2160 PH 2-200		2	M3,5 - M5	6,0	200	310	146	10	
1646516	2160 PH 2-300	*	2	M3,5 - M5	6,0	300	410	14	1	
1646524	2160 PH 2-400	*	2	M3,5 - M5	6,0	400	510	158	1	
6683540	2160 PH 3		3	M5,5 - M7	8,0	150	270	13	172	10
6683620	2160 PH 4		4	M8 - M10	10,0	200	320	16	254	10

2161 PH

SCREWDRIVER for cross-slotted head screws PH, stubby

- Acc. to DIN ISO 8764, tip acc. to DIN ISO 8764-1 PH
- Blade in vanadium plus steel, chrome-plated
- 1-component handle, blue, with hanging hole



Code	No.	PH	mm	∅	mm	mm	mm
1482440	2161 PH 1	1	M2 - M3	4,5	25	75	33
1531204	2161 PH 2	2	M3,5 - M5	6,0	25	75	36



2160 PZ

3C-SCREWDRIVER for cross-slotted head screws PZ

- Acc. to DIN ISO 8764, tip acc. to DIN ISO 8764-1 PZ
- Blade in vanadium plus steel, chrome-plated
- 3-component handle with hanging hole
- Size 3 and 4 blade with hexagon bolster



Code	No.	⊕ PZ	□ mm	∅	mm	mm	mm	mm	mm
6683970	2160 PZ 0	0	M1,6 - M2	3,0	60	140	29	10	
6684000	2160 PZ 1	1	M2 - M3	4,5	80	180	65	10	
6684190	2160 PZ 2	2	M3,5 - M5	6,0	100	210	101	10	
6684270	2160 PZ 3	3	M5,5 - M7	8,0	150	270	13	169	10
6684350	2160 PZ 4	4	M8 - M10	10,0	200	320	16	253	10

2161 PZ

SCREWDRIVER for cross-slotted head screws PZ, stubby

- Acc. to DIN ISO 8764, tip acc. to DIN ISO 8764-1 PZ
- Blade in vanadium plus steel, chrome-plated
- 1-component handle, blue, with hanging hole



Code	No.	⊕ PZ	□ mm	∅	mm	mm	mm	mm
1550608	2161 PZ 1	1	M2 - M3	4,5	25	75	32	10
1550616	2161 PZ 2	2	M3,5 - M5	6,0	25	75	37	10

2163 BTX

3C-SCREWDRIVER for recessed TORX® head screws

- Blade in vanadium plus steel, chrome-plated
- 3-component handle with hanging hole
- TORX® = reg. trademark of Acument Intellectual Properties, LLC. USA



Code	No.	⊕	□ mm	∅ mm	∅	mm	mm	mm	mm
1828703	2163 BTX T3	T3	M1,2 - M1,4	1.13	3,0	60	140	28	10
1828711	2163 BTX T4	T4	M1,4	1.29	3,0	60	140	27	10
1616471	2163 BTX T5	T5	M1,8	1.42	3,0	60	140	28	10
6685400	2163 BTX T6	T6	M2	1.69	3,0	60	140	29	10
6685590	2163 BTX T7	T7	M2,5	1.99	3,0	60	140	29	10
6685670	2163 BTX T8	T8	M2,5	2.31	3,0	60	140	29	10
6685750	2163 BTX T9	T9	M3	2.50	3,0	60	140	29	10
6685830	2163 BTX T10	T10	M3 - M3,5	2.74	3,0	80	160	30	10
6685910	2163 BTX T15	T15	M3,5 - M4	3.27	3,5	80	170	45	10
6686050	2163 BTX T20	T20	M4 - M5	3.86	4,0	100	190	51	10
6686130	2163 BTX T25	T25	M4,5 - M5	4.43	4,5	100	200	68	10
6686210	2163 BTX T27	T27	M4,5 - M6	4.99	5,5	115	215	84	10
6686480	2163 BTX T30	T30	M6 - M7	5.52	6,0	115	225	105	10
6686560	2163 BTX T40	T40	M7 - M8	6.65	7,0	130	240	126	10
6686640	2163 BTX T45	T45	M8 - M10	7.82	8,0	130	250	156	10
6686720	2163 BTX T50	T50	M10	8.83	9,0	150	270	186	10

2163 TXB

3C-SCREWDRIVER for recessed TORX® head screws with pilot

- Blade in vanadium plus steel, chrome-plated
- 3-component handle with hanging hole
- TORX® = reg. trademark of Acument Intellectual Properties, LLC. USA

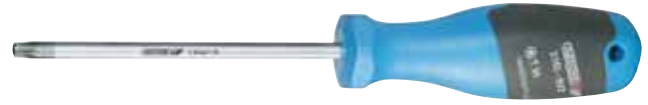

Code	No.	⊕	□ mm	∅ mm	∅	mm	mm	mm	mm
1828738	2163 TXB T6	T6	M2	1.69	3,0	60	140	29	10
6677570	2163 TXB T7	T7	M2,5	1.99	3,0	60	140	25	10
6677650	2163 TXB T8	T8	M2,5	2.31	3,0	60	140	29	10
6677730	2163 TXB T9	T9	M3	2.50	3,0	60	140	29	10
6677810	2163 TXB T10	T10	M3 - M3,5	2.74	3,0	80	160	30	10
6678030	2163 TXB T15	T15	M3,5 - M4	3.27	3,5	80	170	45	10
6678110	2163 TXB T20	T20	M4 - M5	3.86	4,0	100	190	51	10
6678380	2163 TXB T25	T25	M4,5 - M5	4.43	4,5	100	200	68	10
6678460	2163 TXB T27	T27	M4,5 - M6	4.99	5,5	115	215	84	10
6678540	2163 TXB T30	T30	M6 - M7	5.52	6,0	115	225	105	10
6678620	2163 TXB T40	T40	M7 - M8	6.65	7,0	130	240	125	10

2163 BK

3C-SCREWDRIVER for in-hex screws, with ball end

- Blade in vanadium plus steel, chrome-plated
- 3-component handle with hanging hole

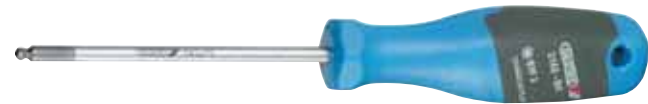

Code	No.	∅ mm	∅	mm	mm	mm	mm
1828746	2163 BK 2	2	3	75	155	31	10
6684430	2163 BK 3	3	4	75	155	36	10
6684510	2163 BK 4	4	5	100	190	59	10
6684780	2163 BK 5	5	6	100	200	86	10
6684860	2163 BK 6	6	7	125	235	121	10
6684940	2163 BK 8	8	10	150	270	210	10
6685080	2163 BK 10	10	12	150	270	265	10
6685160	2163 BK 12	12	14	160	280	349	10

3C-SCREWDRIVER SETS

2150-2160 PH

3C-SCREWDRIVER SET 6 pieces / 10 pieces

- Practical set composition in environmentally-friendly cardboard box
- For slotted and cross-slotted head screws PH
- Blades in vanadium plus steel, chrome-plated
- 3-component handle with hanging hole



Code	No.	Contents	mm	mm
1482319	2150-2160 PH-06	⊖ 2150 4 5,5 6,5 8 ⊕ 2160 PH 1 2	660	1
1482343	2150-2160 PH-010	⊖ 2150 3 4 5,5 6,5 8 ⊖ 2153 5,5 ⊕ 2160 PH 1 2 ⊕ 2161 PH 1 ⊖ 4615 3,5	825	1

Deviant packing units see article description.





2154-2160 PH-07

3C-SCREWDRIVER SET 7 pieces

- Practical set composition in environmentally-friendly cardboard box
- For slotted and cross-slotted head screws PH
- Blade with hexagon bolster
- Blade in vanadium plus steel, chrome-plated
- 3-component handle with hanging hole



Code	No.	Contents	📦	📦
1731149	2154-2160 PH-07	⊖ 2154 4,5 5,5 6,5 8 ⊕ 2160 PH 1 2 ⊕ 4615 3	715	1

2150-2160 PZ-06

3C-SCREWDRIVER SET 6 pieces

- Practical set composition in environmentally-friendly cardboard box
- For slotted and cross-slotted head screws PZ
- Blades in vanadium plus steel, chrome-plated
- 3-component handle with hanging hole



Code	No.	Contents	📦	📦
1482300	2150-2160 PZ-06	⊖ 2150 4 5,5 6,5 8 ⊕ 2160 PZ 1 2	670	1

2160 PHZ-06

3C-SCREWDRIVER SET 6 pieces

- Practical set composition in environmentally-friendly cardboard box
- For cross-slotted head screws PH and PZ
- Blade in vanadium plus steel, chrome-plated
- 3-component handle with hanging hole

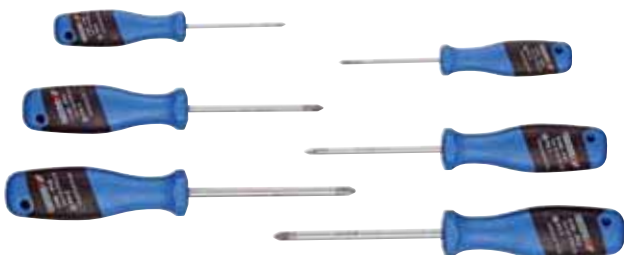

Code	No.	Contents	📦	📦
2003589	2160 PHZ-06	⊕ 2160 PH 0 1 2 ⊕ 2160 PZ 0 1 2	344	1

2163 BTX

3C-SCREWDRIVER SET 5 pieces / 10 pieces

- Practical set composition in environmentally-friendly cardboard box
- For recessed TORX® head screws
- Blade in vanadium plus steel, chrome-plated
- 3-component handle with hanging hole
- TORX® = reg. trademark of Acument Intellectual Properties, LLC. USA

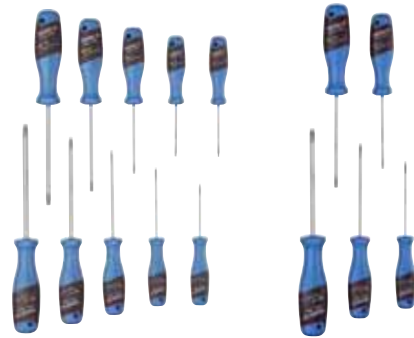

Code	No.	Contents	📦	📦
1482327	2163 BTX-05	⊕ 2163 BTX T10 T15 T20 T25 T30	435	1
1482335	2163 BTX-010	⊕ 2163 BTX T7 T8 T9 T10 T15 T20 T25 T27 T30 T40	740	1



2163 TXB-05

3C-SCREWDRIVER SET 5 pieces

- Practical set composition in environmentally-friendly cardboard box
- For recessed TORX® head screws with pilot
- Blade in vanadium plus steel, chrome-plated
- 3-component handle with hanging hole
- TORX® = reg. trademark of Acument Intellectual Properties, LLC. USA



Code	No.	Contents	📦	📦
1616617	2163 TXB-05	⊕ 2163 TXB T10 T15 T20 T25 T30	440	1

VS 2155 S

SCREWDRIVER SALES STAND 155 pieces

- Blade in vanadium plus steel, chrome-plated
- 3-component handle with hanging hole
- Display made from acrylic glass, dimensions: W 580 x H 380 x D 80 mm



Code	No.	Contents	📦	📦
6424600	VS 2155 S	5x ⊖ 2150 3 4 5,5 6,5 8 10 5x ⊖ 2154 5,5 6,5 8 10 12 5x ⊖ 2153 5,5 6,5 8 5x ⊖ 2170 2,5 3 4 5,5 6,5 5x ⊕ 2160 PH 0 1 2 3 4 5x ⊕ 2161 PH 1 2 5x ⊕ 2160 PZ 0 1 2 3 4	21.0	1





VS 2150-2154

SCREWDRIVER SALES STAND 48 pieces

- For slotted head screws
- Dimensions: W 440 x H 290 x D 140 mm





Code	No.	Contents		
1948458	VS 2150-2154	4x \ominus 2150 3 4 5,5 6,5 8 10 4x \ominus 2153 5,5 6,5 4x \ominus 2154 6,5 8 10 12	8.3	1

VS 2150 XL

SCREWDRIVER SALES STAND 36 pieces

- For slotted head screws, special lengths
- Dimensions: W 325 x H 185 x D 100 mm





Code	No.	Contents		
1948482	VS 2150 XL	4x \ominus 2150 3-100 3-150 4-150 5,5-100 5,5-150 6,5-200 8-125 8-225 10-150	6.8	1

VS 2160-2161

SCREWDRIVER SALES STAND 48 pieces

- For cross-slotted head screws PH and PZ
- Dimensions: W 440 x H 180 x D 100 mm





Code	No.	Contents		
1948431	VS 2160-2161	4x \oplus 2160 PH 0 1 2 3 4 4x \oplus 2161 PH 1 2 4x \oplus 2160 PZ 0 1 2 3 4	8.2	1

VS 2163

SCREWDRIVER SALES STAND 40 pieces

- For recessed TORX® head screws and recessed TORX® head screws with pilot
- Dimensions: W 325 x H 190 x D 100 mm
- TORX® = reg. trademark of Acument Intellectual Properties, LLC. USA



Code	No.	Contents		
1948466	VS 2163 BTX	4x \otimes 2163 BTX T6 T7 T8 T9 T10 T15 T20 T25 T27 T30	4.8	1
1948474	VS 2163 TXB	4x \otimes 2163 TXB T6 T7 T8 T9 T10 T15 T20 T25 T27 T30	4.7	1

www.gedore.com



3C-SCREWDRIVER WITH STRIKING CAP

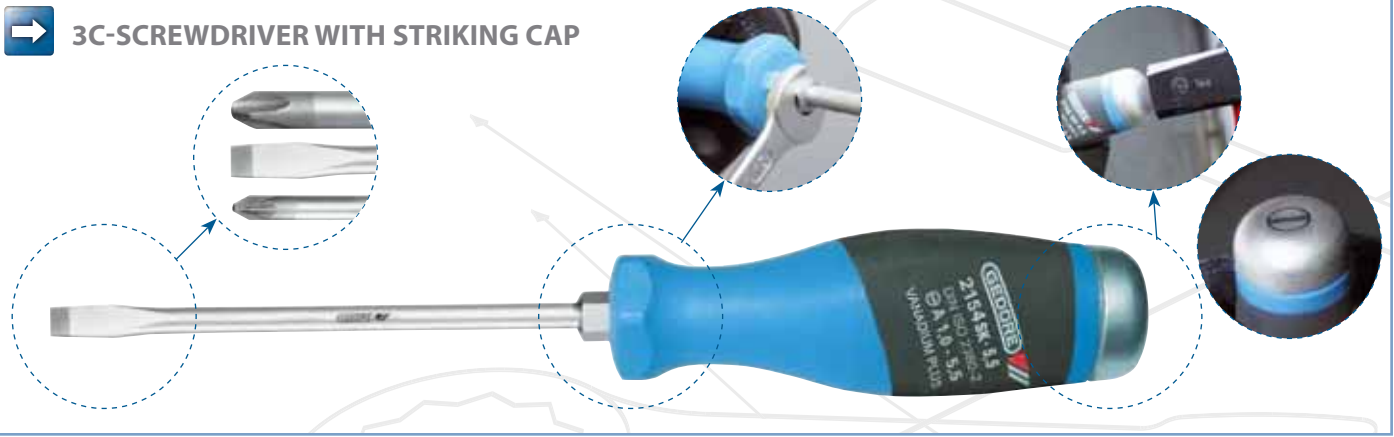

3C-SCREWDRIVER WITH STRIKING CAP

2154SK

3C-SCREWDRIVER WITH STRIKING CAP for slotted head screws

- Acc. to DIN ISO 2380-2, blade tip acc. to DIN ISO 2380-1 Form A
- Blade with hexagon bolster
- Blade in vanadium plus steel, chrome-plated
- 3-component handle



Code	No.	mm	mm	Ø	mm	mm	mm	mm	mm
1845209	2154SK 3,5	0.6	3.5	4	75	180	8	86	1
1845217	2154SK 4,5	0.8	4.5	5	90	195	8	90	1
1845225	2154SK 5,5	1.0	5.5	5	100	205	8	92	1
1845233	2154SK 6,5	1.2	6.5	6	125	245	10	154	1
1845241	2154SK 8	1.2	8.0	7	150	270	13	178	1
1845268	2154SK 10	1.6	10.0	8	175	295	13	214	1
1845276	2154SK 12	2.0	12.0	9	200	320	16	260	1
1845284	2154SK 14	2.5	14.0	11	200	320	16	324	1

2160SK PH

3C-SCREWDRIVER WITH STRIKING CAP for cross-slotted head screws PH

- Acc. to DIN ISO 8764, tip acc. to DIN ISO 8764-1 PH
- Blade with hexagon bolster
- Blade in vanadium plus steel, chrome-plated
- 3-component handle

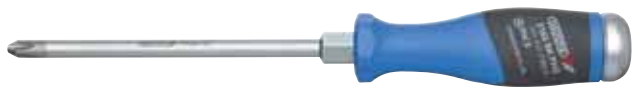

Code	No.	PH	mm	Ø	mm	mm	mm	mm	mm
1845292	2160SK PH 1	1	M2 - M3	4	80	185	8	86	1
1845306	2160SK PH 2	2	M3,5 - M5	6	120	220	10	148	1
1845314	2160SK PH 3	3	M5,5 - M7	8	150	270	13	204	1
1845322	2160SK PH 4	4	M8 - M10	10	200	320	16	292	1

2160SK PZ

3C-SCREWDRIVER WITH STRIKING CAP for cross-slotted head screws PZ

- Acc. to DIN ISO 8764, tip acc. to DIN ISO 8764-1 PZ
- Blade with hexagon bolster
- Blade in vanadium plus steel, chrome-plated
- 3-component handle



Code	No.	PZ	mm	Ø	mm	mm	mm	mm	mm
1845330	2160SK PZ 1	1	M2 - M3	4	80	185	8	86	1
1845349	2160SK PZ 2	2	M3,5 - M5	6	120	220	10	148	1
1845357	2160SK PZ 3	3	M5,5 - M7	8	150	270	13	206	1
1845365	2160SK PZ 4	4	M8 - M10	10	200	320	16	292	1

SK 2154 PH-06

3C-SCREWDRIVER SET WITH STRIKING CAP 6 pieces

- Practical set composition in environmentally-friendly cardboard box
- For firmly seated slotted and cross-slotted head screws PH
- Blade with hexagon bolster
- Blade in vanadium plus steel, chrome-plated
- 3-component handle



Code	No.	Contents	mm	mm
1878743	SK 2154 PH-06	⊖ 2154SK 4,5 5,5 6,5 8 ⊕ 2160SK PH 1 2	880	1





SCREWDRIVER WITH WOODEN HANDLE

147

SCREWDRIVER for slotted head screws

- ✔ Similar to DIN ISO 2380-2 Row B+C, blade tip acc. to DIN ISO 2380-1 Form A
- ✔ Blade tanged right through the handle, chrome-plated
- ✔ GEDORE vanadium steel 50CrV4
- ✔ Hardwood handle, clear varnished with leather cap
- ✔ Hexagon bolster for extra power

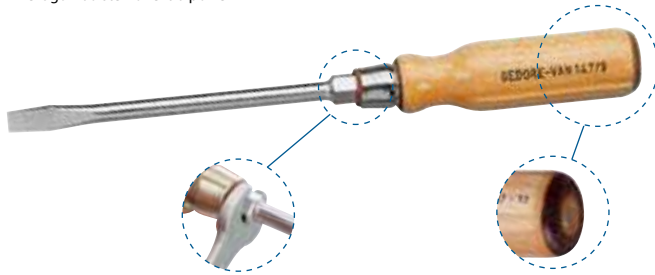

Code	No.	mm _±	mm _±	mm	mm	mm	mm	mm
6413830	147 3,5	3.5	0.6	75	170	6	55	5
6413910	147 4,5	4.5	0.8	90	185	6	59	5
6414050	147 5,5	5.5	1.0	100	200	8	73	10
6414130	147 7	7.0	1.2	125	235	10	112	10
6414210	147 9	9.0	1.4	150	270	12	166	10
6414480	147 10	10.0	1.6	175	300	12	192	5
6414560	147 12	12.0	2.0	200	330	13	250	5



148

SCREWDRIVER for slotted head screws

- ✔ Similar to DIN ISO 2380-2 Row B+C, blade tip acc. to DIN ISO 2380-1 Form A
- ✔ Hexagon blade with forged bolster
- ✔ Blade tanged right through the handle, chrome-plated
- ✔ GEDORE vanadium steel 50CrV4
- ✔ Hardwood handle, clear varnished with leather cap

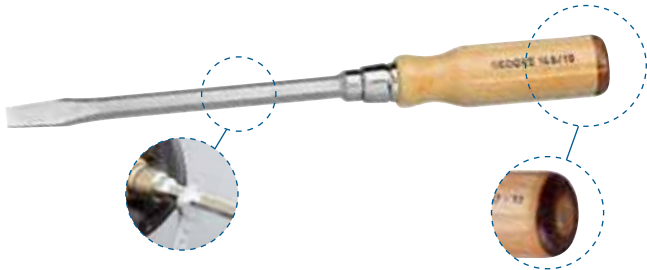

Code	No.	mm _±	mm _±	mm	mm	mm	mm	mm
6415020	148 5,5	5.5	0.8	100	200	6	83	5
6415100	148 7	7.0	1.0	125	230	7	123	5
6415290	148 8	8.0	1.2	150	270	8	174	5
6415370	148 10	10.0	1.6	175	300	8	233	5
6415450	148 12	12.0	2.0	200	330	12	381	5
6415530	148 14	14.0	2.5	250	390	12	478	5

162

SCREWDRIVER for cross-slotted head screws PH

- ✔ Similar to DIN ISO 8764-2, tip acc. to DIN ISO 8764-1 PH
- ✔ Blade tanged right through the handle, chrome-plated
- ✔ GEDORE vanadium steel 50CrV4
- ✔ Hardwood handle, clear varnished with leather cap
- ✔ Hexagon bolster for extra power

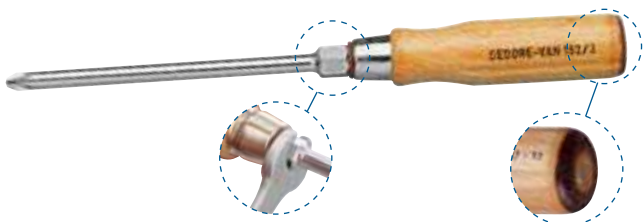

Code	No.	PH	M	mm	mm	mm	mm	mm
6429400	162 1	1	M 2 - M 3	80	180	6	58	5
6429590	162 2	2	M 3,5 - M 5	100	210	10	96	5
6429670	162 3	3	M 6	150	275	12	172	5
6429750	162 4	4	M 8 - M 10	200	340	17	325	5

147-04

SCREWDRIVER SET 4 pieces

- ✔ Work-orientated assortment packed in environmentally-friendly cardboard box
- ✔ Blade tanged right through the handle, chrome-plated
- ✔ GEDORE vanadium steel 50CrV4
- ✔ Hardwood handle, clear varnished with leather cap
- ✔ Hexagon bolster for extra power



Code	No.	Contents	mm	mm
6422820	147-04	⊖ 147 5,5 7 9 10	585	1

147-162-05

SCREWDRIVER SET 5 pieces

- ✔ Work-orientated assortment packed in environmentally-friendly cardboard box
- ✔ Blade tanged right through the handle, chrome-plated
- ✔ GEDORE vanadium steel 50CrV4
- ✔ Hardwood handle, clear varnished with leather cap
- ✔ Hexagon bolster for extra power

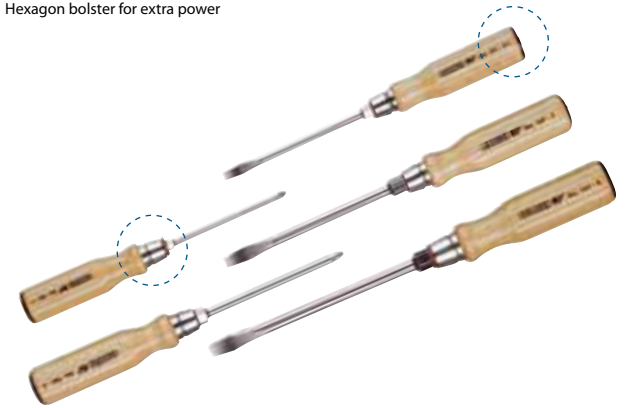

Code	No.	Contents	mm	mm
6423120	147-162-05	⊖ 147 5,5 7 9 ⊕ 162 1 2	535	1

ELECTRONIC SCREWDRIVER

171 IS

ELECTRONIC SCREWDRIVER for slotted head screws

- ✔ Blade in high-alloy chrome-vanadium-molybdenum steel, chrome-plated
- ✔ Tip additionally coated for highest precision and corrosion protection
- ✔ 2-component-handle in ergonomic design
- ✔ Pivoting end cap with micro anti-slip surface
- ✔ Colour coding of the drive type



Code	No.	mm _±	mm	mm	mm	mm	mm
1845004	171 IS 1,2	1.2	60	155	2,5	17	5
6436450	171 IS 1,5	1.5	60	155	2,5	14	5
1845012	171 IS 1,8	1.8	60	155	2,5	17	5
6438660	171 IS 2	2.0	60	155	2,5	17	5
1845020	171 IS 2,5	2.5	75	170	2,5	20	5
1845039	171 IS 3	3.0	100	195	3,0	23	5



165 PH

ELECTRONIC SCREWDRIVER for cross-slotted head screws PH

- Blade in high-alloy chrome-vanadium-molybdenum steel, chrome-plated
- Tip additionally coated for highest precision and corrosion protection
- 2-component-handle in ergonomic design
- Pivoting end cap with micro anti-slip surface
- Colour coding of the drive type



Code	No.	PH	mm	mm	mm	mm	mm	mm
1845047	165 PH 000	000		60	155	2,5	18	5
6442770	165 PH 00	00		60	155	2,5	16	5
6442930	165 PH 0	0	M1,6 - M2	60	155	3,0	18	5
1845055	165 PH 1	1	M2-M3	80	175	4,5	31	5

165-171-06

ELECTRONIC SCREWDRIVER SET 6 pieces

- For slotted head and cruciform head screws PH
- Blade in high-alloy chrome-vanadium-molybdenum steel, chrome-plated
- Tip additionally coated for highest precision and corrosion protection
- 2-component-handle in ergonomic design
- Pivoting end cap with micro anti-slip surface
- Colour coding of the drive type
- In plastic case
- With "Check-Tool-System": 2-colour plastic insert to check that the set is complete



Code	No.	Contents	mm	mm
1902849	165-171-06	⊕ 165 PH 000 00 0 ⊖ 171 IS 1,2 1,8 2,5	385	1



165 TX

ELECTRONIC SCREWDRIVER for recessed TORX® head screws

- Blade in high-alloy chrome-vanadium-molybdenum steel, chrome-plated
- Tip additionally coated for highest precision and corrosion protection
- 2-component-handle in ergonomic design
- Pivoting end cap with micro anti-slip surface
- Colour coding of the drive type
- TORX® = reg. trademark of Acument Intellectual Properties, LLC. USA



Code	No.	TX	mm	mm	mm	mm	mm	mm
1845098	165 TX T3	T3	M1,2 - M1,4	1.13	60	155	2,5	16
1845101	165 TX T4	T4	M1,4	1.29	60	155	2,5	16
1845128	165 TX T5	T5	M1,8	1.42	60	155	2,5	17
1845136	165 TX T6	T6	M2	1.69	60	155	3,0	19
1845144	165 TX T7	T7	M2,5	1.99	60	155	3,0	19
1845152	165 TX T8	T8	M2,5	2.31	60	155	3,0	19
1845160	165 TX T9	T9	M3	2.50	60	155	3,0	19
1845179	165 TX T10	T10	M3 - M3,5	2.74	60	155	3,0	20
1845187	165 TX T15	T15	M3,5 - M4	3.27	60	155	3,5	23
1845195	165 TX T20	T20	M4 - M5	3.86	80	175	4,0	29



165 TX-06

ELECTRONIC SCREWDRIVER SET 6 pieces

- For recessed TORX® head screws
- Blade in high-alloy chrome-vanadium-molybdenum steel, chrome-plated
- Tip additionally coated for highest precision and corrosion protection
- 2-component-handle in ergonomic design
- Pivoting end cap with micro anti-slip surface
- Colour coding of the drive type
- In plastic case
- With "Check-Tool-System": 2-colour plastic insert to check that the set is complete
- TORX® = reg. trademark of Acument Intellectual Properties, LLC. USA



Code	No.	Contents	mm	mm
1902857	165 TX-06	⊕ 165 TX T5 T6 T7 T8 T9 T10	415	1

164 IN

ELECTRONIC SCREWDRIVER for in-hex screws

- Blade in high-alloy chrome-vanadium-molybdenum steel, chrome-plated
- Tip additionally coated for highest precision and corrosion protection
- 2-component-handle in ergonomic design
- Pivoting end cap with micro anti-slip surface
- Colour coding of the drive type



Code	No.	IN	mm	mm	mm	mm	mm
1845063	164 IN 0,7	0,7	60	155	2,5	18	5
1845071	164 IN 0,9	0,9	60	155	2,5	18	5
6443150	164 IN 1,3	1,3	60	155	2,5	17	5
6443230	164 IN 1,5	1,5	60	155	2,5	17	5
6443310	164 IN 2	2,0	60	155	2,5	19	5
6443580	164 IN 2,5	2,5	60	155	3,0	16	5
6443740	164 IN 3	3,0	60	155	3,5	22	5

1021

ELECTRONIC SCREWDRIVER SET 7 pieces

- In plastic case



Code	No.	Contents	mm	mm
6601830	1021	⊖ 171 IS 1,2 1,5 2 ⊕ 165 PH 00 0 8305-2 8306-5	624	1



HEXAGON ALLEN KEYS

42 T

HEXAGON ALLEN KEY WITH T-HANDLE

for in-hex screws

- Blue handle with hanging hole
- GEDORE vanadium steel 61CrSiV5, chromated

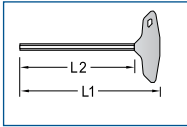

mm

Code	No.	mm	L ₁	L ₂	±	⊞
1531360	42 T 2	2.0	162.5	130	29	10
6354130	42 T 2,5	2.5	192.5	160	36	10
6353670	42 T 3	3.0	222.5	190	40	10
6353750	42 T 4	4.0	249.0	210	73	10
6353830	42 T 5	5.0	279.0	240	93	10
6353910	42 T 6	6.0	309.0	270	124	10
6366730	42 T 7	7.0	329.0	290	157	10
6354050	42 T 8	8.0	349.0	310	198	10
6354210	42 T 10	10.0	369.0	330	295	10



42 T

HEXAGON ALLEN KEY WITH T-HANDLE

for in-hex screws

- Blue handle with hanging hole
- GEDORE vanadium steel 61CrSiV5, chromated

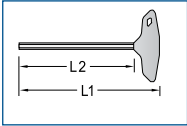

"AF"

Code	No.	AF	L ₁	L ₂	±	⊞
1996010	42 T 1/8AF	1/8	229	190	40	1
1996029	42 T 5/32AF	5/32	249	210	68	1
1996037	42 T 3/16AF	3/16	279	240	88	1
1996045	42 T 1/4AF	1/4	309	270	120	1
1996053	42 T 5/16AF	5/16	349	310	190	1
1996061	42 T 3/8AF	3/8	369	330	230	1



DT 42

HEXAGON ALLEN KEY WITH T-HANDLE for in-hex screws

- Blue handle with hanging hole
- With 2 hexagons, same size each end

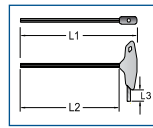

mm

Code	No.	mm	L ₁	L ₂	L ₃	±	⊞
1476408	DT 42 2	2.0	107.0	87	12.0	12	10
1476424	DT 42 2,5	2.5	127.0	107	12.0	15	10
1476432	DT 42 3	3.0	147.0	127	12.0	19	10
1476440	DT 42 4	4.0	173.5	141	15.5	49	10
1476459	DT 42 5	5.0	193.5	161	17.5	68	10
1476467	DT 42 6	6.0	213.5	181	20.5	91	10
1476475	DT 42 7	7.0	231.0	192	28.0	142	10
1476483	DT 42 8	8.0	246.0	207	28.0	175	10
1476491	DT 42 10	10.0	261.0	222	28.0	257	10

www.gedore.com

DTT 42

TRI-T HEXAGON ALLEN KEY for in-hex screws

- With 3 hexagons, same size each end
- T-handle fixed



mm

Code	No.	mm	L ₁	L ₂	Ø	±	⊞
1669540	DTT 42 3	3	150	75	5.0	42	1
1669559	DTT 42 4	4	180	90	6.0	64	1
1669567	DTT 42 5	5	180	90	7.0	92	1
1669575	DTT 42 6	6	210	105	8.0	134	1
1669583	DTT 42 8	8	250	125	9.5	224	1
1669591	DTT 42 10	10	300	150	12.0	418	1



Hexagon Allen Keys

- From GEDORE vanadium steel 61CrSiV5
- Self-designed/built machines from GEDORE's Special Machinery Construction section take up that precision-based manufacturing
- In a similar manner as with hot forging, the fibre course of the steel is not interrupted and thus retains its full strength, toughness and flexibility
- Professional tempering ensures a long service life
- Chamfered nose ends facilitate insertion into the screw head

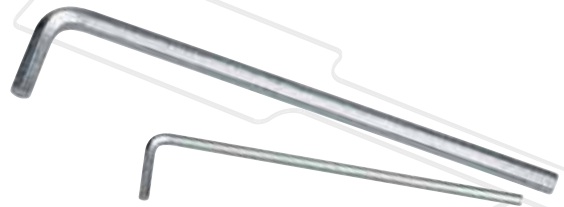

42

HEXAGON ALLEN KEY for in-hex screws

- Acc. to DIN ISO 2936
- GEDORE vanadium steel 61CrSiV5, zinc-plated up to size 12 mm, chrome-plated up from size 14 mm

mm

Code	No.	mm	L ₁	L ₂		
6342200	42 0,7	0.7	33.0	7.0	1	10
6342390	42 0,9	0.9	33.0	11.0	1	10
6342470	42 1,3	1.3	41.0	13.0	1	10
6340260	42 1,5	1.5	46.5	15.5	1	10
6340340	42 2 (5/64AF)	2.0	52.0	18.0	2	10
6340420	42 2,5	2.5	58.5	20.5	4	10
6340500	42 3	3.0	66.0	23.0	6	10
6340690	42 4	4.0	74.0	29.0	11	10
6340770	42 5	5.0	85.0	33.0	19	10
6344840	42 7/32AF (5,5MM)	5.56	82.0	32.0	22	10
6340850	42 6	6.0	96.0	38.0	31	10
6340930	42 7	7.0	102.0	41.0	44	10
6341070	42 8	8.0	108.0	44.0	61	10
6341150	42 9	9.0	114.0	47.0	81	10
6341230	42 10	10.0	122.0	50.0	106	10
6341310	42 12	12.0	137.0	57.0	169	10
6341580	42 14	14.0	154.0	70.0	266	10
6341660	42 17	17.0	177.0	80.0	430	10
6341740	42 19	19.0	199.0	89.0	602	10
6341820	42 22	22.0	222.0	102.0	907	10
6341900	42 24	24.0	248.0	114.0	1211	5
6342550	42 27	27.0	277.0	127.0	1711	5
6342630	42 30	30.0	315.0	142.0	2423	1
6342710	42 32	32.0	347.0	157.0	3010	1

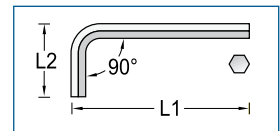

HEXAGON ALLEN KEY for in-hex screws

- GEDORE vanadium steel 61CrSiV5, zinc-plated up to size 1/2", chrome-plated up from size 9/16"

"AF

Code	No.	"AF	L ₁	L ₂		
6342120	42 3/64AF	3/64	41.0	13.0	2	10
6342040	42 1/16AF	1/16	46.5	15.5	2	10
6344330	42 3/32AF	3/32	56.5	20.5	4	10
6340340	42 2 (5/64AF)		52.0	18.0	2	10
6344410	42 1/8AF	1/8	60.0	23.0	6	10
6344680	42 5/32AF	5/32	67.0	26.0	10	10
6344760	42 3/16AF	3/16	73.0	30.0	15	10
6344840	42 7/32AF (5,5MM)	7/32	82.0	32.0	22	10
6344920	42 1/4AF	1/4	92.0	36.5	35	10
6345060	42 5/16AF	5/16	102.0	43.0	59	10
6345140	42 3/8AF	3/8	115.0	49.0	94	10
6345220	42 1/2AF	1/2	142.0	61.0	205	10
6345300	42 9/16AF	9/16	154.0	66.0	274	10
6345490	42 5/8AF	5/8	168.0	76.0	376	5
6345570	42 3/4AF	3/4	199.0	89.0	309	5





42 EL

HEXAGON ALLEN KEY for in-hex screws, extra long

- ▲ Acc. to DIN ISO 2936
- ▲ GEDORE vanadium steel 61CrSiV5, zinc-plated



mm

Code	No.	mm	L ₁	L ₂	mm	mm
6350810	42 EL 2 (5/64AF)	2.0	102.0	18.0	4	10
6351030	42 EL 2,5	2.5	114.5	20.5	7	10
6351110	42 EL 3	3.0	129.0	23.0	10	10
6351380	42 EL 4	4.0	144.0	29.0	19	10
6351460	42 EL 5	5.0	165.0	33.0	33	10
1543342	42 EL 7/32AF (5,5MM)	5.56	186.0	38.0	47	10
6351540	42 EL 6	6.0	186.0	38.0	54	10
6351620	42 EL 8	8.0	208.0	44.0	104	10
6351700	42 EL 10	10.0	234.0	50.0	184	10
6351890	42 EL 12	12.0	262.0	57.0	293	10
6351970	42 EL 14	14.0	294.0	70.0	453	10

HEXAGON ALLEN KEY for in-hex screws, extra long

- ▲ GEDORE vanadium steel 61CrSiV5, zinc-plated



Code	No.	AF	L ₁	L ₂	mm	mm
6350810	42 EL 2 (5/64AF)	5/64	102.0	18.0	4	10
1543377	42 EL 3/32AF	3/32	114.5	20.5	6	10
1543318	42 EL 1/8AF	1/8	129.0	23.0	11	10
1543326	42 EL 5/32AF	5/32	144.0	29.0	19	10
1543334	42 EL 3/16AF	3/16	165.0	33.0	30	10
1543342	42 EL 7/32AF (5,5MM)	7/32	186.0	38.0	47	10
1543369	42 EL 1/4AF	1/4	197.0	41.0	65	10
1543350	42 EL 5/16AF	5/16	208.0	44.0	103	10
1543385	42 EL 3/8AF	3/8	234.0	50.0	167	10
1543393	42 EL 1/2AF	1/2	277.0	63.0	355	10
1543407	42 EL 9/16AF	9/16	294.0	70.0	475	10

42 KEL

HEXAGON ALLEN KEY for in-hex screws, extra long, with ball end

- ▲ GEDORE vanadium steel 59CrV4, chrome-plated



mm

Code	No.	mm	L ₁	L ₂	mm	mm
1563556	42 KEL 1,5	1.5	91.5	15.5	3	10
6370090	42 KEL 2	2.0	102.0	18.0	4	10
6370170	42 KEL 2,5	2.5	114.5	20.5	6	10
6370250	42 KEL 3	3.0	129.0	23.0	10	10
6370330	42 KEL 4	4.0	144.0	29.0	19	10
6370410	42 KEL 5	5.0	165.0	33.0	33	10
6370680	42 KEL 6	6.0	186.0	38.0	53	10
1729241	42 KEL 7	7.0	197.0	41.0	76	10
6370760	42 KEL 8	8.0	208.0	44.0	103	10
6370840	42 KEL 10	10.0	234.0	50.0	179	10
6370920	42 KEL 12	12.0	262.0	57.0	287	10

42 Z

HEXAGON ALLEN KEY with pilot, for in-hex screws

- ▲ Acc. to DIN 6911
- ▲ Chrome-vanadium steel, zinc-plated
- ▲ * not standardised



mm

Code	No.	*	mm	L ₁	L ₂	mm	mm
6342980	42 Z 3		3	63	20	6	5
6343010	42 Z 4		4	70	25	10	5
6343280	42 Z 5		5	80	28	19	5
6343360	42 Z 6		6	90	32	31	5
6343440	42 Z 7	*	7	95	34	42	5
6343520	42 Z 8		8	100	36	58	5
6343600	42 Z 10		10	112	40	100	5
6343790	42 Z 12		12	125	45	162	5
6343870	42 Z 14		14	140	56	254	5
6343950	42 Z 17		17	160	63	418	1
6344090	42 Z 19		19	180	70	584	1

42

HEXAGON ALLEN KEY SET for in-hex screws

- ▲ In blue PVC wallet
- ▲ GEDORE vanadium steel 61CrSiV5, zinc-plated



mm

Code	No.	Contents	mm	mm
6347510	42-07	2 2,5 3 4 5 6 8	144	1
6349050	42-70	2,5 3 4 5 6 8 10	254	1
6347780	42-08	3 4 5 6 8 10 12 14	716	1
6347860	42-09	2 2,5 3 4 5 6 7 8 10	297	1

HEXAGON ALLEN KEY SET for in-hex screws

- ▲ In blue PVC wallet
- ▲ GEDORE vanadium steel 61CrSiV5, zinc-plated



Code	No.	Contents	mm	mm
6348750	42-07 A	5/64 3/32 1/8 5/32 3/16 7/32 1/4"	103	1
6348830	42-08 A	1/8 5/32 3/16 1/4 5/16 3/8 1/2 9/16"	731	1
6348910	42-09 A	5/64 3/32 1/8 5/32 3/16 7/32 1/4 5/16 3/8"	257	1





H 42 - H 42 KEL

HEXAGON ALLEN KEY SET for in-hex screws

- ▶ In blue plastic holder (LPDE)
- ▶ GEDORE vanadium steel 61CrSiV5, zinc-plated
- ▶ Execution KEL with ball end
- ▶ GEDORE vanadium steel 59CrV4, chromated



H 42-10



H 42 EL-88



H 42 KEL-88

mm

Code	No.	Contents	🔧	📦
1505408	H 42-10	1,3 1,5 2 2,5 3 4 5 6 8 10	259	1
1505416	H 42 EL-88	2 2,5 3 4 5 6 8 10	425	1
1523988	H 42 KEL-88	2 2,5 3 4 5 6 8 10	415	1

HEXAGON ALLEN KEY SET for in-hex screws

- ▶ In blue plastic holder (LPDE)
- ▶ GEDORE vanadium steel 61CrSiV5, zinc-plated

"AF"

Code	No.	Contents	🔧	📦
1505424	H 42-88 A	5/64 3/32 1/8 5/32 3/16 7/32 1/4 5/16"	172	1
1543555	H 42 EL-88 A	5/64 3/32 1/8 5/32 3/16 7/32 1/4 5/16"	300	1

PH 42-88

HEXAGON ALLEN KEY SET for in-hex screws

- ▶ In blue plastic holder
- ▶ GEDORE vanadium steel 61CrSiV5, zinc-plated



mm

Code	No.	Contents	🔧	📦
6352000	PH 42-88	2 2,5 3 4 5 6 8 10	245	1

S 42

HEXAGON ALLEN KEY SET for in-hex screws

- ▶ On key ring with quick release
- ▶ GEDORE vanadium steel 61CrSiV5, zinc-plated



mm

Code	No.	Contents	🔧	📦
6347430	S 42-07	2 2,5 3 4 5 6 8	162	1

HEXAGON ALLEN KEY SET for in-hex screws

- ▶ On key ring with quick release
- ▶ GEDORE vanadium steel 61CrSiV5, zinc-plated

"AF"

Code	No.	Contents	🔧	📦
6348160	S 42-09 A	5/64 3/32 1/8 5/32 3/16 7/32 1/4 5/16 3/8"	273	1



SCL 42

HEXAGON ALLEN KEY SET for in-hex screws

- ▶ In robust metal clip
- ▶ Execution K with ball end
- ▶ GEDORE vanadium steel 61CrSiV5, zinc-plated



mm

Code	No.	Contents	🔧	📦
6347350	SCL 42-70	2,5 3 4 5 6 8 10	360	1
6371140	SCL 42 K-70	2,5 3 4 5 6 8 10	361	1

HEXAGON ALLEN KEY SET for in-hex screws

- ▶ In robust metal clip
- ▶ GEDORE vanadium steel 61CrSiV5, zinc-plated

"AF"

Code	No.	Contents	🔧	📦
6354800	SCL 42-90 A	5/64 3/32 7/64 1/8 9/64 5/32 3/16 7/32 1/4"	260	1



42 TX

WRENCH KEY WITH T-HANDLE for recessed TORX® screws

- Blue handle with hanging hole
- Chrome-vanadium steel, blade chrome-plated, tip gun-metal finish
- TORX® = reg. trademark of Acument Intellectual Properties, LLC. USA

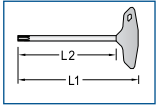

Code	No.	✳	ISO	mm	L ₁	L ₂	↕	☒
1531328	42 TX T5	T5	M1,8	1.42	107.0	87	18	10
1531336	42 TX T6	T6	M2	1.70	107.0	87	18	10
1531344	42 TX T7	T7	M2,5	1.99	107.0	87	18	10
1531352	42 TX T8	T8	M2,5	2.31	119.5	87	33	10
6361180	42 TX T9	T9	M3	2.50	139.5	107	38	10
6362070	42 TX T10	T10	M3 - M3,5	2.74	139.5	107	41	10
6362820	42 TX T15	T15	M3,5 - M4	3.27	159.5	127	42	10
6362900	42 TX T20	T20	M4 - M5	3.86	173.5	141	43	10
6365330	42 TX T25	T25	M4,5 - M5	4.43	180.0	141	64	10
6365410	42 TX T27	T27	M4,5 - M6	4.99	200.0	161	84	10
6365680	42 TX T30	T30	M6 - M7	5.52	200.0	161	90	10
6365760	42 TX T40	T40	M7 - M8	6.65	220.0	181	115	5
6365840	42 TX T45	T45	M8 - M10	7.82	231.0	192	139	5
6365920	42 TX T50	T50	M10	8.83	246.0	207	181	5

43 TX

CRANKED WRENCH KEY for recessed TORX® screws

- Chrome-vanadium steel 50CrV4, gun-metal finish
- TORX® = reg. trademark of Acument Intellectual Properties, LLC. USA

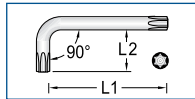

Code	No.	✳	ISO	mm	L ₁	L ₂	↕	☒
6363550	43 TX T6	T6	M2	1.69	42	16	3	5
6363630	43 TX T7	T7	M2,5	1.99	48	16	3	5
6363710	43 TX T8	T8	M2,5	2.31	48	16	4	5
6363980	43 TX T9	T9	M3	2.50	48	16	4	5
6364010	43 TX T10	T10	M3 - M3,5	2.74	51	17	5	5
6364280	43 TX T15	T15	M3,5 - M4	3.27	54	18	6	5
6364360	43 TX T20	T20	M4 - M5	3.86	57	19	8	5
6364440	43 TX T25	T25	M4,5 - M5	4.43	60	20	10	5
6364520	43 TX T27	T27	M4,5 - M6	4.99	64	21	16	5
6364600	43 TX T30	T30	M6 - M7	5.52	70	24	22	5
6364790	43 TX T40	T40	M7 - M8	6.65	76	26	31	5
6364870	43 TX T45	T45	M8 - M10	7.82	83	29	46	5
6364950	43 TX T50	T50	M10	8.83	95	32	60	5
6365090	43 TX T55	T55	M12	11.22	108	35	122	1
6365170	43 TX T60	T60	M14	13.25	120	38	187	1

VDE 42



505

43 KTX

CRANKED WRENCH KEY for recessed TORX® screws, with ball end

- Working angle approx. 25°
- Chrome-vanadium steel, gun-metal finish
- TORX® = reg. trademark of Acument Intellectual Properties, LLC. USA



Code	No.	✳	ISO	mm	L ₁	L ₂	↕	☒
6367110	43 KTX T10	T10	M3 - M3,5	2.74	73	17	6	5
6367380	43 KTX T15	T15	M3,5 - M4	3.27	83	17	9	5
6367460	43 KTX T20	T20	M4 - M5	3.86	94	18	12	5
6367540	43 KTX T25	T25	M4,5 - M5	4.43	96	18	15	5
6367620	43 KTX T27	T27	M4,5 - M6	4.99	106	20	24	5
6367700	43 KTX T30	T30	M6 - M7	5.52	119	24	33	5
6367890	43 KTX T40	T40	M7 - M8	6.65	132	26	49	5

43 TX-09

CRANKED WRENCH KEY SET for recessed TORX® screws

- In blue PVC wallet
- Chrome-vanadium steel 50CrV4, gun-metal finish
- TORX® = reg. trademark of Acument Intellectual Properties, LLC. USA



Code	No.	Contents	↕	☒
6360960	43 TX-09	T7 T8 T9 T10 T15 T20 T25 T30 T40	115	1

H 43 TX - H 43 KTX

CRANKED WRENCH KEY SET for recessed TORX® screws

- In blue LDPE holder
- Execution KTX with ball end
- Chrome-vanadium steel 50CrV4, gun-metal finish
- TORX® = reg. trademark of Acument Intellectual Properties, LLC. USA

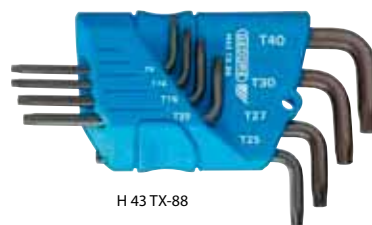

H 43 TX-88



H 43 KTX-07

Code	No.	Contents	↕	☒
1531417	H 43 TX-09	T7 T8 T9 T10 T15 T20 T25 T30 T40	120	1
1531425	H 43 TX-88	T9 T10 T15 T20 T25 T27 T30 T40	129	1
1531433	H 43 TX-08	T10 T15 T20 T25 T27 T30 T40 T45	168	1
1531441	H 43 KTX-07	T10 T15 T20 T25 T27 T30 T40	169	1



SCL 43 TX-80

CRANKED WRENCH KEY SET for recessed TORX® screws

- ▶ In robust metal clip
- ▶ TORX® = reg. trademark of Acument Intellectual Properties, LLC. USA



Code	No.	Contents	🔧	📦
6346460	SCL 43 TX-80	T9 T10 T15 T20 T25 T27 T30 T40	286	1

DT 43 KTX

CRANKED WRENCH KEY WITH T-HANDLE for recessed TORX® screws

- ▶ Working angle approx. 25°
- ▶ Blue handle with hanging hole
- ▶ Chrome-vanadium steel, blades chrome-plated, tip phosphated
- ▶ TORX® = reg. trademark of Acument Intellectual Properties, LLC. USA

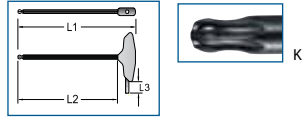
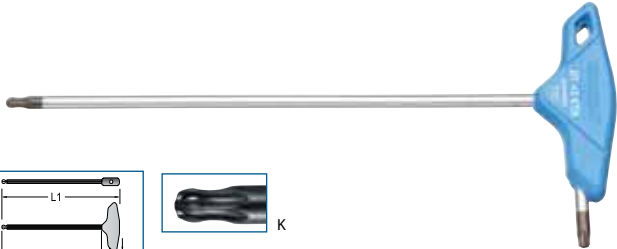

Code	No.	🔧	📏	mm	L ₁	L ₂	L ₃	🔧	📦
1505521	DT 43 KTX T10	T10	M3 - M3,5	2.74	150.0	130	12.0	24	1
1505548	DT 43 KTX T15	T15	M3,5 - M4	3.27	170.0	150	12.0	27	1
1505556	DT 43 KTX T20	T20	M4 - M5	3.86	202.5	170	15.5	58	1
1505564	DT 43 KTX T25	T25	M4,5 - M5	4.43	222.5	190	17.5	67	1
1505572	DT 43 KTX T27	T27	M4,5 - M6	4.99	242.5	210	20.0	94	1
1505580	DT 43 KTX T30	T30	M6 - M7	5.52	279.0	240	28.0	126	1
1505599	DT 43 KTX T40	T40	M7 - M8	6.65	309.0	270	28.0	171	1



708

TORX® GAUGE

- ▶ Easy identification of TORX® sizes, internal E4-E16, external T10-T60
- ▶ TORX® = reg. trademark of Acument Intellectual Properties, LLC. USA



Code	No.	Contents	🔧	📦
1394428	708	🔧 E4 - E16 📏 T10 - T60	22	1

Deviant packing units see article description.

42 X

CRANKED ALLEN SOCKET SCREWDRIVER

- for multi-point screws INBUS®XZN
- ▶ Acc. to DIN 65253, tips acc. to DIN 2325
- ▶ GEDORE vanadium steel 50CrV4, chromated

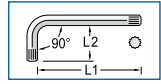
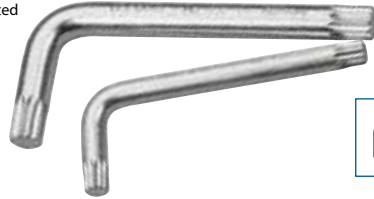

Code	No.	📏	L ₁	L ₂	🔧	📦
1531212	42 X 4	M 4	63	20	9	5
6350060	42 X 5	M 5	75	30	15	5
6350140	42 X 6	M 6	86	34	25	5
6350220	42 X 8	M 8	98	40	43	5
6350300	42 X 10	M 10	110	46	85	5
6350490	42 X 12	M 12	124	52	124	5
6350570	42 X 14	M 14	139	59	191	5
6350650	42 X 16	M 16	156	72	308	5
6350730	42 X 18	M 18	178	81	333	1



43

CRANKED WRENCH KEY for multi-spline screws RIBE®

- ▶ GEDORE vanadium steel 50CrV4, chromated
- ▶ RIBE® = reg. trademark of Richard Bergner GmbH & Co. KG, Schwabach, Germany

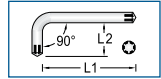

Code	No.	📏	L ₁	L ₂	🔧	📦
6352270	43 5	M 5	71	25	16	5
6352350	43 6	M 6	80	28	25	5
6352430	43 8	M 8	90	32	49	5
6352510	43 10	M 10	100	36	84	5
6352780	43 12	M 12	112	40	135	5
6352860	43 14	M 14	125	45	203	5

173

CRANKED SCREWDRIVER for slotted head screws

- ▶ Acc. to DIN 5200, blade tips acc. to DIN ISO 2380-2
- ▶ Chrome-vanadium steel, matt nickel-plated



Code	No.	mm; 📏	mm; 📏	🔧	📦
6437180	173 3,5	3.5	0.6	90	10
6437850	173 4	4.0	0.8	100	13
6436100	173 5,5	5.5	1.0	125	25
6436370	173 8	8.0	1.2	150	50
6437930	173 10	10.0	1.6	175	87
6436530	173 12	12.0	2.0	200	127

174

CRANKED SCREWDRIVER for cross-slotted head screws PH

- ▶ Acc. to DIN 5208, tips acc. to DIN ISO 8764-1 PH
- ▶ Chrome-vanadium steel, matt nickel-plated



Code	No.	PH	📏	🔧	📦
6436880	174 1	1-2	M2 - M5	100	29
6436960	174 3	3-4	M6 - M10	200	121



TORQUE SCREWDRIVER

2140

TORQUE SCREWDRIVER HANDLE 0,6-5,4 N-m

- Adjustable, with tactile impulse and audible signal
- For guaranteed controlled screw tightening in the range of 0,6 - 5,4 N-m
- With test certificate acc. to DIN EN ISO 6789, traceable to national standards
- Including hexagon socket key set 42 6 mm
- Actuation accuracy:
 - model 2140 1,5 NM: +/- 10% tolerance of the set value
 - model 2140 3,0 NM and 2140 5,4 NM: +/- 6% tolerance of the set value



Code	No.	Nm	↳mm↳	↳mm↳	↳mm↳	↳mm↳
1802364	2140 1,5 NM	0,6-1,5	108	0,1	145	1
1802372	2140 3,0 NM	1,5-3,0	108	0,1	147	1
1802380	2140 5,4 NM	3,0-5,4	108	0,2	152	1

2141 IS

PLUG-IN BLADE 1/4" HEX for slotted head screws



Code	No.	mm:↳	mm:◀	↳mm↳	↳mm↳	↳mm↳
1802453	2141 IS 3	3.0	0.5	170	42	1
1802461	2141 IS 3,5	3.5	0.6	170	43	1
1802488	2141 IS 4	4.0	0.8	170	43	1

2141 PH

PLUG-IN BLADE HEX for cross-slotted head screws PH



Code	No.	PH	↳mm↳	↳mm↳	↳mm↳
1802496	2141 PH 0	0	M1,6 - M2	170	42
1802518	2141 PH 1	1	M2 - M3	170	44
1802526	2141 PH 2	2	M3,5 - M5	170	46



Accessories

Activating tools and screwdriver bits as well as adaptors are listed up from page



227 - 228

2141 PZ

PLUG-IN BLADE HEX for cross-slotted head screws PZ



Code	No.	PH	↳mm↳	↳mm↳	↳mm↳
1802534	2141 PZ 0	0	M1,6 - M2	170	42
1802542	2141 PZ 1	1	M2 - M3	170	44
1802550	2141 PZ 2	2	M3,5 - M5	170	46

2141 TX

PLUG-IN BLADE 1/4" HEX for recessed TORX® head screws

▶ TORX® = reg. trademark of Acument Intellectual Properties, LLC. USA



Code	No.	PH	↳mm↳	↳mm↳	↳mm↳	↳mm↳
1802569	2141 TX T6	T6	M2	1.69	170	42
1802577	2141 TX T7	T7	M2,5	1.99	170	42
1802585	2141 TX T8	T8	M2,5	2.31	170	42
1802593	2141 TX T9	T9	M3	2.50	170	42
1802607	2141 TX T10	T10	M3 - M3,5	2.74	170	42
1802615	2141 TX T15	T15	M3,5 - M4	3.27	170	44
1802623	2141 TX T20	T20	M4 - M5	3.86	170	45
1802631	2141 TX T25	T25	M4,5 - M5	4.43	170	46



2141 IP

PLUG-IN BLADE 1/4" HEX for recessed TORX PLUS® head screws

▶ TORX PLUS® = reg. trademark of Acument Intellectual Properties, LLC. USA



Code	No.	PH	↳mm↳	↳mm↳	↳mm↳
1802658	2141 6IP	M2	170	42	1
1802666	2141 7IP	-	170	42	1
1802674	2141 8IP	M2,5 - M3	170	42	1
1802682	2141 9IP	-	170	42	1
1802690	2141 10IP	M3 - M3,5	170	42	1
1802704	2141 15IP	M3,5 - M4	170	44	1



2140

TORQUE SCREWDRIVER SET 25 pieces

- Ideal for working in a small torque range, e.g. electronics, precision mechanics
- GEDORE-Check-Tool system
- For screwdriver function simply add the 2C multi-handle with appropriate accessory
- Adjustable, with tactile impulse and audible signal
- For guaranteed controlled screw tightening in the range of 1,5-3 / 3-5,4 N-m
- With test certificate acc. to DIN EN ISO 6789, traceable to national standards
- Actuation accuracy: +/- 6% tolerance of the set value
- Delivered with test certificate and operating instructions



Code	No.	Contents	N-m	mm	mm	mm
1953761	2140-3,0-025	<ul style="list-style-type: none"> 680 4 6,5 685 2 2,5 3 4 5 6 690 0 1 2 D 20 4 4,5 5 5,5 6 7 8 9 10 42 6 673 L 676 699 L 	1,5-3,0	595	1	
1802429	2140-5,4-025	<ul style="list-style-type: none"> 680 4 6,5 685 2 2,5 3 4 5 6 690 0 1 2 D 20 4 4,5 5 5,5 6 7 8 9 10 42 6 673 L 676 699 L 	3,0-5,4	595	1	



For further models see product group Torque Tools 755 / 756



258 - 259

VOLTAGE TESTER

4610

CAR LIGHT TESTER

- For testing 6-24 Volt
- Compact brass model
- With cable and alligator crimp



Code	No.	mm	mm	mm	mm
6698570	4610	125	69	10	

4611

VOLTAGE TESTER

- For 6-24 Volt
- With cable and alligator crimp



Code	No.	mm	mm	mm	mm
6698650	4611	3	55	115	26

4615

VOLTAGE TESTER

- For 220-250 Volt AC
- Blade nickel-plated, fully insulated blade conforming to DIN VDE 0680-6
- Handle and insulation in GEDORE blue
- 4615 3 with metal clip and grey cap



Code	No.	mm	mm	mm	mm	mm
6699110	4615 3	0.5	3.0	60	140	22
6699380	4615 3,5	0.6	3.5	90	180	37

VARIOUS

149

MAGNETIZER AND DEMAGNETIZER

- Magnetizes or demagnetizes screwdrivers, tweezers and similar tools made from steel
- Blue housing, made from high-quality plastic, unbreakable, cadmium-free



Code	No.	L	H	W	mm	mm
6416500	149	52	26	50	88	1

156 S

SQUARE BLADED AWL

- Blue handle with hanging hole
- Blade bright nickel-plated



Code	No.	mm	mm	mm	mm
6424520	156 S	100	200	84	10



182 ± 3

18

A

58⁺¹_{-1.5}

46.2⁺¹_{-1.6}

max. 2.5

F

Ø 5

Ø 4.5

Ø 4

23⁺¹

1

Schweine-Industry
Gefährdet: 62-64HRC

3

0525

CRIMP



B

2

0.3 ± 0.05



PLIERS RANGE



TAKE A FIRM GRIP

++ STRONG AND FIRM +



SERVICE / FEATURES		308 - 312
COMBINATION PLIERS		313 - 315
SIDE CUTTERS / END CUTTING NIPPERS		316 - 318
FLAT NOSE / ROUND NOSE PLIERS		319 - 321
MECHANICS PLIERS		322
BOWDEN CABLE CUTTER / CABLE SHEARS		323
ELECTRONIC PLIERS		324
ACCESSORIES		325 - 331
STRIPPING TOOLS		332
CRIMPING PLIERS		332 - 334
CIRCLIP PLIERS (X-GRIP)		334 - 339
GRIP WRENCHES		340 - 345
PIPE WRENCHES		346 - 348
BOLT CUTTERS		348
WATER PUMP / UNIVERSAL		349
PLIERS		350 - 351
PLIERS ASSORTMENTS		352 - 357





GEDORE PLIERS



GEDORE PLIERS: + EVERYTHING HANDLED SECURELY

- Use of the best-possible steels, most up-to-date machinery and environmentally-friendly production processes
- Our tool specialists vouch for exactness in processing and continuous refinements
- Unique manufacturing processes and special tool treatment bring about the best in results
- Stringent quality checks after each production step ensure a constantly high level
- Professional service up to the development of special customised tools



+ PRECISION, DIMENSIONED ACCURACY AND EXACTNESS OF FITTING

- High-grade industrial quality for the toughest forms of continuous use and safety in everyday work
- High bending stiffness thanks to GEDORE special hardened and tempered steel. GEDORE pliers do not fracture or splinter when overloaded but deform under incorrect use, therefore posing a lower risk of injury to the user
- GEDORE pliers rest comfortably in the hand (M/ML/XXL) - the most important requirement, in fact, for non-taxing and safe working

+ INTELLIGENTLY DESIGNED OR THE MIN-MAX PRINCIPLE

- Benefits in practical application from optimum utilization made of the laws of leverage.
- Maximum power transfer of the pliers with a minimum effort required
- For the pliers this means: optimum transfer of power - very high cutting performance
- For those using the pliers this means: precise, fatigue-free and ergonomic working
- The specially developed "power pliers": "Symbol K" stands up well particularly in hard continuous operations (higher clamping forces with up to 35% less effort exerted)

+ THE COMPLETE RANGE: FORM AND FUNCTION PERFECTION

- Extremely wide selection in sizes, finish and grip designs for specialists and non-specialists alike
- Model JC = chrome-plated, 2-component handle protectors
- Model TL = black with blue dipped handle protector
- Available individually or in practical sets, in the module or in assortments



- On request also available with SB pack (plastic hanging clip, Euro perforation for self-service display wallboard)



FOR 8250 COMBINATION PLIERS ++



1 Blank cropped to size from C50 hardened and tempered steel.

2 Hot forged in the double forging die. The excess burr is removed under an eccentric press.



3 The blanks are "normalised" to obtain an even finer-grain, more uniform structure with optimum strength. After descaling, the blanks are calibrated for the following work steps.



4 The head is machined in a CNC-controlled machining centre. The rivet hole is drilled and counter-bored. The joint clearance and the outer contour are milled. The geometry of the joint area and the coarse and fine toothings are broached.



5 The joint faces are precision milled. The pliers head takes on its final form.



6 The moving and fixed pliers legs are riveted together. A smooth-moving joint with no play is the essential requirement for safe one-handed operation.



7 In a chamber hardening kiln, the pliers are hardened in a protective gas atmosphere, quenched in oil and finally annealed. The design of the hardening kiln ensures that the process gases are uniformly distributed, which has a positive effect on the desired material properties.

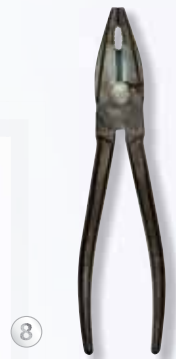

8 The cutting edges of GEDORE pliers are once again induction hardened. The additional hardness that this achieves ensures a good cutting performance and a long life between sharpening.



VDE pliers are subjected to an individual test in accordance with DIN EN 60900 / IEC 60900:2004. GEDORE Austria has been a certified manufacturing plant for VDE protective insulated pliers since 2003.



9 The pliers head is ground to achieve a flush geometry.



10 The surface is cleaned by sand blasting. The removal of scale and grease is necessary for the follow-on electroplating process.



11 Nickel-plated and matt-chrome-plated to prevent dazzle. The electrolytically deposited nickel coating provides the corrosion protection. The electroplated chrome improves the look and gives the pliers a perfect finish.



12 TL pliers are painted black by a robot, using water soluble paint.



13 The 2-component handles are pressed on and bonded.



14 The plastic coating on the handles is built up by multiple dipping in liquid immersion compound.



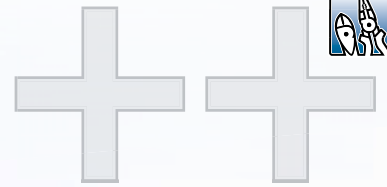

TECHNICAL FEATURES

POSITION OF THE CUTTING EDGES AS PER DIN ISO 5742

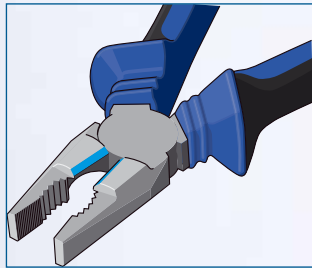
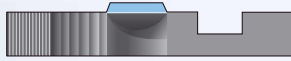

 Cutting edge - convex
For flush cutting.

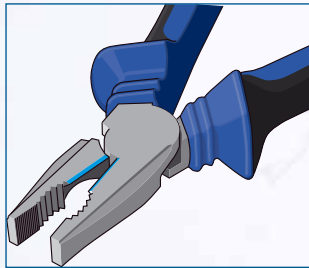

Cutting edge - inner
Flush cutting not possible.

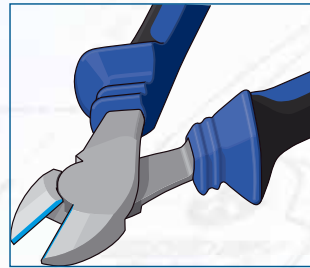

Side cutters
For effort-saving cutting a number of times. For flush cutting.

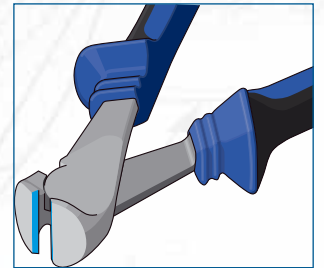
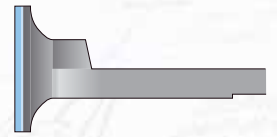

End cutting nippers
For effort-saving cutting a number of times. E.g. meadow wire fencing. For flush cutting.

JOINT TYPES

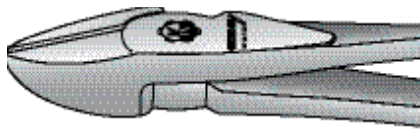

lap joint

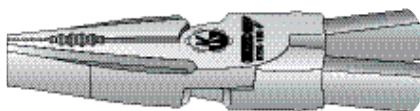

inserted joint

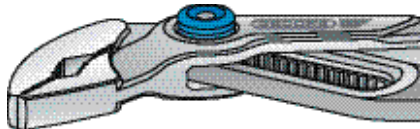

safety-box joint

CUTTING FORMS AS PER DIN ISO 5742

 Cutting without cutting bevel (without chamfer)

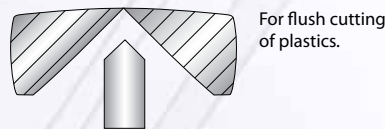

 Cutting with a slight cutting bevel (small degree of chamfer)

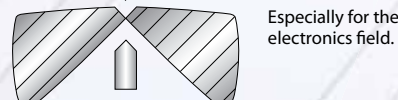

 Cutting with cutting bevel (with chamfer)

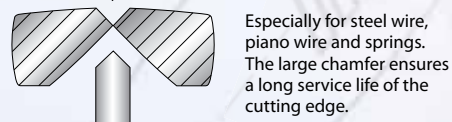

BASIC JAW FORMS

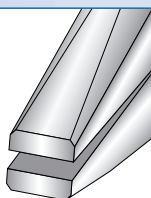

flat jaws

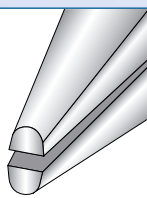

flat/round jaws

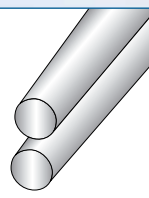

round jaws



CARE NOTE

An occasional drop of oil on the joint will ensure that your pliers have a long life.



WIRE CATEGORIES

	Material examples	Wire type	Tensile strength N/mm ²
	Copper, plastic	soft	220
	Nail, wire nail	medium-hard	750
	Wire rope fibre, steel	wire hard	1800
	Spring-steel wire	Piano wire	2300



POWER PLIERS

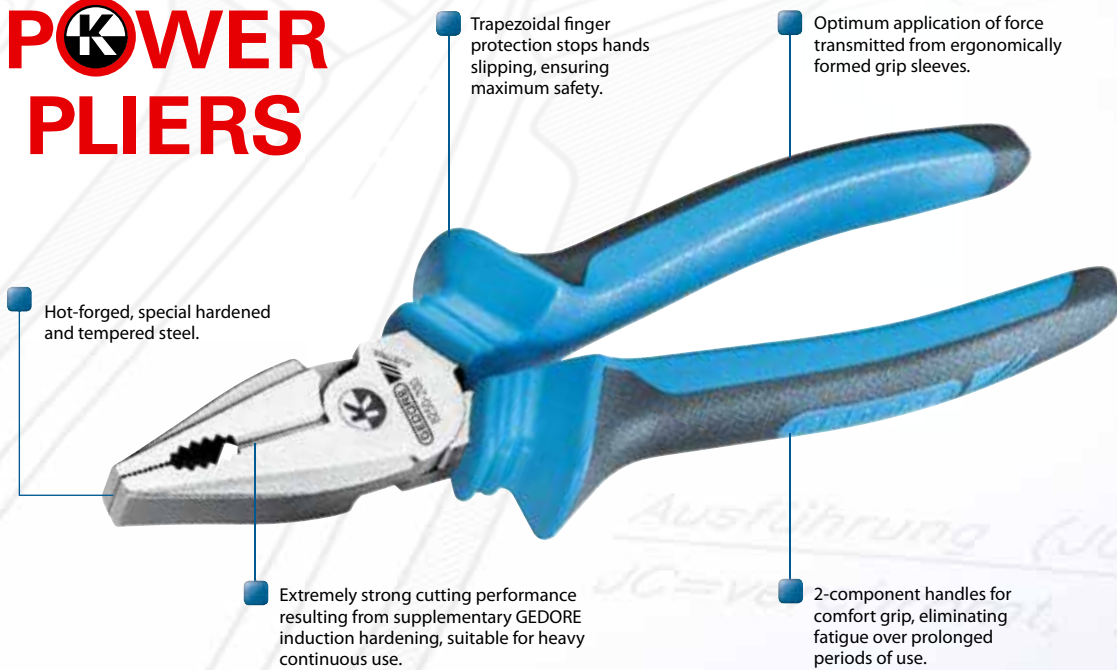

FORCE EQUATION

$$\Sigma M (\text{rivet}) = 0 = F(\text{hand}) \times L(\text{hand}) = F(\text{cutting edges}) \times L(\text{optimum cutting edge distance})$$

The eccentric pivot point ensures that the hand torque (force x path) applied over the rivet (fulcrum) is effectively and positively translated into cutting force.

$$F(\text{cutting edges}) = \frac{F(\text{hand}) \times L(\text{hand})}{L(\text{optimum cutting edge distance})}$$

The greatly improved effective length of this design achieves increased cutting force. Optimised lever ratios bring a 35% reduction in the effort required.

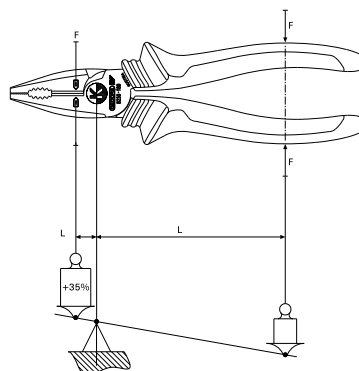

WORKING PRINCIPLE

POWER PLIERS

"K" identifies the GEDORE Power Pliers range, offering increased cutting and gripping force with up to 35% less effort.

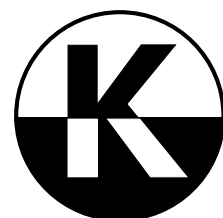



THE GREAT PLIERS RANGE



 **VDE INSULATED SAFETY TOOLS**

 **501 - 515**

 **PLIER ASSORTMENTS**

 **352 - 357**



 **ES-TOOL MODULES**

 **85 - 89**

 **CT-TOOL MODULES**

 **90 - 93**

 **On application**



PLIERS



- Wear protective goggles when working with pliers! Ejected bits of wire and circlips not correctly positioned in the tip of the pliers pose a risk to your eyes!
- Check on the jaws for wear and tear! Worn jaws result in slipping and thus in accidents.
- The joint of the pliers is not to have any noticeable play! Exceptions are the sliding joints.
- When cutting wire, choose pliers that match the wire diameter and wire hardness!
- Never use pliers as hammers!
- Only insulated and tested pliers are to be used when working on electrical equipment!
- Grip wrenches are only for briefly fixing workpieces!



COMBINATION PLIERS



8248 Angled combination pliers

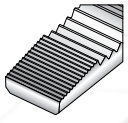

Gripping faces with file-cut for safe holding

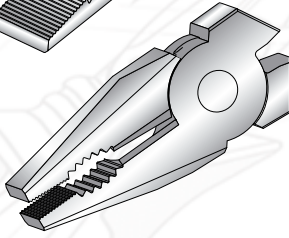

Specially offset teeth in the grip surfaces for best-possible gripping on pipes and screws

Induction-hardened cutting edges (63-65 HRC)

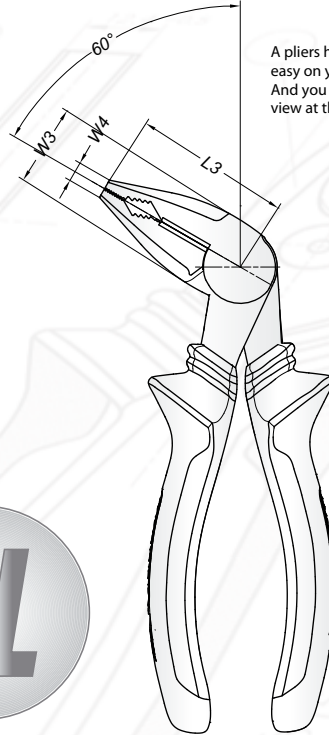

A pliers head angled at 60° goes easy on your joints and tendons. And you keep the workpiece in view at the same time

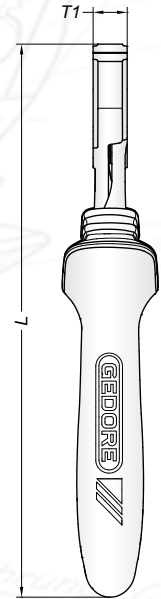

8248

ANGLED COMBINATION PLIERS

- For the toughest of demands
- Combination pliers with a 60° angled pliers head
- Optimum utilization of the power in one's hands
- No forced positioning of the hand.
- Fatigue-free working over a long period made possible.
- High-grade GEDORE special hardened and tempered steel for high cutting performance and a long service life
- Induction-hardened precision cutting edges, hardness 63-65 HRC
- For all wires including piano wire
- Hot-drop forged
- Inserted joint for a stable connection of the two legs
- JC = chrome-plated, 2-component handle protectors
- TL = clear varnished, with blue dipped non-slip handles

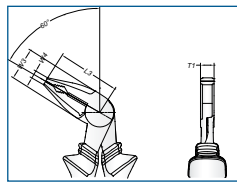
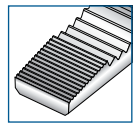

Code	No.	L	L ₃	W ₃	W ₄	T ₁		
2276585	8248-160 JC	165	46	24	6	10	245	1
2276763	8248-160 TL	165	46	24	6	10	220	1



S 8003 JC



352





8200

SMALL COMBINATION PLIERS

- ▶ Practical small combination pliers especially for confined spaces or as car-boot tool
- ▶ For flat and round material
- ▶ Similar to DIN ISO 5746
- ▶ GEDORE special hardened and tempered steel, drop-forged, oil-hardened and annealed
- ▶ JCP = chrome-plated, with 2-component handle protectors

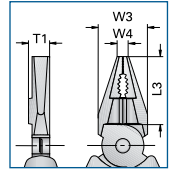
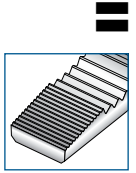

Code	No.	L	L ₃	W ₃	W ₄	T ₁	↕	☰
6730480	8200-125 JCP	125	25	16	3.2	7.6	117	1

8210

COMBINATION PLIERS German pattern

- ▶ Acc. to DIN ISO 5746
- ▶ Reinforced type, for tough continuous operations
- ▶ Lay-on cutter box
- ▶ For flat and round material
- ▶ For medium-hard and hard wire
- ▶ Induction-hardened precision cutting edges, hardness 62-64 HRC
- ▶ GEDORE special hardened and tempered steel, drop-forged, oil-hardened and annealed
- ▶ JC = chrome-plated, 2-component handles
- ▶ TL = black, with blue dipped handle protectors

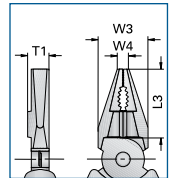
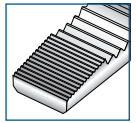
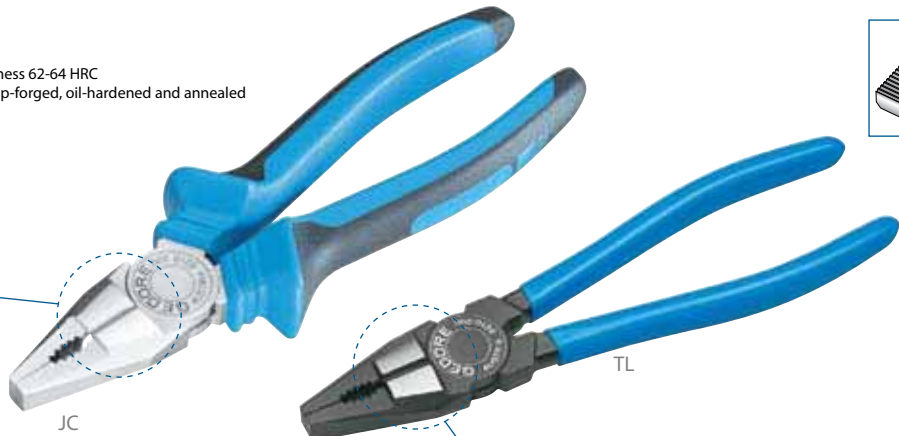

Code	No.	L	L ₃	W ₃	W ₄	T ₁	↕	☰
6731100	8210-160 JC	160	34	23.0	5.8	10.8	217	5
6711340	8210-160 TL	160	34	23.0	5.8	10.8	173	5
6731530	8210-180 JC	180	38	27.0	6.4	11.8	284	5
6711420	8210-180 TL	180	38	27.0	6.4	11.8	227	5
6732180	8210-200 JC	200	42	29.5	7.4	12.5	356	5
6711850	8210-200 TL	200	42	29.5	7.4	12.5	296	5

8245

COMBINATION PLIERS Euro pattern

- ▶ Acc. to DIN ISO 5746
- ▶ Universal model with slimline head, ideal for confined spaces
- ▶ Induction-hardened precision cutting edges, hardness 62-64 HRC
- ▶ For flat and round material
- ▶ For medium-hard and hard wire
- ▶ GEDORE special hardened and tempered steel, drop-forged, oil-hardened and annealed
- ▶ JC = chrome-plated, 2-component handles
- ▶ TL = black, with blue dipped handle protectors

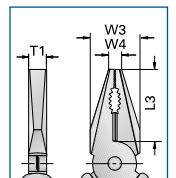
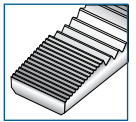

Code	No.	L	L ₃	W ₃	W ₄	T ₁	↕	☰
6733070	8245-160 JC	160	34	23.0	5.8	8.8	218	5
6730050	8245-160 TL	160	34	23.0	5.8	8.8	174	5
6733150	8245-180 JC	180	38	27.0	6.4	9.8	280	5
6730210	8245-180 TL	180	38	27.0	6.4	9.8	230	5
6733230	8245-200 JC	200	42	29.5	7.4	10.5	363	5
6730720	8245-200 TL	200	42	29.5	7.4	10.5	297	5



8250 Power combination pliers

Maximum cutting performance yet with a low level of effort expended thanks to an optimum interaction of cutting geometry, eccentric rivet bearing and ergonomic handle design.



Inductively hardened cutting edges (62-64 HRC) ensure constant cutting power over a long time span.

High-grade 2-component handles with finger protection enable work to be done ergonomically and to the exclusion of tiredness

Roughly toothed gripping surfaces for securely holding screws, pipes etc.

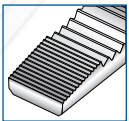

Gripping surface with file-cut for a particularly effective hold



Power pliers: The effort required in using them is down 35% on account of the pivot transferred to the front and the resulting lengthened lever.



VDE 8250



508



NC 8210



495

8250

POWER COMBINATION PLIERS

- Acc. to DIN ISO 5746
- For heavy continuous use
- Good lever action for easy cutting
- Induction-hardened precision cutting edges, hardness 62-64 HRC
- For flat and round material
- To cut all wire types including piano wire
- GEDORE special hardened and tempered steel, drop-forged, oil-hardened and annealed
- JC = chrome-plated, 2-component handles
- TL = black, with blue dipped handle protectors

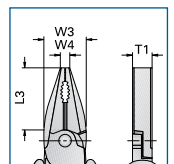
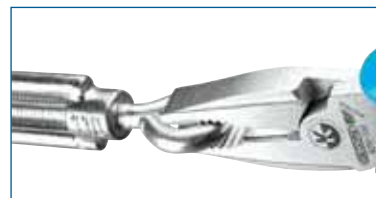
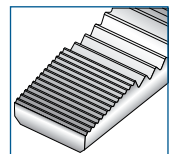

Code	No.	L	L ₂	W ₁	W ₂	T ₁	↕	↕
1429566	8250-160 JC	160	35.0	22.8	5.8	10.4	225	5
1429574	8250-160 TL	160	35.0	22.8	5.8	10.4	180	5
6707070	8250-180 JC	180	38.5	25.6	6.5	11.0	282	5
6707660	8250-180 TL	180	38.5	25.6	6.5	11.0	227	5
6707310	8250-200 JC	200	39.5	27.0	6.5	12.4	360	5
6707740	8250-200 TL	200	39.5	27.0	6.5	12.4	288	5
6708040	8250-225 TL	225	42.2	27.7	6.5	13.0	351	1



1500 ES

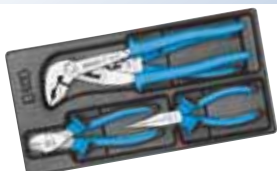

87



S 8003 JC



352



1500 CT



92



SIDE CUTTERS / END CUTTING NIPPERS

8313

SIDE CUTTER for plastic

- ✔ Without cutting edge bevel, for flush cutting of plastic parts
- ✔ Black, cutting faces flat-ground, with compression spring for automatic opening
- ✔ With blue dipped handle protectors (TL)

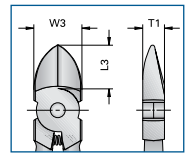

Code	No.	L	L ₃	W ₃	T ₁	↕	☑
6745910	8313-125 TL	125	16.0	17.0	8.5	116	1
6746050	8313-140 TL	140	18.5	18.5	9.5	131	1
6746130	8313-160 TL	160	19.0	22.0	10.0	184	1



8314

SIDE CUTTER Swedish pattern

- ✔ Acc. to DIN ISO 5749
- ✔ With slender head - ideal for confined spaces
- ✔ For medium-hard wire
- ✔ Induction-hardened precision cutting edges, hardness 63-65 HRC
- ✔ Max. cutting capacity Ø 1.6 mm
- ✔ GEDORE special hardened and tempered steel, drop-forged, oil-hardened and annealed
- ✔ JC = chrome-plated, 2-component handles
- ✔ TL = black, with blue dipped handle protectors

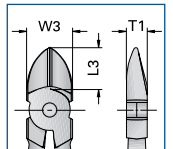

Code	No.	L	L ₃	W ₃	T ₁	Ø	↕	☑
6742300	8314-125 JC	125	16.0	17.0	8.5	1,6	146	5
6740870	8314-125 TL	125	16.0	17.0	8.5	1,6	107	5
6742730	8314-140 JC	140	18.5	18.5	9.5	1,6	176	5
6740950	8314-140 TL	140	18.5	18.5	9.5	1,6	129	5
6743380	8314-160 JC	160	19.0	22.0	10.0	1,6	230	5
6741090	8314-160 TL	160	19.0	22.0	10.0	1,6	173	5



TL

8315

ELECTRICIANS' SIDE CUTTER

- ✔ Double-function electricians' side cutters: for cutting and stripping wire
- ✔ Stripping notches for single and multi-strand wire, 1,5 mm² and 2,5 mm² conductor cross-section
- ✔ Induction-hardened precision cutting edges, hardness 61-63 HRC
- ✔ GEDORE special hardened and tempered steel, drop-forged, oil-hardened and annealed
- ✔ JC = chrome-plated, 2-component handles

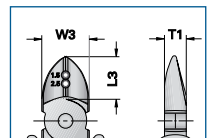

Code	No.	L	L ₃	W ₃	T ₁	Cable cross section	Ø	↕	☑
1396722	8315-160 JC	160	19	22	10	1,5 / 2,5	1,6	235	1



8316 Power side cutter

Maximum cutting performance yet with a low level of effort expended thanks to an optimum interaction of cutting geometry, eccentric rivet bearing and ergonomic handle design.



Gripping surface with file-cut for a particularly effective hold

Inductively hardened cutting edges (63-65 HRC) ensure constant cutting power over a long time span



Power pliers: The effort required in using them is down 35% on account of the pivot transferred to the front and the resulting lengthened lever.



High-grade 2-component handles with finger protection enable work to be done ergonomically and to the exclusion of tiredness



8316

POWER SIDE CUTTER American pattern

- Acc. to DIN ISO 5749
- Good lever action for easy cutting
- Induction-hardened precision cutting edges, hardness 63-65 HRC
- To cut all wire types including piano wire
- Max. cutting capacity \varnothing 1,4-2,0 mm
- GEDORE special hardened and tempered steel, drop-forged, oil-hardened and annealed
- JC = chrome-plated, 2-component handles
- TL = black, with blue dipped handle protectors



JC



TL

Code	No.	L	L ₂	W ₂	T ₁	\varnothing	\pm	\pm
6744190	8316-140 JC	140	17.0	22.0	9.5	1,4	175	5
6711930	8316-140 TL	140	17.0	22.0	9.5	1,4	146	5
6744510	8316-160 JC	160	19.0	24.5	10.0	1,6	236	5
6712070	8316-160 TL	160	19.0	24.5	10.0	1,6	195	5
1439588	8316-180 JC	180	22.6	26.0	11.0	1,8	265	5
1439596	8316-180 TL	180	22.6	26.0	11.0	1,8	225	5
6745080	8316-200 JC	200	22.0	28.0	11.0	2,0	340	5
6712150	8316-200 TL	200	22.0	28.0	11.0	2,0	270	5

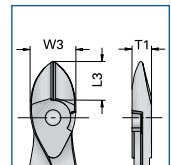

8318

LEVER-ACTION SIDE CUTTER

- For hard wire
- Double-jointed for maximum cutting performance
- Head and joint made from special steel, head gun-metal finished
- Handles chrome-plated and PVC coated



Code	No.	\varnothing	\pm mm	\pm inch	\pm	\pm
6745590	8318-160 TL	1,6	160	6.1/2	213	1

8330

LEVER-ACTION SIDE CUTTER

- Acc. to DIN ISO 5749
- For hard wire
- Double-lever mechanism for maximum cutting performance
- C65 tool steel, fully forged
- Blue hammer-enamel finish
- * not standardised

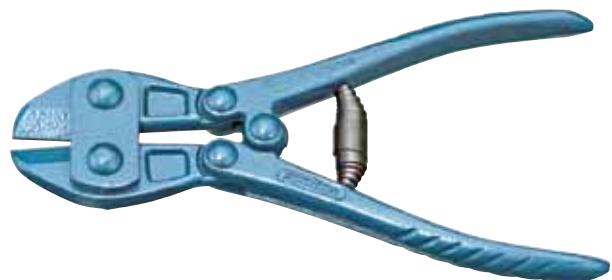

Code	No.	*	\varnothing	\pm mm	\pm inch	\pm	\pm
6747370	8330-180	*	2,5	198	7	501	1
6747450	8330-225		2,5	225	8.3/4	558	1



8370

LEVER-ACTION END CUTTING NIPPER

- ▶ Acc. to DIN ISO 5748
- ▶ For hard wire
- ▶ Double-lever mechanism for maximum cutting performance
- ▶ C65 tool steel, fully forged
- ▶ Blue hammer-enamel finish
- ▶ * not standardised

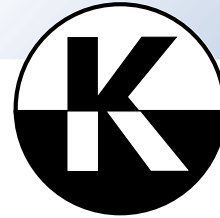

311

Code	No.	*	∅	↳mm↳	↳inch↳	↕	📦
6750830	8370-180		2	180	7	501	1
6751050	8370-210		2	210	8.1/2	558	1
6751210	8370-235	*	2,5	235	9.1/4	586	1

8367

END NIPPER POWER

- ▶ Acc. to DIN ISO 5748
- ▶ Good lever action for easy cutting
- ▶ Induction-hardened precision cutting edges, hardness 63-65 HRC
- ▶ To cut all wire types including piano wire
- ▶ GEDORE special hardened and tempered steel, drop-forged, oil-hardened and annealed
- ▶ JC = chrome-plated, 2-component handles with secure-grip hand protection
- ▶ TL = black, with blue dipped handle protectors

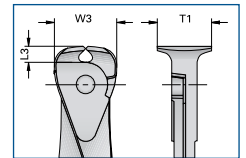

Code	No.	L	L ₃	W ₃	T ₁	∅	↕	📦
6749150	8367-160 JC	160	6.9	27	23.5	1,6	254	5
6712230	8367-160 TL	160	6.9	27	23.5	1,6	242	5

8380

TOWER PINCER

- ▶ Heavy-duty wire braid and mesh-cutting pincers
- ▶ Acc. to DIN ISO 9242, Form A
- ▶ Induction-hardened precision cutting edges, hardness 61-63 HRC
- ▶ Heads ground, black with blue dipped handle protectors (TL)
- ▶ Geometrically optimised head and handle areas for ergonomic use
- ▶ In high-quality tool steel

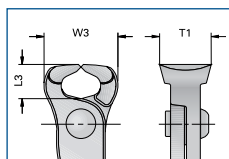

Code	No.	L	L ₃	W ₃	T ₁	↕	📦
6752020	8380-225 TL	225	16	31	22	358	1
6752100	8380-250 TL	250	16	35	25	423	1
6752290	8380-280 TL	280	16	35	25	541	1

8381

PINCER

- ▶ Standard heavy-duty pincers
- ▶ Acc. to DIN ISO 9243, Form A
- ▶ Induction-hardened precision cutting edges, hardness 61-63 HRC
- ▶ Heads ground, black with blue dipped handle protectors (TL)
- ▶ In high-quality tool steel

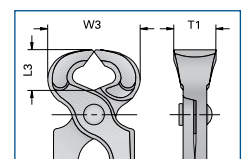

Code	No.	L	L ₃	W ₃	T ₁	↕	📦
6752370	8381-160 TL	160	21.0	48	20	258	1
6751800	8381-180 TL	180	21.0	50	23	362	1
6751990	8381-200 TL	200	23.5	55	26	442	1
6752450	8381-225 TL	225	23.5	55	25	514	1
6752530	8381-250 TL	250	23.5	58	27	586	1



FLAT NOSE / ROUND NOSE PLIERS

8110

FLAT NOSE PLIERS without wire cutter, serrated

- ▶ Acc. to DIN ISO 5745
- ▶ Short jaws, serrated gripping faces
- ▶ For holding and bending
- ▶ GEDORE special hardened and tempered steel, drop-forged, oil-hardened and annealed
- ▶ JC = chrome-plated, 2-component handles
- ▶ TL = black, with blue dipped handle protectors



Code	No.	L	L ₃	W ₃	W ₄	T ₁		
6711690	8110-140 JC	140	28.5	16.5	3.6	8.5	154	1
6711500	8110-140 TL	140	28.5	16.5	3.6	8.5	118	1

8112

ROUND NOSE PLIERS serrated

- ▶ Similar to DIN ISO 5745
- ▶ Short jaws, serrated gripping faces
- ▶ For gripping and bending
- ▶ GEDORE special hardened and tempered steel, drop-forged, oil-hardened and annealed
- ▶ JC = chrome-plated, 2-component handles
- ▶ TL = black, with blue dipped handle protectors



Code	No.	L	L ₃	W ₃	D ₁	T ₁		
6713390	8112-140 JC	140	29.0	17.0	2.5	8.5	146	1
6713200	8112-140 TL	140	28.5	16.5	2.5	8.5	110	1

8120

FLAT NOSE PLIERS without wire cutter, serrated

- ▶ Acc. to DIN ISO 5745
- ▶ Long jaws, serrated gripping faces
- ▶ For holding and bending
- ▶ GEDORE special hardened and tempered steel, drop-forged, oil-hardened and annealed
- ▶ JC = chrome-plated, 2-component handles
- ▶ TL = black, with blue dipped handle protectors



Code	No.	L	L ₃	W ₃	W ₄	T ₁		
6715170	8120-160 JC	160	51	16.5	3.4	9	170	5
6710370	8120-160 TL	160	51	16.5	3.4	9	133	5

8122

ROUND NOSE PLIERS serrated

- ▶ Acc. to DIN ISO 5745
- ▶ Long jaws, serrated gripping faces
- ▶ For gripping and bending
- ▶ GEDORE special hardened and tempered steel, drop-forged, oil-hardened and annealed
- ▶ JC = chrome-plated, 2-component handles
- ▶ TL = black, with blue dipped handle protectors



Code	No.	L	L ₃	W ₃	D ₁	T ₁		
6716490	8122-140 JC	140	40	15.5	2.3	8.2	130	1
6710450	8122-140 TL	140	40	15.5	2.3	8.2	110	1
6716810	8122-160 JC	160	48	16.5	2.5	8.7	150	5
6710530	8122-160 TL	160	48	16.5	2.5	8.7	114	5



8132

NEEDLE NOSE PLIERS with wire cutter, serrated, straight pattern

- ▶ Acc. to DIN ISO 5745
- ▶ Flat-round jaws, straight gripping faces, serrated
- ▶ For holding, gripping, bending and cutting
- ▶ Induction-hardened precision cutting edges, hardness 61-63 HRC
- ▶ GEDORE special hardened and tempered steel, drop-forged, oil-hardened and annealed
- ▶ JC = chrome-plated, 2-component handles
- ▶ TL = black, with blue dipped handle protectors

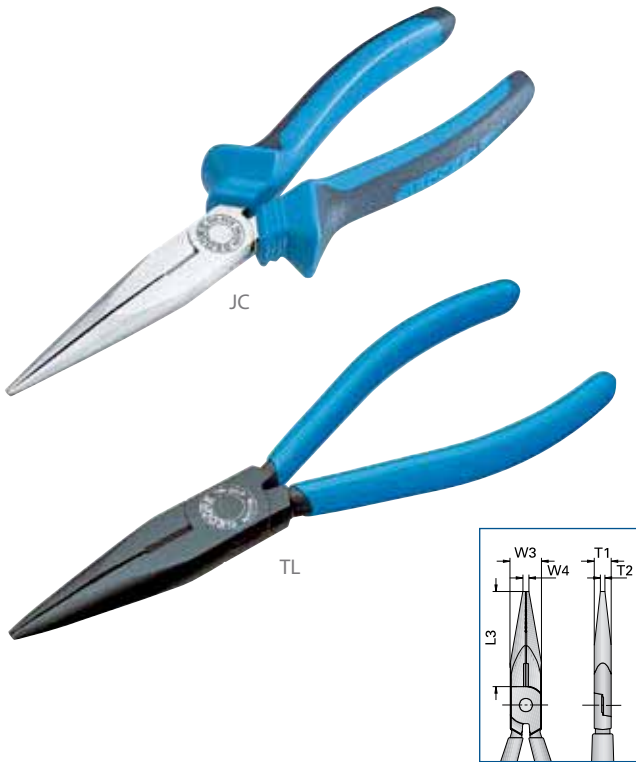

Code	No.	L	L ₂	W ₃	W ₄	T ₁	T ₂	↔	☒
6718860	8132-140 JC	140	42.0	15.0	2.5	7.8	2.0	125	5
6710610	8132-140 TL	140	42.0	15.0	2.5	7.8	2.0	104	5
6719240	8132-160 JC	160	50.0	16.5	3.2	9.0	2.5	166	5
6710880	8132-160 TL	160	50.0	16.5	3.2	9.0	2.5	129	5
6719670	8132-200 JC	200	75.7	18.5	3.7	9.5	2.8	225	5
6710960	8132-200 TL	200	75.7	18.5	3.7	9.5	2.8	186	5

8132 AB

NEEDLE NOSE PLIERS with wire cutter, serrated, angled pattern

- ▶ Similar to DIN ISO 5745
- ▶ Flat-round jaws, angled gripping faces, serrated
- ▶ 45° angled tips make gripping round the corner possible
- ▶ Induction-hardened precision cutting edges, hardness 61-63 HRC
- ▶ GEDORE special hardened and tempered steel, drop-forged, oil-hardened and annealed
- ▶ JC = chrome-plated, 2-component handles
- ▶ TL = black, with blue dipped handle protectors

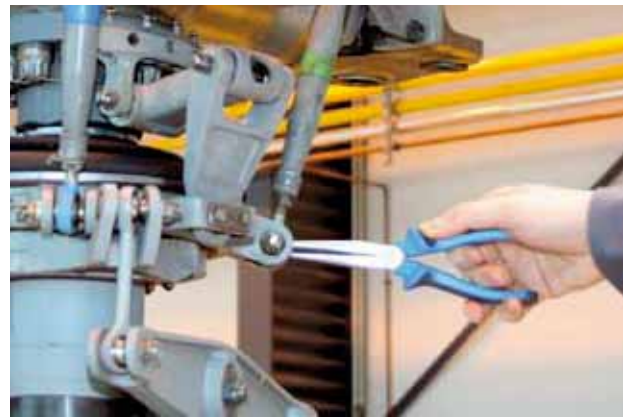
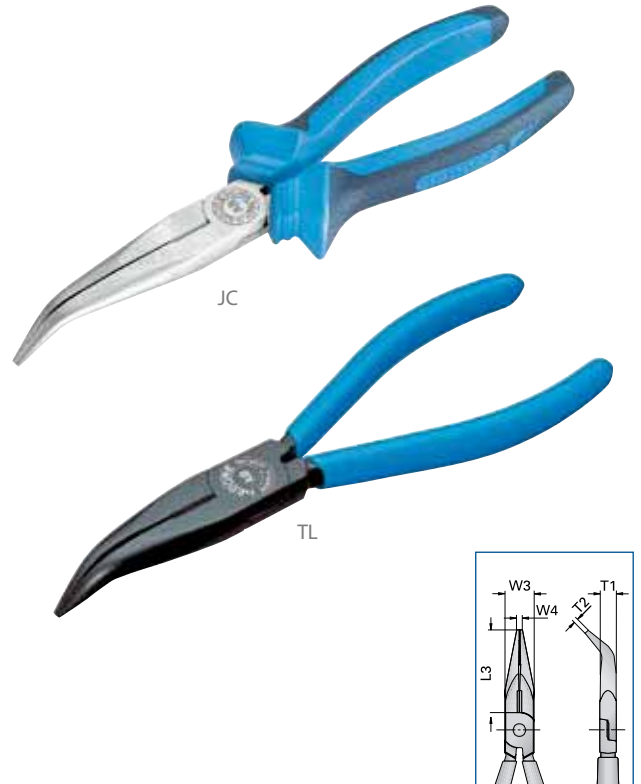

Code	No.	L	L ₂	W ₃	W ₄	T ₁	T ₂	↔	☒
6720920	8132 AB-160 JC	160	46.0	16.5	3.2	9.0	2.5	163	5
6711180	8132 AB-160 TL	160	46.0	16.5	3.2	9.0	2.5	125	5
6721300	8132 AB-200 JC	200	70.5	18.5	3.7	9.5	2.8	225	5
6711260	8132 AB-200 TL	200	70.5	18.5	3.7	9.5	2.8	190	5

1500 ES



87

S 8003 JC



352

1500 CT



92



i 8133 Multiple pliers



8133

MULTIPLE PLIERS with cutting edge, serrated, straight pattern

- ▶ Multifunctional pliers for the mechanical and electronic fields
- ▶ Holding, cutting, insulation-stripping, crimping, squeezing
- ▶ Flat-round jaws, straight gripping faces, serrated
- ▶ Induction-hardened precision cutting edges, hardness 62-64 HRC
- ▶ GEDORE special hardened and tempered steel, drop-forged, oil-hardened and annealed
- ▶ JC = chrome-plated, 2-component handles
- ▶ TL = clear varnished, with blue dipped handle protectors



Code	No.	mm	mm	mm
6722110	8133-180 JC	180	180	5
1997394	8133-180 TL	180	160	5

8135

TELEPHONE PLIERS without wire cutter, serrated, straight pattern

- ▶ Acc. to DIN ISO 5745, straight pattern
- ▶ Flat-round tapered jaws, cross-hatched gripping surfaces and fine-tipped nose
- ▶ Also suitable as needle nose soldering pliers
- ▶ GEDORE special hardened and tempered steel, drop-forged, oil-hardened and annealed
- ▶ JC = chrome-plated, 2-component handles
- ▶ TL = black, with blue dipped handle protectors

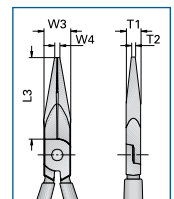
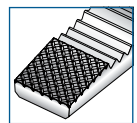

Code	No.	L	L ₃	W ₃	W ₄	T ₁	T ₂	mm	mm
6722380	8135-140 JC	140	42	15.0	2.5	7.8	2.0	131	1
6722460	8135-140 TL	140	42	15.0	2.5	7.8	2.0	108	1
6722540	8135-160 JC	160	50	16.5	3.2	9.0	2.5	166	1
6722620	8135-160 TL	160	50	16.5	3.2	9.0	2.5	142	1



MECHANICS PLIERS

8136

MECHANICS PLIERS without wire cutter, straight pattern

- Acc. to DIN ISO 5745
- Flat-round tapered jaws, cross-hatched gripping surfaces
- For holding, gripping and bending
- Fine-tipped nose, for safe work in confined spaces
- GEDORE special hardened and tempered steel, drop-forged, oil-hardened and annealed
- JC = chrome-plated, 2-component handles
- TL = black, with blue dipped handle protectors



Code	No.	L	L ₃	W ₃	W ₄	T ₁	T ₂	↔	☒
6722700	8136-200 JC	200	75.7	18.5	3.7	9.5	2.8	241	1
6722890	8136-200 TL	200	75.7	18.5	3.7	9.5	2.8	201	1

8137

MECHANICS PLIERS without wire cutter, offset pattern

- Flat-round tapered jaws, cross-hatched gripping surfaces
- Fine-tipped nose
- Gently-curved jaws enable holding and gripping to be done in inaccessible places
- GEDORE special hardened and tempered steel, drop-forged, oil-hardened and annealed
- JC = chrome-plated, 2-component handles
- TL = black, with blue dipped handle protectors

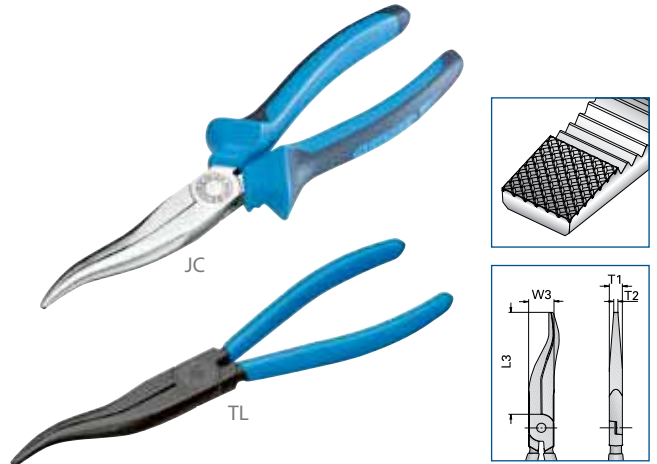

Code	No.	L	L ₃	W ₃	T ₁	T ₂	↔	☒
6723190	8137-200 JC	200	74	18.5	9.5	2.8	231	1
6723270	8137-200 TL	200	74	18.5	9.5	2.8	200	1

8136 AB

MECHANICS PLIERS without wire cutter, angled pattern

- Similar to DIN ISO 5745
- Flat-round tapered jaws, cross-hatched gripping surfaces
- 45° angled tips make gripping round the corner possible
- Fine-tipped nose, for safe work in confined spaces
- GEDORE special hardened and tempered steel, drop-forged, oil-hardened and annealed
- JC = chrome-plated, 2-component handles
- TL = black, with blue dipped handle protectors

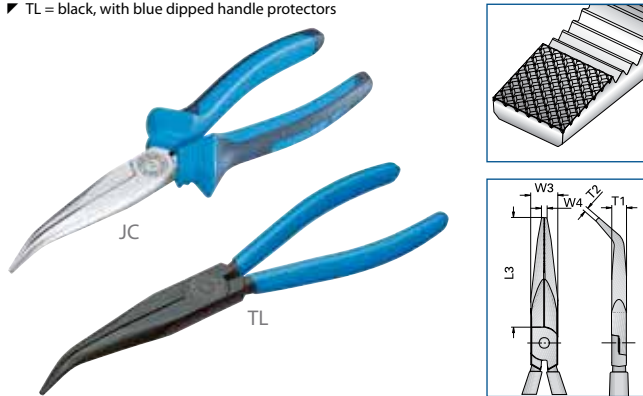

Code	No.	L	L ₃	W ₃	W ₄	T ₁	T ₂	↔	☒
6722970	8136 AB-200 JC	200	70	18.5	3.7	9.5	2.8	239	1
6723000	8136 AB-200 TL	200	70	18.5	3.7	9.5	2.8	201	1

8138

MECHANICS PLIERS without wire cutter, 30° angled

- 30° angled flat-round tapered, hooked jaws, cross-hatched gripping surfaces 30°, fine-tipped nose
- For safe gripping, positioning and loosening of round, oval and angular parts
- Ideal for spark plug connectors
- GEDORE special hardened and tempered steel, drop-forged, oil-hardened and annealed
- JC = chrome-plated, 2-component handles
- TL = black, with blue dipped handle protectors



Code	No.	L	L ₃	W ₃	T ₁	T ₂	↔	☒
6723350	8138-200 JC	200	68	18.5	9.5	2.8	234	1
6723430	8138-200 TL	200	68	18.5	9.5	2.8	200	1

ON APPLICATION



8385



348



CABLE CUTTER



8317 Bowden cable cutter



Crimping of Bowden cable sleeves and end sleeves 1.5 mm and 2 mm

Opening springs as relief for one's hands

Cutting edge additionally inductively hardened, precise cut thanks to the novel GEDORE cutting form

Transport lock

For cutting Bowden cables and steel cables up to 2 mm in diameter and Bowden cable sleeves up to 5 mm

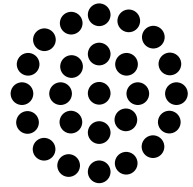

8317

BOWDEN CABLE CUTTER

- For cutting wire rope up to 2 mm diameter and bowden-cable sleeves up to 5 mm diameter
- Crimping of bowden-cable sleeves and end-sleeves 1.5 mm and 2 mm
- For medium hard wire
- With opening spring, transport lock and width adjustment
- Induction-hardened cutting edges
- Innovative GEDORE cutting form produces a precision cut
- Low overall weight



Code	No.	mm	mm	mm
2011638	8317-160 JC	170	150	1

8095

CABLE SHEARS

- Shear's head in stainless steel, opens automatically
- With impact-resistant plastic handles
- With practical closure
- For wire up to 10 mm²

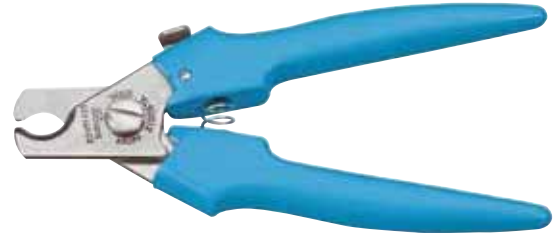

Code	No.	Cable cross section	mm	inch	mm	mm
6707820	8095-160	10	160	6.1/2	134	1

CABLE SHEARS

8093

CABLE SHEARS

- For cutting multi-strand copper and aluminium cables up to Ø 27 mm
- Not suitable for wire ropes and steel wire
- New cutting-edge geometry for a clean, smooth cut
- Optimum lever action requires less effort
- Compact design, low weight
- Cutter head made from forged special tool steel
- High-strength tubular aluminium handles, powder-enamelled, with rubber grips



Code	No.	Ø	Cable cross section	mm	inch	mm	mm
6724830	8093	27	150	505	20	1056	1

8094

CABLE SHEARS

- For cutting multi-strand copper and aluminium cables up to Ø 20 mm, and up to Ø 25 mm with first and second cut
- Cutting edges additionally inductively hardened,
- Precision ground for optimum action, new cutting-edge geometry
- Adjustable screw joint with finger protection
- Not suitable for steel wire or hard-drawn copper wire
- Special hardened and tempered steel, forged, gun-metal finish, with dipped handle grips



Code	No.	Ø	Cable cross section	mm	inch	mm	mm
6724910	8094	20	70	200	8.1/2	329	1

STRIPPING PLIERS

8097

STRIPPING PLIERS automatic

- ✔ With V-shaped cutting knife
- ✔ For stripping single-strand conductors 0.2 - 6.0 mm²
- ✔ Adjustable stripping length
- ✔ With wire cutter up to 2 mm



Code	No.	mm	Inch	Cable cross section	mm	mm
6702940	8097	200	8	0,2-6	193	1

8099

STRIPPING PLIERS STRIP-FIX

- ✔ Self-adjusting, for wires 0.5-5.0 mm²
- ✔ V-shaped cutting jaws for stripping the plastic insulation of single and multi-strand conductors
- ✔ GEDORE special hardened and tempered steel, drop-forged, oil-hardened and annealed
- ✔ JCP = chrome-plated, with 2-component handle protectors



Code	No.	mm	Inch	Cable cross section	mm	mm
6709520	8099-160 JCP	160	6.1/2	0,5-5	217	1

8098

STRIPPING PLIERS

- ✔ Opens automatically, with spring and locking screw
- ✔ V-shaped cutting jaws for stripping the plastic insulation of single and multi-strand conductors
- ✔ Adjuster and counter screws for easy setting to the desired wire or flex diameter
- ✔ For 0.8-6.0 mm wires²
- ✔ GEDORE special hardened and tempered steel, drop-forged, oil-hardened and annealed
- ✔ JC = chrome-plated, 2-component handles with secure-grip hand protection
- ✔ TL = clear varnished, with blue dipped handle protectors

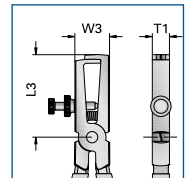

Code	No.	L	L ₂	W ₃	T ₁	Cable cross section	mm	mm
6708630	8098-160 JC	160	43.5	18.5	8.5	0,8-6	198	5
6710020	8098-160 TL	160	43.5	18.5	8.5	0,8-6	153	5

177



349

8146 · 8148



333



ELECTRONIC PLIERS

Electronic Pliers

- For bending, straightening and assembly work in the electronic and precision mechanical sector
- GEDORE-ESD-electronic-pliers dissipate electrostatic energy in a slow, controlled manner
- Surfaces: Ground-steel - no flaking chrome parts to cause faults in electronic circuitry

Precision box joint, induction-hardened cutting edges

2-component handles with thermoplastic inserts, slip-inhibiting comfort grip

Precision-polished faces

Welded-in double leaf spring cannot be lost, ensuring perfect functioning and a long service life



ESD = ELECTROSTATIC DISCHARGE PROTECTION
BL [JL] = JAW LENGTH
SL [CL] = CUTTING EDGE LENGTH



Attention! Safety Note!

Due to the conductivity of the ESD 2-component handles, these tools must not be brought into contact with live conductors passing a voltage sufficient to cause an electric shock.



Care regulation



- For safety reasons ESD pliers are not coated with chrome.
- The surface of the pliers is of polished steel and therefore is at the mercy of corrosion.
- As such, the surfaces of these pliers must be cleaned with a cloth at least 1x a day either during or after the work.
- We would recommend our 8305 MT microfibre cloth

ELECTRONIC PLIERS SET

S 8305 ESD

ELECTRONIC PLIERS SET 6 pieces

- In artificial leather wallet
- Dimensions: L 230 x W 165 x H 55 mm
- With microfibre cloth 8305 MT



Code	No.	Contents	STP
1955551	S 8305 ESD	8305-9 8306-1 8306-6 8307-2 8307-3 8308-1 8305 MT	680
1969536	8305 MT		12



ELECTRONIC SIDE CUTTERS

Induction-hardened precision cutting edges, 61-63 HRC

8306-1

ELECTRONIC SIDE CUTTER

- ▶ Oval head, with bevel
- ▶ Induction-hardened precision cutting edges, 61-63 HRC
- ▶ Cutting values:
- ▶ Hard wire: 0.4 mm/AWG 26
- ▶ Soft steel: 1.0 mm/AWG 18
- ▶ Copper wire: 1.5 mm/AWG 15
- ▶ ESD = electrostatic discharge protection

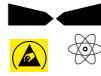

Code	No.	CL	↳mm↳	↕	📦
6726450	8306-1	12	125	80	1

8306-2

MINIATURE ELECTRONIC SIDE CUTTER

- ▶ Short, oval head, with fine bevel
- ▶ Induction-hardened precision cutting edges, 61-63 HRC
- ▶ Cutting values:
- ▶ Soft steel: 0.6 mm/AWG 22
- ▶ Copper wire: 1.2 mm/AWG 16
- ▶ ESD = electrostatic discharge protection

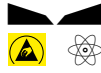

Code	No.	CL	↳mm↳	↕	📦
6726530	8306-2	9	120	71	1

8306-4

ELECTRONIC SIDE CUTTER

- ▶ Oval head, with fine bevel
- ▶ Induction-hardened precision cutting edges, 61-63 HRC
- ▶ Cutting values:
- ▶ Soft steel: 1.0 mm/AWG 18
- ▶ Copper wire: 1.5 mm/AWG 15
- ▶ ESD = electrostatic discharge protection



Code	No.	CL	↳mm↳	↕	📦
6727180	8306-4	14	125	81	1

8306-5

MINIATURE ELECTRONIC SIDE CUTTER

- ▶ Pointed head, with fine bevel
- ▶ Induction-hardened precision cutting edges, 61-63 HRC
- ▶ Cutting values:
- ▶ Hard wire: 0.4 mm/AWG 26
- ▶ Soft steel: 1.0 mm/AWG 18
- ▶ Copper wire: 1.2 mm/AWG 16
- ▶ ESD = electrostatic discharge protection

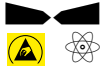

Code	No.	CL	↳mm↳	↕	📦
6727340	8306-5	12	125	79	1

8306-6

MINIATURE ELECTRONIC SIDE CUTTER

- ▶ Short, head pointed and flattened (relief-milled), with fine bevel
- ▶ Induction-hardened precision cutting edges, 61-63 HRC
- ▶ Cutting values:
- ▶ Soft steel: 0.6 mm/AWG 22
- ▶ Copper wire: 1.0 mm/AWG 18
- ▶ ESD = electrostatic discharge protection



Code	No.	CL	↳mm↳	↕	📦
6727500	8306-6	10	120	72	1

8306-8

MINIATURE ELECTRONIC SIDE CUTTER

- ▶ With wire gripper
- ▶ Oval head, with bevel
- ▶ Induction-hardened precision cutting edges, 61-63 HRC
- ▶ Cutting values:
- ▶ Hard wire: 0.4 mm/AWG 26
- ▶ Soft steel: 1.0 mm/AWG 18
- ▶ Copper wire: 1.5 mm/AWG 15
- ▶ ESD = electrostatic discharge protection

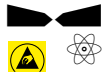

Code	No.	CL	↳mm↳	↕	📦
6727930	8306-8	13	125	76	1



ELECTRONIC SIDE CUTTER CARBIDE

- ▶ Tungsten-carbide cutting edges induction-hardened, 84-86 HRA

8306-7

ELECTRONIC SIDE CUTTER CARBIDE

- ▶ Oval head, with bevel
- ▶ Tungsten-carbide cutting edges for an extremely long service life
- ▶ Hardness 84-86 HRA
- ▶ Cutting values:
- ▶ Piano wire: 0.6 mm/AWG 22
- ▶ Hard steel: 1.0 mm/AWG 18
- ▶ Nickel wire: 1.2 mm/AWG 16
- ▶ ESD = electrostatic discharge protection

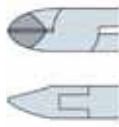
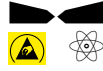

Code	No.	CL	(mm)		
6727770	8306-7	11	125	76	1

8306-9

ELECTRONIC SIDE CUTTER CARBIDE

- ▶ Tungsten-carbide cutting edges for an extremely long service life
- ▶ Hardness 84-86 HRA
- ▶ Pointed, slim head for work in confined spaces
- ▶ Without bevel
- ▶ Cutting values:
- ▶ Piano wire: 0.3 mm
- ▶ Hard steel: 0.5 mm
- ▶ Nickel wire: 0.6 mm
- ▶ Especially for cutting SMD components
- ▶ With opening spring
- ▶ ESD = electrostatic discharge protection

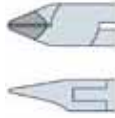
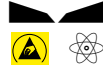

Code	No.	CL	(mm)		
1743414	8306-9	11	125	76	1

8306-10

ELECTRONIC SIDE CUTTER CARBIDE

- ▶ Oval head, with special bevel, especially suitable for cutting glass fibre and Kevlar®
- ▶ Tungsten-carbide cutting edges for an extremely long service life
- ▶ Hardness 84-86 HRA
- ▶ With opening spring
- ▶ ESD = electrostatic discharge protection
- ▶ Kevlar® is a registered trademark of the company DuPont

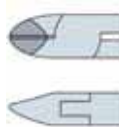

Code	No.	CL	(mm)		
1743422	8306-10	11	125	77	1

ELECTRONIC DIAGONAL CUTTERS AND END NIPPERS

8308-1

ELECTRONIC MINI DIAGONAL CUTTER

- ▶ Pointed head, cutting edges angled 55°, with fine bevel
- ▶ For working in confined spaces
- ▶ Induction-hardened precision cutting edges, hardness 61-63 HRC
- ▶ Cutting values:
- ▶ Hard steel: 0.4 mm/AWG 26
- ▶ Soft steel: 1.0 mm/AWG 18
- ▶ Copper wire: 1.2 mm/AWG 16
- ▶ With opening spring
- ▶ ESD = electrostatic discharge protection

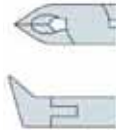
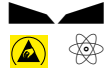

Code	No.	CL	(mm)		
1743600	8308-1	12	125	76	1

8308-3

ELECTRONIC DIAGONAL CUTTER

- ▶ Wide head and long cutting faces, with fine bevel
- ▶ Cutting edges angled 55°
- ▶ Head ground to a point on one side
- ▶ For working in confined spaces
- ▶ Induction-hardened precision cutting edges, hardness 61-63 HRC
- ▶ Cutting values:
- ▶ Hard steel: 0.4 mm/AWG 26
- ▶ Soft steel: 1.0 mm/AWG 18
- ▶ Copper wire: 1.5 mm/AWG 15
- ▶ With opening spring
- ▶ ESD = electrostatic discharge protection



Code	No.	CL	(mm)		
1743627	8308-3	15	135	94	1

8308-4

ELECTRONIC END CUTTING NIPPERS

- ▶ Wide head and long cutting faces, with fine bevel
- ▶ High cutting performance
- ▶ Induction-hardened precision cutting edges, hardness 61-63 HRC
- ▶ Cutting values:
- ▶ Hard steel: 0.4 mm/AWG 26
- ▶ Soft steel: 1.0 mm/AWG 18
- ▶ Copper wire: 1.5 mm/AWG 15
- ▶ With opening spring
- ▶ ESD = electrostatic discharge protection



Code	No.	CL	(mm)		
1743635	8308-4	15	135	98	1



NEEDLE NOSE ELECTRONIC PLIERS

8305-2

NEEDLE NOSE ELECTRONIC PLIERS

- ▶ Extra long, half-round jaws, with file-cut surface
- ▶ ESD = electrostatic discharge protection



Code	No.	JL	mm	mm	mm
6725480	8305-2	39	165	111	1



8305-6

FINE NEEDLE NOSE ELECTRONIC PLIERS

- ▶ Extra slim jaws and fine point
- ▶ Without file-cut
- ▶ ESD = electrostatic discharge protection



Code	No.	JL	mm	mm	mm
6725720	8305-6	40	160	101	1

NEEDLE NOSE ELECTRONIC PLIERS 45° ANGLED

8307-3

NEEDLE NOSE ELECTRONIC PLIERS

- ▶ Slim, narrow, flat-round tapered jaws, angled 45°
- ▶ Gripping faces with fine file cut
- ▶ With opening spring
- ▶ ESD = electrostatic discharge protection



Code	No.	JL	mm	mm	mm
1743554	8307-3	22	140	81	1

8307-4

NEEDLE NOSE ELECTRONIC PLIERS

- ▶ Slim, narrow, flat-round tapered jaws
- ▶ Smooth-ground gripping faces
- ▶ With opening spring
- ▶ ESD = electrostatic discharge protection



Code	No.	JL	mm	mm	mm
1743562	8307-4	31	145	74	1

8307-7

LONG NOSE ELECTRONIC PLIERS

- ▶ Extra long, flat-round tapered jaws, angled 45°
- ▶ For bending and straightening jobs
- ▶ Smooth-ground gripping faces
- ▶ With opening spring
- ▶ ESD = electrostatic discharge protection

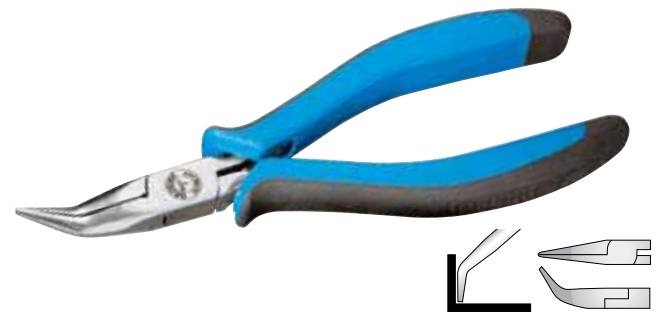

Code	No.	JL	mm	mm	mm
1743597	8307-7	35	165	113	1

8305-4

NEEDLE NOSE ELECTRONIC PLIERS

- ▶ Long, half-round jaws, with file-cut surface
- ▶ Extra fine needle nose: 1 x 1.5 mm
- ▶ ESD = electrostatic discharge protection



Code	No.	JL	mm	mm	mm
6725560	8305-4	23	135	79	1





SPECIAL ELECTRONIC PLIERS

8305-5

ELECTRONIC END CUTTING NIPPERS

- Long, slim head
- Induction-hardened precision cutting edges, with fine bevel
- Cutting values:
Soft steel: 0.6 mm/AWG 22
Copper wire: 0.8 mm/AWG 20
- ESD = electrostatic discharge protection

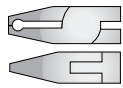

Code	No.	CL	mm	mm	mm	mm
6725640	8305-5	2	130	75	1	

8308-6

ROUND NOSE ELECTRONIC PLIERS

- Oval head, with bevel and opening spring
- For delicate work in the electronic sector, suitable for Kevlar®
- Long service life
- Tips tapering to Ø 1 mm, without file-cut
- ESD = electrostatic discharge protection
- Kevlar® is a registered trademark of the company DuPont

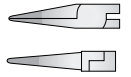

Code	No.	JL	mm	mm	mm	mm
1743651	8308-6	20	135	78	1	

8305-7

ELECTRONIC DIAGONAL CUTTER

- 30° angle cutting edges, with fine bevel
- With slim head for confined spaces
- Cutting values:
Soft steel: 0.6 mm/AWG 22
Copper wire: 0.8 mm/AWG 20
- ESD = electrostatic discharge protection

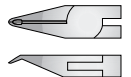
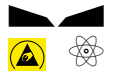

Code	No.	CL	mm	mm	mm	mm
6725990	8305-7	6	135	73	1	



8305-9

FLAT NOSE ELECTRONIC PLIERS

- Straight pattern
- Without file-cut
- ESD = electrostatic discharge protection

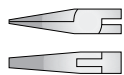

Code	No.	JL	mm	mm	mm	mm
6726370	8305-9	23	135	73	1	

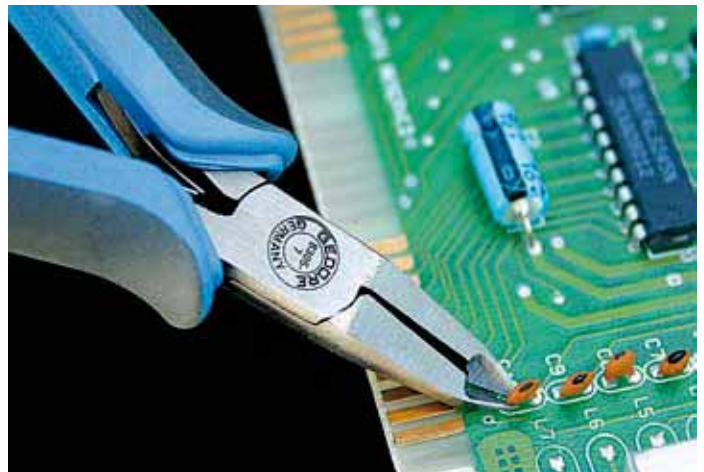

VDE 8132 AB



510



MINIATURE ELECTRONIC PLIERS

- ▶ Made from high-performance hardened and tempered steel, handles hardened and tempered
- ▶ Induction-rehardened cutting edges, 59-61 HRC, faces phosphated
- ▶ With opening spring
- ▶ 2-component handles with secure-grip hand protection

8350-2

MINIATURE ELECTRONIC SIDE CUTTER

- ▶ Sharp, narrow needle-point head
- ▶ Cutting edges angled 21°, without bevel
- ▶ Cutting values:
Copper wire: max. 0.8 mm / AWG 20

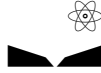

Code	No.	CL	l-mm	l-cm	l-in
1828967	8350-2	8	138	73	5

8350-3

MINIATURE ELECTRONIC SIDE CUTTER

- ▶ Sharp, narrow needle-point head
- ▶ With wire-grip clamp
- ▶ Cutting edges angled 21°, without bevel
- ▶ Cutting values:
Copper wire: max. 1.0 mm / AWG 18

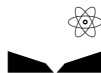

Code	No.	CL	l-mm	l-cm	l-in
1828975	8350-3	8	138	82	5

8350-5

MINIATURE ELECTRONIC DIAGONAL END CUTTING NIPPERS

- ▶ Wide, needle-point head
- ▶ Cutting edges angled 48°, without bevel
- ▶ Cutting values:
Copper wire: max. 1.3 mm / AWG 16

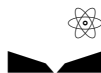

Code	No.	CL	l-mm	l-cm	l-in
1828991	8350-5	8	136	85	5

8350-6

MINIATURE ELECTRONIC SIDE CUTTER

- ▶ Wide, needle-point head
- ▶ Cutting edges angled 21°, without bevel
- ▶ Cutting values:
Copper wire: max. 1.3 mm / AWG 16
Medium-hard wire: max. 1.0 mm / AWG 18

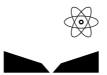

Code	No.	CL	l-mm	l-cm	l-in
1829009	8350-6	8	138	94	5

8350-7

MINIATURE ELECTRONIC SIDE CUTTER

- ▶ Wide, needle-point head
- ▶ Cutting edges angled 21°, without bevel
- ▶ Cutting values:
Copper wire: max. 1.3 mm / AWG 16

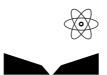

Code	No.	CL	l-mm	l-cm	l-in
1829017	8350-7	8	138	86	5

8350-8

MINIATURE ELECTRONIC SIDE CUTTER Power Line

- ▶ Tungsten-carbide technology for heavy continuous use
- ▶ Fabric insert for increased strength
- ▶ Wide, needle-point head
- ▶ Cutting edges angled 21°, small bevel
- ▶ Cutting values:
Copper wire: max. 2.0 mm / AWG 12
Medium-hard wire: max. 1.6 mm / AWG 14

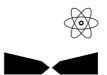

Code	No.	CL	l-mm	l-cm	l-in
1829025	8350-8	12	140	110	5



**8350-9****MINIATURE ELECTRONIC SIDE CUTTER**

- Wide, needle-point head
- With wire-grip spring
- Cutting edges angled 21°, without bevel
- Cutting values:
Copper wire: max. 1.3 mm / AWG 16
Medium-hard wire: max. 1.0 mm / AWG 18



Code	No.	CL	mm	mm	mm	mm
1829033	8350-9	10	138	94	5	

8352-2**MINIATURE ELECTRONIC FLAT NOSE PLIERS**

- Long, narrow, smooth jaws



Code	No.	JL	mm	mm	mm	mm
1829076	8352-2	32	158	94	5	

8351-1**MINIATURE ELECTRONIC SIDE CUTTER Power Line**

- Tungsten-carbide technology for heavy continuous use
- Cutting edges angled 21°, slight bevel, hardness 62 HRC
- Cutting values:
Copper wire: max. 2.0 mm / AWG 12
Medium-hard wire: max. 1.6 mm / AWG 14
Piano wire: max. 0.6 mm / AWG 22



Code	No.	CL	mm	mm	mm	mm
1829041	8351-1	8	137	109	5	

8352-3**MINIATURE ELECTRONIC NEEDLE NOSE PLIERS**

- Long, narrow, serrated jaws
- Cutting edges angled 45°



Code	No.	JL	mm	mm	mm	mm
1829084	8352-3	35	152	92	5	

**8352-1****MINIATURE ELECTRONIC NEEDLE NOSE PLIERS**

- Short, narrow, smooth jaws
- Surface phosphated



Code	No.	JL	mm	mm	mm	mm
1829068	8352-1	20	145	90	5	

8353-1**MINIATURE ELECTRONIC WIRE STRIPPING PLIERS**

- Multipurpose tool for cutting, stripping and terminal crimping



Code	No.	JL	mm	Cable cross section	AWG	mm	mm
1829092	8353-1	40	175	0,25-08	30-20	126	5

8353-2

332

8353-3

332

VDE 4522

515

ACCESSORIES

8353-2

INSULATING VARNISH STRIPPER

- ✔ For removing insulating varnish
- ✔ Plastic handles
- ✔ Strips wires 0.6 mm² / AWG 22



Code	No.	↳mm↳	Cable cross section	AWG	↕	📦
1828924	8353-2	125	0,6	22	47	1

8354-1

DE-SOLDER TOOL

- ✔ With suction action for removing solder residues when de-soldering electronic components



Code	No.	↳mm↳	↕	📦
1828940	8354-1	220	96	1

4528

UNIVERSAL CABLE KNIFE

- ✔ For stripping round cables, 8-28 mm
- ✔ Hooked blade for separating cable strips and flat cables
- ✔ The cutting depth of the pivoting internal knife is adjustable
- ✔ 1 spare blade stored in handle



Code	No.	↔	↔	↕	📦
6698300	4528	50	170	80	5

4629

INSULATING TAPE



Code	No.	L m	mm	↕	📦
6699540	4629	10	15	32	1



8353-3

WIRE STRIPPING KNIFE

- ✔ For cable sizes 4-16 mm



Code	No.	Ø	↳mm↳	↕	📦
1828932	8353-3	4-16	140	87	1

STRIPPING TOOLS



137 ISOCUT

- ✔ Rotating precision blade
- ✔ Model that has proved itself in practice in the world of industry
- ✔ Screw for setting the cutting depth
- ✔ Toggle-lever locking for assured and guaranteed uniform cutting
- ✔ Suitable for various cable diameters

137 ISOCUT

STRIPPING PLIERS for power lines

- ✔ Pliers for stripping one or several insulation layers of buried cables and/or high voltage current lines up 42 mm in diameter
- ✔ The rotating quality knife makes elongated cuts possible
- ✔ The cables can be stripped over long sections using the elongated cut
- ✔ Blade length: 43 mm
- ✔ Cutting depth: 14 mm



Code	No.	↕	📦
1148826	137 ISOCUT	840	1

8147

HEAVY-DUTY CABLE STRIPPING TOOL

- ✔ Professional wire stripping tool with 2 cable hooks
- ✔ Compact and user-friendly, even in the most difficult conditions
- ✔ For cables (up to 40 mm Ø) with any kind of insulation
- ✔ Blade can be locked in one of three positions (circular, straight or spiral cuts)
- ✔ Cable capacity: 4.5-40 mm Ø
- ✔ Insulation thickness: up to 4.5 mm

Dimensions:

- ✔ with small cable hook: 150 x 42 x 30.5 mm
- ✔ with large cable hook: 167 x 52 x 30.5 mm
- ✔ E-8147 = Spare blade



Code	No.	Ø	↕	📦
1830856	8147	4,5-40	196	1
1884719	E-8147		2	1



8148

PRECISION STRIPPING TOOL for data cables

- User-friendly, easy to handle, all-round cut
- Precision adjustment of cutting depth (adjuster wheel with 9 positions)
- Replaceable blade
- Safe, rounded, pocket design
- Stripping capacity: 2.5-11 mm
- Insulation thickness: up to 1.0 mm
- Dimensions: 90.5 x 39.5 x 19 mm
- E-8148 = Spare blade

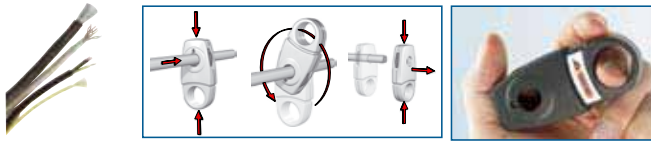

Code	No.	Ø	↔	📦
1830864	8148	2,5-11	43	1
1884727	E-8148		2	1



8146 Wire stripper

Advantages:

- Flexible: easy-change insert modules give this tool a wide stripping range
- Precision stripping: exact adjustment facility ensures accurate stripping - without any damage to the conductor
- Ergonomic and user-friendly: the soft main grip, easy-action operating lever, optimised span, angled head and low weight guarantee comfortable, user-friendly operation
- Reliable: tested through more than 150000 stripping processes



8149

STRIPPING TOOL for coaxial cables

- Individual blade adjustment guarantees a high level of stripping precision, all-round cut
- Supports a range of module inserts for two or three-step wire stripping, as well as V-blocks for different sizes
- User-friendly, ergonomic mechanism ensures a firm grip and easy operation
- Stripping capacity: 2.5-7.6 mm
- For 2-step stripping

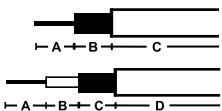

Code	No.	Execution	B	C	↔	📦
1830872	8149-2	2 steps	6.8		82	1
1830880	8149-3	3 steps	6.0	6.0	40	1

8146

STRIPPING PLIERS with exchangeable module inserts, self-adjusting

- Self-adjusting cutting and stripping tool (No. 8146) for modern electrical installations and equipment circuitry (90% of all wires can be stripped without any adjustment of the tool)
- The use of easily exchangeable module inserts allows accurate stripping of a wide range of insulation materials, including PVC and PTFE, with just one tool
- Flat blade included in delivery
- Dimensions: 191 x 123 x 20 mm
- **Stripping capacity:**
 - 8146-1 with flat blade: 0.02-10 mm² / AWG 34-8 (for PVC insulation)
 - 8146-2 with round blade: 4-16 mm² / AWG 12-6
 - 8146-3 with V blade: PTFE 0.1-4 mm² / AWG 26-12 (for all types of insulation)
- **Cutting values:**
 - Flexible wires up to 10 mm² / AWG 6
 - Rigid wires up to 1.5 mm² / AWG 16



Code	No.	Description	Cable cross section	AWG	↔	📦
1830805	8146	Stripping pliers incl. module insert 8146-1	0,02-10	34-8	180	1
1830813	8146-1	Module insert with flat blade	0,02-10	34-8	15	1
1830821	8146-2	Module insert with round blade	4-16	12-6	16	1
1830848	8146-3	Module insert with V-blade	0,1-4	26-12	16	1



8139

CABLE END-SLEEVE PLIERS

- For the simple pressing of conductor end-sleeves as per DIN 46228
- With a V-block for stripping and cutting soft wire (not included on model No. 8139-2-220)
- In heat-treated steel as per DIN
- TL = enamelled black, with blue dipped handle protectors



Code	No.	Cable cross section	↳ mm ↳	↳ Inch ↳	↻	📦
6723510	8139-155 TL	0,25-2,5	155	6	186	1
6723780	8139-220 TL	0,5-16	220	8.1/2	314	1
6723860	8139-2-220 TL	10-35	220	8.1/2	316	1

8152 - 8153

CRIMP WRENCH for big terminals

- Ratchet mechanism developed for uniform, reliable crimping of non-insulated crimp lug terminals to conductors and to secure completed crimping cycles and positive locking
- Assymetrical press inserts for optimal termination
- The press inserts mark the connector, to allow the correct use of the tool to be checked
- Long handles enable double-handed use and effortless crimping



Code	No.	Cable cross section	AWG	↳ mm ↳	↻	📦
2010313	8152	4-25	12-3	300	650	1
2010321	8153	10-75	7-2/0	500	2800	1

PRECISION CRIMP WRENCHES

- Well balanced tool design for easy handling
- Ergonomic handles for fatigue-free crimping
- Ratchet mechanism to secure completed crimping cycles



8141

PRECISION CRIMPING WRENCH for conductor end-sleeves



Code	No.	Cable cross section	↳ mm ↳	↳ Inch ↳	↻	📦
1830759	8141	0,5-6	197	7,75	423	1

8143 - 8144

PRECISION CRIMP WRENCH for non-insulated terminals



Code	No.	Cable cross section	↳ mm ↳	↳ Inch ↳	↻	📦
1830775	8143	0,35-2,5	212	8,35	536	1
1830783	8144	4-10	255	10,04	614	1

8142

PRECISION CRIMP WRENCH for insulated terminals



Code	No.	Cable cross section	↳ mm ↳	↳ Inch ↳	↻	📦
1830767	8142	0,5-6	255	10,04	626	1

8145

PRECISION CRIMP WRENCH for flat plugs



Code	No.	Cable cross section	↳ mm ↳	↳ Inch ↳	↻	📦
1830791	8145	0,5-6	255	10,04	628	1



CRIMPING PLIERS



8101, 8102, 8103

- For cutting, wire stripping, and crimping when working with insulated contacts with an open or closed crimping zone
- Integrated dead-point locking ensures complete crimping to the required profile
- Cutter for cables with a conductor cross-section up to 10.0 mm²
- Perfectly formed crimping area for all standard connector types. With correct use, pull-out values to EN 352/2 are easily archived



8102

CRIMPING SELF-GRIP WRENCH

- For non-insulated contacts with open crimping sleeves, such as flat plugs F 2.8 and F 6.3
- Lead and insulation crimp are carried out in one operation
- Section types/ Connector type:
 - Flat plug F 6.3
 - 1: 0,5-1,0 mm² / 20-16 AWG
 - 2: 1,5-2,5 mm² / 16-14 AWG
 - 3: 4,0-6,0 mm² / 12-10 AWG
 - Flat plug F 2.8
 - 4: 0,5-1,0 mm² / 20-16 AWG



Code	No.	Cable cross section	AWG	↳mm↳	↳Inch↳	🔧	📦
6724080	8102	0,5-6	20-10	215	8	572	1

8103

CRIMPING SELF-GRIP WRENCH

- For non-insulated contacts with closed crimping sleeves, such as eye lugs, pin terminals, butt and parallel connectors and miniature ring terminals
- Cutting values:
 - 1: 0,5-1,0 mm² / 20-16 AWG
 - 2: 1,5-2,5 mm² / 16-14 AWG
 - 3: 4,0-6,0 mm² / 12-10 AWG
 - 4: 10 mm² / 8 AWG



Code	No.	Cable cross section	AWG	↳mm↳	↳Inch↳	🔧	📦
6724160	8103	0,5-10	20-8	215	8	536	1

8101

CRIMPING SELF-GRIP WRENCH

- For red, blue and yellow insulated connectors, such as cable terminals, pin cable terminals, flat plugs, flat sockets, round plugs, round sockets, push connectors and parallel connectors
- With integrated three-stage positioner
- Step 1. Crimp the conductor in the profile intended for the colour (Conductor crimp = red, blue, or yellow)
- Step 2. Crimp the insulation in the next following profile (Insulation crimp = blue or yellow)
- The integrated three-stage positioner ensures the longitudinal positioning of the contact in the crimping section used
- The three-stage adjustment ist designed especially for the contacts, and shown as drawings on the positioner
- Cutting values:
 - 1: 0,5-1,0 mm² / 20-16 AWG
 - 2: 1,5-2,5 mm² / 16-14 AWG
 - 3: 4,0-6,0 mm² / 12-10 AWG



Code	No.	Cable cross section	AWG	↳mm↳	↳Inch↳	🔧	📦
6723940	8101	0,5-6	20-10	215	8	556	1

S 8905 BASIS • UNI • S 8910 LKW



578





CRIMP WRENCH MODULAR



Advantages:

- Reliable: parallel action ensures precision crimping
- Easy to handle: components kept in view throughout the crimping process, easily accessible release function allows quick change of insert modules without the use of additional tools
- Comfortable: lightweight, plastic-sheathed tool frame for comfort grip - even at low temperatures
- Practical: insert modules, easy to change and clearly labelled, supplied in pairs on an pin in a storage box to prevent loss (storage boxes interconnect - like in a jigsaw puzzle)
- Versatile and economical: just one tool base frame can be used with all the various insert modules to carry out a wide range of crimping processes, including heavy plug and socket connectors, coaxial connectors, optic fibres and RJ45 plugs.



Changing of the crimping inserts

- By pressing the release of the crimping insert you can easily remove the crimping insert.
- Remove the crimping insert and put in the required crimping insert while pressing down the release.



8140

MODULAR CRIMP WRENCH

- Professional ratchet crimping pliers for most types of mechanical, electrical and electronic connectors
- Just one tool base frame (No. 8140) can be used with all insert modules
- Dimensions: L 234 x H 64 x W 24 mm
- Module inserts changeable without tools



Code	No.	mm	mm	mm
1830546	8140	234	557	1

8140-01/-02

MODULE INSERT for insulated terminals

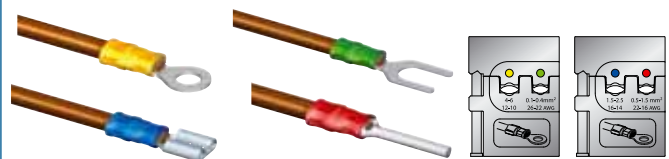

Code	No.	Cable cross section	AWG	mm	mm
1830554	8140-01	0,1-0,4 + 4-6	26-22 + 12-10	75	1
1830562	8140-02	0,5-1,5 + 1,5-2,5	22-16 + 16-14	68	1

8140-03/-04/-05

MODULE INSERT for non-insulated terminals

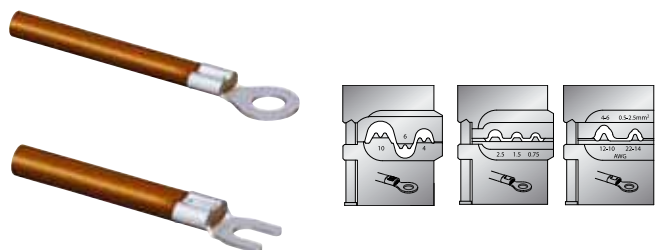

Code	No.	Cable cross section	AWG	mm	mm
1830570	8140-03	4-6-10	12-10-8	56	1
1830589	8140-04	0,75-1,5-2,5		76	1
1830597	8140-05	0,5-2,5 + 4-6	22-14 + 12-10	56	1



**8140-06/-07/-08**

MODULE INSERT for conductor end-sleeves

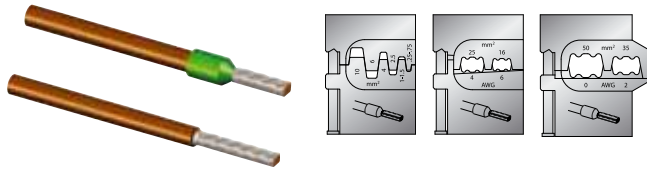

Code	No.	Cable cross section	AWG	56	1
1830600	8140-06	0,25-10		56	1
1830619	8140-07	16-25	6-4	56	1
1830627	8140-08	35-50	2-0	56	1

8140-09/-10/-11

MODULE INSERT for flat plugs

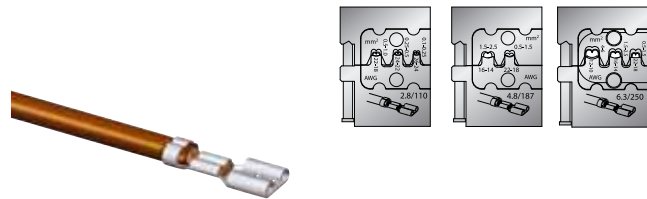

Code	No.	Connector type	Cable cross section	AWG	72	56	80
1830635	8140-09	for flat plugs 2.8	0,1-1	26-18	72	1	
1830643	8140-10	for flat plugs 4.8	0,5-2,5	22-14	56	1	
1830651	8140-11	for flat plugs 6.3	0,5-6	22-10	80	1	

8140-12

MODULE INSERT for optical waveguides



Code	No.	Ø	1	56
1830678	8140-12	4,52 5,41 3,84 3,25 mm .178 .213 .151 .128 in	1	56

8140-13/-14/-15

MODULE INSERT for coax cables

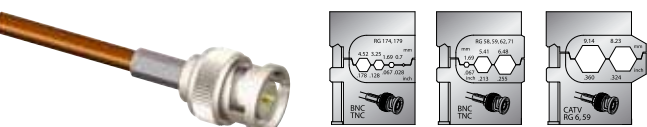

Code	No.	Connector type	Ø	56	1
1830686	8140-13	for coax cables RG 174, 179	4,52 3,25 1,69 0,7 mm .178 .128 .067 .028 in	56	1
1830694	8140-14	for coax cables RG 58, 59, 62, 71	1,69 5,41 6,48 mm .067 .213 .255 in	56	1
1830708	8140-15	for coax cables RG 6, 59	9,14 - 8,23 mm .360 - .324 in	56	1

8140-16/-17

MODULE INSERT for modular plugs



Code	No.	Use	50	48	1
1830716	8140-16	RJ-45, 8P/8C	50	1	
1830724	8140-17	RJ-11, 6P/6C - 6P/4C - 6P/2C	48	1	

8140-18/-19

MODULE INSERT for heavy connectors



Code	No.	Cable cross section	AWG	56	1
1830732	8140-18	0,14-4	26-12	56	1
1830740	8140-19	6-10	10-8	56	1

8140-20

MODULE INSERT for lamellar contacts

► With seals 0.5-3.0 mm²

Code	No.	Cable cross section	AWG	56	1
1963384	8140-20	0,5-3,0	20-12	56	1

8140-21/-22

MODULE INSERT for Dura Seal contacts



Code	No.	Cable cross section	AWG	80	1
1963392	8140-21	0,5 - 1,5 / 1,5 - 2,5	22 - 16 / 16 - 14	80	1
1963406	8140-22	0,32 - 0,75 / 4 - 6	22 - 18 / 12 - 10	80	1

8140-23

MODULE INSERT for Solarlok®

► Suitable for Tyco Solarlok®: 2.5 - 4 - 6 mm²

Code	No.	86	1
2078082	8140-23	86	1

8140-24/-25

MODULE INSERT for Multi Contact

► Suitable for Multi Contact MC 3 / MC 4: 2.5 - 4 - 6 mm²

Code	No.	Use	56	700	1
2078090	8140-24	Multi Contact MC 3	56	1	
2078104	8140-25	Multi Contact MC 4	700	1	



CRIMP WRENCH SETS

S 8140 A

CRIMPING PLIERS SET AUTOMOTIVE 4 pieces

- Practical set made up for specific requirements in automotive engineering
- Ideal for high-standard crimping
- Can be individually upgraded by purchasing additional module inserts
- Module inserts changeable without tools
- In practical blister packaging

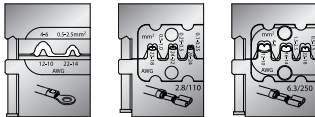

Code	No.	Contents	↕	📦
1830910	S 8140 A	8140 8140-09 -05 -11	754	1

S 8140 J

CRIMPING PLIERS SET INDUSTRIAL 4 pieces

- Practical set made up for specific requirements in industrial maintenance
- Ideal for high-standard crimping
- Can be individually upgraded by purchasing additional module inserts
- Module inserts changeable without tools
- In practical blister packaging

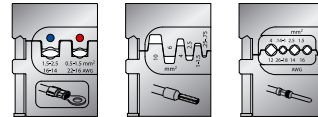

Code	No.	Contents	↕	📦
1830929	S 8140 J	8140 8140-02 -06 -18	752	1

S 8140 D

CRIMPING PLIERS SET DATA COM 4 pieces

- Practical set made up for specific requirements in data-communications installations
- Ideal for high-standard crimping
- Can be individually upgraded by purchasing additional module inserts
- Module inserts changeable without tools
- In practical blister packaging

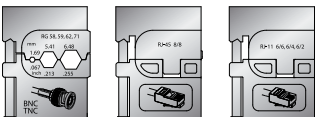

Code	No.	Contents	↕	📦
1830937	S 8140 D	8140 8140-14 -16 -17	711	1

S 8140 E

CRIMPING PLIERS SET ELECTRONIC 4 pieces

- Practical set made up for specific requirements for electricians
- Ideal for high-standard crimping
- Can be individually upgraded by purchasing additional module inserts
- Module inserts changeable without tools
- In practical blister packaging

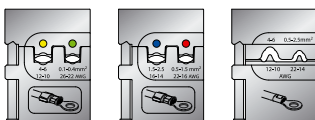

Code	No.	Contents	↕	📦
1830899	S 8140 E	8140 8140-01 -02 -05	760	1

S 8140 PA

CRIMPING PLIERS SET PROFESSIONAL AUTOMOTIVE 9 pieces in plastic case

- Practical set made up for specific requirements in automotive engineering
- Ideal for high-standard crimping
- Can be individually upgraded by purchasing additional module inserts
- Module inserts changeable without tools
- In practical plastic case

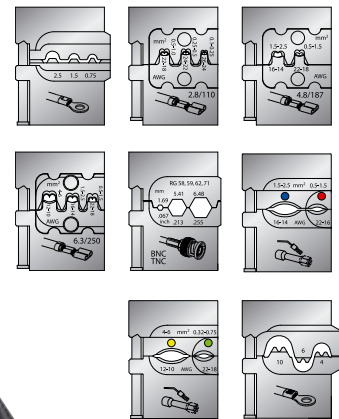

Code	No.	Contents	↕	📦
1954121	S 8140 PA	8140 8140-03 -04 -09 -10 -11 -14 -21 -22	2150	1





S 8140 PE

CRIMPING PLIERS SET PROFESSIONAL ELECTRONIC 9 pieces in plastic case

- Practical set made up for specific requirements for electricians
- Ideal for high-standard crimping
- Can be individually upgraded by purchasing additional module inserts
- Module inserts changeable without tools
- In practical plastic case



Code	No.	Contents	1589	1
1954148	S 8140 PE	8140 8140-01 -02 -06 -11 -14 -16 -18 -19	2150	1

RZB1-18CR

PLIERS SET 2 pieces + accessories

- In rugged plastic case



Code	No.	Contents	1480	1
1895249	RZB1-18CR	8141 8146 End-sleeves 0.50 0.75 1.00 1.50 2.50 4.00 6.00	1480	1

S 8140 PN

CRIMPING PLIERS SET PROFESSIONAL in plastic case

- Without module inserts for individual composition
- In practical plastic case



Code	No.	1589	1
1963279	S 8140 PN	1589	1

Code	No.	Ø mm² / AWG		1954121	1954148	1830910	1830899	1830929	1830937
				S 8140 PA	S 8140 PE	S 8140 A	S 8140 E	S 8140 J	S 8140 D
1830546	8140								
1830554	8140-01	0,1-0,4 + 4-6 / 26-22 + 12-10							
1830562	8140-02	0,5-1,5 + 1,5-2,5 / 22-16 + 16-14							
1830570	8140-03	4-6-10-							
1830589	8140-04	0,75-1,5-2,5							
1830597	8140-05	0,5-2,5 + 4-6 / 22-14 + 12-10							
1830600	8140-06	0,25-10							
1830635	8140-09	0,1-1 / 26-18							
1830643	8140-10	0,5-2,5 / 22-14							
1830651	8140-11	0,5-6 / 22-10							
1830694	8140-14	1,69 5,41 6,48 / 0,067 0,213 0,255							
1830716	8140-16	RJ-45 8/8							
1830724	8140-17	RJ-11 6/6 6/4 6/2							
1830732	8140-18	0,14-4 / 26-12							
1830740	8140-19	6-10 / 10-8							
1963392	8140-21	0,5-2,5							
1963406	8140-22	0,32-6,0							



CIRCLIP PLIERS FOR EXTERNAL RETAINING RINGS (SHAFTS)

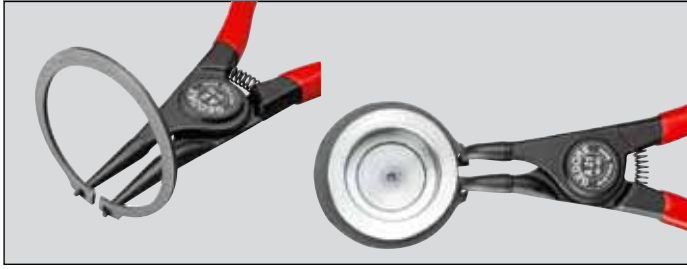

8000 A 0G - A 2G

CIRCLIP PLIERS FOR EXTERNAL RETAINING RINGS

- For shafts without groove
- For retaining rings Seeger as well as Benzing
- Similar to DIN 5254 Form A
- A 0G - A 1G = tips angled 30°
- A 2G = straight tips
- With opening spring and adjusting screw to limit opening
- High degree of assembly reliability, the limit opening rules out any over-tensioning of the smallest of retaining rings
- Forged GEDORE chrome-vanadium special hardened and tempered steel
- Precision machined, oil hardened and annealed
- Black, with red dipped handles

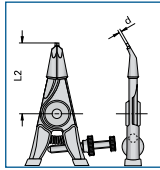

Code	No.	for Seeger circlips		for Benzing clamping circlips		L	L ₂	d	↔	↕
		● mm	● mm	● mm	● mm					
6700140	8000 A 0G	1,5-3,5	1,5-3,5	140	40	0.7	99	5		
6700220	8000 A 1G	4,0-9,0	3,0-11,0	140	40	1.1	98	5		
6700300	8000 A 2G	10,0-15,0	12,0-16,0	182	57	1.8	189	5		

8000 A 01G - A 21G

CIRCLIP PLIERS FOR EXTERNAL RETAINING RINGS

- For shafts without groove
- For retaining rings Seeger as well as Benzing
- Similar to DIN 5254 Form B
- 90° angled tips
- With opening spring and adjusting screw to limit opening
- High degree of assembly reliability, the limit opening rules out any over-tensioning of the smallest of retaining rings
- Forged GEDORE chrome-vanadium special hardened and tempered steel
- Precision machined, oil hardened and annealed
- Black, with red dipped handles

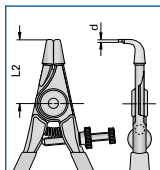

Code	No.	for Seeger circlips		for Benzing clamping circlips		L	L ₂	d	↔	↕
		● mm	● mm	● mm	● mm					
6700650	8000 A 01G	1,5-3,5	1,5-3,5	134	33	0.7	100	5		
6700730	8000 A 11G	4,0-9,0	3,0-11,0	134	33	1.1	99	5		
6700810	8000 A 21G	10,0-15,0	12,0-16,0	170	45	1.8	184	5		

8000 A 0 - A 4

CIRCLIP PLIERS FOR EXTERNAL RETAINING RINGS Form A

- For retaining rings as per DIN 471, DIN 983
- DIN 5254 Form A
- Straight tips
- With opening spring
- With clamping protection
- Forged GEDORE chrome-vanadium special hardened and tempered steel
- Precision machined, oil hardened and annealed
- Black, with red dipped handles

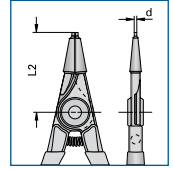

Code	No.	● mm	● inch	L	L ₂	d	↔	↕
6701380	8000 A 0	3-10	5/32-3/8	141	40.0	0.9	96	5
6701460	8000 A 1	10-25	3/8-1	141	40.0	1.3	98	5
6701540	8000 A 2	19-60	3/4-2.3/8	182	54.0	1.8	186	5
6701620	8000 A 3	40-100	1.5/8-4	230	69.0	2.3	310	1
6701700	8000 A 4	85-140	3.3/8-5.1/2	320	85.5	3.2	555	1

8010 A 0 - A 4

CIRCLIP PLIERS FOR EXTERNAL RETAINING RINGS Form A

- For retaining rings as per DIN 471, DIN 983
- DIN 5254 Form A
- Straight tips
- With opening spring
- With clamping protection
- Forged GEDORE chrome-vanadium special hardened and tempered steel
- Precision machined, oil hardened and annealed
- Chrome-plated, with red dipped handles

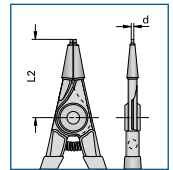

Code	No.	● mm	● inch	L	L ₂	d	↔	↕
6704800	8010 A 0	3-10	5/32-3/8	141	40.0	0.9	97	5
6704990	8010 A 1	10-25	3/8-1	141	40.0	1.3	96	5
6705020	8010 A 2	19-60	3/4-2.3/8	182	54.0	1.8	182	5
6705100	8010 A 3	40-100	1.5/8-4	230	69.0	2.3	312	1
6705290	8010 A 4	85-140	3.3/8-5.1/2	320	85.5	3.2	562	1

8000 A 01 - A 41

CIRCLIP PLIERS FOR EXTERNAL RETAINING RINGS Form B

- For retaining rings as per DIN 471, DIN 983
- DIN 5254 Form B
- 90° angled tips
- With opening spring
- With clamping protection
- Forged GEDORE chrome-vanadium special hardened and tempered steel
- Precision machined, oil hardened and annealed
- Black, with red dipped handles

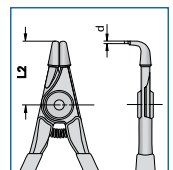
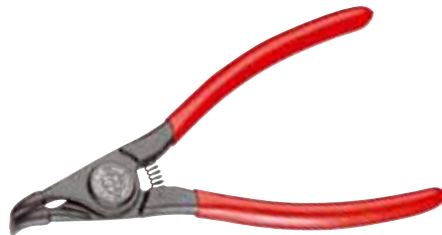

Code	No.	● mm	● inch	L	L ₂	d	↔	↕
6702270	8000 A 01	3-10	5/32-3/8	130	29	0.9	97	5
6702350	8000 A 11	10-25	3/8-1	130	29	1.3	97	5
6702430	8000 A 21	19-60	3/4-2.3/8	170	43	1.8	182	5
6702510	8000 A 31	40-100	1.5/8-4	210	53	2.3	317	1
6702780	8000 A 41	85-140	3.3/8-5.1/2	305	64	3.2	563	1



8010 A 01 - A 41

CIRCLIP PLIERS FOR EXTERNAL RETAINING RINGS Form B

- ▶ For retaining rings as per DIN 471, DIN 983
- ▶ DIN 5254 Form B
- ▶ 90° angled tips
- ▶ With opening spring
- ▶ With clamping protection
- ▶ Forged GEDORE chrome-vanadium special hardened and tempered steel
- ▶ Precision machined, oil hardened and annealed
- ▶ Chrome-plated, with red dipped handles

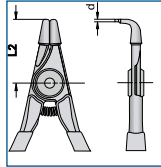

Code	No.	● mm	● inch	L	L ₂	d	↔ mm	↔ inch
6705960	8010 A 01	3-10	5/32-3/8	130	29	0.9	96	5
6706180	8010 A 11	10-25	3/8-1	130	29	1.3	97	5
6706260	8010 A 21	19-60	3/4-2.3/8	170	43	1.8	186	5
6706340	8010 A 31	40-100	1.5/8-4	210	53	2.3	328	1
6706930	8010 A 41	85-140	3.3/8-5.1/2	305	64	3.2	568	1

8000 A 02 - A 42

CIRCLIP PLIERS FOR EXTERNAL RETAINING RINGS

- ▶ Similar to DIN 5254 Form B
- ▶ 45° angled tips
- ▶ With opening spring
- ▶ With clamping protection
- ▶ Forged GEDORE chrome-vanadium special hardened and tempered steel
- ▶ Precision machined, oil hardened and annealed
- ▶ Chrome-plated, with red dipped handles



Code	No.	● mm	● inch	L	L ₂	d	↔ mm	↔ inch
2015021	8000 A 02	3-10	5/32-3/8	139	38.0	0.9	97	5
2015048	8000 A 12	10-25	3/8-1	139	38.0	1.3	97	5
2015056	8000 A 22	19-60	3/4-2.3/8	179	51.0	1.8	182	5
2015064	8000 A 32	40-100	1.5/8-4	226	65.0	2.3	317	1
2015072	8000 A 42	85-140	3.3/8-5.1/2	315	80.5	3.2	568	1



8000 A 41 - A 61

CIRCLIP PLIERS FOR EXTERNAL RETAINING RINGS

- ▶ 90° angled tips
- ▶ Black powder-coated
- ▶ Tips and lock lever zinc-plated
- ▶ Lever handle-end red dip-insulated
- ▶ Finger protection
- ▶ Reinforced safety arms
- ▶ Forged GEDORE chrome-vanadium special hardened and tempered steel
- ▶ Precision machined, oil hardened and annealed

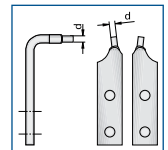

Code	No.	● mm	● inch	d	↔ mm	↔ inch
2011786	8000 A 41 EL	85-140	3.3/8-5.1/2	3.2	560	1898
6702860	8000 A 51	122-300	4.13/16-11.7/8	3.5	560	1898
6718430	8000 A 61	252-400	9.15/16-15.13/16	4.5	585	1953
2011697	E-8000 A 41 EL			3.2	72	1
5702810	E-8000 A 51			3.5	112	1
5701760	E-8000 A 61			4.5	140	1

8000 A 4 - A 6

CIRCLIP PLIERS FOR EXTERNAL RETAINING RINGS

- ▶ Straight tips
- ▶ Black, tips and lock lever zinc-plated
- ▶ Lever handle-end red dip-insulated
- ▶ Finger protection
- ▶ Reinforced safety arms
- ▶ Forged GEDORE chrome-vanadium special hardened and tempered steel
- ▶ Precision machined, oil hardened and annealed

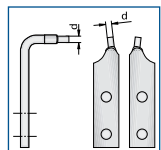

Code	No.	● mm	● inch	d	↔ mm	↔ inch
2011778	8000 A 4 EL	85-140	3.3/8-5.1/2	3.2	550	1921
6701890	8000 A 5	122-300	4.13/16-11.7/8	3.5	550	1921
6701970	8000 A 6	252-400	9.15/16-15.13/16	4.5	586	1922
2011670	E-8000 A 4 EL			3.2	72	1
5701840	E-8000 A 5			3.5	72	1
5701920	E-8000 A 6			4.5	112	1



923



487



CIRCLIP PLIERS FOR INTERNAL RETAINING RINGS (BORES)



8000 J 0 - J 4

CIRCLIP PLIERS FOR INTERNAL RETAINING RINGS Form C

- For retaining rings as per DIN 472, DIN 984
- DIN 5256 Form C
- Straight tips
- Forged GEDORE chrome-vanadium special hardened and tempered steel
- Precision machined, oil hardened and annealed
- Black, with blue dipped handles

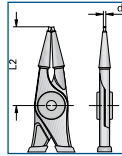
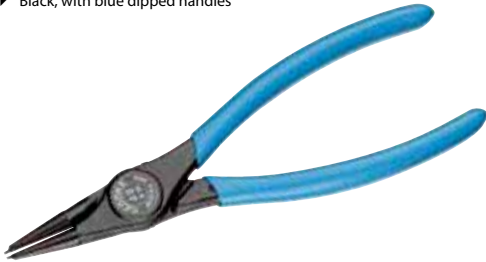

Code	No.	Ø mm	Ø inch	L	L ₂	d	↔	⊞
6703240	8000 J 0	8-13	3/8-9/16	141	41.0	0.9	80	5
6703320	8000 J 1	12-25	3/8-1	141	41.0	1.3	81	5
6703400	8000 J 2	19-60	3/4-2.3/8	183	54.0	1.8	164	5
6703590	8000 J 3	40-100	1.5/8-4	230	68.0	2.3	281	1
6703670	8000 J 4	85-140	3.3/8-5.1/2	322	84.5	3.2	472	1

8010 J 0 - J 4

CIRCLIP PLIERS FOR INTERNAL RETAINING RINGS Form C

- For retaining rings as per DIN 472, DIN 984
- DIN 5256 Form C
- Straight tips
- Forged GEDORE chrome-vanadium special hardened and tempered steel
- Precision machined, oil hardened and annealed
- Chrome-plated, with blue dipped handles

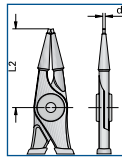

Code	No.	Ø mm	Ø inch	L	L ₂	d	↔	⊞
6705370	8010 J 0	8-13	3/8-9/16	141	41.0	0.9	81	5
6705450	8010 J 1	12-25	3/8-1	141	41.0	1.3	80	5
6705530	8010 J 2	19-60	3/4-2.3/8	183	54.0	1.8	163	5
6705610	8010 J 3	40-100	1.5/8-4	230	68.0	2.3	281	1
6705880	8010 J 4	85-140	3.3/8-5.1/2	322	84.5	3.2	472	1

8000 J 01 - J 41

CIRCLIP PLIERS FOR INTERNAL RETAINING RINGS Form D

- For retaining rings as per DIN 472, DIN 984
- DIN 5256 Form D
- 90° angled tips
- Forged GEDORE chrome-vanadium special hardened and tempered steel
- Precision machined, oil hardened and annealed
- Black, with blue dipped handles

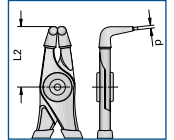

Code	No.	Ø mm	Ø inch	L	L ₂	d	↔	⊞
6704130	8000 J 01	8-13	3/8-9/16	129	28	0.9	80	5
6704210	8000 J 11	12-25	3/8-1	129	28	1.3	82	5
6704480	8000 J 21	19-60	3/4-2.3/8	169	41	1.8	161	5
6704560	8000 J 31	40-100	1.5/8-4	214	50	2.3	279	1
6704640	8000 J 41	85-140	3.3/8-5.1/2	292	65	3.2	484	1

8010 J 01 - J 41

CIRCLIP PLIERS FOR INTERNAL RETAINING RINGS Form D

- For retaining rings as per DIN 472, DIN 984
- DIN 5256 Form D
- 90° angled tips
- Forged GEDORE chrome-vanadium special hardened and tempered steel
- Precision machined, oil hardened and annealed
- Chrome-plated, with blue dipped handles

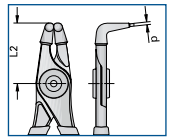
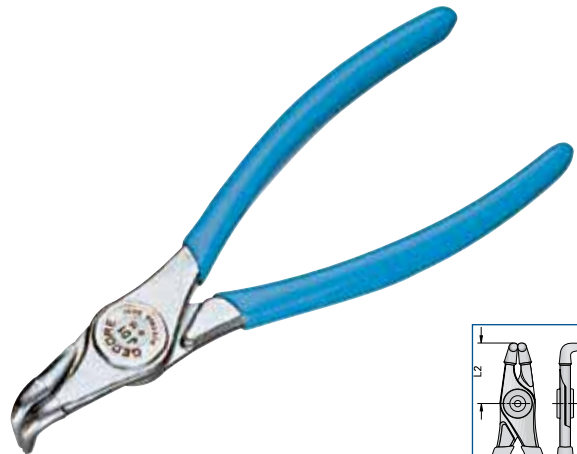

Code	No.	Ø mm	Ø inch	L	L ₂	d	↔	⊞
6706420	8010 J 01	8-13	3/8-9/16	129	28	0.9	89	5
6706500	8010 J 11	12-25	3/8-1	129	28	1.3	81	5
6706690	8010 J 21	19-60	3/4-2.3/8	169	41	1.8	163	5
6706770	8010 J 31	40-100	1.5/8-4	214	50	2.3	282	1
6706850	8010 J 41	85-140	3.3/8-5.1/2	292	65	3.2	511	1

S 8028



356

1500 ES-8000

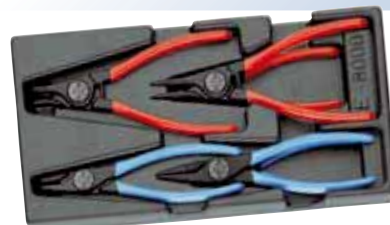

89



8000 J 02 - J 42

CIRCLIP PLIERS FOR INTERNAL RETAINING RINGS

- Similar to DIN 5256 Form D
- 45° angled tips
- Forged GEDORE chrome-vanadium special hardened and tempered steel
- Precision machined, oil hardened and annealed
- Chrome-plated, with blue dipped handles



Code	No.	Ø mm	Ø inch	L	L ₂	d	↔	⊞
2014963	8000 J 02	8-13	3/8-9/16	139	39.0	0.9	80	5
2014971	8000 J 12	12-25	3/8-1	139	39.0	1.3	80	5
2014998	8000 J 22	19-60	3/4-2.3/8	180	52.0	1.8	161	5
2015005	8000 J 32	40-100	1.5/8-4	226	64.0	2.3	279	1
2015013	8000 J 42	85-140	3.3/8-5.1/2	316	78.5	3.2	484	1



8000 J 4 - J 6 / 8000 J 41 - J 61 Circlip pliers for internal retaining rings

3.2/3.5/4.5 mm tip diameters available for 85 to 400 mm rings. Models for internal and external retaining rings

Release lever for controlled slackening of the tension

Ratcheting mechanism for easing the work of the user when fitting the retaining rings

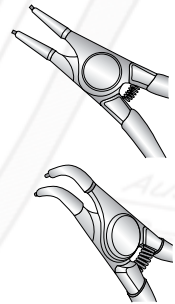

8000 J 41 - J 61

CIRCLIP PLIERS FOR INTERNAL RETAINING RINGS

- For circlips as per DIN 472, DIN 984
- 90° angled tips
- Black, tips and lock lever zinc-plated
- Lever handle-end blue dip-insulated
- Finger protection
- Reinforced safety arms
- Forged GEDORE chrome-vanadium special hardened and tempered steel
- Precision machined, oil hardened and annealed
- E-8000 J = pair of spare tips

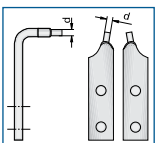

Code	No.	Ø mm	Ø inch	d	↳ mm ↳	↔	⊞
2011808	8000 J 41 EL	85-140	3.3/8-5.1/2	3.2	575	1953	1
6704720	8000 J 51	122-300	4.13/16-11.7/8	3.5	575	1953	1
6718510	8000 J 61	252-400	9.15/16-15.13/16	4.5	579	1934	1
2011719	E-8000 J 41 EL			3.2		72	1
5704780	E-8000 J 51			3.5		116	1
5702730	E-8000 J 61			4.5		116	1

8000 J 4 - J 6

CIRCLIP PLIERS FOR INTERNAL RETAINING RINGS

- For circlips as per DIN 472, DIN 984
- Straight tips
- Black, tips and lock lever zinc-plated
- Lever handle-end blue dip-insulated
- Finger protection
- Reinforced safety arms
- Forged GEDORE chrome-vanadium special hardened and tempered steel
- Precision machined, oil hardened and annealed
- E-8000 J = pair of spare tips

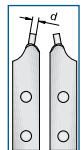
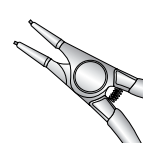

Code	No.	Ø mm	Ø inch	d	↳ mm ↳	↔	⊞
2011794	8000 J 4 EL	85-140	3.3/8-5.1/2	3.2	565	1835	1
6703750	8000 J 5	122-300	4.13/16-11.7/8	3.5	565	1836	1
6703830	8000 J 6	252-400	9.15/16-15.13/16	4.5	575	1846	1
2011700	E-8000 J 4 EL			3.2		72	1
5703700	E-8000 J 5			3.5		72	1
5703890	E-8000 J 6			4.5		82	1



CIRCLIP PLIERS FOR RETAINING RINGS (PARALLEL)

8005 A

CIRCLIP PLIERS FOR EXTERNAL RETAINING RINGS

- For shafts
- Supplied with four different clamping tips
- The circlip is securely clamped before removal by choosing a suitable distance between the clamping tips. This means that unnecessary plier movement is avoided, and the circlip may be opened completely. The special parallel movement of the clamping tips and their recesses in the direction of the pressure applied ensure that the circlip will be clamped firmly.
- DBGM (= German Utility Patent)

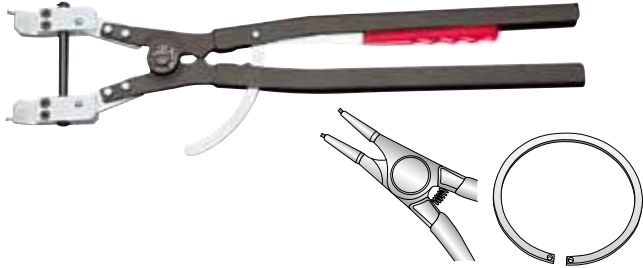

Code	No.	mm	mm	mm	mm	mm	mm
6707150	8005 A	305-500	4,5	5,9	665	3520	1

8005 J

CIRCLIP PLIERS FOR INTERNAL RETAINING RINGS

- For bores
- Supplied with six different clamping tips
- The circlip is securely clamped before removal by choosing a suitable distance between the clamping tips. This means that unnecessary plier movement is avoided, and the circlip may be opened completely. The special parallel movement of the clamping tips and their recesses in the direction of the pressure applied ensure that the circlip will be clamped firmly.
- DBGM (= German Utility Patent)

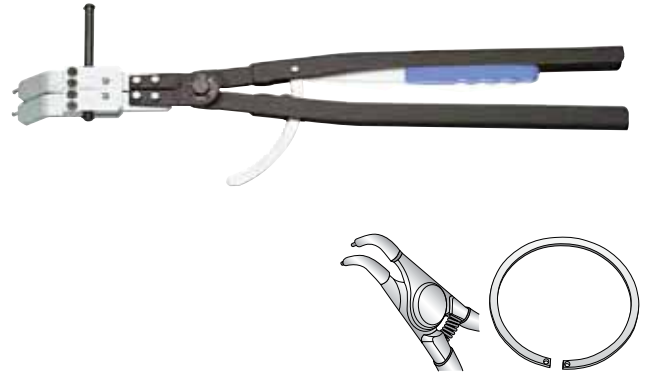

Code	No.	mm	mm	mm	mm	mm	mm
6707230	8005 J	305-500	4,5	5,9	705	3885	1



8005 A Pliers for external retaining rings

For holes from 4.5 to 5.9 mm and rings from 305 to 500 mm

Paralleled jaws for the greatest possible safety and torsion-free clamping

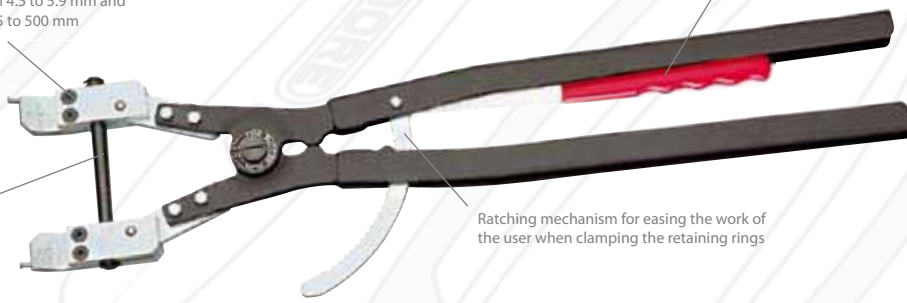

Ratcheting mechanism for easing the work of the user when clamping the retaining rings

Release lever for controlled slackening of the tension

E-8005 A

SPARE TIPS for external retaining rings (per piece)

Instructions for use:

- The spacing of holes for non-tensioned circlips is normally between 20 mm and 50 mm
- The tips used to spread the rings are fitted to match the opening width of the non-tensioned circlip
- Opening widths 18-28 mm: Combination tips E-8005 1 A and E-8005 2 A
- Opening widths 29-39 mm: Combination tips E-8005 1 A and E-8005 4 A
- Opening widths 40-50 mm: Combination tips E-8005 3 A and E-8005 4 A

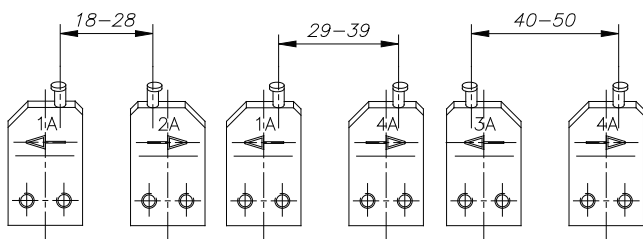

Code	No.	mm	mm
5700790	E-8005 1 A	68	1
5702220	E-8005 2 A	68	1
5702300	E-8005 3 A	68	1
5702490	E-8005 4 A	68	1

E-8005 J

SPARE TIPS for internal retaining rings (per piece)

Instructions for use:

- The spacing of holes for non-tensioned circlips is normally between 80 mm and 140 mm
- The tips used to spread the rings are fitted to match the opening width of the non-tensioned circlip
- Opening widths 140-125 mm: Combination tips E-8005 1 J and E-8005 2 J
- Opening widths 125-110 mm: Combination tips E-8005 1 J and E-8005 4 J
- Opening widths 110-95 mm: Combination tips E-8005 3 J and E-8005 4 J
- Opening widths 95-80 mm: Combination tips E-8005 5 J and E-8005 6 J

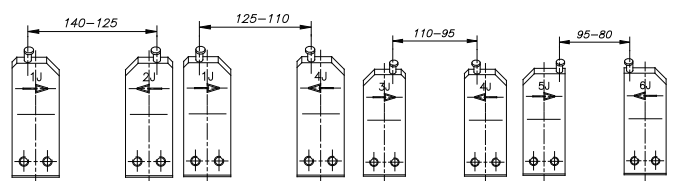

Code	No.	mm	mm
5703380	E-8005 1 J	116	1
5703460	E-8005 2 J	116	1
5704190	E-8005 3 J	116	1
5703540	E-8005 4 J	113	1
5703620	E-8005 5 J	116	1
5703970	E-8005 6 J	116	1

**CIRCLIP PLIERS X-GRIP****8006 X-GRIP****8006****X-GRIP CIRCLIP PLIERS**

- Universal circlip pliers for risk-free gripping and fitting of internal and external circlips (DIN 471/472) from 252 to 1000 mm diameter
- Particularly suited for working in confined spaces. Instead of using a long lever, the required force is transmitted by a threaded spindle. This ensures safe, fatigue-free gripping. Operated by a 15 mm open ended spanner or a 3/8" ratchet (e.g. 3093 Z-94)
- Solid, hardened sliding bar ensures parallel tip action
- Stop lugs reliably prevent circlips slipping off
- Quick changeover between internal and external circlips by rotating tips through 180°
- Tips made from tempering steel, carefully hardened and annealed, easy to replace
- DBGM



Code	No.	●mm	○mm	○mm	🔧	📦
1394401	8006	252-1000	4.5	5,9	3040	1

S 8006**X-GRIP CIRCLIP PLIERS SET**

- Universal circlip pliers for risk-free gripping and fitting of internal and external circlips (DIN 471/472) from 252 to 1000 mm diameter
- Plier with adaptor, basic body - no. 1/2+ tip Ø 5.9 mm and no. 3/4 + tip Ø 4.5 mm
- Special tools for changing tips and adaptors
- Single open ended spanner no. 894 10 + 894 15
- Hexagon socket key no. 42 2 mm
- 4 Spare threaded pins M4x4
- Ratchet no. 3093 Z-94 (for quick adjustment)
- Plastic box E-1000 P
- Rugged sheet steel case with foam insert

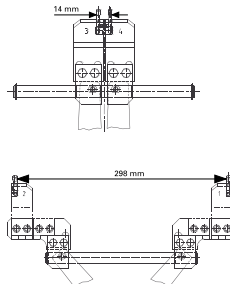

Code	No.	🔧	📦
1896237	S 8006	7300	1

E-8006**X-GRIP PARTS**

Code	No.	Description	🔧	📦
1575333	E-8006 1	Basic body no. 1 with spare tip 5.9 mm Ø	80	1
1575341	E-8006 2	Basic body no. 2 with spare tip 5.9 mm Ø	80	1
1896245	E-8006 3	Basic body no. 3 with spare tip 4.5 mm Ø	117	1
1896253	E-8006 4	Basic body no. 4 with spare tip 4.5 mm Ø	117	1
1896369	E-8006 X 4,5	Spare tip 4.5 mm Ø	5	1
1896350	E-8006 X 5,9	Spare tip 5.9 mm Ø	5	1
1910620	E-8006 X	Spindle with spindle bearing, 265 mm long	470	1

**920 · 922 · 923****487**



GRIP WRENCHES

137

GRIP WRENCH

- ▶ With adjusting screw and release lever, model 137 10 with blue dip-insulated lever
- ▶ Forged, tempered jaws and special jaw shape for secure gripping, clamping and holding
- ▶ GEDORE vanadium steel 31CrV3, nickel-plated
- ▶ Jaw body in high-tensile sheet steel
- ▶ Automatically welded upper jaw - absolutely firm connection with the sheet steel body
- ▶ Well-conceived jaw design guarantees a three-point contact with all material cross-sections
- ▶ Threaded bore welded at bottom
- ▶ No widening under most extreme loading
- ▶ Safe release
- ▶ Release lever under constant pressure of special spring



Code	No.	mm	inch	mm	inch	mm	inch
6406620	137 7	185	7	25	1	288	5
6406700	137 10	230	10	32	1.1/4	526	5
6407270	137 11	260	11	45	1.3/4	790	1
6406890	137 12	300	12	45	1.3/4	1042	1

137 K

SPECIAL BODY GRIP WRENCH

- ▶ All 3 models with adjusting screw and dip-insulated release lever (blue), nickel-plated
- ▶ 137 K1: Special jaws with flat clamping surfaces, 48x25 mm at top, 12x12 mm at bottom
- ▶ 137 K2: Special jaws with domed clamping surfaces, 25x20 mm at top, 12x12 mm at bottom
- ▶ 137 K3: Special jaws with flat clamping surfaces, 40x14 mm at top, 40x35 mm at bottom



Code	No.	mm	inch
1736531	137 K1	596	1
1736558	137 K2	560	1
1736566	137 K3	676	1

139

SPECIAL GRIP WRENCH

- ▶ With movable lower jaw for clamping over a large area
- ▶ Release lever blue dip-insulated
- ▶ Nickel-plated



Code	No.	mm	inch	mm	inch	mm	inch
6407940	139	250	10	45	1.3/4	577	1

136 BM

WIDE JAW GRIP WRENCH

- ▶ For clamping edges and surfaces
- ▶ 80 mm jaw width
- ▶ Nickel-plated



Code	No.	mm	inch	mm	inch	mm	inch
6406030	136 BM	200	8	30	1.1/4	416	1

137 KR

GRIP WRENCH, LONG JAWS

- ▶ With narrow jaws
- ▶ For working in confined spaces
- ▶ For clamping air and brake lines up to Ø 10 mm, copper lines Ø 12 mm
- ▶ Nickel-plated



Code	No.	mm	mm	mm	inch
1954113	137 KR-7	210	292		1
1868039	137 KR-10	255	540		1

137 P

PARALLEL JAW GRIP WRENCH

- ▶ 137 P With toothed jaws, for parallel clamping, with adjustment screw and release lever, jaw width 14 mm, jaw length 30 mm
- ▶ 137 PA With smooth jaws for plumbing fittings and sensitive surfaces, jaws = 8 x 29 mm, nickel-plated



Code	No.	mm	inch	mm	inch	mm	inch
6407000	137 P	250	10	50	2	701	1
6407190	137 PA	250	10	50	2	691	1

137 MSP

MACHINE WORKBENCH CLAMP

- ▶ For fast, secure clamping of a variety of workpieces
- ▶ Suitable for tenon blocks threaded M8, M10 or M12
- ▶ GEDORE special vanadium steel, nickel-plated
- ▶ Release lever dip-insulated
- ▶ Tenon block not included



Code	No.	mm	inch	mm	inch	mm	inch
6408080	137 MSP	280	11	100	4	790	1



136 SP

GRIP C-CLAMP

- For clamping extra deep workpieces
- With stop to fix the upper jaw at a constant position for repetition clamping
- Nickel-plated

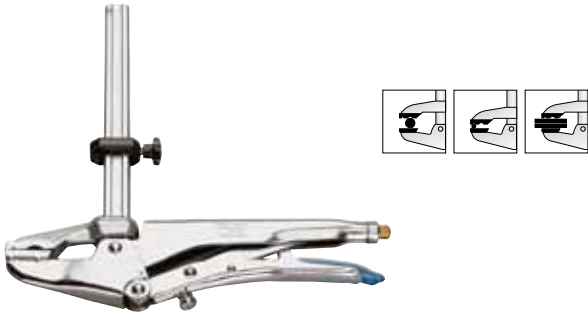

Code	No.	mm	inch	mm	inch	mm	inch	mm	inch
6406380	136 SP-100	260	10	100	4	1086	1		
6406540	136 SP-200	260	10	200	8	1254	1		

137 T

GRIP WRENCH FOR GLUEING

- For clamping lengthwise or corner joints of extremely long bases and surrounds, lintels, banisters and frames, arched windows, worktops, corner benches, etc.
- Release lever blue dip-insulated
- Nickel-plated
- The workpieces to be glued are placed together, with the grip open, the drill holes for the clamping pins are marked, and 9 - 10 mm Ø holes drilled. Glue is applied, the wrench pushed into the holes, the pieces aligned and the clamping lever closed - the work is finished



Code	No.	mm	inch	mm	inch	mm	inch	mm	inch
6403600	137 T	220	9	30-60	1.1/4-2.1/2	494	1		



138

WELDER'S GRIP WRENCH

- For clamping strips and profile sections when welding
- Malleable cast iron jaws
- Nickel-plated
- Release lever dip-insulated



Code	No.	mm	inch	mm	inch	mm	inch
6407350	138	280	11	960	1		

138 X

WELDER'S GRIP WRENCH FOR TUBES

- For clamping tubes and round stock when welding
- Malleable cast iron jaws
- Nickel-plated
- Release lever dip-insulated



Code	No.	mm	inch	mm	inch	mm	inch
6407510	138 X	280	11	10-90	3/8-3.1/2	967	1

138 Y

PROFILE-SECTION GRIP WRENCH

- For clamping bulky profile and angle sections
- Strong forged jaws
- GEDORE chrome-vanadium steel, nickel-plated
- Release lever dip-insulated



Code	No.	mm	inch	mm	inch	mm	inch	mm	inch
6407860	138 Y	280	11	95	3.3/4	75	3	763	1

138 Z

PROFILE-SECTION GRIP WRENCH

- For clamping extremely bulky profile sections
- Jaws made from forged and welded GEDORE chrome-vanadium special steel
- Particularly great clamping depth
- Nickel-plated
- Release lever blue dip-insulated



Code	No.	mm	inch	mm	inch	mm	inch	mm	inch
6410730	138 Z-460	460	18	280	11	250	10	1164	1
6410810	138 Z-600	600	24	400	16	400	16	1428	1





8385

WIRE TWISTING PLIERS

- ▶ For twisting and cutting
- ▶ GEDORE special hardened and tempered steel, gun-metal finish
- ▶ Angled by 45°
- ▶ Extra narrow head shape
- ▶ Cross-hatched gripping face for better "wire grip"
- ▶ Twists wires from 0.5 to 1.6 mm Ø
- ▶ Clockwise or counterclockwise twisting, adjustable by turning handle
- ▶ Automatic resetting
- ▶ Cutting edge with FOD (= No Foreign Object Damage). The special red plastic coating securely holds the rest of the cut wire. This rules out the wire being accidentally lost.





Code	No.	(=mm=)	(="Inch=")		
1979957	8385	229	9	400	1

8386

CONNECTOR PLIERS

- ▶ With lap joint
- ▶ 3 settings
- ▶ Protects sensitive surfaces
- ▶ Particularly suitable for Canon-Connectors or other screw connectors
- ▶ Plastic jaws bolted and replaceable (No. E-8386), jaw width 11 mm
- ▶ GEDORE high-performance hardened and tempered steel, chrome-plated
- ▶ Handles dip-insulated



Code	No.	mm 		
2003481	8386	20-60	300	1
2003694	E-8386			1



PIPE WRENCHES

152

HIGH-SPEED PIPE WRENCH with screw adjuster

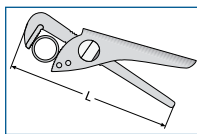
- ▶ GEDORIT powder-coated blue hammer finish
- ▶ Forged components
- ▶ Induction-rehardened serrated faces
- ▶ Quick and easy setting with screw adjuster - single-hand adjustment
- ▶ Gripping faces selfinhibiting







Code	No.	L	L"	mm 	"Inch 				
6419280	152 7	178	7	35	1.3/8	1"	3/4"	300	1
6419360	152 9	228	9	42	1.5/8	1.1/4"	1"	531	1
6419440	152 11	281	11	61	2.3/8	2"	1.3/4"	851	1
6419520	152 12	315	12	74	3	2.1/2"	2"	1038	1
6419600	152 14	360	14	90	3.9/16	3"	-	1656	1

152 G

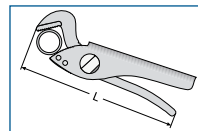
HIGH-SPEED PIPE WRENCH curved, with screw adjuster

- ▶ GEDORIT powder-coated blue hammer finish
- ▶ Forged components
- ▶ Induction-rehardened serrated faces
- ▶ Quick and easy setting with screw adjuster - single-hand adjustment
- ▶ Gripping faces selfinhibiting







Code	No.	L	L"	mm 	"Inch 	Pipes	Sockets		
1394835	152 G-7	175	7	35	1.3/8	1"	3/4"	273	1
1394843	152 G-9	225	9	42	1.5/8	1.1/4"	1"	556	1
1394851	152 G-12	300	12	74	3	2"	2"	1033	1

152 NI

HIGH-SPEED PIPE WRENCH NICKEL-PLATED with screw adjuster

- ▶ Nickel-plated
- ▶ Forged components
- ▶ Induction-rehardened serrated faces
- ▶ Quick and easy setting with screw adjuster - single-hand adjustment
- ▶ Gripping faces selfinhibiting



Code	No.	L	L"	mm 	"Inch 	Pipes	Sockets		
1826700	152 9 NI	228	9	42	1.5/8	1.1/4"	1"	520	1
1826727	152 12 NI	315	12	74	3	2.1/2"	2"	1000	1





BOLT CUTTERS

177

BOLT CUTTER

- Normal cutting, very robust and strong
- Cutters in high-carbon manganese-vanadium steel
- Induction hardened to Rockwell HRC 55-60
- With cam bolts for parallel adjustment of cutters
- Tensile strength 1125-1230 N/mm², handles in steel tubing - tough and light
- Cutting heads gun-metal finish, handles enamelled, with rubber hand-grips



Code	No.	mm	inch	Weight	Length
6438820	177 18	450	18	1550	1
6438900	177 24	600	24	2505	1
6439040	177 30	750	30	3940	1
6439120	177 36	900	36	6175	1
6439200	177 42	1050	42	8820	1

178

BOLT CUTTER SUPER

- Extra high cutting power, very robust and strong
- Cutters in high-carbon manganese-vanadium steel
- Induction hardened to Rockwell HRC 58-62
- With cam bolts for parallel adjustment of cutters
- Tensile strength 1125-1230 N/mm², tubular steel handles - tough and light
- Cutting heads and handles enamelled red, with rubber hand-grips



Code	No.	mm	inch	Weight	Length
6439470	178 18	450	18	1545	1
6439550	178 24	600	24	2520	1
6439630	178 30	750	30	3920	1
6439710	178 36	900	36	6015	1
6439980	178 42	1050	42	8905	1

9850

CUTTER FOR CONSTRUCTION STEEL MATS

- Knife and tube head in special steel, hot forged
- Adjustable by means of adjusting screw
- Max. cutting power in round stock, 9 mm or 2x 8 mm, 40 HRC
- Enamelled blue



Code	No.	mm	Weight	Length
4534390	985095	950	4,5	1



E 9850

PARTS



Code	No.	Description	Weight	Length
4624030	985109	Spare knife head	980	1
1468065	985809	Adjusting screw with 2 nuts	120	1
1912607	985500	Screw set	305	1

Maximum cutting power in mm

L Zoll	Maximum cutting power in mm											
	in round steel, hardness						in threaded bolts hardness phases tensile strength					
	145 HB 30 ≈ 490 N/mm ² tensile strength		230 HB 30 ≈ 765 N/mm ² tensile strength		385 HB 30 ≈ 1295 N/mm ² tensile strength		5,6 (5 D)		8,8 (8 D)		10,9 (10 K)	
No.	177	178	177	178	177	178	177	178	177	178	177	178
18"	7	8	6	7	5	6	7	8	6	7	5	6
24"	9	10	8	9	6,5	8	8	10	7	8	6	7
30"	10	12	9	10	8	9	10	12	8	10	7	8
36"	12	14	10	12	9	10	12	14	10	12	8	10
42"	14	16	11	14	10	11	14	16	12	14	10	12



920 · 922 · 923



487



WATER PUMP / UNIVERSAL PLIERS

i 142 Universal pliers



142

UNIVERSAL PLIERS

- ▶ Acc. to DIN ISO 8976 Form C
- ▶ With safety box joint and protection against blocking
- ▶ Fine adjustment
- ▶ 142 10 = 15 settings
- ▶ 142 12 = 17 settings
- ▶ Single-hand push-button adjustment
- ▶ Long slim jaws
- ▶ Version C = slim handles with forged serrations
- ▶ Version TL = clear varnished, with blue dipped handle protectors
- ▶ Version JC = chrome-plated, 2-component handles
- ▶ Offset gripping faces for self-gripping of nuts and pipes
- ▶ GEDORE chrome-vanadium special steel
- ▶ Induction-rehardened serrated faces

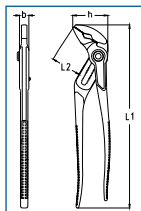

TL

Code	No.	L ₁	L ₂	b	h	mm	mm	mm
6416180	142 10 TL	255	39	7.5	48	38	371	5
6416260	142 10 C	250	39	7.5	48	38	380	5
6416340	142 10 JC	260	39	7.5	48	38	417	5
1995413	142 12 TL	309	43	8.5	55	44	550	1
1995553	142 12 C	300	43	8.5	55	44	530	1

143

UNIVERSAL PLIERS 5 settings

- ▶ Acc. to DIN ISO 8976 Form B
- ▶ Forged twin-groove lay-on slip joint and toothed recess
- ▶ Offset gripping faces for self-gripping of nuts and pipes
- ▶ With finger protection
- ▶ GEDORE chrome-vanadium special steel, chrome-plated
- ▶ Induction-rehardened serrated faces

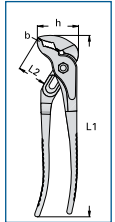

Code	No.	L ₁	L ₂	b	h	mm	mm	mm
6410650	143 10 C	248	40	10.6	56	32	412	5
6415880	143 10 JC	252	40	10.6	56	32	459	5

144

MECHANICS PLIERS 7 settings

- ▶ Acc. to DIN ISO 8976 Form A
- ▶ Lay-on slip joint and straight, serrated jaws
- ▶ GEDORE chrome-vanadium special steel
- ▶ Induction-rehardened serrated faces

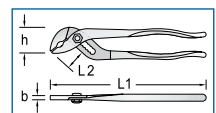

Code	No.	L ₁	L ₂	b	h	mm	mm	mm
6411110	144 4.1/2 C	113	13	3.8	23	16	42	1
6411380	144 7 C	175	22	5.5	35	26	138	1



i 145 Water pump pliers

Induction-hardened teeth
Clamps automatically on pipes
and nuts

Extremely slender pliers
head for places that are hard
to access

Tried-and-tested and
popular 7-fold setting

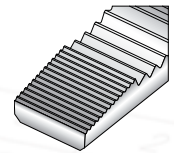

145

WATER PUMP PLIERS

- Acc. to DIN ISO 8976 Form A
- Lay-on slip joint and toothed recess
- Induction-rehardened serrated faces, with finger protection
- GEDORE chrome-vanadium special steel, chrome-plated
- Execution C = handles cross-hatched
- Execution JC = with 2-component handle sleeves
- 145 10 = 7 settings, with extra narrow jaws
- 145 15 = 9 settings
- 145 20 = 11 settings

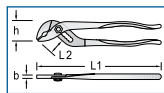

Code	No.	L ₁	L ₂	b	h	mm	mm	mm
6412000	145 10 C	250	41	7.8	47	39	365	5
6415610	145 10 JC	260	41	7.8	47	39	425	5
6412190	145 15 C	375	46	10.4	72	50	854	1
6412270	145 20 C	500	55	13.8	98	65	1747	1

146 B

SPECIAL WATER PUMP PLIERS 5 settings

- Acc. to DIN ISO 8976 Form C
- With fast adjustment and tooth-lock box joint and toothed aperture
- Absolutely safe - no slipping out of adjustment during work
- With finger protection
- GEDORE chrome-vanadium special steel, chrome-plated, polished



Code	No.	L ₁	L ₂	b	h	mm	mm	mm
6412510	146 B 10	250	45	8	55	50	485	1



146

UNIVERSAL PLIERS 7 settings

- Acc. to DIN ISO 8976 Form C
- With safety box joint and finger protection
- Automatic clamping with offset gripping surfaces
- GEDORE chrome-vanadium special steel, chrome-plated, with polished surface
- Induction-rehardened serrated faces

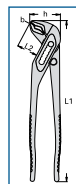

Code	No.	L ₁	L ₂	b	h	mm	mm	mm
6413240	146 10 CP	250	32.5	4.8	48	31	335	5

100



520



PLIER ASSORTMENTS



- ✔ Produced in-house by GEDORE Austria
- ✔ Combination, flat-nosed, round-nosed and mechanics pliers made from GEDORE special hardened and tempered steel
- ✔ Side cutters and end cutting nippers made from GEDORE high-performance hardened and tempered steel
- ✔ TL = black, with blue dipped handle protectors
- ✔ JC = chrome-plated, 2-component handles with secure-grip hand protection
- ✔ Hot-forged tempered steel
- ✔ Precision machined, oil-hardened and annealed
- ✔ Induction-rehardened cutting edges
- ✔ Protective nickel and chrome plating
- ✔ Optimum transfer of force
- ✔ High cutting performance
- ✔ Fatigue-free, even in constant use
- ✔ Guaranteed GEDORE quality

S 8003 JC

PLIERS SET 3 pieces

- ✔ Practical set composition in environmentally-friendly cardboard box
- ✔ JC = chrome-plated, 2-component handles with secure-grip hand protection





Code	No.	Contents		
6701110	S 8003 JC	8132-160 JC 8250-180 JC 8316-160 JC	766	1

S 8003 TL

PLIERS SET 3 pieces

- ✔ Practical set composition in environmentally-friendly cardboard box
- ✔ TL = clear varnished, with blue dipped handle protectors





Code	No.	Contents		
6755470	S 8003 TL	8132-160 TL 8250-180 TL 8316-160 TL	642	1

S 8200 JC

PLIERS SET 4 pieces

- ✔ Practical set composition in environmentally-friendly cardboard box
- ✔ JC = chrome-plated, 2-component handles with secure-grip hand protection





Code	No.	Contents		
6730800	S 8200 JC	8098-160 JC 8132-160 JC 8250-180 JC 8314-160 JC	927	1

S 8200 TL

PLIERS SET 4 pieces

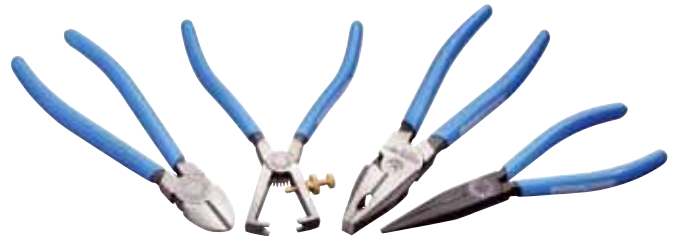
- ✔ Practical set composition in environmentally-friendly cardboard box
- ✔ TL = clear varnished, with blue dipped handle protectors



Code	No.	Contents		
6738700	S 8200 TL	8098-160 TL 8132-160 TL 8250-180 TL 8314-160 TL	754	1



**S 8303 JC****PLIERS SET 3 pieces**

- Practical set composition in environmentally-friendly cardboard box
- JC = chrome-plated, 2-component handles with secure-grip hand protection



Code	No.	Contents		
6703160	S 8303 JC	142 10 JC 8250-180 JC 8316-160 JC	1005	1

RZB1-2**PLIERS SET 6 pieces**

Code	No.	Contents		
1708155	RZB1-2	8098-160 JC 8120-160 JC 8122-160 JC 8132-160 JC 8250-180 JC 8316-180 JC	1740	1

S 8303 TL**PLIERS SET 3 pieces**

- Practical set composition in environmentally-friendly cardboard box
- TL = clear varnished, with blue dipped handle protectors



Code	No.	Contents		
6703910	S 8303 TL	142 10 TL 8250-180 TL 8316-160 TL	880	1

RZB1-1**PLIERS SET 6 pieces**

Code	No.	Contents		
1689312	RZB1-1	142 10 JC 8136-200 JC 8250-180 JC 8316-160 JC 8010 A 2 8010 J 2	2000	1

S 8004 TL**PLIERS SET 3 pieces**

- Practical set composition in environmentally-friendly cardboard box
- TL = clear varnished, with blue dipped handle protectors



Code	No.	Contents		
6752960	S 8004 TL	8132-160 TL 8245-180 TL 8316-160 TL	641	1

RZB2-12**PLIERS SET 3 pieces**

Code	No.	Contents		
1692305	RZB2-12	8132-160 JC 8250-180 JC 8316-160 JC	875	1



RZB1-10

PLIERS SET 4 pieces



Code	No.	Contents	📦	📅
1701290	RZB1-10	137 10 145 10 JC 8250-200 JC 247 H-35	2424	1

RZB1-15

PLIERS SET 4 pieces



Code	No.	Contents	📦	📅
1823264	RZB1-15	8098-160 JC 8132-160 JC 8250-180 JC 8314-160 JC	1320	1

RZB1-21

PLIERS SET 6 pieces



Code	No.	Contents	📦	📅
2159414	RZB1-21	142 10 TL 8133-180 TL 8000 A 2 A 22 8000 J 2 J 22	1683	1

RZB1-16

TOOL SET 6 pieces



Code	No.	Contents	📦	📅
1823671	RZB1-16	8250-180 JC 8316-160 JC 2150 4 6,5 2160 PH 1 2	1305	1

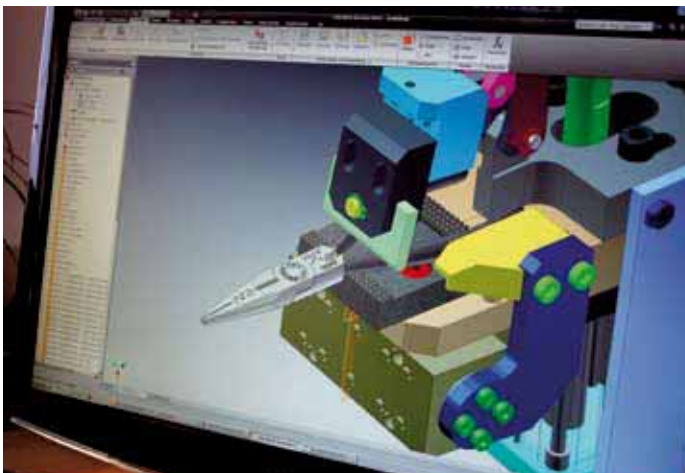

➔ **1500 ES-145 1500 CT1-8000**







CIRCLIP PLIERS SETS

S 8000

SET OF CIRCLIP PLIERS 4 pieces

- Most popular sizes, packed in environmentally-friendly cardboard box
- Particularly suitable for barely accessible places
- For internal and external circlip rings
- With straight and 90° angled tips



Code	No.	Contents	Weight	Units
6701030	S 8000	8000 A 2 A 21 8000 J 2 J 21	756	1



S 8008

SET OF CIRCLIP PLIERS 8 pieces

- Most popular sizes, packed in environmentally-friendly cardboard box
- Particularly suitable for barely accessible places
- For internal and external circlip rings
- With straight and 90° angled tips

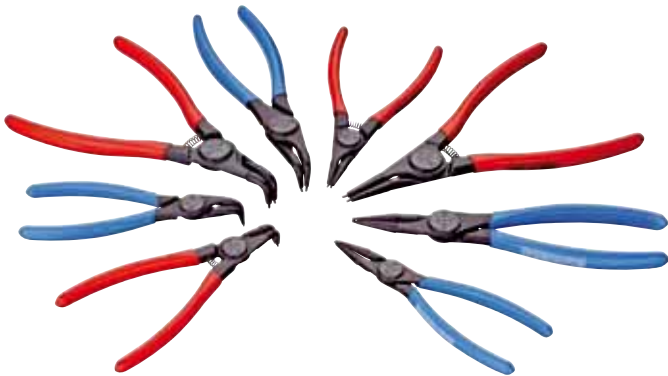

Code	No.	Contents	Weight	Units
6700490	S 8008	8000 A 1 A 11 A 2 A 21 8000 J 1 J 11 J 2 J 21	1082	1

S 8010

SET OF CIRCLIP PLIERS 4 pieces

- Most popular sizes, packed in environmentally-friendly cardboard box
- Particularly suitable for barely accessible places
- For internal and external circlip rings
- With straight and 90° angled tips



Code	No.	Contents	Weight	Units
6702000	S 8010	8010 A 2 A 21 8010 J 2 J 21	760	1

S 8024

SET OF CIRCLIP PLIERS 4 pieces

- Most popular sizes, packed in environmentally-friendly cardboard box
- For automotive use
- Particularly suitable for barely accessible places
- For internal and external circlip rings
- With straight and 45° angled tips



Code	No.	Contents	Weight	Units
2148684	S 8024	8000 A 2 A 22 8000 J 2 J 22	756	1

→ 920-922 • 923



487



S 8100

SET OF CIRCLIP PLIERS 4 pieces

- Most popular sizes, packed in environmentally-friendly cardboard box
- Particularly suitable for barely accessible places
- For internal and external circlip rings
- With straight and 90° angled tips



Code	No.	Contents	5	6
6703080	S 8100	8000 A 1 A 2 8000 J 1 J 2	597	1

S 8028

SET OF CIRCLIP PLIERS 8 pieces

- Most popular sizes, packed in environmentally-friendly cardboard box
- For automotive use
- Particularly suitable for barely accessible places
- For internal and external circlip rings
- With straight and 45° angled tips

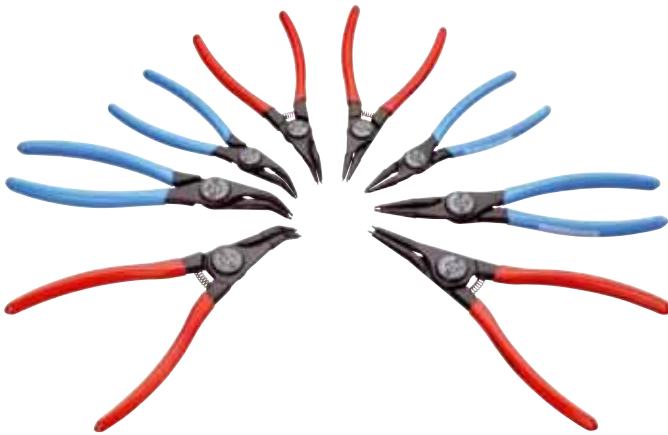

Code	No.	Contents	5	6
2148692	S 8028	8000 A 1 A 2 A 12 A 22 8000 J 1 J 2 J 12 J 22	1082	1

RZB1-3

PLIERS SET 8 pieces

- Usual type of tool set packed in sturdy plastic case
- Particularly suitable for barely accessible places
- For internal and external circlip rings
- With straight and 90° angled tips



Code	No.	Contents	5	6
1692275	RZB1-3	8000 A 1 A 11 A 2 A 21 8000 J 1 J 11 J 2 J 21	1550	1

RZB1-11

PLIERS SET 4 pieces

- Usual type of tool set packed in sturdy plastic case
- Particularly suitable for barely accessible places
- For internal and external circlip rings
- With straight and 90° angled tips



Code	No.	Contents	5	6
1692283	RZB1-11	8000 A 2 A 21 8000 J 2 J 21	1155	1





RZB1-19

SET OF CIRCLIP PLIERS 8 pieces

- For automotive use
- Particularly suitable for barely accessible places
- Circlip pliers with straight and 45° angled tips
- For the safe installation and removal of internal and external retaining rings up to a size of 60 mm
- In rugged plastic case



Code	No.	Contents		
2148706	RZB1-19	8000 A 1 A 12 A 2 A 22 8000 J 1 J 12 J 2 J 22	1550	1

RZB1-20

SET OF CIRCLIP PLIERS 4 pieces

- For automotive use
- Particularly suitable for barely accessible places
- Circlip pliers with straight and 45° angled tips
- For the safe installation and removal of internal and external retaining rings up to a size of 60 mm
- In rugged plastic case



Code	No.	Contents		
2155168	RZB1-20	8000 A 2 A 22 8000 J 2 J 22	1155	1



VDE insulated safety tools are listed up from page



501



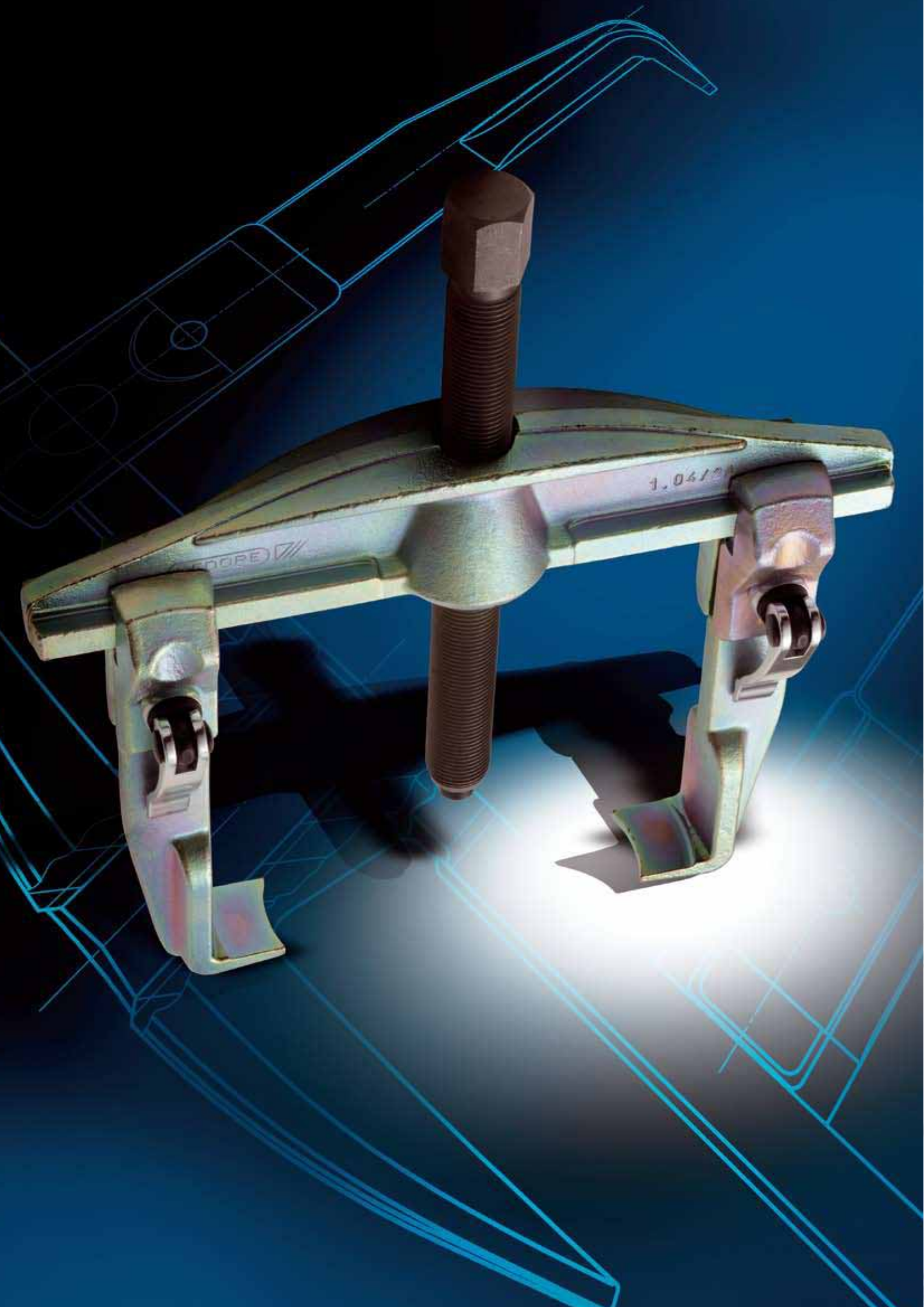



++ POWERFUL PULLING +



SERVICE / FEATURES

360 - 363

2-/3-ARM UNIVERSAL EXTERNAL + INTERNAL PULLERS



364 - 375

SUMMARY OF PULLER LEGS



376 - 377 SPINDLE SUMMARY



378

SAFETY COVER



379

BEARING ASSEMBLY



379

3-ARM EXTERNAL PULLER TWIST + PULL



380



2-/3-ARM FAN / BATTERY-TERMINAL PULLERS



381 - 386

2-/3-ARM EXTERNAL PULLERS



385

PULLERS WITH CLAMPING YOKE



386

PULLERS WITH SLIM LEGS



387

HYDRAULIC IMPLEMENTS



388 - 389

SEPARATORS



390 - 391

BALL BEARING EXTRACTORS



392 - 393

INTERNAL EXTRACTORS



SUPPORT BRACE



IMPACT BEARING PULLER



394 - 398

CYLINDER LINER PULLER



397

SPECIAL AUTOMOTIVE TOOLS



399 - 403

THREADED INSERTS



NUT SPLITTERS



STUD EXTRACTOR



404 - 405

ADD-ON SYSTEMS



406 - 407

HEAVY-DUTY PULLERS

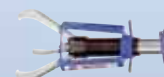

408 - 417

GEDORE PULLERS

FOR MAXIMUM PERFORMANCE -
EVEN UNDER A MULTI-TON LOAD

- High-grade industrial quality for the toughest forms of continuous use and safety in everyday work
- Our innovative force over the past few years, which has given rise to numerous patents and utility models, is very much a reflection of our extensive track record in the development and production of puller tools.
- Effortless moving of multi-ton loads
- Ideal for the controlled use of force and a vital requirement for safe working: puller in association with a torque wrench



BEST-POSSIBLE QUALITY FOR YOUR SAFETY

- Maximum value is attached to the safety of the puller when selecting the material and manufacturing process for each individual component part beforehand.
- Any overloading of drop-forged components, such as 2-arm cross-beams, legs and clamping parts, is revealed through deformation - on account of the course of their fibres - rather than through fracturing and/or splintering.
- Thermo-chemical treatment bestows a hardness on the components meeting the demands placed.
- Strict quality checks ensure a constant high level

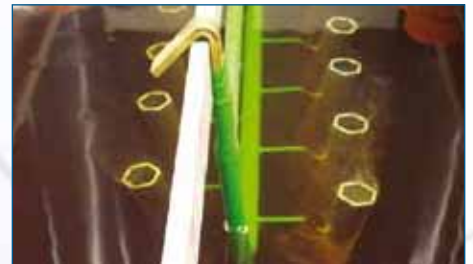

INTELLIGENT DESIGNS - WELL THOUGHT-OUT COMPONENTS

- The refined GEDORE pullers impress as much through their quality as they do through their user-friendliness and superiority in detail:
- A lasered scale on the 2-arm cross-beam enable the legs to be symmetrically aligned
- Leg brake and quick-release clamp are those rapid and assured ways of locking and fastening the puller legs
- Both the nitro-carburised mechanical and hydraulic spindles have properties that make work considerably easier and safer.

FLEXIBILITY AND SPECIALIZATION - THE RIGHT TOOL FOR EVERY DEMAND PLACED

- Irrespective as to whether the same pulling operations are repeated or whether you are confronted each time with new pulling challenges, special or flexible all-purpose pullers - saving both on time and force - are there to meet your individual demands
- The 1.06 and 1.07 series provide that unsurpassed flexibility. 2 and 3-arm cross-beams of various sizes, legs in the most varied of shapes and lengths, various fastening systems and the scope to replace the mechanical spindle by a hydraulic one all give rise to a modular system with which you can extensively retrofit and update your puller - thus making it applicable for all sorts of pulling situations.
- Appropriate ranges for varied fields of work - including the workshop, industry and agricultural/constructional machinery repairs.
- From the incidental parts to the heavy-duty puller, GEDORE provides tools for external, internal and ball bearing pullers and special-purpose tools. Should you still not find the right tool, then do contact us as to possible customized manufacturing.



THE PRODUCTION

MANUFACTURING PROCESS OF A 2-ARM 1.06 PULLER

In line with the requirement, we hot-form the ideal steel for each puller sub-assembly.



CROSS-BEAM

- Blank... from hard and tempered steel cut from the bar.
- "Pre-upsetting"... Mighty hammer blows drop-forme the cut-to-length forging into the hot "pre-form".
- Rough-forging... Powerful drop-hammer blows contour the cross-beam in the first die-sinking.
- Final forging... The cross-beam obtains its ultimate shape in the second die-sinking.
- De-burring... Excess burr is removed under an eccentric press.
- Forged blank... Ready for further processing and finishing.
- Calibrating... The width of the leg guide is calibrated and sand-blasted. Important for the following operations.
- Grinding... Grinding the cross-beam on all sides.
- Milling the leg guide... The height of the leg guide is milled to size.
- Drilling... Tapped hole is drilled.
- Cutting... The thread for the spindle is cut.
- Zinc-plating... Electro-galvanized for corrosion protection.
- Stamping... Manufacturer and Item No. are stamped on in a permanent fashion.
- Lasering... The check-tool marking is lasered.

CLAMPING PARTS

- Blank .. made of hard and tempered steel and cut to size from the bar.
- Upsetting... Mighty hammer blows drop-forme the cut-to-length forging into the hot "pre-form".
- Rough-forging... Powerful drop-hammer blows contour the clamping parts in the first die-sinking.
- Final forging... The clamping parts obtain their ultimate shape in the second die-sinking.
- Hot de-burring... Still hot excess burr is removed under an eccentric press.
- Forged blank... Ready for further processing and finishing.
- Calibrating... The clamping part is calibrated and sand-blasted.
- Perforating... The two holes for connection with the leg are cold-holed.
- Zinc-plating... Electro-galvanizing protects the clamping part from corrosion.
- Mounting... A pin and a screw and/or the quick-release clamp are for connecting two clamping parts to the leg.

LEGS

- Blank .. made of 31CrV3 and cut to size from the bar.
- Forging... hot, drop-forged.
- De-burring... Excess burr is removed under an eccentric press.
- Calibrating... The leg is calibrated and sand-blasted.
- Drilling... The holes for the clamps are drilled.
- Milling... Milling provides the leg base with its optimum form.
- Tempering... A special thermal treatment involving inert gas gives the leg its extreme hardness and toughness. Hardening ensures the required hardness and the annealing which follows imparts that toughness to the legs. Hardening and annealing together are referred to as tempering.
- Sand-blasting... Sand-blasting is made use of to clean the surface before processing continues.
- Zinc-plating... Electro-galvanizing protects the leg from corrosion.
- Pressing-in... The connecting pin for the two clamping parts is pressed in.

SPINDLE

- Blank ... from hard and tempered steel cut from the bar.
- Turning + drilling... Turn the spindle to measure and the drill hole for the spindle tip is inserted.
- Rolling... The fine thread is rolled.
- Nitro-carburating... Edge-layer hardening of the thread. The spindle is toughened at the edge and thus resistant to wear. The core remains "soft" and flexible and resiliently absorbs any stresses arising.
- Riveting... Either the firm spindle tip is permanently riveted or the replaceable spindle tip inserted.



YOUR PATH TO THE RIGHT PULLER



- + HOW CAN THE COMPONENT TO BE EXTRACTED BE GRIPPED?
- + IS A SUPPORT POSSIBLE EITHER EXTERNALLY OR INTERNALLY?
- + WHICH CLAMPING SPREAD/REACH HAS TO BE OBTAINED?

EXTERNAL PULLING

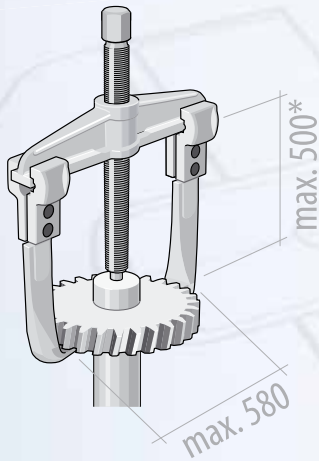

- ▣ The component to be extracted can only be gripped externally
- ▣ The centre axle is for supporting purposes

364 - 389

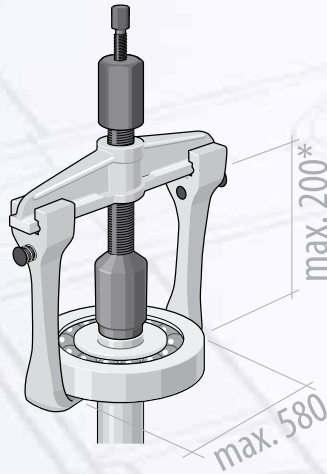

- ▣ The component to be extracted is well set into, thus ruling out the use of pulling legs
- ▣ The centre axle is for supporting purposes

390 - 391

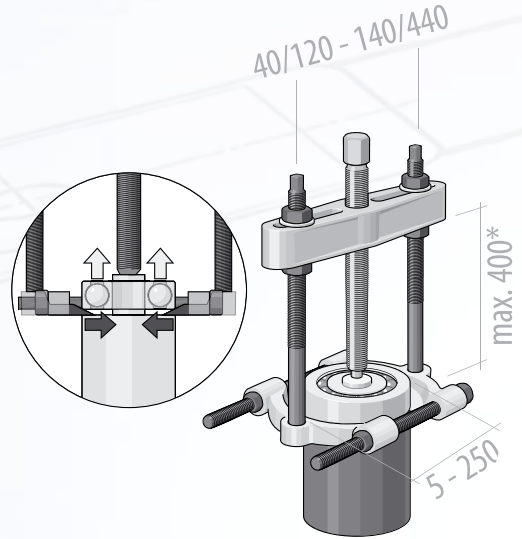

+ INTERNAL PULLING

- ▣ The component to be extracted can only be gripped internally
- ▣ Centre axle supporting is not possible

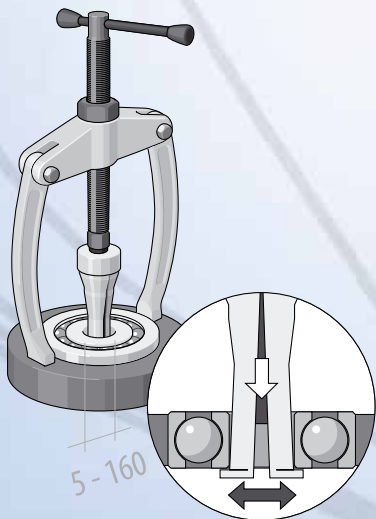

- ▣ Supporting possible outside of the component

394 - 398

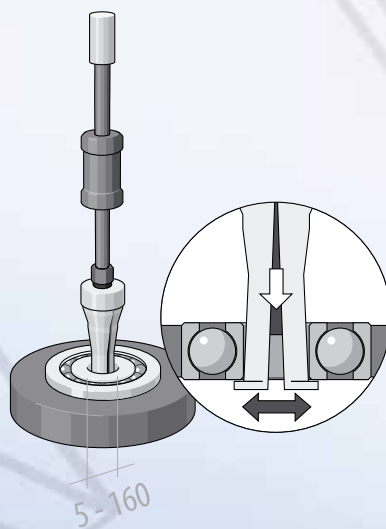

- ▣ No support possible - thus the use of extracting aids

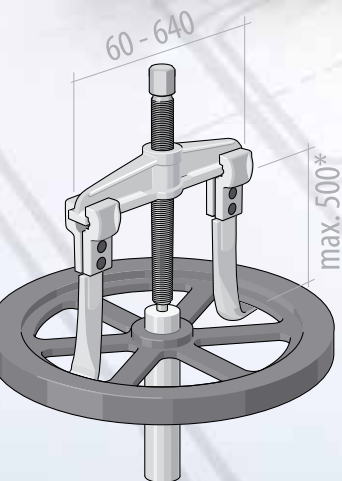

- ▣ Centre axle supporting is possible

368 - 373

* extendable using extensions



+ EXTRACTION USING A SPECIAL-PURPOSE TOOL

Automotive tool for

- ▣ Ball joints
- ▣ Oil filters / cartridges
- ▣ Steering wheel
- ▣ Springs
- ▣ Wheel hubs etc.

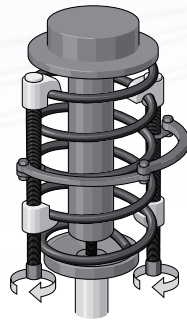
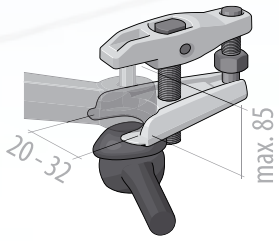

- ▣ Nut splitters
- ▣ Stud extractors

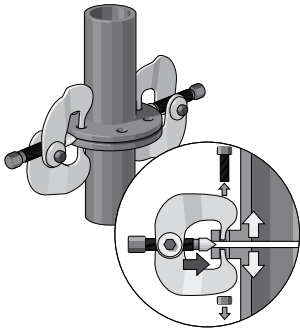

- ▣ Flange separators
- ▣ Threaded inserts

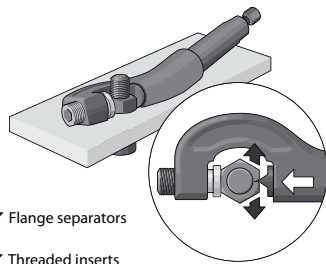

399 - 405

+ BALL BEARING EXTRACTION

▣ The ball bearing to be pulled is fitted on a shaft and in a housing and, as such, can neither be internally or externally gripped

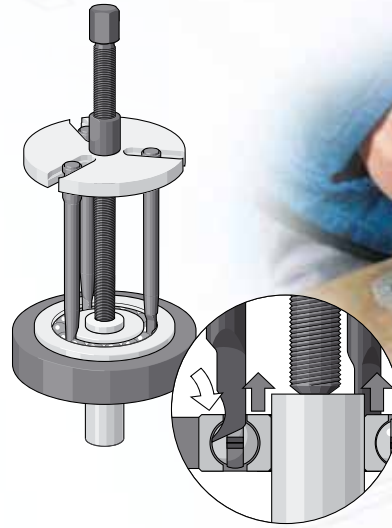

392 - 393

+ HEAVY-DUTY EXTRACTING

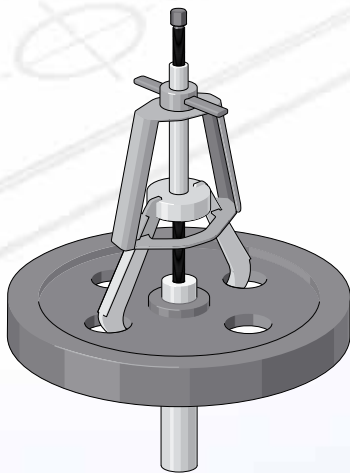

▣ Mechanical extracting of heavy loads up to 36 tons

408 - 409

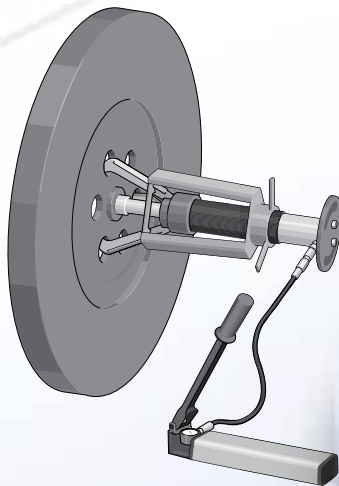

▣ Hydraulic extracting of heavy loads up to 45 tons

410 - 415

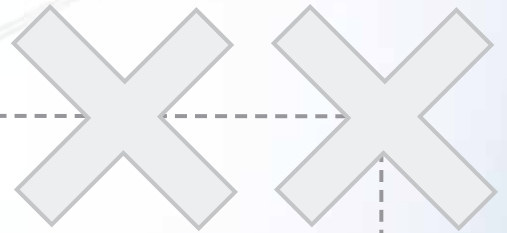

1.04 PULLER CONCENTRATED POWER FORGED FROM STEEL ----- ++

A THOROUGHLY SUPERIOR TYPE OF PULLER

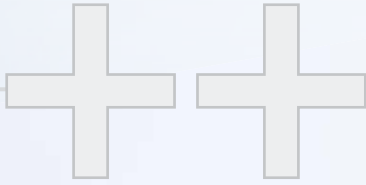

The legs of the 1.04 puller series have a T-profile. This ensures a positive fit between leg and cross-beam. The T-profile transfers the tensile force of the hooks via the clamping parts to the cross-beam - with no losses involved. The quick-release adjuster makes for trouble-free setting and readjustment

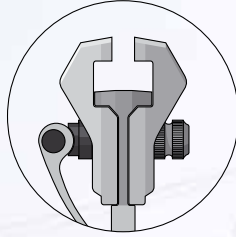

Reinforced cross-beam - the additional arching at the top of the crossbar produces an H-profile which, in turn, raises the load capacity as against the flexural torque.

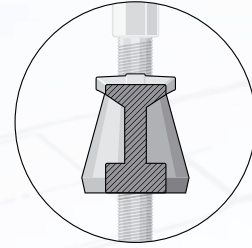

The permanently lasered scale makes it easier to symmetrically align the legs. This effectively stops any tilting when extracting caused by incorrectly positioned legs. A final marking specifies the maximum clamping spread.

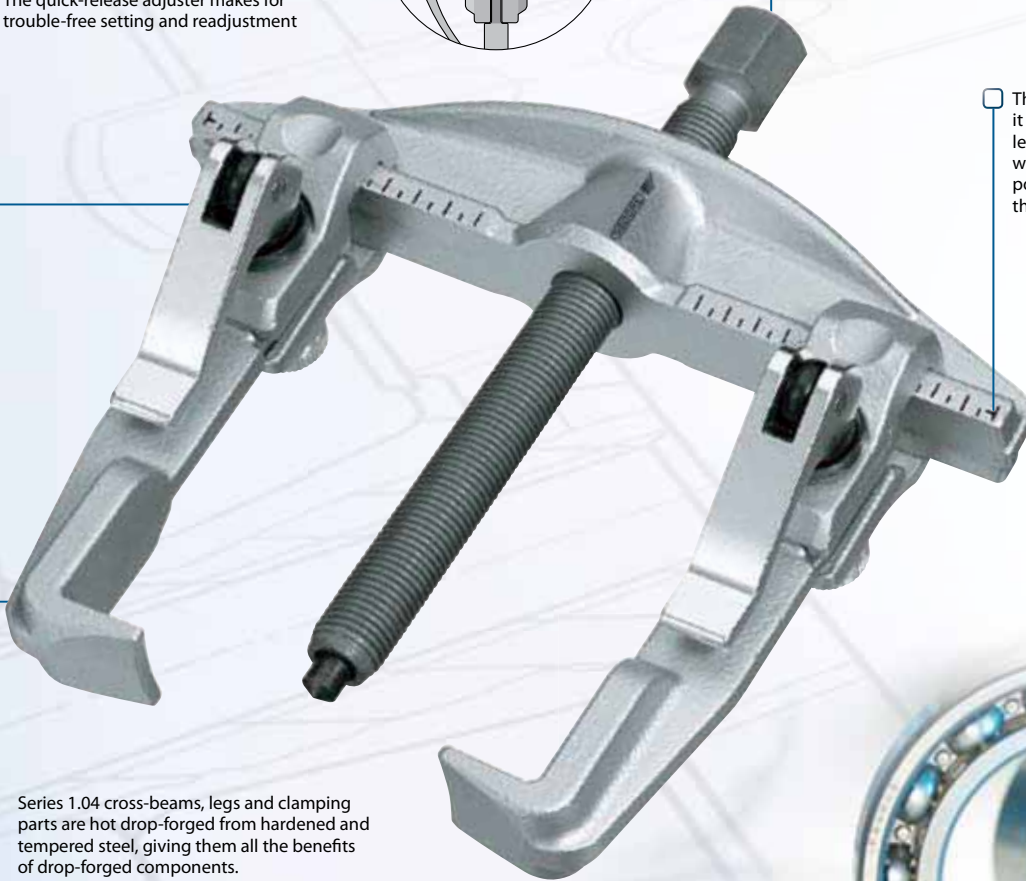
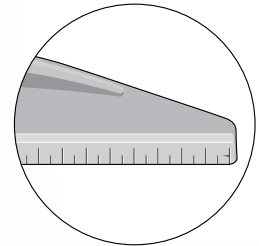

Series 1.04 cross-beams, legs and clamping parts are hot drop-forged from hardened and tempered steel, giving them all the benefits of drop-forged components.



SAFETY-RELEVANT

Forces amounting to several tons in weight act on the puller during the extracting operation! Drop-forged components "announce" possible overloading by bending. This is due to the fibre course of the material during forging permitting a certain flexibility of the components ahead of fracturing - an extremely "healthy" property, in fact !



GEDORE SPINDLES...

...comprise turned hardened and tempered steel. The fine thread is then rolled - this additional strengthening of the steel gives rolled thread a higher strength than a thread produced by cutting.

...have a fine thread which stops any unintended slackening from vibrations.

...are thermo-chemically treated. Nitro-carburating gives the spindle a high degree of wear and corrosion resistance. Oils and greases are not needed and, as such, the thread stays clean and smooth much longer.

...are fitted out with a replaceable spindle tip which is equally suitable for both centred and non-centred shafts.





1.04

UNIVERSAL PULLER 2-arm pattern

- For the safe and quick removal of pulleys, wheels, ball bearings, etc.
- Due to the bending-moment reinforcement on its back face, the energy-saving design of the cross-beam means even stronger and safer pulling work
- Scale for uniform adjustment of the puller legs. Allows centred pulling, with optimised application of force, even when extremely high pulling forces are required
- With the newly-developed cantilever hook design, it is possible to use these higher forces without losses over the whole width of the cross-beam
- The quick-action adjustment feature supports the energy-saving and fast operation
- Spindle with replaceable ball and tip point
- Upgradeable with hydraulic spindle (see table)

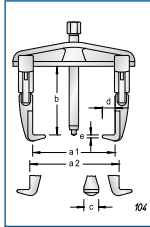
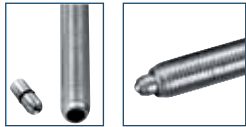

Code	No.	a ₁	a _{2 min}	a _{2 max}	b	Spindle	Tip	mm	c	d	e	max. t	Load	Wt
1307703	1.04/1A	130	70	170	100	M 14x1,5 x 140		17	22	12	3.0	3.0	x	1.2
1307827	1.04/2A	200	110	260	150	G 1/2 x 210	1.06/HSP1	22	30	18	3.5	5.0	x	3.4
1307940	1.04/3A	350	150	420	200	G 3/4 x 280	1.06/HSP2	27	36	28	6.5	7.5	x	7.7

1.04/B

UNIVERSAL PULLER 2-arm pattern, rigid legs with leg brake

- Due to the bending-moment reinforcement on its back face, the energy-saving design of the cross-beam means even stronger and safer pulling work
- Rigid legs forged from one piece
- The legs clamp automatically when under tension
- Leg brake - prevents unintentional leg slipping. The leg can be slid along the cross-beam at the push of a button
- By reversing the legs, this tool can be used as an internal or external puller
- Scale for uniform adjustment of the puller legs. Allows centred pulling, with optimised application of force, even when extremely high pulling forces are required
- Spindle with replaceable ball and tip
- Spindle thermo-chemically hardened
- Upgradeable with hydraulic spindle (see table)

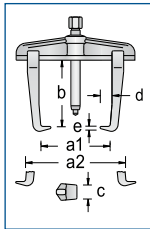
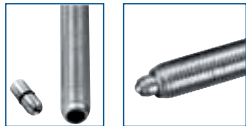

Code	No.	a ₁	a _{2 min}	a _{2 max}	b	Spindle	Tip	mm	c	d	e	max. t	Load	Wt
1981110	1.04/1A-B	130	70	170	100	M 14x1,5 x 140		17	22	15	3.0	3.0	x	1.2
1981129	1.04/2A-B	200	110	260	150	G 1/2 x 210	1.06/HSP1	22	30	24	3.5	5.0	x	3.4
1981137	1.04/3A-B	350	150	420	200	G 3/4 x 280	1.06/HSP2	27	36	33	5.0	7.5	x	7.7



LEGS WITH LEG BRAKE



376
-
377

104/E

QUICK-RELEASE PULLING LEG

- Quick-release pulling leg for 1.04



Code	No.	Part	b	c	d	e	Wt
1499351	104/A-100-TE	1.04/1A	100	22	12	3.0	0.3
1499378	104/B-150-TE	1.04/2A	150	30	18	3.5	0.7
1499386	104/C-200-TE	1.04/3A	200	36	28	6.5	2.9

1.04/ST

PULLER SET on sales display

- Consisting of 3 each pullers and sales display



Code	No.	Part	Wt
1675982	1.04/ST	1.04/1A 1.04/2A 1.04/3A	15.2
2300044	1.04/ST-HP-B	1.04/HP1A-B 1.04/HP2A-B 1.04/HP3A-B	15.2

1.04 HIGH POWER - THE POWER PACK

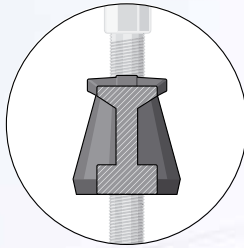

Reinforced cross-beam - the additional arching at the top of the crossbar produces an H-profile which, in turn, raises the load capacity as against the flexural torque. In the HP version the cross-beam is additionally hardened and tempered. This brings about practically a doubling of the loading limit!

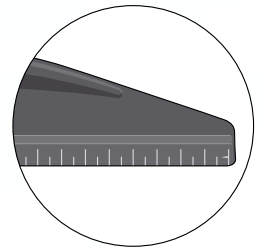

The permanently lasered scale makes it easier to symmetrically align the legs. This effectively stops any tilting when extracting caused by incorrectly positioned legs. A final marking specifies the maximum clamping spread.

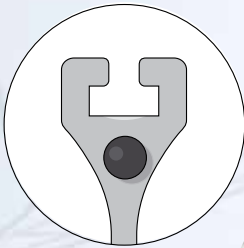

The all-in steel legs are hot forged in one piece from 31CrV3 steel and hardened/tempered. They provide a positive-locking connection to the cross-beam. The leg brake secures the hooks from unintentional motions. Pressing the release button unlatches the locking - the leg can be moved on the cross-beam. Releasing the button causes the leg to jam tight on the cross-beam with slipping ruled out.



SAFETY-RELEVANT

Forces amounting to several tons in weight act on the puller during the extracting operation! Drop-forged components "announce" possible overloading by bending. This is due to the fibre course of the material during forging permitting a certain flexibility of the components ahead of fracturing - an extremely "healthy" property, in fact !



HYDRAULIC SPINDLES

- ▶ Hydraulic spindles simplify the work - less force and time needed for a pulling operation
- ▶ The hydraulic spindle principle is both straightforward and ingenious at the same time. The effect of screwing in the clamping bolt is to compress the grease inside the hydraulic piston - the extending piston acts on the part to be extracted with a force many times greater than that manually applied at the top.
- ▶ This controlled operation provides for working safely with the hydraulic spindle and is recommended, in particular, for high levels of force.
- ▶ In the 1.04 series a hydraulic spindle can be used upwards of puller size 2A. The precise operation is gone into on Page 378.

**1.04/HP****UNIVERSAL PULLER HIGH POWER 2-arm pattern**

- Cross-beam especially hardened and tempered allows safe application of extremely high pulling forces and doubles the tensile force capability
- By reversing the legs, this tool can be used as an internal or external puller
- Scale for uniform adjustment of the puller legs. Allows centred pulling, with optimised application of force, even when extremely high pulling forces are required
- Integral legs, with quick-release
- Spindle with replaceable ball and tip
- Spindle thermo-chemically hardened
- Upgradeable with hydraulic spindle (see table)

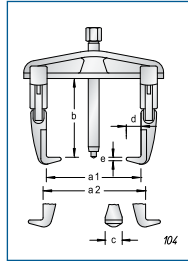
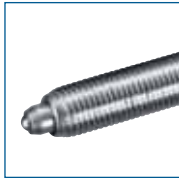

Code	No.	a ₁	a _{2 min}	a _{2 max}	b	—	—	● mm	c	d	e	max. t	—	—
1868152	1.04/HP1A	130	70	170	100	M 14x1,5 x 140		17	22	12	3.0	5.0	x	1.2
1868160	1.04/HP2A	200	110	260	150	G 1/2 x 210	1.06/HSP1	22	30	18	3.5	10.0	x	3.4
1868179	1.04/HP3A	350	150	420	200	G 3/4 x 280	1.06/HSP2	27	36	28	6.5	15.0	x	7.7

1.04/HP-B**UNIVERSAL PULLER HIGH POWER 2-arm pattern, rigid legs with leg brake**

- Cross-beam especially hardened and tempered allows safe application of extremely high pulling forces and doubles the tensile force capability
- Rigid legs forged from one piece
- Leg brake - prevents unintentional leg slipping. The leg can be slid along the cross-beam at the push of a button
- By reversing the legs, this tool can be used as an internal or external puller
- Scale for uniform adjustment of the puller legs. Allows centred pulling, with optimised application of force, even when extremely high pulling forces are required
- Two versions: with mechanical or hydraulic spindle

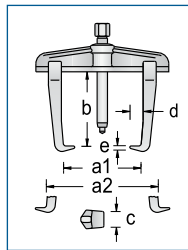

Code	No.	a ₁	a _{2 min}	a _{2 max}	b	—	—	● mm	c	d	e	max. t	—	—
1981145	1.04/HP1A-B	130	70	170	100	M 14x1,5 x 140		17	22	15	3.0	5.0	x	1.2
1981153	1.04/HP2A-B	200	110	260	150	G 1/2 x 210	1.06/HSP1	22	30	24	3.5	10.0	x	3.4
1981161	1.04/HP3A-B	350	150	420	200	G 3/4 x 280	1.06/HSP2	27	36	32	5.0	15.0	x	7.7

1.04/HP-B-HSP**UNIVERSAL PULLER HIGH POWER hydraulic, 2-arm pattern, solid steel legs with leg brake**

- Cross-beam especially hardened and tempered allows safe application of extremely high pulling forces and doubles the tensile force capability
- Rigid legs forged from one piece
- Leg brake - prevents unintentional leg slipping. The leg can be slid along the cross-beam at the push of a button
- By reversing the legs, this tool can be used as an internal or external puller
- Scale for uniform adjustment of the puller legs. Allows centred pulling, with optimised application of force, even when extremely high pulling forces are required
- With the hydraulic spindle, a controlled and safe pulling action is possible at all times

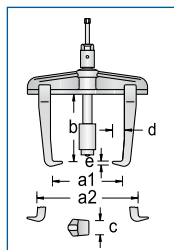

Code	No.	a ₁	a _{2 min}	a _{2 max}	b	—	—	c	d	e	max. t	max. N.m	—	—
2016206	1.04/HP2A-B-HSP1	200	110	260	150	1.06/HSP1		30	24	3.5	10.0	17	x	
2300036	1.04/HP3A-B-HSP2	350	150	420	200	1.06/HSP2		36	32	5.0	12.0	19	x	



1.06

UNIVERSAL PULLER 2-arm pattern

- The tried and tested model for the safe and quick removal of pulleys, wheels, ball bearings, etc.
- Strong drop forged design
- Scale for uniform adjustment of the puller legs. Allows centred pulling, with optimised application of force, even when extremely high pulling forces are required
- By reversing the legs, this tool can be used as an internal or external puller
- Extra or replacement legs increase versatility
- Upgradeable with hydraulic spindle (see table)

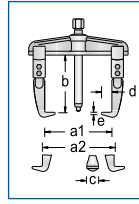

Code	No.	a ₁	a _{2 min}	a _{2 max}	b			● mm	c	d	e	max. t	سلسله	تعداد
8000230	1.06/1	90	60	140	100	M 14x1,5 x 140		17	22	12	3.0	3.0	x	1.1
8000310	1.06/1A	130	70	180	100	M 14x1,5 x 140		17	22	12	3.0	3.0	x	1.3
8000580	1.06/2	160	80	220	150	G 1/2 x 210	1.06/HSP1	22	30	18	3.5	5.0	x	3.0
8000660	1.06/2A	200	90	260	150	G 1/2 x 210	1.06/HSP1	22	30	18	3.5	5.0	x	3.5
8000740	1.06/3	250	125	330	200	G 3/4 x 280	1.06/HSP2	27	36	28	6.5	7.5	x	7.2
8000820	1.06/3A	350	125	420	200	G 3/4 x 280	1.06/HSP2	27	36	28	6.5	7.5	x	8.2
8000900	1.06/4	520	185	600	200	G 1 x 310	1.06/HSP3	36	36	28	6.5	10.0	-	13.7

1.06

UNIVERSAL PULLER 2-arm pattern, with extended legs

- Strong drop forged design
- Scale for uniform adjustment of the puller legs. Allows centred pulling, with optimised application of force, even when extremely high pulling forces are required
- Extended legs
- By reversing the legs, this tool can be used as an internal or external puller
- Extra or replacement legs increase versatility
- Upgradeable with hydraulic spindle (see table)

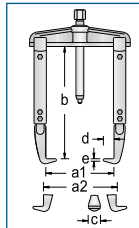

Code	No.	a ₁	a _{2 min}	a _{2 max}	b			● mm	c	d	e	max. t	سلسله	تعداد
8108350	1.06/1-2	90	60	140	200	M 14x1,5 x 140		17	22	12	3.0	3.0	x	1.5
8108430	1.06/1A-2	130	70	180	200	M 14x1,5 x 140		17	22	12	3.0	3.0	x	1.6
8108510	1.06/2-3	160	80	220	300	G 1/2 x 210	1.06/HSP1	22	30	18	3.5	5.0	x	4.1
8108780	1.06/2A-3	200	90	260	300	G 1/2 x 210	1.06/HSP1	22	30	18	3.5	5.0	x	4.5
8001200	1.06/3-3	250	125	330	300	G 3/4 x 280	1.06/HSP2	27	36	28	6.5	7.5	x	9.1
8108860	1.06/3A-3	350	125	420	300	G 3/4 x 280	1.06/HSP2	27	36	28	6.5	7.5	x	9.8
8108940	1.06/4-3	520	185	600	300	G 1 x 310	1.06/HSP3	36	36	28	6.5	10.0	x	15.2
8109080	1.06/3-4	250	125	330	400	G 3/4 x 280	1.06/HSP2	27	36	28	6.5	7.5	x	10.0
8109160	1.06/3A-4	350	125	420	400	G 3/4 x 280	1.06/HSP2	27	36	28	6.5	7.5	x	11.1
8109240	1.06/4-4	520	185	600	400	G 1 x 310	1.06/HSP3	36	36	28	6.5	10.0	-	16.4
8109320	1.06/3-5	250	125	330	500	G 3/4 x 280	1.06/HSP2	27	36	28	6.5	7.5	x	11.3
8112380	1.06/3A-5	350	125	420	500	G 3/4 x 280	1.06/HSP2	27	36	28	6.5	7.5	x	12.2
8112460	1.06/4-5	520	185	600	500	G 1 x 310	1.06/HSP3	36	36	28	6.5	10.0	-	19.0

1.06/B

UNIVERSAL PULLER 2-arm pattern, rigid legs with leg brake

- Strong drop forged design
- Rigid legs forged from one piece
- Leg brake - prevents unintentional leg slipping. The leg can be slid along the cross-beam at the push of a button
- Scale for uniform adjustment of the puller legs. Allows centred pulling, with optimised application of force, even when extremely high pulling forces are required
- By reversing the legs, this tool can be used as an internal or external puller
- Legs available in different lengths for special situations
- Upgradeable with hydraulic spindle (see table)

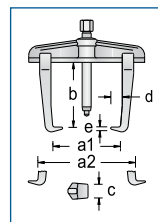

Code	No.	a ₁	a _{2 min}	a _{2 max}	b			● mm	c	d	e	max. t	سلسله	تعداد
1956337	1.06/11-B	100	50	140	100	M 14x1,5 x 140		17	22	15	3.0	3.0	x	0.9
1956345	1.06/1A1-B	140	60	180	100	M 14x1,5 x 140		17	22	15	3.0	3.0	x	1.3
1956353	1.06/21-B	170	80	220	150	G 1/2 x 210	1.06/HSP1	22	30	24	3.5	5.0	x	2.8
1956361	1.06/2A1-B	210	90	260	150	G 1/2 x 210	1.06/HSP1	22	30	24	3.5	5.0	x	3.3
1956388	1.06/31-B	250	125	340	200	G 3/4 x 280	1.06/HSP2	27	36	32	5.0	7.5	x	6.7
1956396	1.06/3A1-B	340	125	430	200	G 3/4 x 280	1.06/HSP2	27	36	32	5.0	7.5	x	7.5
1958399	1.06/41-B	520	185	610	200	G 1 x 310	1.06/HSP3	36	36	32	5.0	10.0	-	14.0

**1.06/E****QUICK-RELEASE PULLER 2-arm pattern**

- The tried and tested model for the safe and quick removal of pulleys, wheels, ball bearings, etc.
- Strong drop forged pattern
- Scale for uniform adjustment of the puller legs. Allows centred pulling, with optimised application of force, even when extremely high pulling forces are required
- By reversing the legs, this tool can be used as an internal or external puller
- Exchangeable legs for several clamping reaches available as accessories
- Quick release legs for fast, easy set-up and adjustment
- Upgradeable with hydraulic spindle (see table)

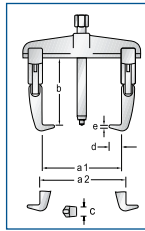

Code	No.	a ₁	a _{2,mm}	a _{2,max}	b	—	—	●mm	c	d	e	max. t	—	—
1213830	1.06/1-E	90	60	140	100	M 14x1,5 x 140		17	22	12	3.0	3.0	x	1.1
1215140	1.06/1A-E	130	70	180	100	M 14x1,5 x 140		17	22	12	3.0	3.0	x	1.3
1216570	1.06/2-E	160	80	220	150	G 1/2 x 210	1.06/HSP1	22	30	18	3.5	5.0	x	3.0
1217720	1.06/2A-E	200	90	260	150	G 1/2 x 210	1.06/HSP1	22	30	18	3.5	5.0	x	3.5
1218980	1.06/3-E	250	125	330	200	G 3/4 x 280	1.06/HSP2	27	36	28	6.5	7.5	x	7.1
1220160	1.06/3A-E	350	125	420	200	G 3/4 x 280	1.06/HSP2	27	36	28	6.5	7.5	x	8.2

1.06/S-E**QUICK-RELEASE PULLER 2-arm pattern, with slim legs**

- The forged leg feet are very slim
- Particularly suitable for barely accessible places
- Scale for uniform adjustment of the puller legs. Allows centred pulling, with optimised application of force, even when extremely high pulling forces are required
- Quick release legs for fast, easy set-up and adjustment

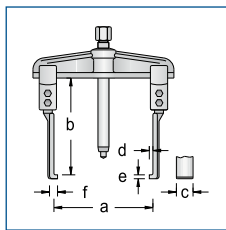
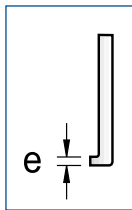

Code	No.	a	b	—	●mm	c	d	e	max. t	—	—
2015706	1.06/S1-E	100	100	M 14x1,5 x 140	17	27	7.5	3.7	2.0	x	1.0
2015714	1.06/S1A-E	140	100	M 14x1,5 x 140	17	27	7.5	3.7	2.5	x	1.1
2015722	1.06/S2-E	160	150	G 1/2 x 210	22	40	7.0	5.0	5.0	x	2.9
2015730	1.06/S2A-E	200	150	G 1/2 x 210	22	40	7.0	5.0	5.0	x	3.2

5.10

Remember the safety cover!



379

SPINDLE / LEGS



376 - 378

1.06/XS-E**QUICK-RELEASE PULLER 2-arm pattern, with XS legs**

- The forged leg feet are very slim
- Extra slim in width and depth
- Particularly suitable for barely accessible places
- Scale for uniform adjustment of the puller legs. Allows centred pulling, with optimised application of force, even when extremely high pulling forces are required
- Quick release legs for fast, easy set-up and adjustment

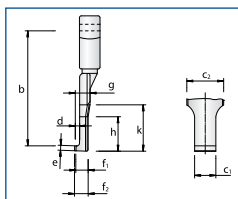
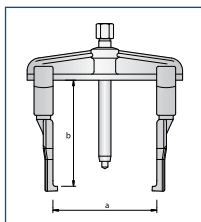

Code	No.	a	b	—	●mm	c ₁	c ₂	d	e	f ₁	f ₂	g	h	k	max. t	—	—
2018659	1.06/XS1-E	100	100	M 14x1,5 x 140	17	16.0	25	5.0	3.7	9.6	10.5	11.0	26.0	35.0	2.0	x	1.0
2018667	1.06/XS1A-E	140	100	M 14x1,5 x 140	17	16.0	25	5.0	3.7	9.6	10.5	11.0	26.0	35.0	2.0	x	1.1
2018675	1.06/XS2-E	160	150	G 1/2 x 210	22	17.5	32	5.5	3.5	11.0	11.5	13.5	25.5	38.5	3.5	x	2.9
2018683	1.06/XS2A-E	200	150	G 1/2 x 210	22	17.5	32	5.5	3.5	11.0	11.5	13.5	25.5	38.5	3.5	x	3.2



1.06/HSP

UNIVERSAL PULLER hydraulic, 2-arm pattern

- The tried and tested model for the safe and quick removal of pulleys, wheels, ball bearings, etc.
- Strong drop forged pattern
- Scale for uniform adjustment of the puller legs. Allows centred pulling, with optimised application of force, even when extremely high pulling forces are required
- By reversing the legs, this tool can be used as an internal or external puller
- With the hydraulic spindle, a controlled and safe pulling action is possible at all times

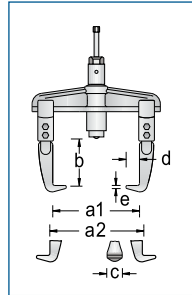

Code	No.	a ₁	a ₂	b	—	c	d	e	max. t	max. N.m	⚙️	🔄
8000150	1.06/2-HSP1	160	220	75	1.06/HSP1	30	18	3.5	5.0	9	x	3.6
8002870	1.06/2A-HSP1	200	260	75	1.06/HSP1	30	18	3.5	5.0	9	x	4.0
8003170	1.06/3-HSP2	250	330	125	1.06/HSP2	36	28	6.5	7.5	13	x	7.5
8003920	1.06/3A-HSP2	350	420	125	1.06/HSP2	36	28	6.5	7.5	13	x	8.8
8004060	1.06/4-HSP3	520	600	90	1.06/HSP3	36	28	6.5	10.0	25	-	14.6

1.06/HSP-B

UNIVERSAL PULLER hydraulic, 2-arm pattern, rigid legs with leg brake

- Strong drop forged pattern
- Scale for uniform adjustment of the puller legs. Allows centred pulling, with optimised application of force, even when extremely high pulling forces are required
- Rigid legs forged from one piece
- Leg brake - prevents unintentional leg slipping. The leg can be slid along the cross-beam at the push of a button
- By reversing the legs, this tool can be used as an internal or external puller
- With the hydraulic spindle, a controlled and safe pulling action is possible at all times

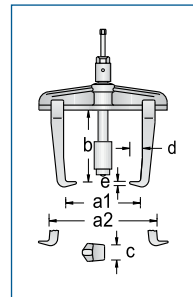

Code	No.	a ₁	a ₂	b	—	c	d	e	max. t	max. N.m	⚙️	🔄
1957899	1.06/21-B-HSP1	170	220	75	1.06/HSP1	30	24	3.5	5.0	9	x	3.3
1957902	1.06/2A1-B-HSP1	210	260	75	1.06/HSP1	30	24	3.5	5.0	9	x	3.4
1957910	1.06/31-B-HSP2	250	340	115	1.06/HSP2	36	32	5.0	7.5	13	x	7.2
1957929	1.06/3A1-B-HSP2	340	430	115	1.06/HSP2	36	32	5.0	7.5	13	x	8.3
1957937	1.06/41-B-HSP3	520	610	80	1.06/HSP3	36	32	5.0	10.0	25	-	14.0

1.06/AS

PULLER SET with 6 legs

- 2-arm puller, with 6 slim legs in 3 lengths
- Particularly suitable for barely accessible places

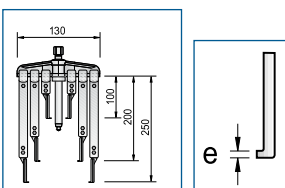
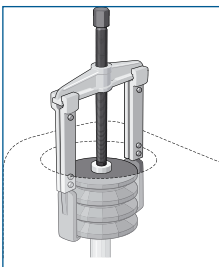

Code	No.	a	b	e	⚙️	🔄
8001710	1.06/AS	130	100 / 200 / 250	3.7	x	3.400
1675974	1.06/AS-2	200	150 / 220 / 300	5.0	x	8.060

1.06/ST

PULLER SET on display stand

- Consisting of 5 pullers each in different sizes with standard or quick-release pulling legs

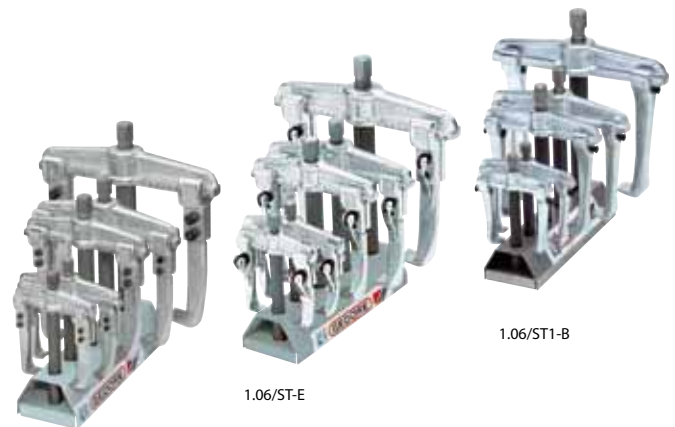

Code	No.	🔄	🔄
8111570	1.06/ST	1.06/1 1.06/1A 1.06/2 1.06/2A 1.06/3	19.0
2004569	1.06/ST1-B	1.06/11-B 1.06/1A1-B 1.06/21-B 1.06/2A1-B 1.06/31-B	17.2
1322745	1.06/ST-E	1.06/1-E 1.06/1A-E 1.06/2-E 1.06/2A-E 1.06/3-E	19.2



1.07

UNIVERSAL PULLER 3-arm pattern

- Even load distribution over 3 legs ensures secure grip and balanced pull
- By reversing the legs, this tool can be used as an internal or external puller
- Legs available in different lengths for special situations
- Upgradeable with hydraulic spindle (see table)

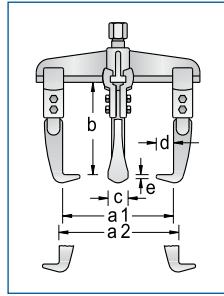

Code	No.	a ₁	a _{2 min}	a _{2 max}	b	⌀	mm	c	d	e	max. t	↔	
8113940	1.07/1	90	70	140	100	M 14x1,5 x 140	17	22	12	3.0	3.0	1.4	
8114080	1.07/1A	130	80	180	100	M 14x1,5 x 140	17	22	12	3.0	3.0	1.6	
8114160	1.07/2	160	100	220	150	G 1/2 x 210	1.06/HSP1	22	30	18	3.5	5.0	3.6
8114240	1.07/2A	200	100	260	150	G 1/2 x 210	1.06/HSP1	22	30	18	3.5	5.0	4.2
1541757	1.07/3	250	100	400	200	G 3/4 x 280	1.06/HSP2	27	36	28	6.5	7.5	9.3

1.07/4

UNIVERSAL PULLER 3-arm pattern

- Just like our standard model no. 1.06, this puller is designed for all branches of industry, but particularly for the construction of electric motors
- It is also suitable for removing heavy, multistage V-belt pulley wheels, flywheels, gear wheels, etc.
- Pins are used to lock the arms at 120 degrees to each other on the hub
- The clamping reach may be extended to 490 mm by using extensions no. 1.07/CV, 1.07/DV and 1.07/EV
- Upgradeable with hydraulic spindle (see table)
- This puller may also be used with the hydraulic aid 1.50 without requiring any reduction bushing
- Also available with further legs - please request

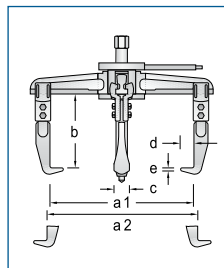

Code	No.	a ₁	a ₂	b	⌀	mm	c	d	e	max. t	↔	
8002440	1.07/4	450	530	200	G 1 x 360	1.06/HSP3	36	36	28	6.5	10	18.8
1958003	1.07/4A	580	640	200	G 1 x 360	1.06/HSP3	36	36	28	6.5	10	22.0
1305085	1.07/4-3	450	530	300	G 1 x 360	1.06/HSP3	36	36	28	6.5	10	21.0
1305271	1.07/4-4	450	530	400	G 1 x 360	1.06/HSP3	36	36	28	6.5	10	22.6
1305425	1.07/4-5	450	530	500	G 1 x 360	1.06/HSP3	36	36	28	6.5	10	25.2
2302799	1.07/4A-3	580	640	300	G 1 x 360	1.06/HSP3	36	36	28	6.5	10	24.2
2302802	1.07/4A-4	580	640	400	G 1 x 360	1.06/HSP3	36	36	28	6.5	10	25.8
2302810	1.07/4A-5	580	640	500	G 1 x 360	1.06/HSP3	36	36	28	6.5	10	28.4

1.07/B

UNIVERSAL PULLER 3-arm pattern, rigid legs with leg brake

- Even load distribution over 3 legs ensures secure grip and balanced pull
- Rigid legs forged from one piece
- Leg brake - prevents unintentional leg slipping. The leg can be slid along the cross-beam at the push of a button
- By reversing the legs, this tool can be used as an internal or external puller
- Legs available in different lengths for special situations
- Upgradeable with hydraulic spindle (see table)

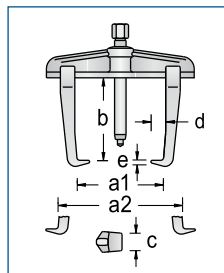

Code	No.	a ₁	a _{2 min}	a _{2 max}	b	⌀	mm	c	d	e	max. t	↔	
1957945	1.07/11-B	90	70	140	100	M 14x1,5 x 140	17	22	15	3.0	3.0	1.2	
1957953	1.07/1A1-B	130	80	180	100	M 14x1,5 x 140	17	22	15	3.0	3.0	1.4	
1957961	1.07/21-B	160	100	220	150	G 1/2 x 210	1.06/HSP1	22	30	24	3.5	5.0	3.5
1957988	1.07/2A1-B	200	100	260	150	G 1/2 x 210	1.06/HSP1	22	30	24	3.5	5.0	3.7
1957996	1.07/31-B	250	100	400	200	G 3/4 x 280	1.06/HSP2	27	36	28	6.5	7.5	8.0



1.07/E

QUICK-RELEASE PULLER 3-arm pattern

- Quick release legs for fast, easy set-up and adjustment
- By reversing the legs, this tool can be used as an internal or external puller
- Upgradeable with hydraulic spindle (see table)

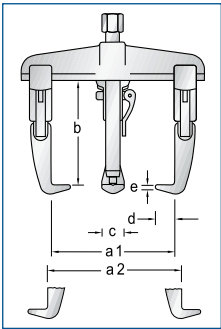

Code	No.	a ₁	a _{2 min}	a _{2 max}	b	⌀	mm	c	d	e	max. t	↕	
1222902	1.07/1-E	90	70	140	100	M 14x1,5 x 140	17	22	12	3.0	3.0	1.4	
1225901	1.07/1A-E	130	80	180	100	M 14x1,5 x 140	17	22	12	3.0	3.0	1.6	
1227335	1.07/2-E	160	100	220	150	G 1/2 x 210	1.06/HSP1	22	30	18	3.5	5.0	3.9
1227459	1.07/2A-E	200	100	260	150	G 1/2 x 210	1.06/HSP1	22	30	18	3.5	5.0	4.0
1554751	1.07/3-E	250	100	400	200	G 3/4 x 280	1.06/HSP2	27	36	28	6.5	7.5	9.2

1.07/S-E

QUICK-RELEASE PULLER 3-arm pattern, with slim legs

- The forged leg feet are very slim
- Particularly suitable for barely accessible places
- Quick release legs for fast, easy set-up and adjustment

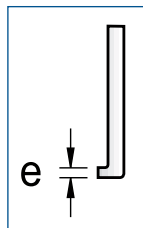
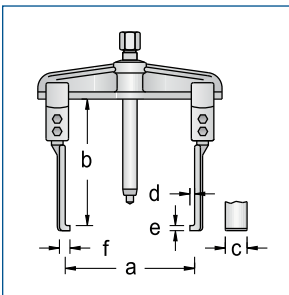

Code	No.	a	b	⌀	mm	c	d	e	max. t	↕
2016036	1.07/S1-E	90	100	M 14x1,5 x 140	17	27	7.5	3.7	2.5	1.3
2016044	1.07/S1A-E	130	100	M 14x1,5 x 140	17	27	7.5	3.7	2.5	1.4
2016052	1.07/S2-E	160	150	G 1/2 x 210	22	40	7.0	5.0	5.0	3.6
2016060	1.07/S2A-E	200	150	G 1/2 x 210	22	40	7.0	5.0	5.0	3.9



➔ **SPINDLE / LEGS**

376 - 378

➔ **920 • 923**

487

**1.07/XS-E****QUICK-RELEASE PULLER 3-arm pattern, with XS legs**

- The forged leg feet are very slim
- Extra slim in width and depth
- Particularly suitable for barely accessible places, e.g. gear maintenance
- Quick release legs for fast, easy set-up and adjustment

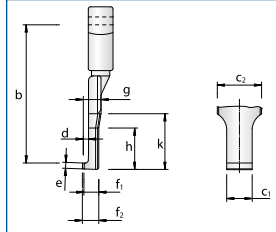
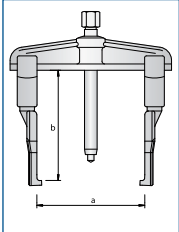

Code	No.	a	b	—	● mm	c ₁	c ₂	d	e	f ₁	f ₂	g	h	k	max. t	↕
2018829	1.07/XS1-E	90	100	M 14x1,5 x 140	16.0	16.0	25	5.0	3.7	9.6	10.5	11.0	26.0	35.0	3.0	1.3
2018837	1.07/XS1A-E	130	100	M 14x1,5 x 140	16.0	16.0	25	5.0	3.7	9.6	10.5	11.0	26.0	35.0	3.0	1.4
2018845	1.07/XS2-E	160	150	G 1/2 x 210	17.5	17.5	32	5.5	3.5	11.0	11.5	13.5	25.5	38.5	5.0	3.6
2018853	1.07/XS2A-E	200	150	G 1/2 x 210	17.5	17.5	32	5.5	3.5	11.0	11.5	13.5	25.5	38.5	5.0	3.9

1.07/HSP**UNIVERSAL PULLER hydraulic, 3-arm pattern**

- The tried and tested model for the safe and quick removal of pulleys, wheels, ball bearings, etc.
- Drop forged pattern
- By reversing the legs, this tool may be used as an internal or external puller
- With the hydraulic spindle, a controlled and safe pulling action is possible at all times

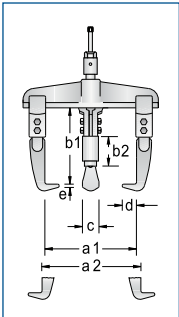

Code	No.	a ₁	a ₂	b	—	c	d	e	max. t	max. N·m	↕
8009960	1.07/2-HSP1	160	220	75	1.06/HSP1	30	18	3.5	5.0	9	4.6
8010970	1.07/2A-HSP1	200	260	75	1.06/HSP1	30	18	3.5	5.0	9	4.7
1554816	1.07/3-HSP2	250	310	80	1.06/HSP2	36	28	6.5	7.5	13	9.6
8012400	1.07/4-HSP3	450	530	140	1.06/HSP3	36	28	6.5	10.0	25	19.4
1962574	1.07/4A-HSP3	580	640	140	1.06/HSP3	36	28	6.5	10.0	25	22.4
2303019	1.07/4-3-HSP3	450	530	300	1.06/HSP3	36	28	6.5	10.0	25	21.6
2303027	1.07/4-4-HSP3	450	530	400	1.06/HSP3	36	28	6.5	10.0	25	23.2
2303035	1.07/4-5-HSP3	450	530	500	1.06/HSP3	36	28	6.5	10.0	25	25.8
2303043	1.07/4A-3-HSP3	580	640	300	1.06/HSP3	36	28	6.5	10.0	25	24.6
2303051	1.07/4A-4-HSP3	580	640	400	1.06/HSP3	36	28	6.5	10.0	25	26.2
2303078	1.07/4A-5-HSP3	580	640	500	1.06/HSP3	36	28	6.5	10.0	25	28.8

**5.10****Remember the safety cover!****379**



1.07/AS

PULLER SET with 9 legs

- 3-arm puller, with 9 slim legs in 3 lengths
- Particularly suitable for barely accessible places

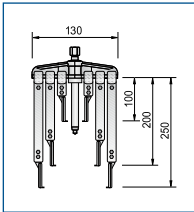
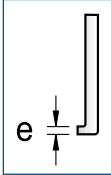

Code	No.	⌀	l ₁	e	l ₂
8117260	1.07/AS	130	100 / 200 / 250	3.7	4.8
1675990	1.07/AS-2	200	150 / 220 / 300	5.0	11.5



1.07/K-SE

PULLER SET with 3 legs

- In plastic case
- Contents: 1 spindle, 1 cross-beam each 2- and 3-arm pattern and 3 quick-release pulling legs
- Second spindle in the set 1.07/K-1-SE saves working time

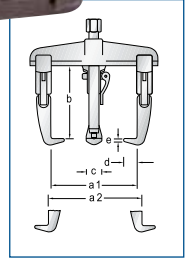
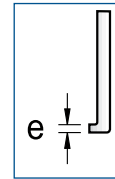

Code	No.	a ₁	b	⌀mm	●mm	c	d	e	l ₂
1438484	1.07/K-1-SE	90	100	M 14x1,5 x 140	17	27	7.5	3.7	2.2
1645455	1.07/K-2-SE	160	150	G 1/2 x 210	22	40	7.0	5.0	5.5

1.07/K

PULLER SET with 9 legs

- In plastic case
- Contents: 1 spindle, 1 cross-beam each 2- and 3-arm pattern and 9 slim pulling legs in 3 lengths
- Second spindle in the set 1.07/K saves working time

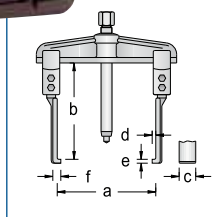
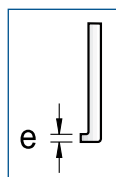

Code	No.	a	b	⌀mm	●mm	c	d	e	max. t	l ₂
8117340	1.07/K	130	100 / 200 / 250	M 14x1,5 x 140	17	27	7.5	3.7	2.5	5.8
1676008	1.07/K-2	200	150 / 220 / 300	G 1/2 x 210	22	40	7.0	5.0	5.0	13.5

➔ 1500 ES-1.07



89



**1.07/K-SE S****PULLER SET with 6 legs**

- In plastic case
- The forged leg feet are very slim particularly suitable for barely accessible places
- Quick release legs for fast, easy set-up and adjustment
- Contents: 2 spindles, 1 cross-beam each 2- and 3-arm pattern, and 6 slim quick-release pulling legs in 2 lengths
- Clamping reach 100 mm = thickness of hooked foot at tip (e) 3.7 mm
- Clamping reach 200 mm = thickness of hooked foot at tip (e) 2.0 mm

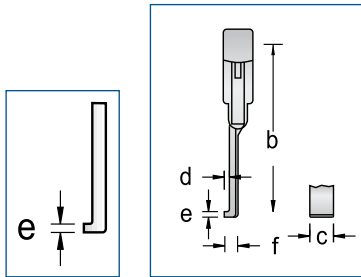

Code	No.	a	b	mm	mm	c	d	mm
1745158	1.07/K-1-SE 200 S	90	100 / 200	M 14x1,5 x 140	17	27	7.5	4.2

1.07/K-HSP**PULLER SET with 3 legs**

- For internal and external use, for hard, everyday use, for industrial use, or on cars and trucks
- In plastic case
- Contents: 1 hydraulic spindle, 1 cross-beam each 2- and 3-arm pattern and 3 quick-release pulling legs

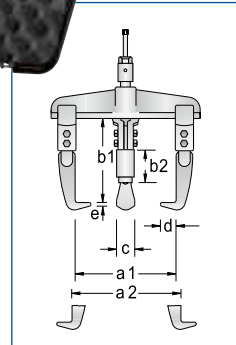

Code	No.	a ₁	a ₂	b	mm	c	d	e	max. t	N-m
1438492	1.07/K-2-E-HSP1	160	220	75	1.06 / HSP1	32	30	18	3.5	5.0

1.07/K-B**PULLER SET with 3 legs, with leg brake**

- In plastic case
- Contents: 2 spindles, 1 cross-beam each 2- and 3-arm pattern and 3 rigid legs with leg brake
- Prevents unintentional leg slipping. The leg can be slid along the cross-beam at the push of a button
- By reversing the legs, this tool can be used as an internal or external puller
- Extra spindle supplied for convenience



Code	No.	a	b	mm	mm	c	d	e
2224097	1.07/K-1A-B	140	100	M 14x1,5 x 140	17	22	15	3.0

**5.10****Remember the safety cover!****379**



106/XX-YY-ZZ xx = Leg size (A-C) yy = Leg length (in mm) zz = Leg type	for 3-arm puller
	for 2-arm puller
	Mechanical replacement spindle
	Hydraulic replacement spindle

1.06/1	1.06/1A
1.07/1	1.07/1A
1.1406140	

-N = The proven leg
1 leg incl. clamping parts with tried-and-tested screw connection in various lengths

Code	No.	b	c	d	e	⌀
1120514	106/A-100-N	100	22	12	3.0	0.6
1120522	106/A-200-N	200	22	12	3.0	

-B = The sturdy leg
1 leg with leg brake, secured against unintentional slipping, movement of the hook on the cross-beam at the touch of a button, forged from one piece

Code	No.	b	c	d	e	⌀
1970534	106/A-100-B	100	22	15	3.0	

-E = The quick use leg
1 leg incl. clamping parts with quick-release adjustment, for fast and uncomplicated setting and adjustment of the legs on the cross-beam

Code	No.	b	c	d	e	⌀
1178199	106/A-100-E	100	22	12	3.0	0.3

-SE = The slender leg
1 slim hook incl. clamping parts with quick-release adjustment, for fast and uncomplicated setting and adjustment of the legs on the cross-beam

Code	No.	b	c	d	e	⌀
1438514	106/A-100-SE	100	27	7.5	3.7	0.6
2015757	106/A-200-SE	200	27	7.5	3.7	
2015773	106/A-250-SE	250	27	7.5	3.7	
2015781	106/A-100-SSE	100	27	7.5	2.0	
2015811	106/A-200-SSE	200	27	7.5	2.0	
2015846	106/A-250-SSE	250	27	7.5	2.0	

-XSE = The sophisticated leg
As "The slender one" type but more slender in both width and depth for particularly cramped spaces and those places which can hardly be accessed e.g. in respect of gearbox maintenance

Code	No.	c ₁	c ₂	d	e	⌀
2018748	106/A-100-XSE	16.0	25	5.0	3.7	
2149222	106/A-200-XSE	16.0	25	5.0	3.7	
2150255	106/A-250-XSE	16.0	25	5.0	3.7	

-V = The flexi leg
The extension is inserted between cross-beam and leg and there is no limit on extending the clamping reach, forged from one piece.

Code	No.	b	⌀
1149016	106/A-100-V	100	0.4

The slim fit leg
1 slim leg for use in confined spaces
* Spare leg for "The slim one"
** Spare leg for "The filigree one"

Code	No.	c	d	e	f	⌀
1076957	106/S101*	27	7.5	3.7	14.5	450
1495607	106/S101-S*	27	7.5	2.0	14.5	110

Code	No.	c ₁	c ₂	d	e	⌀
2013681	106/XS101**	16.0	25	5.0	3.7	



1.06/2 1.06/2A

1.07/2 1.07/2A

1.2106210

1.06/HSP1

B

1.06/3 1.06/3A 1.06/4

1.07/3 1.07/4 1.07/4A

1.2606280

1.06/HSP2

C

1.3306310

1.06/HSP3

Code	No.	b	c	d	e	
1120530	106/B-150-N	150	30	18	3.5	0.7
1123947	106/B-300-N	300	30	18	3.5	1.3

Code	No.	b	c	d	e	
1120549	106/C-200-N	200	36	28	6.5	1.7
1120557	106/C-300-N	300	36	28	6.5	
1120565	106/C-400-N	400	36	28	6.5	
1120573	106/C-500-N	500	36	28	6.5	

Code	No.	b	c	d	e	
1970542	106/B-150-B	150	30	24	3.5	0.7

Code	No.	b	c	d	e	
1970550	106/C-200-B	200	36	32	5.0	

Code	No.	b	c	d	e	
1178253	106/B-150-E	150	22	12	3.0	0.3

Code	No.	b	c	d	e	
1178350	106/C-200-E	200	36	28	6.5	0.4

Code	No.	b	c	d	e	
1671499	106/B-150-SE	150	40	7.0	5.0	0.7
2015862	106/B-220-SE	220	40	7.0	5.0	
2015870	106/B-300-SE	300	40	7.0	5.0	

Code	No.	c ₁	c ₂	d	e	
2018756	106/B-150-XSE	17.5	32	5.5	3.5	
2149230	106/B-220-XSE	17.5	32	5.5	3.5	
2150263	106/B-300-XSE	17.5	32	5.5	3.5	

Code	No.	b	
1149024	106/B-150-V	150	0.8

Code	No.	b	
1149032	106/C-200-V	200	1.3

Code	No.	c	d	e	f	
1671898	108/S201*	40	7.0	5.0	15.5	

Code	No.	c ₁	c ₂	d	e	
2013711	108/XS201**	17.5	32	5.5	3.5	





SPINDLE SUMMARY

SPINDLE SUMMARY

- KS = ball tip, exchangeable



Code	No.	Size/Drive	Threads	usable length
1084739	129.106	14	M 10x1,5	160
1084445	1.1206110	14	M 12x1,5	110
1084747	129.206	14	M 12x1,75	195
1084453	1.1406050	17	M 14x1,5	50
1084461	1.1406125	17	M 14x1,5	125
1084488	1.1406140	17	M 14x1,5	140
1546821	1.1406140KS	17	M 14x1,5	140
1084798	144.15006	17	M 14x1,5	150
1084518	1.1406155	17	M 14x1,5	155
1576224	1.1406200	17	M 14x1,5	200
1084755	129.306	17	M 14x2,0	210
1084526	1.1806080	19	M 18x1,5	80
1084542	1.1806130	19	M 18x1,5	130
1084550	1.1806170	19	M 18x1,5	170
1084569	1.1806200	19	M 18x1,5	200
1084763	129.406	19	M 18x2,5	230
1084577	1.2106110	22	G 1/2"	110
1084585	1.2106160	22	G 1/2"	160
1084623	1.2106175	22	G 1/2"	175
1084593	1.2106210	22	G 1/2"	210
1546872	1.2106210KS	22	G 1/2"	210
1084631	1.2106250	22	G 1/2"	250
1084658	1.2106350	22	G 1/2"	350
1084771	129.506	22	M 20x2,5	235
1084666	1.2606180	27	G 3/4"	200
1084674	1.2606280	27	G 3/4"	280
1546910	1.2606280KS	27	G 3/4"	280
1084690	1.3306310	36	G 1"	310
1084704	1.3306360	36	G 1"	360
1084712	1.3306500	36	G 1"	500
1084720	1.4206270	41	G 1.1/4"	270

1.06/HSP

HYDRAULIC PRESSURE SPINDLE

- For controlled and safe pulling work
- Set up for a pressure of 10 t, 12 t or 15 t

Preparation for use:

- Before using, check whether the pressure spindle is screwed far enough out of the cap, so that the pressure pad is in the initial position in the hydraulic cylinder.
- Unscrew the cap from the spindle body. For this purpose, first slacken off the grub screw.
- Screw the spindle body from beneath into the cross piece of the puller until the body protrudes approx. 60 mm from the cross piece.
- Screw the cap onto the spindle body until the stop, and then fix it in position by turning in the grub screw.

Use and operation: e.g. HSP3

- Place the puller into position and pre-tension the spindle body using a size 41 mm wrench.
- Screw the pressure spindle size 17 mm into the cap. The hydraulic effect will come into use. The stroke of the pressure pad in the hydraulic cylinder is max. 12 mm. The workpiece that has been loosened by the hydraulic force may be pulled off completely by turning the spindle body with the cap size 41 mm.
- Following its use, the pressure spindle (size 17 mm) is turned back into its initial position and the pressure pad pushed into the hydraulic cylinder.

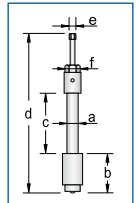

Code	No.	a	b	c	d	e	f	Stroke	max. t	max. N·m	↔
8116100	1.06/HSP1	1/2"	80	135	350	12	32	12	10	17	1.1
8116290	1.06/HSP2	3/4"	80	205	420	12	36	12	12	19	1.8
8116370	1.06/HSP3	1"	125	165	465	17	41	12	15	33	3.3

1.55

HYDRAULIC PRESS

- This piece of auxiliary equipment considerably increases the capability of the standard pressure spindle
- Operation: With pressure released, the press is placed between the pressure spindle and the end of the shaft. The pressure spindle is then tightened firmly. Care must be taken that the centreline of the shaft, the hydraulic press, and the pressure spindle are exactly in alignment. Then the hydraulic spindle is screwed inwards. Important note: Release the hydraulic press after use



Code	No.	Stroke height	Installation height	max. t	↔
8024090	1.55/1	10	75	8	1.0
8024170	1.55/2	15	90	15	1.8



Spindles - Mechanical spindle, hydraulic spindle or hydraulic press?

- The GEDORE puller mechanical spindles provide plenty of benefits: made of hardened and tempered steel, rolled fine thread and thermo-chemically treated - hence they are especially both wear and corrosion resistant.
- Particularly with high forces, using a hydraulic spindle can be both time and effort-saving. The hydraulic spindle principle is both straightforward and ingenious at the same time. The effect of screwing in the clamping bolt is to compress the grease inside the hydraulic piston - the extending piston acts on the part to be extracted with a force many times greater than that manually applied at the top. This controlled operation provides for working safely with the hydraulic spindle and is recommended, in particular, for high levels of force.
- The hydraulic press represents an alternative to the hydraulic spindle. It is attached between the mechanical spindle and shaft and through hydraulic force supports the spindle.
- As the puller cannot be rotated during extraction, pulling with the assistance of hydraulic aids saves both on time and the effort needed.





SPINDLE PRESSURE PADS

1.80

SPINDLE PRESSURE PADS for axle bores (hollow shafts)

- For the removal of bearings and gear wheels that are mounted on hollow shafts or in housings
- The spindle pressure pad serves as a counter-axis to the puller, where the spindle now transfers the force to the pressure pad

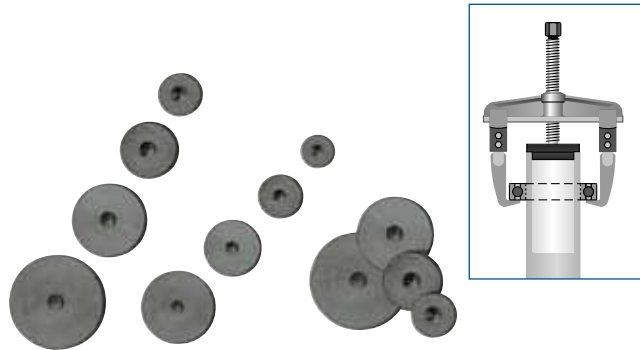

Code	No.	Plate Ø	Holder Ø	
1120697	1.80/1	25 28 32	19 22 25	2.300
		35 41 44	28 32 35	
		48 50 54	38 41 44	
		60 64	48 50	
1120700	1.80/2	67 70 73	54 57 60	2.400
		78 83 90	64 70 76	
1120719	1.80/3	41 44 48	32 35 38	4.300
		50 54 60	41 44 48	
		64 67 70	50 54 57	
		73 78 83	60 64 70	
		90	76	

BEARING ASSEMBLY

1.85/1

PROFESSIONAL PLASTIC BEARING INSTALLATION SET

- The impact-resistant plastic is handily light, but just as robust as the metal variants
- Using this bearing installation set more than 200 types of bearings may be re-installed effortlessly and without damage

Set comprises:

- 33 impact rings
- 3 aluminium impact sleeves, 10-50 mm for external Ø 26-110 mm
- 1 recoil-free bodywork hammer with nylon heads
- In a strong plastic case, dimensions 450 x 360 x 140 mm



Code	No.	
1120778	1.85/1	5.2

SAFETY COVER

5.10

SAFETY COVER SIZE 1

- At pulling forces of 18 t, these PVC safety covers provide maximum active-safety protection from suddenly detaching ball bearings, driving pinions or small parts. The safety covers are extremely flexible, making them suitable for all situations.
- Dimensions 510 x 915 mm
- Double-ply welded = double safety (total thickness at 0.5 mm = 1.0 mm)
- Tear strength: longitudinal 23 N/mm² - lateral 21 N/mm²
- Two straps for variable adjustment
- Press stud fasteners for added safety - no flapping ends
- UV resistant
- Temperature resistant at -25°C to +50°C
- Storage in the supplied carry bag guarantees long service life



Code	No.	
1868195	5.10	1.5



136 K

CHAIN GRIP WRENCH

- Particularly suited for clamping geometrically problematical cross-sections
- With No. 136 K-105 the legs of various pullers - following locking - can be spanned with the chain at the component to be extracted and tightened. This stops the legs bending outwards and slipping. Pulling is still possible even if the legs have a very restricted contact surface



Code	No.	↳mm↳	
2307227	136 K-105	1050	





1.08

UNIVERSAL PULLER 2-arm pattern, with fast spindle adjustment

- Twice as fast and twice as simple
- With the fast spindle adjustment feature, the spindle can be set the desired range in a moment. When the clamping yoke is released, the 4-part internal thread closes, and takes the full working pressure

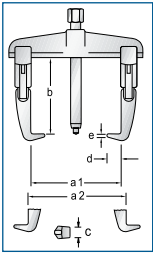

Code	No.	a ₁	a _{2 min}	a _{2 max}	b	mm	mm	c	d	e	max. t	mm
8019090	1.08/1A	130	80	180	100	M 14x1,5 x 140	17	22	12	3.0	3.0	1.5
8000070	1.08/2A	200	110	260	150	G 1/2 x 210	22	30	18	3.5	5.0	4.1
8018950	1.08/3A	350	130	420	200	G 3/4 x 280	27	36	28	6.5	7.5	10.2

3-ARM EXTERNAL PULLER TWIST + PULL



**1.09 PULLER TWIST & PULL
EASY, QUICK AND SAFE**

Working principle



Advantages:

- No setting-up or readjusting of the legs
- Maintenance-free due to encapsulated mechanics

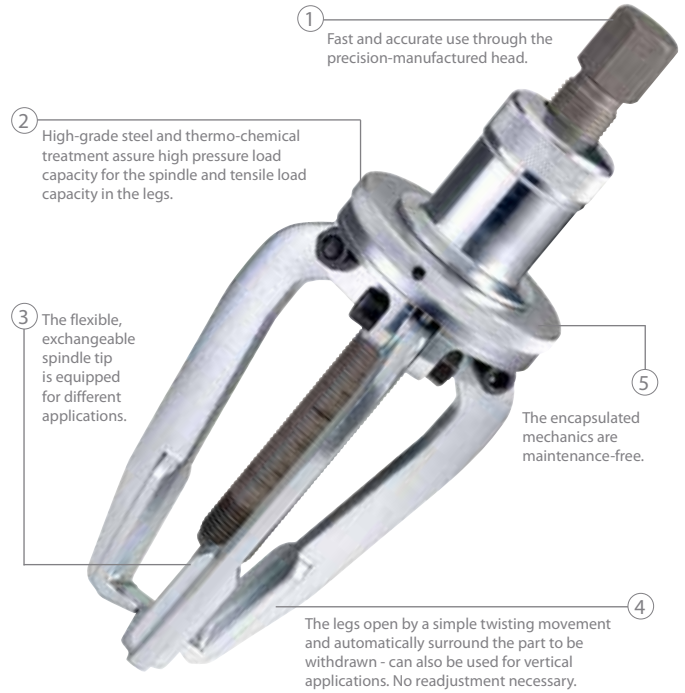

1.09

PULLER TWIST+PULL 3-arm pattern, with rotating adjustment

- The precise manufactured head allows fast and exact use
- The legs open by simple rotation and enclose automatically the part to be removed
- No more time-consuming set-up and readjusting of the legs
- High-quality steel and thermo-chemical treatment guarantee highest toughness of the spindle and the legs
- Ball or tip can easily be exchanged

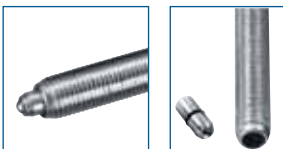
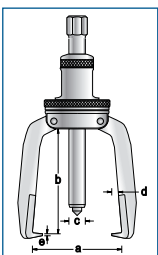

Code	No.	a _{min}	a _{max}	b	mm	mm	c	d	e	max. t	mm
1748173	1.09/1	30	150	130	G 1/2 x 250	22	17	12	3.0	6.5	2.5
1748181	1.09/2	80	250	250	G 1/2 x 350	22	24	12	3.0	6.5	4.2



2-/3-ARM FAN / BATTERY-TERMINAL PULLERS

1.10

PULLER 2-arm pattern

- The reliable, heavy-duty model for the removal of pulleys, wheels, ball bearings, etc.
- The double leg ends, wide or narrow, grip automatically
- The wide leg ends of the puller 1.10/2, /3, /4 and /5 possess 8 mm slots, so that pulleys or gears may also be pulled off using 8 mm bolts

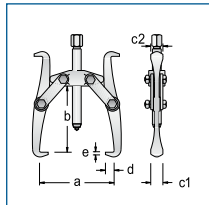

1.10/1

1.10/2-5

Code	No.	a _{max}	b	—	● mm	c ₁	c ₂	d	e	max. t	↔
8002600	1.10/1	90	80	M 14x1,5 x 125	17	17	10	7	2	2.0	0.7
8002790	1.10/2	160	130	M 18x1,5 x 170	19	24	20	13	3	5.0	2.0
1731874	1.10/3	220	170	M 18x1,5 x 170	19	24	20	13	3	5.0	2.3
1731882	1.10/4	320	260	G 1/2 x 350	22	27	32	27	3	8.0	5.1
1731890	1.10/5	400	320	G 1/2 x 350	22	27	32	27	3	8.0	5.8

1.11

PULLER 3-arm pattern

- The reliable, heavy-duty model for the removal of pulleys, wheels, ball bearings, etc.
- The double leg ends, wide or narrow, grip automatically
- The wide leg ends of the puller 1.11/2, /3, /4 and /5 possess 8 mm slots, so that pulleys or gears may also be pulled off using 8 mm bolts

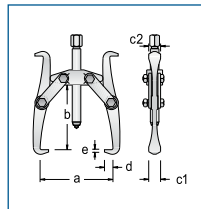

1.11/1

1.11/2-5

Code	No.	a _{max}	b	—	● mm	c ₁	c ₂	d	e	max. t	↔
8002950	1.11/1	90	80	M 14x1,5 x 125	17	17	10	7	2	3.0	0.9
8003090	1.11/2	160	130	M 18x1,5 x 170	19	24	20	13	3	7.5	2.6
1731904	1.11/3	220	170	M 18x1,5 x 170	19	24	20	13	3	7.5	3.2
1731912	1.11/4	320	260	G 1/2 x 350	22	27	32	27	3	12.0	5.8
1731920	1.11/5	400	320	G 1/2 x 350	22	27	32	27	3	12.0	8.0

110

PULLING LEG

- Double ended with wide or narrow grips
- Complete with clips and screws

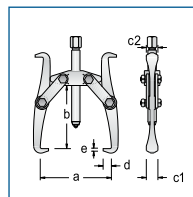

110/1

110/2-5



Code	No.	↔	b	c ₁	c ₂	d	e	↔
2303086	110/1-080	1.10/1 + 1.11/1	80	17	10	7	2	0.2
2303094	110/2-130	1.10/2 + 1.11/2	130	24	20	13	3	0.6
2303108	110/3-170	1.10/3 + 1.11/3	170	24	20	13	3	0.8
2303116	110/4-260	1.10/4 + 1.11/4	260	27	32	27	3	1.7
2303124	110/5-320	1.10/5 + 1.11/5	320	27	32	27	3	1.8



1.12

BATTERY-TERMINAL PULLER 2-arm pattern

- ✔ Ideal for removing small parts such as battery terminals, pulleys, wheels, ball bearings, etc.
- ✔ The legs grip automatically

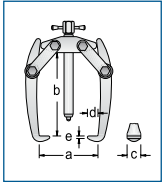

Code	No.	a _{max}	b	—	c	d	e	max. t	↕↔
8003840	1.12/02	60	40	M 10x1,5 x 60	10	5	2	0.5	160
8003760	1.12/01	60	60	M 10x1,5 x 80	10	5	2	0.5	180
1628402	1.12/00	70	80	M 10x1,5 x 100	14	8	2	0.5	300

1.12

PULLER 2-arm pattern

- ✔ Handy robust model for the removal of pulleys, wheels, ball bearings, etc.
- ✔ Inexpensive economy model
- ✔ The legs grip automatically

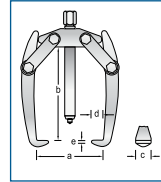

Code	No.	a _{max}	b	—	● mm	c	d	e	max. t	↕↔
8003250	1.12/0	70	80	M 12x1,5 x 110	14	14	8	2	1.0	0.4
8003330	1.12/1	90	120	M 14x1,5 x 155	17	18	11	2	2.0	0.8
8003410	1.12/2	130	160	M 18x1,5 x 200	19	25	14	3	5.0	1.9
8003680	1.12/3	180	200	G 1/2 x 250	22	32	20	4	8.0	3.7

1.13

BATTERY-TERMINAL PULLER 3-arm pattern

- ✔ Ideal for removing small parts such as battery terminals, pulleys, wheels, ball bearings, etc.
- ✔ The legs grip automatically

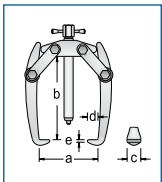

Code	No.	a _{max}	b	—	c	d	e	max. t	↕↔
8004650	1.13/02	60	40	M 10x1,5 x 60	10	5	2	0.75	0.2
8004570	1.13/01	60	60	M 10x1,5 x 80	10	5	2	0.75	0.2
1628410	1.13/00	70	80	M 10x1,5 x 100	14	8	2	1.0	0.4

1.13

PULLER 3-arm pattern

- ✔ Handy robust model for the removal of pulleys, wheels, ball bearings, etc.
- ✔ Inexpensive economy model
- ✔ The legs grip automatically

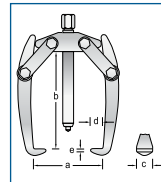

Code	No.	a _{max}	b	—	● mm	c	d	e	max. t	↕↔
8004140	1.13/0	70	80	M 12x1,5 x 110	14	14	8	2	2.0	0.5
8004220	1.13/1	90	120	M 14x1,5 x 155	17	18	11	2	3.0	1.5
8004300	1.13/2	130	160	M 18x1,5 x 200	19	25	14	3	7.5	2.5
8004490	1.13/3	180	200	G 1/2 x 250	22	32	20	4	12.0	5.3

112

PULLING LEG

- ✔ Complete with clips and screws



Code	No.	↕↔	b	c	d	e	↕↔
2303132	112/02-040	1.12/02 + 1.13/02	40	10	5	2	0.1
2303140	112/01-060	1.12/01 + 1.13/01	60	10	5	2	0.1
2303159	112/00-080	1.12/00 + 1.13/00	80	14	8	2	0.1

112

PULLING LEG

- ✔ Complete with clips and screws



Code	No.	↕↔	b	c	d	e	↕↔
2303167	112/0-080	1.12/0 + 1.13/0	80	14	8	2	0.1
2303175	112/1-120	1.12/1 + 1.13/1	120	18	11	2	0.2
2303183	112/2-160	1.12/2 + 1.13/2	160	25	14	3	0.6
2303191	112/3-200	1.12/3 + 1.13/3	200	32	20	4	1.1



1.14

PULLER 2-arm pattern

- The reliable, extra-strong model for the removal of pulleys, wheels, ball bearings, etc.
- With technical and economical benefits due to the variable clamping reach and automatic grip of the legs
- Especially suited to removing V-belt pulley wheels and flywheels mounted on longer shafts
- Upgradeable with hydraulic spindle (see table)

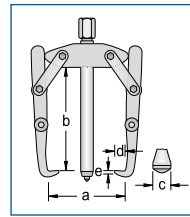

Code	No.	a _{max}	b	⌀	⌀	● mm	c	d	e	max. t	↔
8004810	1.14/0	90	100	M 12x1,5 x 110		14	14	9	2.0	1.0	0.4
8005030	1.14/1	130	140	M 14x1,5 x 140		17	18	11	2.0	2.0	0.9
8005380	1.14/2	200	210	M 18x1,5 x 200		19	25	16	3.0	5.0	2.2
8005460	1.14/3	250	260	G 1/2 x 250	1.06/HSP1	24	32	18	3.5	8.0	4.4
8005540	1.14/4	280	390	G 1/2 x 250	1.06/HSP1	24	32	20	3.5	8.0	5.1
8005620	1.14/5	420	480	G 1/2 x 350	1.06/HSP1	24	32	20	3.5	8.0	6.0

1.15

PULLER 3-arm pattern

- The reliable, extra-strong model for the removal of pulleys, wheels, ball bearings, etc.
- With technical and economical benefits due to the variable clamping reach and automatic grip of the legs
- Especially suited to removing V-belt pulley wheels and flywheels mounted on longer shafts
- Upgradeable with hydraulic spindle (see table)

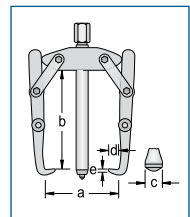

Code	No.	a _{max}	b	⌀	⌀	● mm	c	d	e	max. t	↔
8006000	1.15/0	90	100	M 12x1,5 x 110		14	14	9	2.0	2.0	0.5
8006190	1.15/1	130	140	M 14x1,5 x 140		17	18	11	2.0	3.0	1.2
8006350	1.15/2	200	210	M 18x1,5 x 200		19	25	16	3.0	7.5	3.3
8006430	1.15/3	250	260	G 1/2 x 250	1.06/HSP1	24	32	18	3.5	12.0	6.3
8006510	1.15/4	280	390	G 1/2 x 250	1.06/HSP1	24	32	20	3.5	12.0	7.7
8006780	1.15/5	420	480	G 1/2 x 350	1.06/HSP1	24	32	20	3.5	12.0	8.9

1.15/HSP

PULLER hydraulic, 3-arm pattern

- The reliable, extra-strong model for the removal of pulleys, wheels, ball bearings, etc.
- With technical and economical benefits due to the variable clamping reach and automatic grip of the legs
- Especially suited to removing V-belt pulley wheels and flywheels mounted on longer shafts
- With the hydraulic spindle, a controlled and safe pulling action is possible at all times

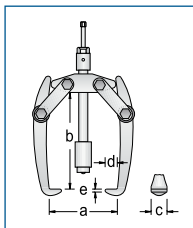

Code	No.	a _{max}	b	⌀	● mm	c	d	e	max. t	N-m	↔
1392956	1.15/3-HSP1	250	180	1.06/HSP1	32	32	18	3.5	10	17	6.6
1392980	1.15/4-HSP1	280	310	1.06/HSP1	32	32	20	3.5	10	17	8.1

114

PULLING LEG

- With variable clamping reach
- Complete with clips and screws

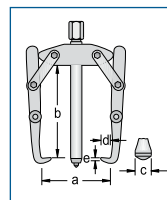

Code	No.	↔	b	c	d	e	↔
2303213	114/0-100	1.14/0 + 1.15/0	100	14	9	2.0	0.1
2303221	114/1-140	1.14/1 + 1.15/1	140	18	11	2.0	0.3
2303248	114/2-210	1.14/2 + 1.15/2	210	25	16	3.0	0.8
2303256	114/3-260	1.14/3 + 1.15/3 1.15/3-HSP1	260	32	18	3.5	1.5
2303264	114/4-390	1.14/4 + 1.15/4 1.15/4-HSP1	390	32	20	3.5	1.8
2303272	114/5-480	1.14/5 + 1.15/5	480	32	20	3.5	2.2



1.14/L

FAN PULLER 2-arm pattern

- Especially slender legs will each adjust to 3 clamping positions

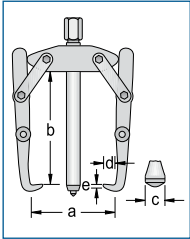

Code	No.	a _{max}	b	⌀	mm	c	d	e	max. t	Ⓢ
8005110	1.14/1L	150	200	M 14x1,5 x 155	17	10	6	2	2.0	0.9

114/L

PULLING LEG

- With variable clamping reach
- Complete with clips and screws

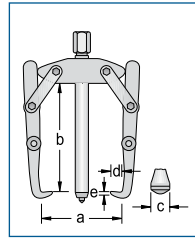

Code	No.	Ⓢ	b	c	d	e	Ⓢ
2303310	114/1-200-L	1.14/1L + 1.15/1L	200	10	6	2	0.3

1.15/L

FAN PULLER 3-arm pattern

- Especially slender legs will each adjust to 3 clamping positions

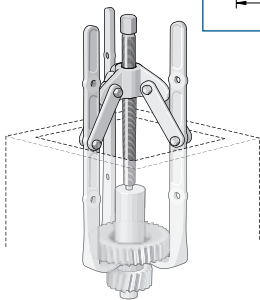
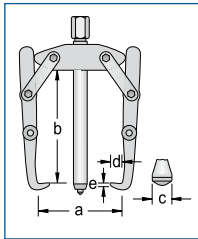

Code	No.	a _{max}	b	⌀	mm	c	d	e	max. t	Ⓢ
8006270	1.15/1L	150	200	M 14x1,5 x 155	17	10	6	2	3.0	1.3



1.16

PULLER 2-arm pattern

- Very strong
- Made for industrial applications and for use on heavy agricultural and construction machines
- The legs grip automatically
- Upgradeable with hydraulic spindle (see table)

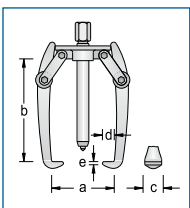

Code	No.	a _{max}	b	⌀	mm	c	d	e	max. t	Ⓢ
8007080	1.16/1	300	300	G 1 x 360	1.06/HSP3	36	32	19	3.0	8.0 8.4
8007160	1.16/2	450	420	G 1 x 500	1.06/HSP3	36	32	22	3.0	8.0 10.0

1.17

PULLER 3-arm pattern

- Very strong
- Made for industrial applications and for use on heavy agricultural and construction machines
- The legs grip automatically
- Upgradeable with hydraulic spindle (see table)
- For the assembly of a 2- or 3-arm puller

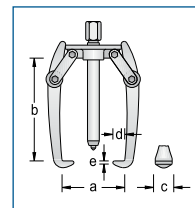

Code	No.	a _{max}	b	⌀	mm	c	d	e	max. t	Ⓢ
8007320	1.17/1	300	300	G 1 x 360	1.06/HSP3	36	32	19	3.0	12.0 10.5
8007400	1.17/2	450	420	G 1 x 500	1.06/HSP3	36	32	22	3.0	12.0 12.7



1.16/HSP

PULLER hydraulic, 2-arm pattern

- Very strong
- Made for industrial applications and for use on heavy agricultural and construction machines
- The legs grip automatically
- With the hydraulic spindle, a controlled and safe pulling action is possible at all times

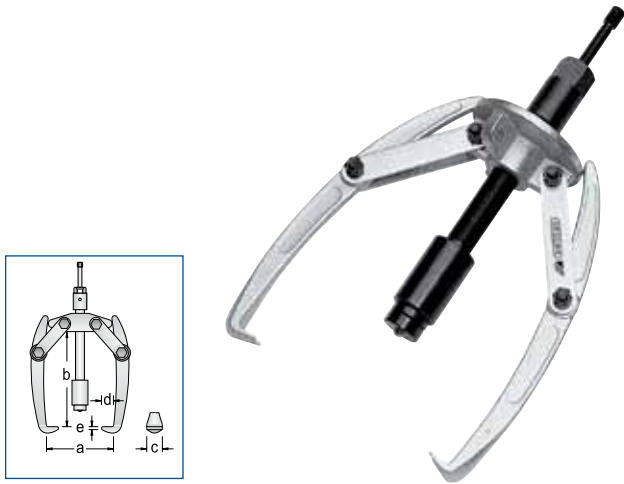

Code	No.	a _{max}	b	mm	c	d	e	max. t	max. N-m	mm	
8012590	1.16/1-HSP3	300	190	1.06/HSP3	41	32	19	3.0	8.0	22	8.7
8012670	1.16/2-HSP3	450	310	1.06/HSP3	41	32	22	3.0	8.0	22	10.2

116

PULLING LEG

- Very strong
- Complete with clips and screws

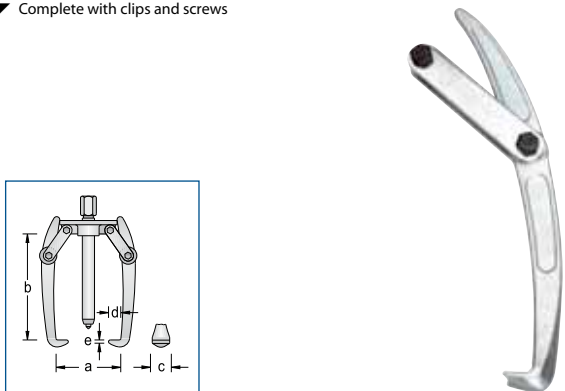

Code	No.	mm	b	c	d	e	mm
2303280	116/1-300	1.16/1 + 1.17/1 1.16/1-HSP3 + 1.17/1-HSP3	300	32	19	3	1.8
2303299	116/2-420	1.16/2 + 1.17/2 1.16/2-HSP3 + 1.17/2-HSP3	300	32	22	3	2.2

1.18

PULLER 2-arm pattern

- The tried and tested range for economical bearing removal



Code	No.	a _{max}	b	mm	c	d	e	max. t	mm
1464965	1.18/1	110	110	M 14x1,5 x 163	17	18	5.0	2.0	1.1
1464973	1.18/2	160	140	M 18x1,5 x 215	21	20	6.5	3.0	2.1
1464981	1.18/3	200	200	G 1/2 x 282	22	22	7.5	5.0	3.4

1.17/HSP

PULLER hydraulic, 3-arm pattern

- Very strong
- Made for industrial applications and for use on heavy agricultural and construction machines
- The legs grip automatically
- With the hydraulic spindle, a controlled and safe pulling action is possible at all times

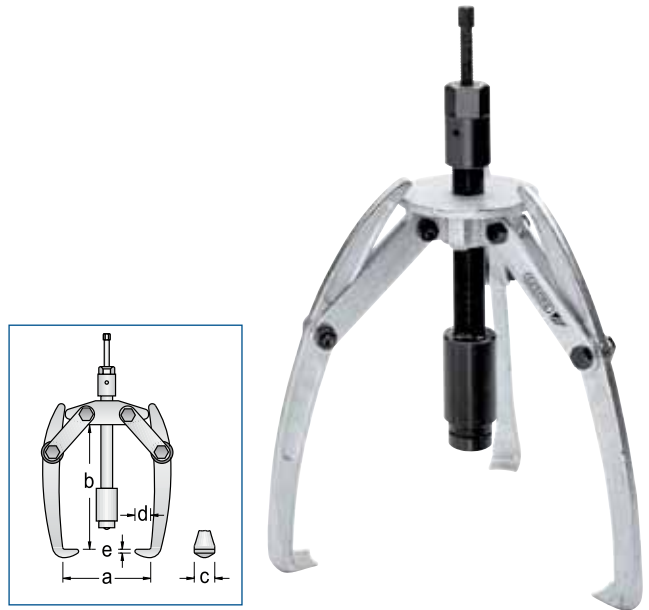

Code	No.	a _{max}	b	mm	c	d	e	max. t	max. N-m	mm	
8014290	1.17/1-HSP3	300	190	1.06/HSP3	41	32	19	3.0	12.0	29	11.4
8014370	1.17/2-HSP3	450	310	1.06/HSP3	41	32	22	3.0	12.0	29	12.7



1.18 / 1.19



406



1.19

PULLER 3-arm pattern

- The tried and tested range for economical bearing removal

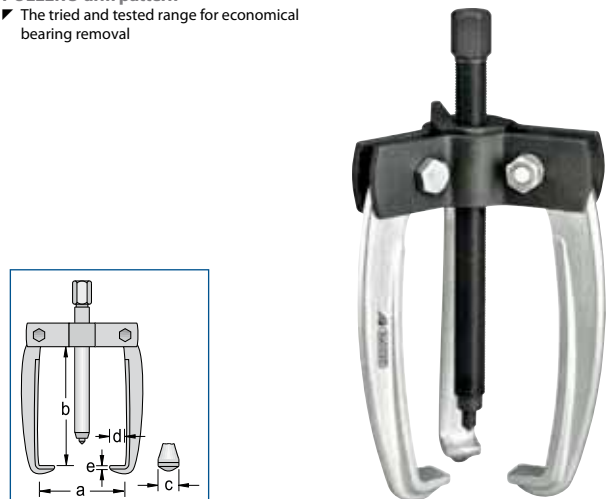

Code	No.	a _{max}	b	mm	c	d	e	max. t	mm
1465007	1.19/1	110	110	M 14x1,5 x 163	17	18	5.0	2.0	1.4
1465015	1.19/2	160	140	M 18x1,5 x 215	21	20	6.5	3.0	2.7
1465023	1.19/3	200	200	G 1/2 x 282	22	22	7.5	5.0	4.5



1.18

FAN PULLER 2-arm pattern

Removes bearings swiftly and cleanly

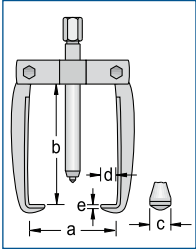

Code	No.	a _{max}	b	⌀	c	d	e	max. t	↕
1656996	1.18/02	65	50	M 10 x 115	12	10	3.0	1.0	0.2
1657089	1.18/01	70	70	M 10 x 115	12	10	3.0	1.0	0.2
1656937	1.18/0	80	80	M 10 x 115	12	10	3.0	1.0	0.2

1.19

FAN PULLER 3-arm pattern

Removes bearings swiftly and cleanly

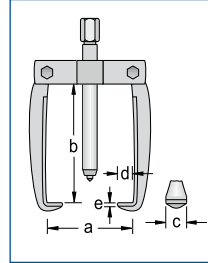

Code	No.	a _{max}	b	⌀	c	d	e	max. t	↕
1657054	1.19/02	65	50	M 10 x 115	12	10	3.0	1.0	0.3
1657046	1.19/01	70	70	M 10 x 115	12	10	3.0	1.0	0.3
1657011	1.19/0	80	80	M 10 x 115	12	10	3.0	1.0	0.3

1.20

PULLER with clamping yoke

These pullers are mainly employed for removing car and truck steering arms
The clamping yoke applies firm pressure behind the part to be moved and keeps the puller firmly in the correct position

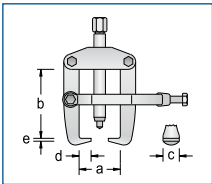

Code	No.	a _{max}	b	⌀	⌀mm	c	d	e	max. t	↕
8008050	1.20/1	90	85	M 18x1,5 x 130	19	22	12	3.0	5.0	1.6
8008130	1.20/2	90	100	M 18x1,5 x 130	19	24	15	3.0	5.0	1.7
8008210	1.20/3	150	140	G 1/2 x 175	22	30	18	3.5	7.5	3.4

1.19/SH

PULLER WITH IMPACT HAMMER

The tried and tested range for economical bearing removal, spindle not supplied
Impact weight: 700 g

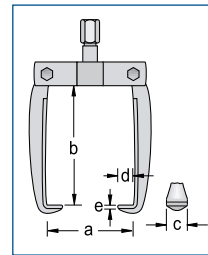

Code	No.	a _{max}	b	c	d	e	max. t	↕
2178001	1.19/01-SH1A	70	70	12	10	3.0	1.0	1.2



CLAMPING YOKE

The clamping yokes stop the legs bending outwards under load and thus possibly slipping.
This can also be attained using the new GEDORE 136 K clamping chain – even with a very restricted contact surface of the legs extracting can still be done.

136 K

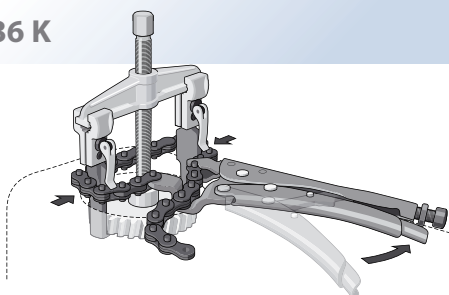

379

1.22

PULLER with clamping yoke

Double-ended hooks
Particularly suitable for separating and removing flush-seated parts
Especially economical as it covers a range of different sizes

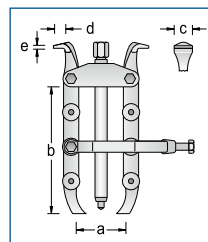

Code	No.	a _{max}	b	⌀	⌀mm	c	d	e	max. t	↕
8009020	1.22/1	110	170	M 18x1,5 x 200	19	25	14	3.5	5.0	2.2
8009100	1.22/2	160	260	G 1/2 x 350	22	25	14	3.5	7.5	4.4
8009290	1.22/3	160	325	G 1/2 x 350	22	25	14	3.5	7.5	4.6



1.18/XS

PULLER with extra slim legs

- Very slim forged legs
- Ideal for use in hard-to-reach places, e.g. work on electric motors

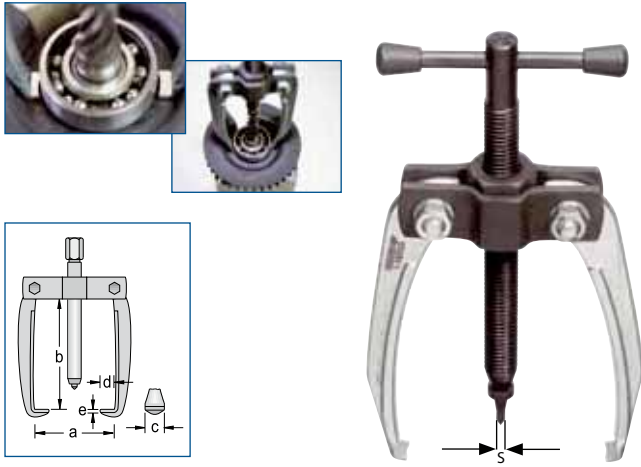

Code	No.	a _{max}	b	mm	c	d	e	s	max. t	↔
2018594	1.18/OXS	50	70	M 10x1,5 x 100	8	3	2	2,9	0.5	240

1.19/XS

PULLER with extra slim legs

- Very slim forged legs
- Ideal for use in hard-to-reach places, e.g. work on electric motors

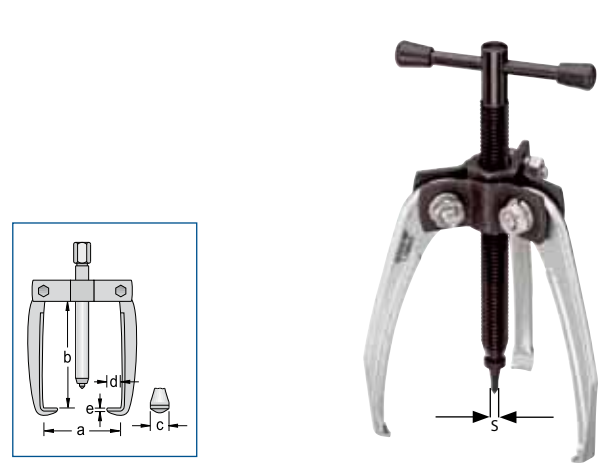

Code	No.	a _{max}	b	mm	c	d	e	s	max. t	↔
2018608	1.19/OXS	50	70	M 10x1,5 x 100	8	3	2	2,9	0.8	300

1.23

PULLER with slim legs

- For removing bearings in confined spaces
- The legs grip automatically
- No. 1.23/S: particularly slim legs

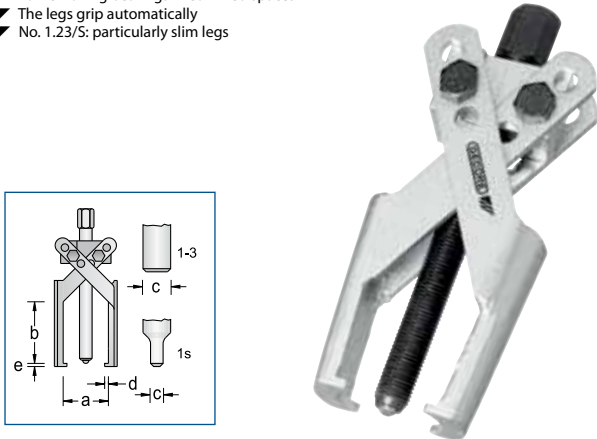

Code	No.	a _{max}	b	mm	c	d	e	s	max. t	↔
8084580	1.23/1S	80	85	M 10 x 105	12	11	4	2.5	1.5	0.4
8084310	1.23/1	80	85	M 10 x 105	12	23	4	2.5	2.0	0.4
8084660	1.23/2	120	120	M 14x1,5 x 130	17	31	5	3.5	3.5	0.8
8084740	1.23/3	120	150	M 14x1,5 x 205	17	31	5	3.5	3.5	1.1

1.23/XS

PULLER with extra slim legs

- Very slim forged legs
- Ideal for use in hard-to-reach places, e.g. work on electric motors
- The legs grip automatically

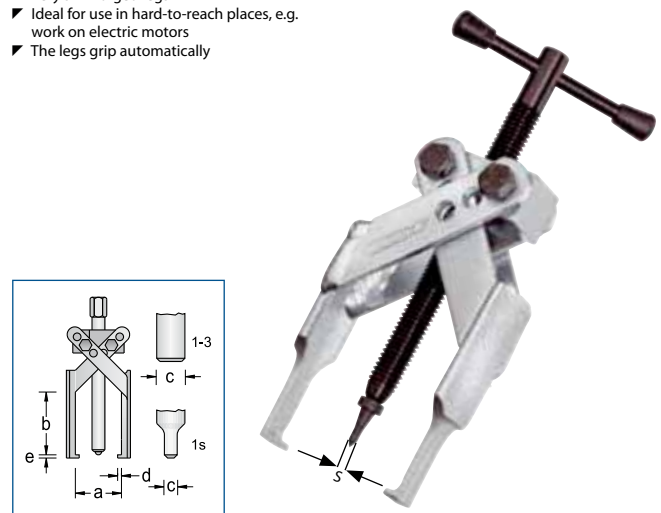

Code	No.	a _{max}	b	mm	c	d	e	s	max. t	↔
2018578	1.23/1XS	80	85	M 10x1,5 x 100	9	3.5	2	2,9	0.7	330

1.06/XS • 1.07/XS



369
373





HYDRAULIC IMPLEMENTS

1.50

HYDRAULIC IMPLEMENTS

- ✔ Suitable for pressing, straightening, lifting, bending, and pulling
- ✔ Consisting of hydraulic hand pump 1.50/1 and hydraulic cylinder 1.51



Code	No.	consisting of:	⚖
8110410	1.50/10	Hydraulic hand pump 1.50/1 Hydraulic cylinder 1.51/10	14.0
8110680	1.50/11	Hydraulic hand pump 1.50/1 Hydraulic cylinder 1.51/11	15.1

1.50/1

HYDRAULIC HAND PUMP

- ✔ Complete with 1.50 m high-pressure hose
- ✔ To fit hydraulic cylinder 1.51
- ✔ Up to 700 bar



Code	No.	for hydraulic cylinder	⚖
8022710	1.50/1	1.51/10 1.51/11	8.3

1.51

HYDRAULIC CYLINDER

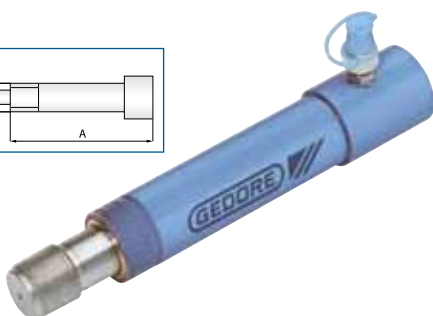
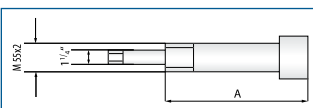

Code	No.	Stroke height	A	max. t	⚖
8023440	1.51/10	150	275	10	5.0
8110760	1.51/11	230	355	10	6.0

1.51/V

EXTENSION FOR 1.51/10 + 11

- ✔ 1.51/V015 are used to protect the cylinder/piston
- ✔ The 1.51/V045, 1.51/V125 and 1.51/V205 extensions are attached to the hydraulic cylinder using adapter 1.51/A-2



Code	No.	Description	⚖
2065045	1.51/V015	Extension and cylinder protection, 15 mm	0.4
2065053	1.51/V045	Extension for hydraulic cylinder, 45 mm	0.5
2065061	1.51/V125	Extension for hydraulic cylinder, 125 mm	0.9
2065088	1.51/V205	Extension for hydraulic cylinder, 205 mm	1.3
2065096	1.51/A-2	Adaptor for 1.51/V045 - V205	0.5



HYDRAULIC IMPLEMENTS

- ✔ As the puller cannot be rotated during extraction, pulling with the assistance of hydraulic aids - hydraulic implements, hydraulic spindle or hydraulic press - saves both on time and the effort needed.

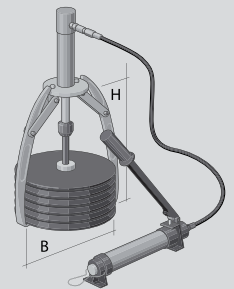

- ✔ The hydraulic implements can also be used with the 1.07/4 and 1.07/4A pullers.



1.07/4



371



**1.06/H****PULLER for hydraulic implement 1.50**

- For the fast and damage-free removal of pulleys, wheels, ball bearings, etc.
- Robust pattern, designed for rigidity and heavy duty use
- By reversing the legs, this tool can be used as an internal or external puller
- The reach may be increased both by using pulling legs in special lengths, and by using extensions

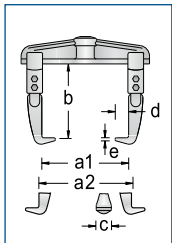

Code	No.	a ₁	a _{2 min}	a _{2 max}	b	c	d	e	max. t	↕
8112620	1.06/40	520	185	600	200	36	28	6.5	10.0	11.0

1.15/H**PULLER for hydraulic implement 1.50**

- Heavy-duty pattern for the removal of gear wheels, spoked wheels, pulleys, etc.
- The legs grip automatically
- The legs can be moved for use as a 2-arm puller
- The adjustable reach means that this puller is very versatile

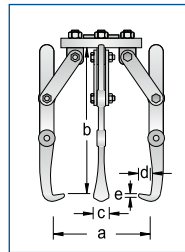

Code	No.	a _{min}	b	c	d	e	max. t	↕
8006860	1.15/30	250	260	32	18	3.5	12.0	9.0
8109590	1.15/40	280	390	32	20	3.5	12.0	9.2

**1.17/H****UNIVERSAL PULLER for hydraulic implement 1.50**

- Heavy-duty pattern for the removal of gear wheels, spoked wheels, pulleys, etc
- The legs grip automatically

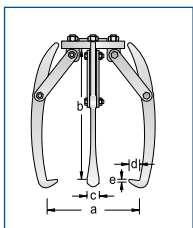

Code	No.	a _{max}	b	c	d	e	max. t	↕
8007590	1.17/10	300	300	36	19	3.5	12.0	9.1
8109670	1.17/20	425	425	36	22	3.5	12.0	12.4

**5.10****Remember the safety cover!****379**

SEPARATORS

1.38

SEPARATOR PULLER

- These separator pullers are used together with the bearing separators 1.40
- The tension bolts are screwed into the threaded holes in the bearing separators

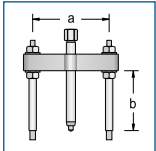

Code	No.	for separator	a	b	⌀	⌀ M	⌀ mm	⌀	⌀
8017550	1.38/0	1.40/0	40-120	125	M 14 x 120	M10 / M12x1,5	17	-	1.0
8017630	1.38/1	1.40/1	60-165	180	M 18 x 170	M10 / M14x1,5	19	-	1.1
8017710	1.38/2	1.40/2	70-215	195	G 1/2 x 210	M14x1,5 / M16x1,5	22	1.06/HSP1	3.4
8017980	1.38/3	1.40/3	90-300	205	G 3/4 x 280	M18x1,5 / M20x1,5	27	1.06/HSP2	6.5
8018010	1.38/4	1.40/4	125-380	275	G 1 x 310	M22x1,5 / M24x1,5	36	1.06/HSP3	11.6
8018280	1.38/5	1.40/5	140-440	320	G 1 x 360	M24x1,5 / M26x1,5	36	1.06/HSP3	16.6

1.38/V

EXTENSION ROD

- Extension rods for separator pullers 1.38



Code	No.	for separator	⌀ M	⌀ mm	⌀
8018440	1.38/AV	1.38/0 1.38/1	M10	100	0.3
8018520	1.38/CV	1.38/2	M14x1,5	100	0.3
8018600	1.38/DV	1.38/3	M18x1,5	100	0.7
8018790	1.38/EV	1.38/4	M22x1,5	200	2.1
8018870	1.38/FV	1.38/5	M24x1,5	200	2.7

1.38/HSP

SEPARATOR PULLER hydraulic

- For use with separating blades 1.40
- The tension bolts are screwed into the threaded bores of the separating blades

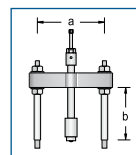

Code	No.	for separator	⌀ M	a	b	⌀
8014960	1.38/2-HSP1	1.40/2	M14x1,5	70-215	175	3.9
8015180	1.38/3-HSP2	1.40/3	M18x1,5	90-300	195	7.1
8015420	1.38/4-HSP3	1.40/4	M22x1,5	125-380	240	12.6
8015500	1.38/5-HSP3	1.40/5	M24x1,5	140-440	290	17.4



**1.40****SEPARATOR**

- For removing taper roller and ball bearings, inner bearing races, and other tightly-seated or thin-walled parts
- Operation: To remove tightly-seated parts, the sharp edges of the separator blades are pressed behind the part and it is then withdrawn using the correct puller no. 1.38. To avoid damage to delicate parts, the flat surfaces of the separator blades are used. This produces a large support surface that prevents deformation.



Code	No.	for puller	M	mm	
8019680	1.40/0	1.38/0	M10	5-60	0.5
8019760	1.40/1	1.38/1	M10	12-75	0.9
8019840	1.40/2	1.38/2	M14x1,5	22-115	2.4
8019920	1.40/3	1.38/3	M18x1,5	30-155	4.7
8020180	1.40/4	1.38/4	M22x1,5	30-200	8.9
8020260	1.40/5	1.38/5	M24x1,5	30-250	15.3

1.41**SEPARATOR AND PULLER SET**

- Set comprising separator, puller, and extension rods
- In sheet metal case



Code	No.	Contents	
8109750	1.41/0	1.38/0 1.38/AV 1.40/0	2.8
8109830	1.41/1	1.38/1 1.38/AV 1.40/1	5.3
8109910	1.41/2	1.38/2 1.38/CV 1.40/2	9.0
8110090	1.41/3	1.38/3 1.38/DV 1.40/3	16.0
8110170	1.41/4	1.38/4 1.38/EV 1.40/4	28.6

**Separator pullers 1.38 and 1.40**

- GEDORE separating blades are particularly suited for removing taper roller and ball bearings, inner bearing races and other tightly-seated or thin-walled parts.
- To remove tightly-seated parts, the sharp edges of the separator blades are pressed behind the part to be removed which is then withdrawn using the correct 1.38 separator puller.
- To avoid damage to delicate parts, the flat surfaces of the separator blades are used. This produces a large contact surface that prevents tilting.
- The clamping reach can be enlarged with the aid of the 1.38/AV - FV tension bolt extensions.

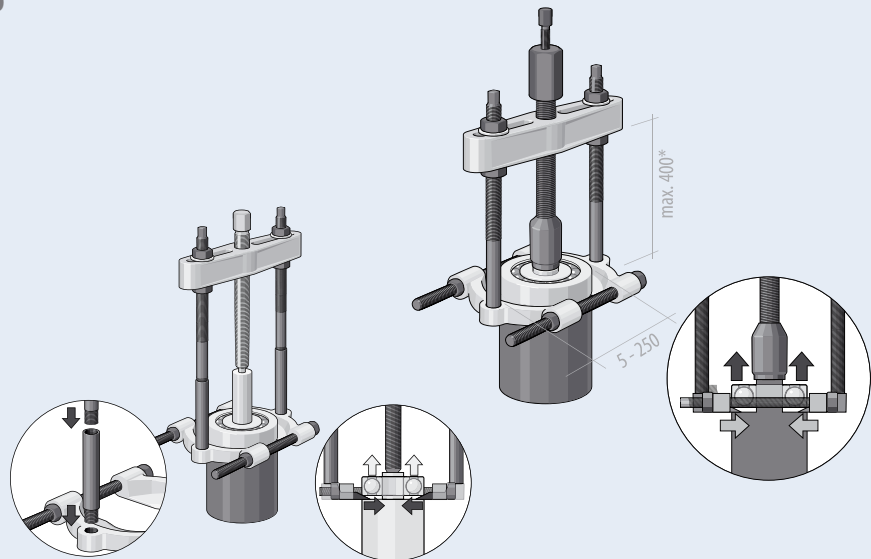
**923****487****920****487**



1.92 EXTRACTOR

Better solutions through innovative and precise technology



The solution for ball bearings, which are mounted on a shaft or in a housing, and thus cannot be extracted neither from the inside nor from the outside.

FIELDS OF APPLICATION



Suitable for more than 40 standard ball bearings up to 6311

①

The innovative design with its maximum level of functionality in connection with simple handling provides a PLUS in effectivity and productivity.

②

The top plate is easy to use. The legs are fixed in the slot.

③

The self-locking system guarantees 100% force transmission and the maximum safety during withdrawal

WORKING PRINCIPLE



In view of the different ball bearing constructions dependent on manufacturer, the table presented can only serve as an orientation guide in selecting the legs and heads.

1.92

BALL BEARING EXTRACTOR PLUS

- Using the ball bearing extractor, the removal of shaft-mounted ball bearings in a housing is now possible without any problems
- Due to its great degree of functionality combined with the simplified handling, this design makes a PLUS in effectiveness and productivity possible
- This tool is easy to use: The legs are fixed in the slot
- The self-locking arrangement means that the force applied is 100% utilised
- Secure at all times against slipping off - and a straight pulling force for precise working
- Suitable for more than 40 standard ball bearings up to 6311
- 1.92/1 for bearings: 6000-6010, 6200-6205, 6300-6304
- 1.92/2 for bearings: 6011-6012, 6206-6212, 6305-6311, 6403-6407
- 1.92/12 contains set 1.92/1 and 1.92/2



1.92/12

Code	No.	Bearing	Leg	Head size	Weight
1553534	1.92/1	6000	1.92/10	192/1-7	2.3
		6001	1.92/10	192/1-4	
		6002	1.92/10	192/1-3	
		6003	1.92/10	192/1-4	
		6004	1.92/30	192/1-3	
		6005	1.92/30	192/1-3	
		6006	1.92/30	192/1-3	
		6007	1.92/40	192/1-3	
		6008	1.92/40	192/1-3	
		6009	1.92/40	192/1-3	
		6010	1.92/40	192/1-3	
		6200	1.92/10	192/1-4	
		6201	1.92/20	192/1-7	
		6202	1.92/20	192/1-4	
		6203	1.92/30	192/1-4	
		6204	1.92/40	192/1-4	
		6205	1.92/40	192/1-3	
		6300	1.92/30	192/1-3	
		6301	1.92/40	192/1-3	
		6302	1.92/40	192/1-7	
6303	1.92/40	192/1-7			
6304	1.92/40	192/1-7			

Code	No.	Bearing	Leg	Head size	Weight
1553542	1.92/2	6011	1.92/50	192/2-3	5.2
		6012	1.92/50	192/2-3	
		6206	1.92/50	192/2-3	
		6207	1.92/50	192/2-3	
		6208	1.92/60	192/2-3	
		6209	1.92/60	192/2-3	
		6210	1.92/60	192/2-3	
		6211	1.92/60	192/2-3	
		6212	1.92/70	192/2-3	
		6305	1.92/60	192/2-7	
		6306	1.92/60	192/2-4	
		6307	1.92/60	192/2-4	
		6308	1.92/70	192/2-4	
		6309	1.92/70	192/2-4	
		6310**	1.92/70	192/2-4	
		6311***	1.92/70	192/2-4	
		6403	1.92/60	192/2-3	
		6404	1.92/70	192/2-3	
		6405	1.92/70	192/2-7	
		6406	1.92/70	192/2-7	
6407*	1.92/60	192/2-7			
1553550	1.92/12	Contents of set 1.92/1 and 1.92/2			7.6

1.92

PARTS

- Pulling legs No. 1.92/10 to 1.92/70 = set of 4 pieces
- For spindle 1.1406200: please also order adaptor 192/A-2

Code	No.	Description
1583263	1.92/10	Leg 120 mm
1583271	1.92/20	Leg 125 mm
1583298	1.92/30	Leg 130 mm
1583301	1.92/40	Leg 135 mm
1583328	1.92/50	Leg 140 mm
1583336	1.92/60	Leg 145 mm
1583344	1.92/70	Leg 150 mm
1574485	192/1-3	Head small 3
1574493	192/1-4	Head small 4
1574507	192/1-7	Head small 3/7
1574515	192/2-3	Head big 3
1574523	192/2-4	Head big 4
1574531	192/2-7	Head big 3/7
1574566	192/A-2	Adaptor for head big 1.92/2
1576208	1.1006170	Spindle small for 1.92/1
1576224	1.1406200	Spindle big for 1.92/2

**1.29****BALL BEARING EXTRACTOR**

- For removing ball bearings that are both on a shaft and in a housing
- The legs selected using the table are inserted into the ball race, evenly distributed in the outer ring according to the number of balls
- The support rings supplied for the ball bearings to be removed are placed on the bearings' inner races
- The hub with spindle is then placed on the centering depression of the shaft and the spindle put under tension with the legs
- Delivery contains head and spindle
- Please order suitable legs separately!



Code	No.	mm	mm	mm
8011000	1.29/1	M 10 x 160	14	0.2
8011190	1.29/2	M 12 x 195	14	0.5
8011270	1.29/3	M 14 x 210	17	0.6
8011350	1.29/4	M 18 x 230	19	0.9
8011430	1.29/5	M 20 x 235	22	1.9



Extracting without drilling open the ball bearing! Therefore no risk of any chippings in machines.

**1.29****PULLING LEGS 4 pieces**

- * Used with support rings for pulling bearings



Code	No.	mm	for hub	for ball bearing No.	mm
8011510	1.29/10	145	1.29/1	6000 6001 6002	80
8011780	1.29/15	145	1.29/1	6003 6004 6005 6200 6201 6202	100
8011860	1.29/20	177	1.29/2	6006 6203	200
8011940	1.29/25	177	1.29/2	6007 6008 6009 6010 6204 6205 6300 6301 6302	200
8012080	1.29/30	185	1.29/2 1.29/3	6303 6304 6206 6011 6012	300
8012160	1.29/35	187	1.29/3	6207 6208 6305	400
8012240	1.29/40	235	1.29/4	6209 6210 6306	600
8110250	1.29/45	236	1.29/4 1.29/5	6211 6212 6308* 6404 6405 6309* 6310* 6311* 6406*	800

1.29/K**BALL BEARING EXTRACTOR SET**

- In sheet metal case, dimensions: 285 x 190 x 75 mm







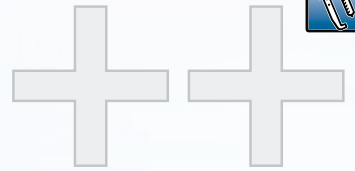







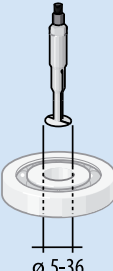
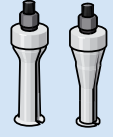
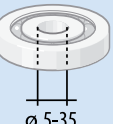
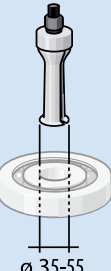
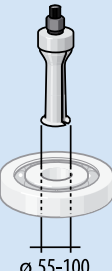
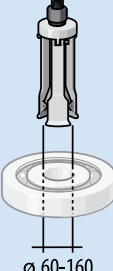
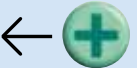
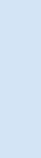
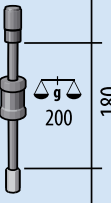



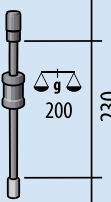



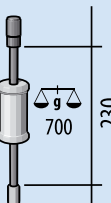

Code	No.	Contents	mm
8110330	1.29/1K	3 hubs with spindle 1.29/1 - 1.29/3 6 sets legs 1.29/10 - 1.29/35 1 plug-in handle 1.29/0	5.1
8012320	1.29/3K	5 hubs with spindle 1.29/1 - 1.29/5 8 sets legs 1.29/10 - 1.29/45 1 plug-in handle 1.29/0 and 4 support rings	8.7

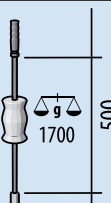
**1.85****379****5.10****379**

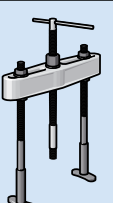
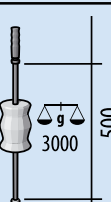

INTERNAL EXTRACTOR OVERVIEW

WITH MATCHING COUNTER-STAYS AND SLIDING HAMMERS

	No. 1.34/1-4	No. 1.30/0-5 No. 1.30/2N-3N	No. 1.30/6-7	No. 1.30/8-9	No. 1.30/10	
 	 ø 5-36	  ø 5-35	 ø 35-55	 ø 55-100	 ø 60-160	 
No. 1.35/0  180 200	 					 No. 1.36/1
No. 1.35/1  230 200						 No. 1.36/2
No. 1.35/1A  230 700						 No. 1.36/3
No. 1.35/2  500 1700						 No. 1.36/4
No. 1.35/3  500 3000						

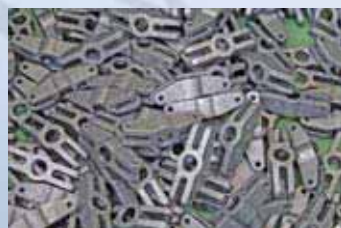



1.34 INTERNAL EXTRACTOR

In a class of its own due to the precision manufacturing technology

Contents:



1.34/10 - 5-piece internal extractor set for closely-fitting ball bearings
Attractive set arrangement
Can be used with sliding hammer or counter-stay



1.34 Internal extractor



Higher spread range

3 Force transmission is increased and improved by precise manufacturing accuracy.



1 The simple handling method guarantees the fast and uncomplicated withdrawal of ball bearings.

2 Because of their titanium nitrided coating the surfaces have increased hardness and are provided with better protection.

4 The expansion ranges have been increased, thus fewer pullers are necessary for the same overall expansion range.

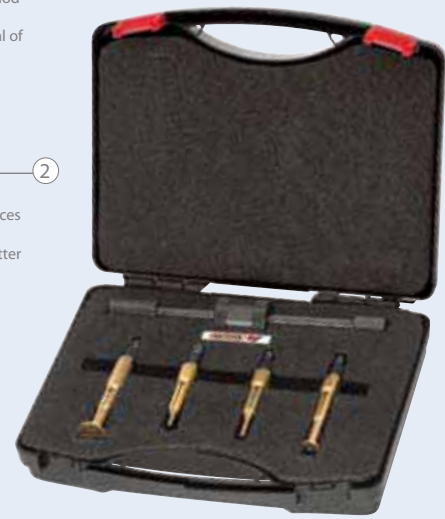

FEATURES MATERIAL

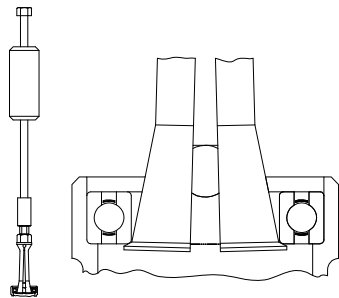

ADVANTAGES TITANIUM NITRIDED SURFACE

- ▶ Harder
- ▶ More wear-resistant
- ▶ Better surface protection
- ▶ More heat-resistant
- ▶ Fine design
- ▶ Fast compensation of temperature differences



1.34/1 - 1.34/4

INTERNAL EXTRACTOR

- ▶ For use with impact bearing puller no. 1.35/0 or support brace no. 1.36/1
- ▶ Multiple wrench size (11+ 13 mm)



Code	No.	M	Ø mm	mm
1638556	1.34/1	M10	5,0-8,5	40
1638564	1.34/2	M10	8,0-15,0	60
1638572	1.34/3	M10	15,0-25,0	80
1638580	1.34/4	M10	25,0-36,0	100

1.34/10

INTERNAL EXTRACTOR SET 5 pieces

- ▶ For tightly-fitting ball bearings, bearing races, bushings and shaft seals
- ▶ Titanium-nitrided surface
- ▶ Operation: The internal extractor is inserted into the bearing and the spindle screwed in. The sharp turned-out shoulders of the pulling shell jaws will press outwards behind the part to be extracted. The counter-support brace or the impact bearing puller is then added.

Contents in practical case:

- ▶ 4 internal extractors:
 - ▶ 1.34/1 (5-8.5 mm)
 - ▶ 1.34/2 (8-15 mm)
 - ▶ 1.34/3 (15-24 mm)
 - ▶ 1.34/4 (25-36 mm)
- ▶ 1 impact bearing puller 1.35/0
- ▶ Multiple wrench size (11+13 mm)
- ▶ M10 connecting thread



Code	No.	mm
1638629	1.34/10	1.3



1.30/0-9

INTERNAL EXTRACTOR

- For extremely-tightly-packed ball bearings, bearing races, bushings, and shaft seals Simmering®
- Operation: The internal extractor is inserted into the bearing and the spindle screwed in. The sharp turned-out shoulders of the pulling shell jaws will press outwards behind the part to be extracted. The counter-support brace is then added. Both feet must be aligned parallel to the spindle to ensure rigidity.



Code	No.	M	t	mm	mm	mm
8012750	1.30/0	M10	1.36/1	5-8	10	120
8012830	1.30/1	M10	1.36/1	8-12	10	120
8012910	1.30/2	M10	1.36/1	12-15	10	130
8013130	1.30/3	M10	1.36/1	15-19	13	170
8013480	1.30/4	M10	1.36/1	19-25	13	200
8013560	1.30/4A	M10	1.36/1	25-30	13	300
8013640	1.30/5	M10	1.36/1	30-35	13	400
8013720	1.30/6	M14x1,5	1.36/2	35-45	17	650
8013800	1.30/7	M14x1,5	1.36/2	45-55	17	800
8013990	1.30/8	M14x1,5	1.36/3	55-70	19	1800
8014020	1.30/9	M14x1,5	1.36/3	70-100	27	3050

1.30/N

INTERNAL EXTRACTOR with reinforced shoulder

- Especially suitable for the safe and trouble-free extraction of needle roller bearings, ball bearings and brass sleeves from crankshafts
- Note: The shoulder of the shell jaw must be applied behind the bearing



Code	No.	M	mm	mm	mm
8013050	1.30/2N	M10	12-14	10	170
8013210	1.30/3N	M10	14-19	13	170

1.30/10

INTERNAL EXTRACTOR

- Suitable for removing large ball bearings and bearing outer races
- Operation: The extraction jaws are spread by turning the nut. The newly-developed spreading system enables a simple, step-free and time-saving adjustment to the desired diameter to be made. The sharp-edged sections of the extraction jaws seat flush beneath when spread



Code	No.	M	mm	mm	mm
8014100	1.30/10	G 1/2"	60-160	36	2312



BALL BEARING EXTRACTED?



Fit a new one with our 1.85 bearing installation tool set!



379



www.gedore.com



1.35

IMPACT BEARING PULLER

► Suited for the removal of small ball bearings since there is often not enough room for support braces

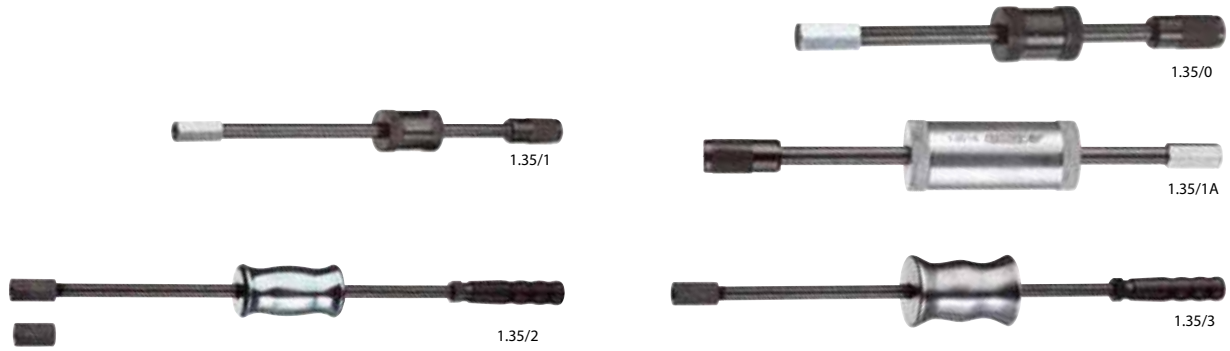

Code	No.	for internal extractors	mm	with adaptor	mm	mm	Impact weight in g	kg
1958062	1.35/0	1.34/1 - 1.34/4	M10	-	13	180	200	400
8016070	1.35/1	1.30/0 - 1.30/5 1.34/1 - 1.34/4	M10	-	13	230	200	450
1958070	1.35/1A	1.30/0 - 1.30/7	M10	M 14x1,5	13	230	700	950
8039010	1.35/2	1.30/0 - 1.30/9	M 14x1,5	M10	24	500	1700	3200
1958089	1.35/3	1.30/6 - 1.30/10	M 14x1,5	-	24	500	3000	4200

1.36

SUPPORT BRACE

► Operation: The support brace is placed on the housing and the spindle screwed onto the spindle of the internal extractor. The toggle is held firmly, and the bearing extracted by tightening the nut.



Code	No.	for internal extractors	mm	mm	kg
8016580	1.36/1	1.30/0 - 1.30/5 1.34/1 - 1.34/4	M10	27	750
8016660	1.36/2	1.30/6 - 1.30/7	M14x1,5	32	1650
8016740	1.36/3	1.30/8 - 1.30/9	M14x1,5	32	3000
8016820	1.36/4	1.30/10	G 1/2"	36	7600

Deviant packing units see article description.



1.37

CYLINDER LINER PULLER complete with support brace

► Wet heavy-vehicle (e.g. Mercedes Benz, MAN) cylinder liners, automobile and stationary-engine liners, and other parts may be extracted using this puller

► Operation: The spindle of the support brace is screwed into the clamping nut of the puller, and the puller inserted into the liner. The support brace is placed on to the cylinder block. Due to the newly-developed spreading system, when the spindle is turned, all three jaws spread quickly and without difficulty, until they are firmly seated beneath the edge of the liner. Then the nut of the support brace is tightened.



Code	No.	mm	mm	mm	kg
8017200	1.37/2	G 1/2"	60-160	36	6.8

1.31

INTERNAL EXTRACTOR SET

- ✔ Sets comprise the most used extractor sizes for the removal of ball bearings, bearing races, bushings, shaft seals, etc.
- ✔ In handy sheet metal case



1.31/2



1.31/0



Code	No.	Contents	
8014450	1.31/0N	4 internal extractors 12-30 mm 1.30/2N -3N -4 -4A 1 support brace 1.36/1	2.6
8014530	1.31/0	4 internal extractors 12-30 mm 1.30/2 -3 -4 -4A 1 support brace 1.36/1	2.6
8014610	1.31/1	6 internal extractors 12-46 mm 1.30/2 -/6 2 support braces 1.36/1 - /2	6.4
8014880	1.31/2	8 internal extractors 12-70 mm 1.30/2 -/8 2 support braces 1.36/1 - /2	9.2

1.32/1-2

SET OF INTERNAL AND EXTERNAL EXTRACTORS

- ✔ The handy sheet metal case comprises internal extractors, support braces, pulling chucks, external extractors and stud extractors



1.32/1



1.32/2



1.32/2

Code	No.	Contents	
8015260	1.32/1	6 internal extractors 12-46 mm 1.30/2 -/6, 2 support braces 1.36/1 -/2, 1 puller with extra slim legs 1.19/OXS 1 battery-terminal puller 1.12/02, 1 puller, 2-arm pattern 1.06/1	10.4
8015340	1.32/2	8 internal extractors 12-70 mm 1.30/2 -/8, 2 support braces 1.36/1 -/2, 1 puller with extra slim legs 1.19/OXS 1 battery-terminal puller 1.12/02, 2 pullers, 2-arm pattern 1.06/1 /2, 1 stud extractor 1.28/1	19.0



WHEEL-HUB PULLERS

1.60

WHEEL-HUB PULLER for cars and trucks

- For wheel stud circles up to 225 mm
- Easy to use
- Upgradeable with hydraulic spindle (see table)
- No. 1.60/H = Spare leg



Code	No.	No. of legs			
8024840	1.60/3	3	G 3/4 x 200	1.06/HSP2	4.3
8110840	1.60/4	4	G 3/4 x 200	1.06/HSP2	4.9
8024920	1.60/5	5	G 3/4 x 200	1.06/HSP2	5.3
8110920	1.60/H	1			0.5

1.60/HSP

WHEEL-HUB PULLER for cars and trucks, hydraulic (not illustrated)

- For wheel stud circles up to 225 mm
- Easy to use

Code	No.	No. of legs			
8015690	1.60/3-HSP2	3		1.06/HSP2	4.5
8015770	1.60/4-HSP2	4		1.06/HSP2	5.4
8015850	1.60/5-HSP2	5		1.06/HSP2	5.8

1.61

WHEEL-HUB PULLER for cars and trucks

- For wheel stud circles up to 250 mm
- Easy to use
- Upgradeable with hydraulic spindle (see table)
- No. 1.61/H = Spare leg



Code	No.	No. of legs			
8111060	1.61/3	3	G 3/4 x 200	1.06/HSP2	4.7
8111140	1.61/4	4	G 3/4 x 200	1.06/HSP2	5.2
8025300	1.61/5	5	G 3/4 x 200	1.06/HSP2	5.8
8111220	1.61/H	1			0.6

1.61/HSP

WHEEL-HUB PULLER for cars and trucks, hydraulic

- For wheel stud circles up to 250 mm
- Easy to use
- With wheel stud protection using rotating nut apertures that always lie flat to the hub



Code	No.	No. of legs			
8015930	1.61/3-HSP2	3		1.06/HSP2	5.4
8016150	1.61/4-HSP2	4		1.06/HSP2	6.2
8016230	1.61/5-HSP2	5		1.06/HSP2	6.9

1.62

WHEEL-HUB PULLER for trucks

- For wheel stud circles up to 350 mm
- With wheel stud protection using rotating nut apertures that always lie flat to the hub
- This tool may also be used with the hydraulic aid without requiring a reduction bushing
- Upgradeable with hydraulic spindle (see table)



Code	No.	No. of legs			
8026030	1.62/8	8	G 1 x 310	1.06/HSP3	12.6
8111220	1.61/H	1			0.6

1.62/HSP

WHEEL-HUB PULLER for trucks, hydraulic (not illustrated)

- For wheel stud circles up to 350 mm
- With wheel stud protection using rotating nut apertures that always lie flat to the hub

Code	No.	No. of legs			
8016310	1.62/8-HSP3	8		1.06/HSP3	13.6



BALL JOINT PULLER

1.73 - PARTNER TO RELY ON FOR YOUR VEHICLE

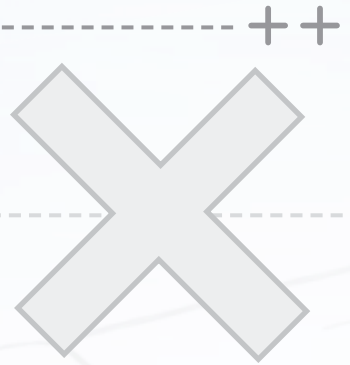
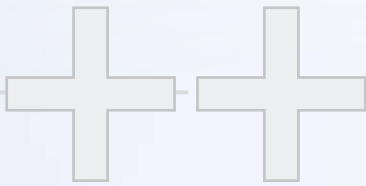

Body and lever of the 1.73 ball joint puller are drop-forged from 31CrV3 tempering steel and then hardened and tempered. In this way, the two major parts acquire the needed hardness and stability.

Using the spindle, the ball joint puller is brought up to the required clamping height.

The set bolt applies that force needed to press out the ball joint. To withstand a load like this, the thread is rolled followed by hardening and tempering the spindle.



Article 1.73 comes in two sizes which together with their dimensions cover the most common pressure/force situations. Other dimensions are covered by articles 1.72 and 1.74 - the compact 1.72 can be made use of, for instance, in extremely tight spots.

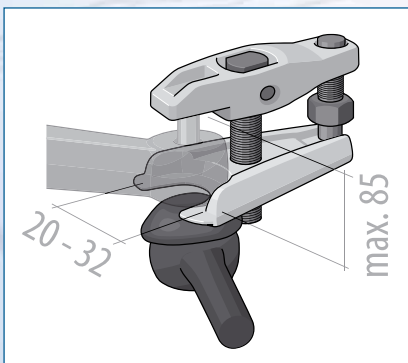

SAFETY-RELEVANT

Forces amounting to several tons in weight act on the puller during the extracting operation! Drop-forged components "announce" possible overloading by bending. This is due to the fibre course of the material during forging permitting a certain flexibility of the components ahead of fracturing - an extremely "healthy" property, in fact!

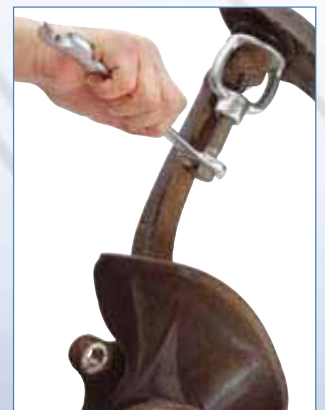



BALL JOINT PULLERS

1.72

BALL JOINT PULLER

- For the simple and damage-free removal of ball pins on track rods and push rods

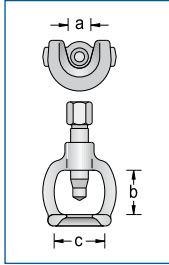

Code	No.	a	b	c	—mm—	●mm	↔mm
8030300	1.72/1	18	35	40	M 14x1,5 x 50	17	0.3
8030490	1.72/2	23	45	50	M 14x1,5 x 50	17	0.4
8030570	1.72/3	27	56	60	M 18x1,5 x 80	19	0.7
8030650	1.72/4	37	78	75	G 1/2 x 110	22	1.7
2183323	1.72/4A	40	80	80	G 1/2 x 140	22	2.2
2183331	1.72/5A	46	100	90	G 3/4 x 160	27	2.8

1.73

UNIVERSAL BALL JOINT PULLER

- For removing ball joints on cars and trucks



Code	No.	mm □	Clamping height	Fork depth	↔mm
8030810	1.73/1	23	65	24	0.7
8033240	1.73/3	32	85	28	2.5

1.74

UNIVERSAL BALL JOINT PULLER

- For removing the ball joint journals on track rods, stabilizers, etc.
- Simple operation due to slender lower part and 2-stage lever position



Code	No.	mm □	Clamping height	Fork depth	↔mm
8085200	1.74/1	20	12-50	35	1.4
8085390	1.74/2	20	50-80	35	1.7

OIL FILTER HOOK

1.75

OIL FILTER HOOK 3-arm pattern

- For removing firmly seated oil filters
- With 3/8" female square drive and adaptor 17 mm external

3/8"

Code	No.	mm □	↔mm
8117420	1.75/1	60-120	0.7

1.76

CARTRIDGE SPANNER 3-arm pattern

- For tightening and removing
- Especially suitable for removing firmly seated granulate cartridges of compressed air dryers on HGV, e.g. Mercedes Benz, MAN, etc.
- Great clamping reach (from 95 to 165 mm)
- The GEDORE cartridge spanner is also usable as oil filter key
- Zinc-plated
- Drive 1/2"

12,5**1/2"**

Code	No.	□"	□	mm □	↔mm
1523651	1.76/1	1/2	12.5	95-165	1.420





1.64

DRIVE SHAFT PULLER

- ✔ Suitable for drive shafts with 4 or 5 apertures
- ✔ For wheel stud circles 100-155 mm with 6 mm screws
- ✔ For tapped holes up to max. M14
- ✔ **Operation:** The puller is attached to the drive shaft flange using the nuts of the wheel bolts. By striking the spindle head with the sliding hammer, the shaft may be removed easily and without damage.



Code	No.	● mm	↔
8026700	1.64/1	24	4.5

1.65

PULLING FLANGE heavy-duty pattern

- ✔ For wheels and discs with tapped holes up to M16
- ✔ The flange is fitted with slots for hole pitches of 180, 120, and 90 degrees
- ✔ Additional holes may be drilled to render the flange suitable for other pitches and aperture diameters
- ✔ A very sturdy model for heavy parts and the highest requirements



Code	No.	↔	↔
8027000	1.65/1	G 1.1/4 x 270	16.0

1.66

PULLING FLANGE

- ✔ For wheels and discs with tapped holes up to M10
- ✔ The flange is fitted with slots for hole pitches of 180 and 120 degrees
- ✔ Steering wheel puller no. 1.66/11 with one pair each of long (135 mm) and short (85 mm) hooks and a protective cap for the thread of the steering column



Code	No.	↔	● mm	↔
8027510	1.66/1	M 12 x 110	14	0.7
8027780	1.66/11	M 12 x 110	14	1.1

1.67

STEERING-WHEEL PULLER for cars

- ✔ Contains 1 pair of short legs, 1 pair of long legs, and a protective cap for the thread of the steering column



Code	No.	Clamping reach	Leg length up to	↔	● mm	↔
8028240	1.67/1	35-90	135	M 14x1,5 x 150	17	0.9

1.68

STEERING-WHEEL PULLER

- ✔ Featuring 1 pulling ring each with 100 mm and 150 mm diameter for 3-spoke and 4-spoke steering wheels
- ✔ To protect the steering-wheels, the pulling rings are fitted with sliding rubber sleeves



Code	No.	Leg length	↔	● mm	↔
8028750	1.68/1	120	M 18 x 170	19	2.0

1.70

DISMANTLING AND ASSEMBLY FORK

- ✔ For fast removal of track rod and push rod ends, steering arms, and other steering parts
- ✔ Also suitable for removing shock absorbers and other separating and dismantling work
- ✔ The forks are suitable for use in the most confined spaces
- ✔ Hammer blows on the handle ends are used to separate the parts

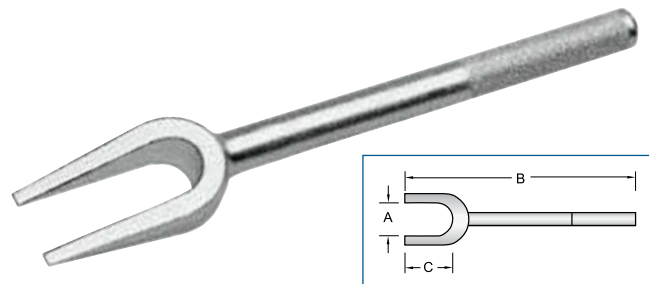

Code	No.	A	B	C	↔
8029210	1.70/1	18	340	80	0.8
8029480	1.70/2	23	340	80	0.9
8029560	1.70/3	29	350	90	1.1
8029640	1.70/4	40	350	90	1.2
8085040	1.70/5	45	355	95	1.2



TRACK ALIGNMENT GAUGE

3.01

TRACK ALIGNMENT GAUGE

- For inside measurement
- Suitable for all vehicle types
- With simple, telescopic length adjustment
- Immediate track-difference readings may be taken from the millimetre scale
- Extensive measurement range from 835 to 1500 mm, and with extensions up to 2100 mm
- Track difference measurable from 0-35 mm
- Notes on Use: The vehicle to be tested must be standing on level ground. The front wheels must be set for running straight ahead and have the same tyre pressure. The play in the steering linkage must be removed by pressing the front wheels apart. The track alignment gauge must be set roughly at the axle centre-line between the front tyres in such a manner that the two chain ends contact the ground. The scale is set a "0". The car is allowed to roll forward approx. one half turn of the wheel, until the chain ends again contact the ground. The track difference may then be read off on the scale.

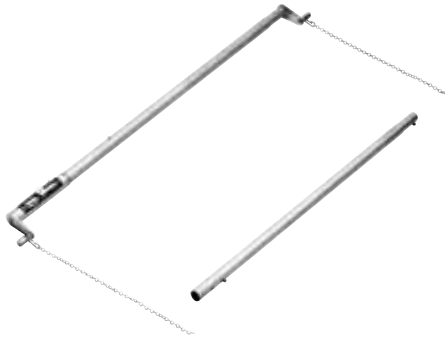

Code	No.	Description	Measurement range mm	
8033080	3.01	Track alignment gauge 835-1500 mm	835-1500	1.9
8033160	3.01/V	Extension for track alignment gauge 1500-2100 mm	1500-2100	0.6



NOTES ON USE 3.01

The vehicle to be tested must be standing on level ground. The front wheels must be set for running straight ahead and have the same tyre pressure. The play in the steering linkage must be removed by pressing the front wheels apart. The track alignment gauge must be set roughly at the axle centre-line between the front tyres in such a manner that the two chain ends contact the ground. The scale is set a "0". The car is allowed to roll forward approx. one half turn of the wheel, until the chain ends again contact the ground. The track difference may then be read off on the scale.

SPRING COMPRESSOR

1.78/S

SAFETY COIL SPRING COMPRESSOR

- For the safe installation and removal of coil springs with a diameter of 110-180 mm
- Safety note:** When the spindles are tightened evenly, the clamping heads grip the coils tightly, rendering sideways slip impossible
- VPA-GS-tested safety

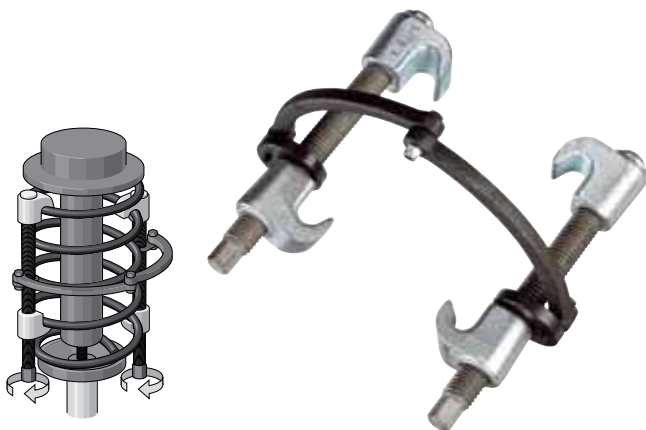

Code	No.	Clamping reach	
8031110	1.78/S1	140	1.8
8031380	1.78/S2	240	2.2
8031460	1.78/S3	340	2.6

1.78/P

UNIVERSAL COIL SPRING COMPRESSOR

- For MacPherson suspension strut and transverse link axes with spring diameters of 110-180 mm
- The hooks are drop forged
- The wide support rests are matched to the coil spring pitch
- VPA-GS-tested safety
- PK = with plastic cap



Code	No.	Clamping reach	max. t	
8111300	1.78/P1	240	3.5	2.6
8031030	1.78/PK1	240	3.5	2.5



1.79

SPRING SPREADER

- Especially designed for VAG exhaust installations, where the pipe is not held by bolts to the exhaust manifold, but clamped on using springs



Code	No.	
8112540	1.79/1	0.4

1.91

TYRE REMOVING TOOL

- For breaking the adhesion between truck tyres and wheel rims



Code	No.	l-mm	
8032270	1.91	300	2.0



ACCESSORIES

1.26

NUT SPLITTER

- For splitting jammed or stripped nuts without damaging the bolt thread
- Suitable for nuts up to property class 6



Code	No.	for nuts	mm	mm	mm
8009880	1.26/1	10-17 mm, M6-M10	M 14x1,5 x 37	17	0.3
8009610	1.26/2	17-24 mm, M10-M16	M 14x1,5 x 37	17	0.3
8010030	1.26/3	24-36 mm, M16-M24	M 22x1,5 x 70	24	1.1

Code	No.	Description	mm
2017016	1.26/M1	Spare chisel for 1.26/1 + /2	0.0
2017024	1.26/M3	Spare chisel for 1.26/3	

1.26/K

NUT SPLITTER SET

- For nuts from size 10 mm (M6) to size 36 mm (M24) including spare chisel
- In plastic case with Check-Tool insert



Code	No.	Contents	mm
2017008	1.26/K-3	as below stated	2.5

Code	No.	Description	Qty.
8009880	1.26/1	Nut splitter 10-17 mm, M6-M10	1
8009610	1.26/2	Nut splitter 17-24 mm, M10-M16	1
8010030	1.26/3	Nut splitter 24-36 mm, M16-M24	1
2017016	1.26/M1	Spare chisel for 1.26/1 + /2	2
2017024	1.26/M3	Spare chisel for 1.26/3	1

1.26/HYD

NUT SPLITTER hydraulic

- With strong chisel, additionally induction hardened
- At the cutting edge for breakage resistance
- The chamfer at the chisel's edge improves the splitting effect and prevents breakage
- With smooth chisel function
- Channel walls rolled, thus mirror-smooth and wear resistant
- For nuts up to property class 10
- Chisel replaceable

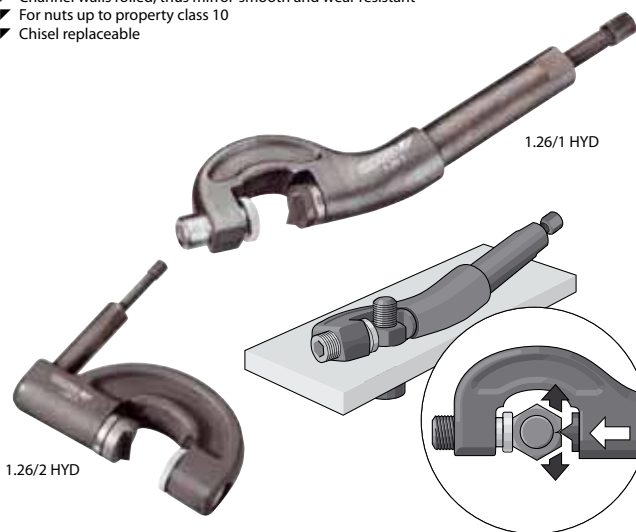

Code	No.	for nuts	mm	max. t	mm
8009450	1.26/1 HYD	7-22 mm, M4-M14	12	5.0	0.8
8009530	1.26/2 HYD	22-36 mm, M14-M24	12	13.0	3.4

Code	No.	Description	mm
2018586	1.26/M1 HYD	Spare chisel for 1.26/1 HYD	0.0
2043920	1.26/M2 HYD	Spare chisel for 1.26/2 HYD	0.1

1.28

STUD EXTRACTOR

- For inserting and removing studs
- Even suitable for extremely short stud ends

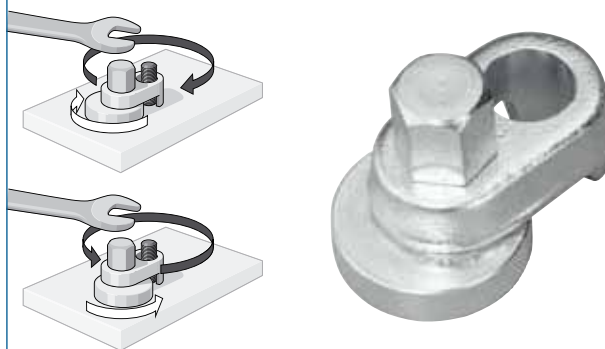

Code	No.	Ø-Stud	mm	mm
8010620	1.28/1	6-13	19	0.2
8010700	1.28/2	8-19	19	0.3
8010890	1.28/3	19-25	19	0.4

1.28/4

STUD EXTRACTOR

- For inserting and removing studs
- Even suitable for extremely short stud ends



Code	No.	Ø-Stud	mm	mm
1465031	1.28/4	5-26	19	0.6

**1.44****PULLING CHUCK**

- For removing the inner races of dynamos, magnetos, motors, and other machine parts
- Simple operation by tightening the cap nut



Code	No.	Clamping reach	Clamping depth	
8022040	1.44/1	5-32	125	1.4

1.90**FLANGE SEPARATORS (pair)**

- For separating DIN standard flanges on pipes when changing seals and doing maintenance work
- For Ø 80-250 mm and screw threads M16-M24
- Use: Always use the separators in pairs and attach them to opposite sides of the flange. When the two spindles are turned alternately, the flanges will be separated from one another evenly. When the spindles are turned back alternately, this guarantees a perfect fitting of the flanges in their original position. Always use in pairs! Press in opposite directions at 180°!



Code	No.	for screw threads	Ø	
1596403	1.90/1	M16 - M24	80-250	5.5

1.81/1 + 2**SET OF THREADED INSERTS for 1-hole uses**

- The threaded inserts make the removal of threaded caps, for example, possible, when these possess one threaded hole
- No. 1.81/1: For slide hammers 1.35/1, 1.35/2, threaded support 1.36/1
- No. 1.81/2: For slide hammers 1.35/2, 1.36/2, threaded support 1.36/3

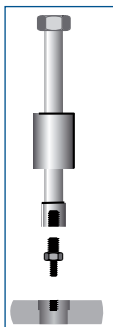

Code	No.	Connecting thread	
1120727	1.81/1	M10 - M4 M10 - M5 M10 - M6 M10 - M8 M10 - M10 M10 - M12	340
1120743	1.81/2	M14x1,5 - M8 M14x1,5 - M10 M14x1,5 - M12 M14x1,5 - M14 M14x1,5 - M16 M14x1,5 - M18	490

1.81/10 + 20**SET OF THREADED INSERTS for 1-hole and 2-hole uses, 2 each**

- The threaded inserts make the removal of threaded caps, for example, possible, when these possess one or two threaded holes
- No. 1.81/10: For separator puller 1.38/0, 1.38/1
- No. 1.81/20: For separator puller 1.38/2



Code	No.	Connecting thread	
1120735	1.81/10	M10 - M4 M10 - M5 M10 - M6 M10 - M8 M10 - M10 M10 - M12	670
1120751	1.81/20	M14x1,5 - M8 M14x1,5 - M10 M14x1,5 - M12 M14x1,5 - M14 M14x1,5 - M16 M14x1,5 - M18	1222

1.81/K**SET OF THREADED INSERTS for 1-hole uses**

- The threaded inserts make the removal of threaded caps, for example, possible, when these possess one threaded hole
- No. 1.81/K-1: With slide hammer 1.35/1, rod 230 mm and impact weight 200 g
- No. 1.81/K-12: With slide hammer 1.35/1A, rod 230 mm and impact weight 700 g, adaptor M14x1,5
- No. 1.81/K-112: With slide hammer 1.35/1A, rod 230 mm, impact weight 200 + 700 g, adaptor M14x1,5
- In robust plastic case, 275 x 229 x 83 mm

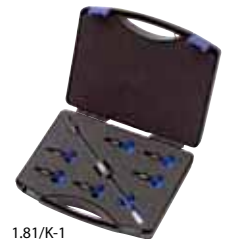
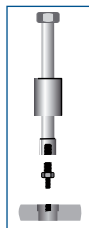

Code	No.	Connecting thread	
1936549	1.81/K-1	M10 - M4 M10 - M5 M10 - M6 M10 - M8 M10 - M10 M10 - M12	1000
1936557	1.81/K-12	M10 - M4 M10 - M5 M10 - M6 M10 - M8 M10 - M10 M10 - M12 M14x1,5 - M14 M14x1,5 - M16 M14x1,5 - M18	1830
2142902	1.81/K-112	M10 - M4 M10 - M5 M10 - M6 M10 - M8 M10 - M10 M10 - M12 M14x1,5 - M14 M14x1,5 - M16 M14x1,5 - M18	2030

**1.35 • 1.36****397**



ADD-ON SYSTEMS

1.18/1.19

PULLER SET

- ✔ This perforated panel offers place for 12 pullers of the series 1.18 and 1.19



Code	No.	Contents 1 each	
1824007	1.18/1.19	2-arm Puller 1.18/1 1.18/2 1.18/3 3-arm Puller 1.19/1 1.19/2 1.19/3 2-arm-Fan puller 1.18/0 1.18/01 1.18/02 3-arm Fan puller 1.19/0 1.19/01 1.19/02	21.0

2.10

AUTOMOBILE WORKSHOP SET Add-on system

- ✔ Clearly arranged module system
- ✔ Everything at hand on perforated wall-board



Code	No.	Contents	
1088696	2.10	as below stated	13.3

Code	No.	Description	Qty.
1076469	106/103	Cross-beam, 2-arm pattern, 140 mm	1
1076981	107/103	Cross-beam, 3-arm pattern, 140 mm	1
1120514	106/A-100-N	Pulling leg, 100 mm	3
1175343	106/S100	Pulling leg, slim pattern, 100 mm	3
8003840	1.12/02	Battery-terminal puller, 2-arm pattern 60x40 mm	1
8009610	1.26/2	Nut splitter 17-24 mm, M10-M16	1
8010700	1.28/2	Stud extractor 8-19 mm	1
8029480	1.70/2	Dismantling and assembly fork 23 mm	1
8030810	1.73/1	Universal ball joint puller 65 mm / 20 mm	1
8117420	1.75/1	Oil filter hook 3-arm pattern 60-120 mm	1

2.20

TRUCK WORKSHOP SET Add-on system

- ✔ Clearly arranged module system
- ✔ Everything at hand on perforated wall-board



Code	No.	Contents	
1088718	2.20	as below stated	23.3

Code	No.	Description	Qty.
1076612	106/2A03	Cross-beam, 2-arm pattern, 260 mm	1
1077023	107/2A03	Cross-beam, 3-arm pattern, 260 mm	1
1120530	106/B-150-N	Pulling leg, 150 mm	3
1175475	106/S220	Pulling leg, slim pattern, 220 mm	3
1123947	106/B-300-N	Pulling leg, 300 mm	3
1084593	1.2106210	Spindle 22 mm, G 1/2", 210 mm	1
8116100	1.06/HSP1	Hydraulic pressure spindle 10 t	1
8019840	1.40/2	Bearing separator 22-115 mm	1

2.30

INDUSTRIAL PULLING SET Add-on system

- ✔ For the assembly of the tried and tested 1.06 and 1.07 versions
- ✔ Using this set, you will be able to assemble more than 12 of the usual versions with high-speed clamping legs, including hydraulic spindle, in seconds



Code	No.	Contents	
1393014	2.30	as below stated	19.4

Code	No.	Description	Qty.
1076469	106/103	Cross-beam, 2-arm pattern, 140 mm	1
1076485	106/1A03	Cross-beam, 2-arm pattern, 180 mm	1
1076590	106/203	Cross-beam, 2-arm pattern, 220 mm	1
1076612	106/2A03	Cross-beam, 2-arm pattern, 260 mm	1
1076981	107/103	Cross-beam, 3-arm pattern, 140 mm	1
1077007	107/1A03	Cross-beam, 3-arm pattern, 180 mm	1
1077015	107/203	Cross-beam, 3-arm pattern, 220 mm	1
1077023	107/2A03	Cross-beam, 3-arm pattern, 260 mm	1
1084488	1.1406140	Spindle 17 mm, M14x1.5, 140 mm	1
1084593	1.2106210	Spindle 22 mm, G 1/2", 210 mm	1
8116100	1.06/HSP1	Hydraulic pressure spindle 10 t	1
1178199	106/A-100-E	Quick-release pulling leg 100 mm	3
1178253	106/B-150-E	Quick-release pulling leg 150 mm	3



2.30-B

INDUSTRIAL PULLING SET WITH LEG BRAKE Add-on system

- For the assembly of the tried and tested 1.06 and 1.07 versions
- Using this set, you will be able to assemble more than 12 of the usual versions with high-speed clamping legs, including hydraulic spindle, in seconds
- 2-arm cross-beams with scale for uniform adjustment of the puller legs. Allows centred pulling, with optimised application of force, even when extremely high pulling forces are required
- Leg brake prevents unintentional leg slipping. The leg can be slid along the cross-beam at the push of a button



Code	No.	Contents	🚚
2017032	2.30-B	as below stated	19.4

Code	No.	Description	Qty.
1076469	106/103	Cross-beam, 2-arm pattern, 140 mm	1
1076485	106/1A03	Cross-beam, 2-arm pattern, 180 mm	1
1076590	106/203	Cross-beam, 2-arm pattern, 220 mm	1
1076612	106/2A03	Cross-beam, 2-arm pattern, 260 mm	1
1076981	107/103	Cross-beam, 3-arm pattern, 140 mm	1
1077007	107/1A03	Cross-beam, 3-arm pattern, 180 mm	1
1077015	107/203	Cross-beam, 3-arm pattern, 220 mm	1
1077023	107/2A03	Cross-beam, 3-arm pattern, 260 mm	1
1084488	1.1406140	Spindle 17 mm, M14x1.5, 140 mm	1
1084593	1.2106210	Spindle 22 mm, G 1/2", 210 mm	1
8116100	1.06/HSP1	Hydraulic pressure spindle 10 t	1
1970534	106/A-100-B	Pulling leg, all steel, leg brake, 100 mm	3
1970542	106/B-150-B	Pulling leg, all steel, leg brake, 150 mm	3

2.40

PULLING SET FOR CONSTRUCTION MACHINES Add-on system

- For the assembly of the robust and handy strap-pattern pulling tools 1.14 and 1.15
- With this set, you will be able to assemble 10 of the usual flexible strap-pattern pulling tools from the range 1.14/1.15, including the new hydraulic spindle



Code	No.	Contents	🚚
1393030	2.40	as below stated	24.3

Code	No.	Description	Qty.
1077856	114/204	Head	1
1077910	114/304	Head	1
1078054	115/204	Head	1
1078070	115/304	Head	1
1084569	1.1806200	Spindle 19 mm, M18x1.5, 200 mm	1
1084631	1.2106250	Spindle 22 mm, G 1/2", 250 mm	1
8116100	1.06/HSP1	Hydraulic pressure spindle 10 t	1
1077821	114/201	Pulling leg, 210 mm	3
1077899	114/301	Pulling leg, 260 mm	3
1077953	114/401	Pulling leg, 390 mm	3
1077872	114/208	Strap	6
1077937	114/308	Strap	12

Deviant packing units see article description.

2.50

SET OF INTERNAL AND EXTERNAL EXTRACTORS

- Suitable for various applications of external or internal extraction
- Internal extractors for bores with \varnothing 5 - 55 mm. To use in connection with impact bearing puller or counter-support braces
- External extractors with various clamping depths up to 130 mm
- Separators and pullers incl. extension rods, ideal for removing tightly-seated or thin-walled parts for outer diameter 5 - 115 mm



Code	No.	Contents	🚚
2017040	2.50	as below stated	29.0

Code	No.	Description	Qty.
8012750	1.30/0	Internal extractor 5-8 mm	1
8012830	1.30/1	Internal extractor 8-12 mm	1
8012910	1.30/2	Internal extractor 12-15 mm	1
8013130	1.30/3	Internal extractor 15-19 mm	1
8013480	1.30/4	Internal extractor 19-25 mm	1
8013560	1.30/4A	Internal extractor 25-30 mm	1
8013640	1.30/5	Internal extractor 30-35 mm	1
8013720	1.30/6	Internal extractor 35-45 mm	1
8013800	1.30/7	Internal extractor 45-55 mm	1
1958070	1.35/1A	Impact bearing puller 230 mm, 700 g	1
8039010	1.35/2	Impact bearing puller 500 mm, 1,7 kg	1
8016580	1.36/1	Support brace	1
8016660	1.36/2	Support brace	1
1868152	1.04/HP1A	Universal puller HIGH POWER 2-arm pattern 130x100 mm	1
1628410	1.13/00	Battery-terminal puller, 3-arm pattern 70x80 mm	1
8084580	1.23/15	Puller 80x85 mm	1
8017550	1.38/0	Separator puller	1
8017710	1.38/2	Separator puller	1
8018440	1.38/AV	Extension rod M10	1
8018520	1.38/CV	Extension rod M14x1.5	1
8019680	1.40/0	Bearing separator 5-60 mm	1
8019840	1.40/2	Bearing separator 22-115 mm	1



++ MANUAL HEAVY-DUTY PULLERS -----

- ▶ The 2- and 3-arm pullers are suitable for the removal of ball bearings, pulleys, wheels, and other close-fitting components
- ▶ Cage and T-handle enable easy and fast operation - opening, closing, locking and aligning of the legs by simply turning the T-handle
- ▶ The product range offers a wide variety of clamping widths and depths, and load limits

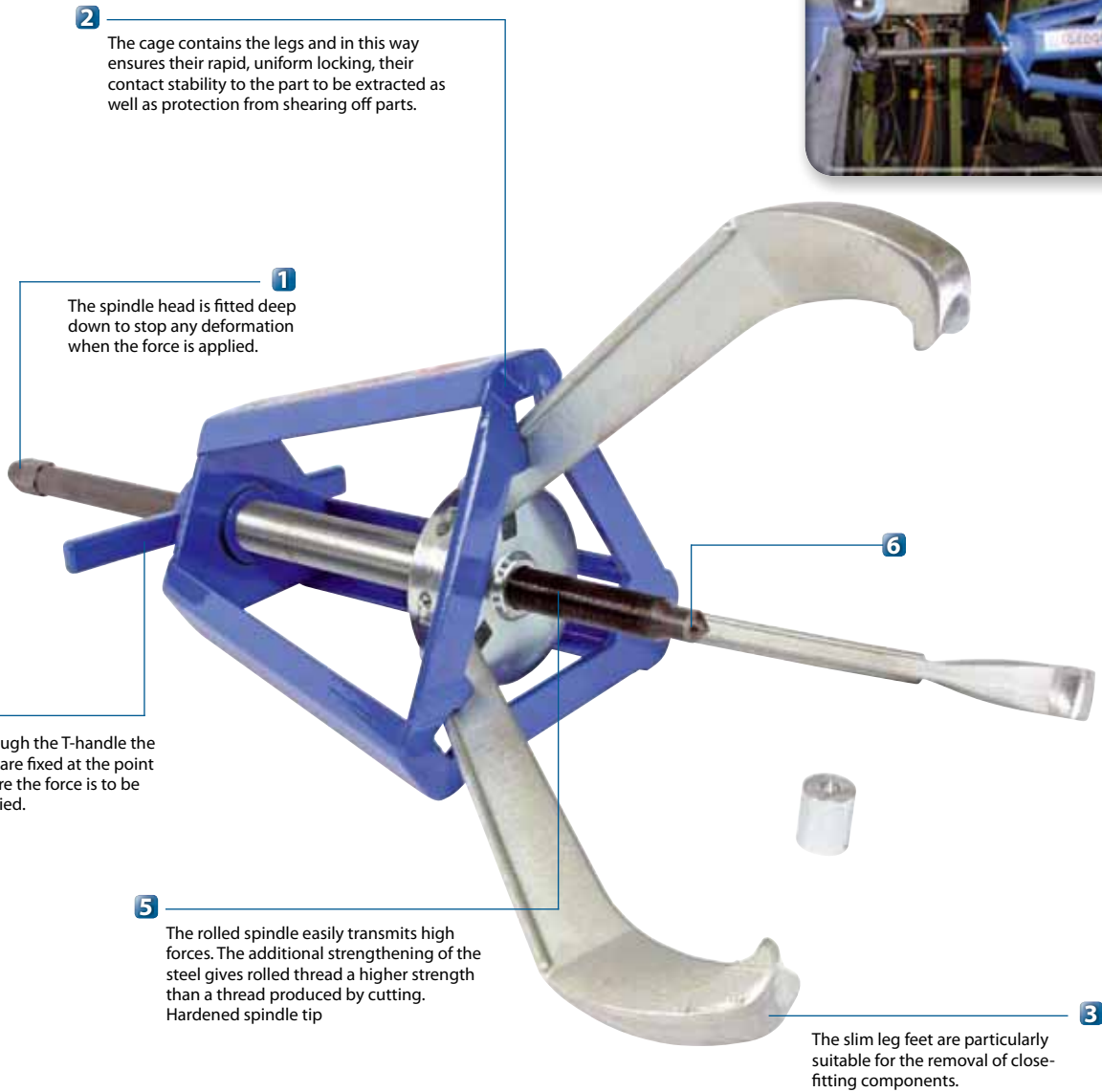

i **The cage is the key for safe pulling...**

... as through the cage, the legs are fixed at the point where the force is to be applied - thus the legs cannot slip off, even on a small contact surface.

Depending on the model, different accessories complete the extractor usefully: Spindle protection, spindle extension, transport cart and extended legs for larger clamping widths and depths can simplify the work and upgrade the puller for more pulling situations.

i **All spare parts and accessories for manual pullers are listed on page 416**



8.06

MANUAL HEAVY-DUTY PULLER 2-arm pattern

- ✔ Suitable for the removal of ball bearings, pulleys, wheels, and other close-fitting components
- ✔ Cage and T-handle enable easy and fast operation - opening, closing, locking and aligning of the legs by simply turning the T-handle
- ✔ The product range offers a wide variety of clamping widths and depths, and load limits
- ✔ Legs drop forged
- ✔ Through the cage, the legs are fixed at the point where the force is to be applied - thus the legs cannot slip off, even on a small contact surface
- ✔ Upgradeable with spindle extension and extended legs

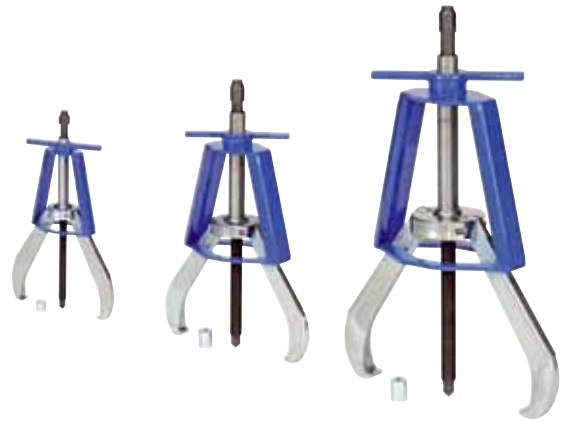

Code	No.	Ø spindle A	max. clamping reach B	max. clamping width B	max. t	max. torque N·m	Total height D	Width of hooked foot E	Actuating Hexagon F	optional long legs	
2207176	8.06/6	19,0	246	25-381	12	237	518.4	25.4	24.0	806/601L	5.9
2207311	8.06/7	28,5	305	64-457	22	642	692.2	32.0	30.0	806/701L	16.8
2207435	8.06/8	30,0	356	76-635	31	1085	813.8	38.0	30.0	---	25.3

8.07

MANUAL HEAVY-DUTY PULLER 3-arm pattern

- ✔ Suitable for the removal of ball bearings, pulleys, wheels, and other close-fitting components
- ✔ Cage and T-handle enable easy and fast operation - opening, closing, locking and aligning of the legs by simply turning the T-handle
- ✔ The product range offers a wide variety of clamping widths and depths, and load limits
- ✔ Legs drop forged
- ✔ Through the cage, the legs are fixed at the point where the force is to be applied - thus the legs cannot slip off, even on a small contact surface
- ✔ Upgradeable with spindle extension and extended legs

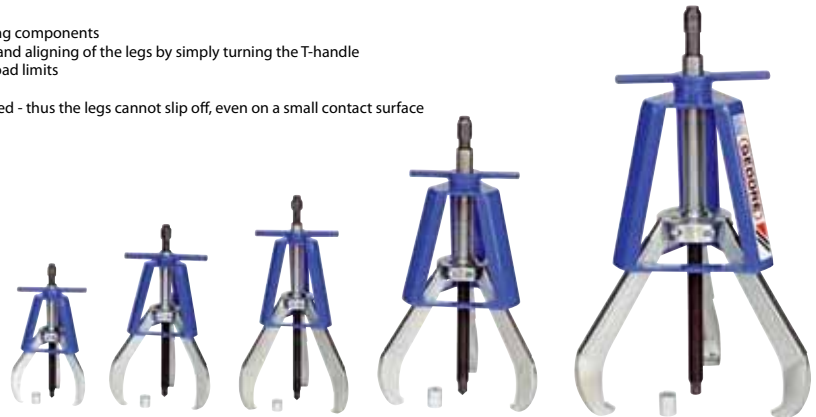

Code	No.	Ø spindle A	max. clamping reach B	max. clamping width B	max. t	max. torque N·m	Total height D	Width of hooked foot E	Actuating Hexagon F	optional long legs	optional extra long legs	
2206870	8.07/4	15,8	152	13-178	9	176	338.3	19.0	19.0	---	---	3.2
2206994	8.07/5	19,0	203	19-305	15	299	412.8	22.2	24.0	806/601	806/601L	5.9
2207079	8.07/6	19,0	246	25-381	18	373	518.4	25.4	24.0	806/601L	---	6.8
2207206	8.07/7	28,5	305	64-457	27	811	692.2	32.0	30.0	806/701L	---	19.5
2207354	8.07/8	30,0	356	76-635	36	1152	813.8	38.0	30.0	---	---	29.5

8.31/1

MANUAL HEAVY-DUTY INTERNAL PULLER SET 3-arm pattern

- ✔ Suitable for removing tightly-fitting ball bearings, seals, bushings, etc.
- ✔ Wide clamping range: two leg sets 3 pieces each
- ✔ Two slide hammers: 1.13 kg and 2.27 kg
- ✔ Cage and T-handle enable easy and fast operation - opening, closing, locking and aligning of the legs by simply turning the T-handle
- ✔ Legs drop forged
- ✔ Through the cage, the legs are fixed at the point where the force is to be applied - thus the legs cannot slip off, even on a small contact surface

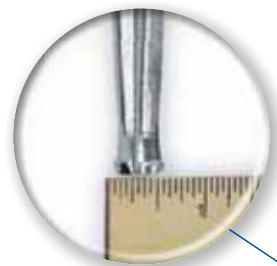
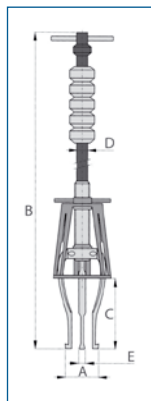

Code	No.	Clamping width max. short legs A	Clamping width max. long legs A	Clamping depth max. short legs C	Clamping depth max. long legs C	Height short legs B	Height long legs B	Ø Spindle D	Width of hooked foot E
2207478	8.31/1	100	133	120	170	736.6	787.4	13,2	8.4

++ HYDRAULIC HEAVY-DUTY PULLERS

- ✔ The 2- and 3-arm pullers are suitable for the removal of ball bearings, pulleys, wheels, and other close-fitting components
- ✔ Cage and T-handle enable easy and fast operation - opening, closing, locking and aligning of the legs by simply turning the T-handle
- ✔ The product range offers a wide variety of clamping widths and depths, and load limits
- ✔ Various delivery options: Loose puller or complete set including hydraulic cylinder, pump and pressure hose



4 The handle is fastened at the hydraulic cylinder and is for transporting, attaching and hanging up the puller.

1 Through the T-handle, the legs are fixed at the point where the force is to be applied.

2 The cage contains the legs and in this way ensures their rapid, uniform locking, their contact stability to the part to be extracted as well as protection from shearing off parts.

3 The slim leg feet are particularly suitable for the removal of close-fitting components.

5 The pressure pads allow the cylinder to be equipped with various tips for centred and non-centred shafts.



All spare parts and accessories for hydraulic pullers are listed on page 416



Technical information about cylinder and pumps are listed on page 414 - 415



8.07/HYD

HYDRAULIC HEAVY-DUTY PULLER 3-arm pattern

- ✔ Suitable for the removal of ball bearings, pulleys, wheels, and other close-fitting components
- ✔ Cage and T-handle enable easy and fast operation - opening, closing, locking and aligning of the legs by simply turning the T-handle
- ✔ The product range offers a wide variety of clamping widths and depths, and load limits
- ✔ Legs drop forged
- ✔ Through the cage, the legs are fixed at the point where the force is to be applied - thus the legs cannot slip off, even on a small contact surface
- ✔ Scope of delivery: Puller, lid with screws and various pressure pads for centred and non-centred shafts
- ✔ Upgradeable with extended legs

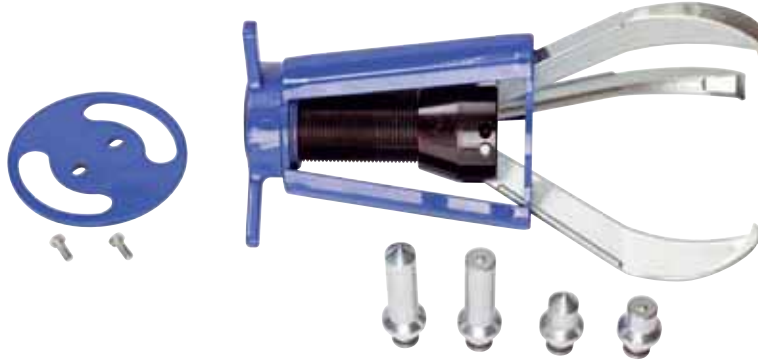

Code	No.	max. t	max. clamping reach	max. clamping width	optional long legs	optional extra long legs
2207605	8.07/5 HYD	9	203	19-305	806/601	806/601L
2207702	8.07/6 HYD	13	254	25-315	806/H601L	---
2207796	8.07/7 HYD	22	305	64-457	806/701L	---
2207915	8.07/8 HYD	45	356	76-620	---	---



8.07/HYD-Z

HYDRAULIC HEAVY-DUTY PULLER 3-arm pattern, with hydraulic cylinder

- ✔ Suitable for the removal of ball bearings, pulleys, wheels, and other close-fitting components
- ✔ Cage and T-handle enable easy and fast operation - opening, closing, locking and aligning of the legs by simply turning the T-handle
- ✔ The product range offers a wide variety of clamping widths and depths, and load limits
- ✔ Legs drop forged
- ✔ Through the cage, the legs are fixed at the point where the force is to be applied - thus the legs cannot slip off, even on a small contact surface
- ✔ Scope of delivery: Puller, hydraulic cylinder, lid with screws and various pressure pads for centred and non-centred shafts
- ✔ Upgradeable with extended legs

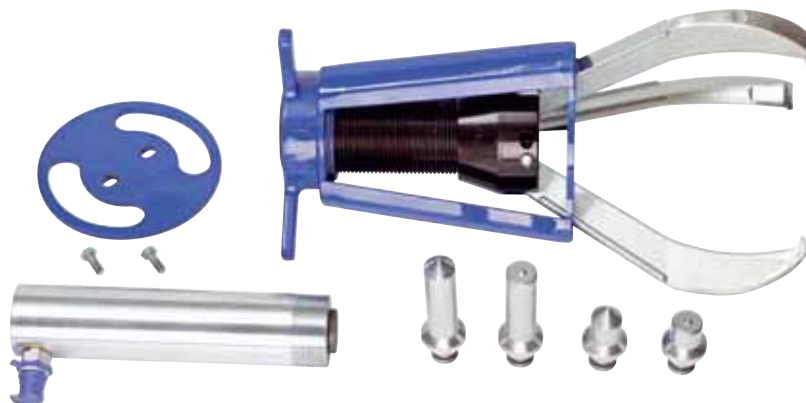

Code	No.	included in delivery	max. t	max. bar in set	max. clamping reach	max. clamping width	optional long legs	optional extra long legs
2209608	8.07/5 HYD-Z	Hydraulic cylinder 8.51/5	9	560	203	19-305	806/601	806/601L
2209616	8.07/6 HYD-Z	Hydraulic cylinder 8.51/6	13	560	254	25-315	806/H601L	---
2209624	8.07/7 HYD-Z	Hydraulic cylinder 8.51/7	22	670	305	64-457	806/701L	---
2209632	8.07/8 HYD-Z	Hydraulic cylinder 8.51/8	45	620	356	76-620	---	---

8.07/HYD-M

HYDRAULIC HEAVY-DUTY PULLER 3-arm pattern, with hydraulic cylinder and manual pump

- ✔ Suitable for the removal of ball bearings, pulleys, wheels, and other close-fitting components
- ✔ Cage and T-handle enable easy and fast operation - opening, closing, locking and aligning of the legs by simply turning the T-handle
- ✔ The product range offers a wide variety of clamping widths and depths, and load limits
- ✔ Legs drop forged
- ✔ Through the cage, the legs are fixed at the point where the force is to be applied - thus the legs cannot slip off, even on a small contact surface
- ✔ Scope of delivery: Puller, hydraulic cylinder, lid with screws and various pressure pads for centred and non-centred shafts, high-pressure hose and manual pump
- ✔ Upgradeable with extended legs



Code	No.	included in delivery	max. t	max. bar in set	max. clamping reach	max. clamping width	optional long legs	optional extra long legs
2209640	8.07/5 HYD-M1	Hydraulic cylinder 8.51/5 and manual pump 8.52/1	9	560	203	19-305	806/601	806/601L
2209659	8.07/5 HYD-M2	Hydraulic cylinder 8.51/5 and manual pump 8.52/2	9	560	203	19-305	806/601	806/601L
2209705	8.07/6 HYD-M1	Hydraulic cylinder 8.51/6 and manual pump 8.52/1	13	560	254	25-315	806/H601L	---
2209713	8.07/6 HYD-M2	Hydraulic cylinder 8.51/6 and manual pump 8.52/2	13	560	254	25-315	806/H601L	---
2209772	8.07/7 HYD-M2	Hydraulic cylinder 8.51/7 and manual pump 8.52/2	22	670	305	64-457	806/701L	---
2209829	8.07/8 HYD-M2	Hydraulic cylinder 8.51/8 and manual pump 8.52/2	45	620	356	76-620	---	---

8.07/HYD-P

HYDRAULIC HEAVY-DUTY PULLER 3-arm pattern, with hydraulic cylinder and air hydraulic pump

- ✔ Suitable for the removal of ball bearings, pulleys, wheels, and other close-fitting components
- ✔ Cage and T-handle enable easy and fast operation - opening, closing, locking and aligning of the legs by simply turning the T-handle
- ✔ The product range offers a wide variety of clamping widths and depths, and load limits
- ✔ Legs drop forged
- ✔ Through the cage, the legs are fixed at the point where the force is to be applied - thus the legs cannot slip off, even on a small contact surface
- ✔ Scope of delivery: Puller, hydraulic cylinder, lid with screws and various pressure pads for centred and non-centred shafts, high-pressure hose and air hydraulic pump
- ✔ Upgradeable with extended legs



Code	No.	included in delivery	max. t	max. bar in set	max. clamping reach	max. clamping width	optional long legs	optional extra long legs
2209667	8.07/5 HYD-P1	Hydraulic cylinder 8.51/5 and air hydraulic pump 8.53/1	9	560	203	19-305	806/601	806/601L
2209675	8.07/5 HYD-P2	Hydraulic cylinder 8.51/5 and air hydraulic pump 8.53/2	9	560	203	19-304	806/601	806/601L
2209721	8.07/6 HYD-P1	Hydraulic cylinder 8.51/6 and air hydraulic pump 8.53/1	13	560	254	25-315	806/H601L	---
2209748	8.07/6 HYD-P2	Hydraulic cylinder 8.51/6 and air hydraulic pump 8.53/2	13	560	254	25-315	806/H601L	---
2209780	8.07/7 HYD-P1	Hydraulic cylinder 8.51/7 and air hydraulic pump 8.53/1	22	670	305	64-457	806/701L	---
2209799	8.07/7 HYD-P2	Hydraulic cylinder 8.51/7 and air hydraulic pump 8.53/2	22	670	305	64-457	806/701L	---
2209837	8.07/8 HYD-P2	Hydraulic cylinder 8.51/8 and air hydraulic pump 8.53/2	45	620	356	76-620	---	---

**8.07/HYD-E****HYDRAULIC HEAVY-DUTY PULLER 3-arm pattern, with hydraulic cylinder and motor pump**

- ✔ Suitable for the removal of ball bearings, pulleys, wheels, and other close-fitting components
- ✔ Cage and T-handle enable easy and fast operation - opening, closing, locking and aligning of the legs by simply turning the T-handle
- ✔ The product range offers a wide variety of clamping widths and depths, and load limits
- ✔ Legs drop forged
- ✔ Through the cage, the legs are fixed at the point where the force is to be applied - thus the legs cannot slip off, even on a small contact surface
- ✔ Scope of delivery: Puller, hydraulic cylinder, lid with screws and various pressure pads for centred and non-centred shafts, high-pressure hose and motor pump
- ✔ Upgradeable with extended legs



Code	No.	included in delivery	max. t	max. bar in set	max. clamping reach	max. clamping width	optional long legs	optional extra long legs
2209683	8.07/5 HYD-E1	Hydraulic cylinder 8.51/5 and motor pump 8.54/1	9	560	203	19-305	806/601	806/601L
2209691	8.07/5 HYD-E2	Hydraulic cylinder 8.51/5 and motor pump 8.54/2	9	560	203	19-305	806/601	806/601L
2209756	8.07/6 HYD-E1	Hydraulic cylinder 8.51/6 and motor pump 8.54/1	13	560	254	25-315	806/H601L	---
2209764	8.07/6 HYD-E2	Hydraulic cylinder 8.51/6 and motor pump 8.54/2	13	560	254	25-315	806/H601L	---
2209802	8.07/7 HYD-E1	Hydraulic cylinder 8.51/7 and motor pump 8.54/1	22	670	305	64-457	806/701L	---
2209810	8.07/7 HYD-E2	Hydraulic cylinder 8.51/7 and motor pump 8.54/2	22	670	305	64-457	806/701L	---
2209845	8.07/8 HYD-E2	Hydraulic cylinder 8.51/8 and motor pump 8.54/2	45	620	356	76-620	---	---

**8.01****TRANSPORT CART**

- ✔ For fast and handy transport as well as convenient storage of a hydraulic puller and its accessories
- ✔ Delivery without puller and accessories



Code	No.	Weight
2208059	8.01	29.0



All spare parts and accessories for hydraulic pullers are listed on page 416



Technical information about cylinder and pumps are listed on page 414 - 415



HYDRAULIK COMPONENTS

8.51

HYDRAULIC CYLINDER for heavy-duty pullers

- Single-acting universal cylinder in compact design
- With spring return, large stroke length and high-quality guide belts
- The construction of the polyurethane wiper prevents that dirt can get between the piston and cylinder wall
- Piston rod of the hydraulic cylinder is especially protected against corrosion
- Delivery includes non-drip fitting and dust covers



Code	No.	Working pressure bar	Power kN	Power t	Stroke	Oil volume cm ³	$\frac{P}{R}$
2211467	8.51/5	700	111	11	155	247	4.0
2211475	8.51/6	700	166	17	254	603	8.5
2211483	8.51/7	700	232	24	362	1201	17.0
2211491	8.51/8	700	496	51	337	2389	35.0

8.54/1

MOTOR PUMP COMPACT for heavy-duty pullers

- Two-stage, portable motor pump in very compact design
- Useable in all positions
- Electric motor, 230 V, 50 Hz, 0.35 kW
- 3/3 way electromagnetic valve with pressure holding function for hydraulic cylinder
- Remote control with cable, 2.3 m long, control voltage 12 V
- Automatic switching: low / high pressure
- Carrying strap
- Delivery includes non-drip coupler and dust cover



Code	No.	Working pressure bar	Flow rate high pressure l/min	Flow rate low pressure l/min	Valve type	Oil volume cm ³	$\frac{P}{R}$
2211556	8.54/1	700	0.2	2.0	3/3 way	1600	9.5

8.52

MANUAL PUMP for heavy-duty pullers

- With gauge for precise and controlled working
- Convenient and fast working in two-stage operation
- Needle valve for controlled discharge
- Robust aluminium tank
- Built-in safety valve
- Easy oil filling
- Return ports on all models
- Supporting feet with mounting holes
- Delivery includes non-drip coupler and dust cover



Code	No.	Working pressure bar	effective oil volume cm ³	Pump stroke high pressure cm ³	Pump stroke low pressure cm ³	Pump power at max. working pressure N	Gauge type $\frac{P}{R}$	P Pressure connection	R Flyback connection
2211505	8.52/1	700	1000	2	20	320	850/033 8.1	G 1/4"	G 1/4"
2211513	8.52/2	700	2400	2	20	320	850/033 9.9	G 1/4"	G 1/4"

8.54/2

MOTOR PUMP for heavy-duty pullers

- Two-stage, lightweight motor pump with plastic housing
- 3/2 way electromagnetic valve for single-acting hydraulic cylinder
- Remote control with cable, 2 m long, control voltage 24 V
- Automatic switching: low / high pressure
- Delivery includes non-drip coupler and dust cover



Code	No.	Working pressure bar	Working pressure MPa	Flow rate high pressure l/min	Flow rate low pressure l/min	Valve type	Oil volume cm ³	$\frac{P}{R}$
2211564	8.54/2	700	70	0.33	3.3	3/2 way	3790	15.0

8.53

AIR HYDRAULIC PUMP for heavy-duty pullers

- One-stage pump
- Working pressure up to 700 bar
- Delivery includes gauge, non-drip coupler and dust cover
- No. 8.53/1: Compact design, due to a rubber bellow in the tank useable in all positions, with oil gauge glass and silencer
- No. 8.53/2: With remote control for moving out, holding and discharging, cable length: 2.5 m



Code	No.	Working pressure bar	effective oil volume cm ³	Power cm ³ /min	necessary air pressure $\frac{P}{R}$	P Pressure connection	R Flyback connection	Air connection
2211521	8.53/1	700	2100	1.000-200	7,0-12,0	9.6	G 1/4"	G 1/4" NPT 1/4"
2211548	8.53/2	700	9000	1.000-200	6,5-12,0	18.4	G 1/4"	— G 1/4"

850/X33

GAUGE AND GAUGE HOLDER

- Fluid-damped
- Two scales (bar / psi)
- Measuring range from 0 to 1000 bar (15000 psi)
- No. 850/033: Gauge for manual pumps no. 8.52
- No. 850/133: Gauge for air hydraulic and motor pumps (no. 8.53 and no. 8.54)
- Please order separately gauge holder (no. 850/125) for gauge no. 850/133

Code	No.	Measuring range	$\frac{P}{R}$
2273403	850/033	0-1000 bar / 0-15000 psi	50 bar / 1000 psi
2211610	850/133	0-1000 bar / 0-15000 psi	50 bar / 1000 psi
2211602	850/125		

8.55/3

HIGH-PRESSURE HOSE

- Oil resistant, synthetic material with steel reinforcements
- Capacity up to 800 bar working pressure
- Length 3 m, further lengths available on request
- Delivery includes non-drip coupler, fitting and dust covers



Code	No.	Working pressure bar
2211572	8.55/3	800

**850/18X****COUPLER AND FITTING**

- ▶ With automatic locking mechanism
- ▶ Delivery includes dust cover



Code	No.	Working pressure MPa	Working pressure bar	Internal thread	External thread	A	B	Ø mm
2211580	850/188	100	1000	G 1/4"	---	59	27.0	24
2211599	850/189	100	1000	---	G 1/4"	37	24.5	22

8.06/580-155**PRESSURE PAD SET for puller 8.07/5 HYD + 8.07/6 HYD**

Code	No.	Contents	↳
2207680	8.06/580-155	consisting of:	1.4

Code	No.	Description
2209853	806/580-151	Cylinder tip 25 x 25 mm flat
2209861	806/580-152	Cylinder tip 25 x 76 mm flat
2209888	806/580-153	Cylinder tip 25 x 38 mm conical
2209896	806/580-154	Cylinder tip 25 x 89 mm conical

**8.06/780-257****PRESSURE PAD SET for puller 8.07/7 HYD**

Code	No.	Contents	↳
2207885	8.06/780-257	consisting of:	6.8

Code	No.	Description
2209918	806/780-251	Cylinder tip 38 x 57 mm flat
2209926	806/780-252	Cylinder tip 51 x 64 mm flat
2209934	806/780-253	Cylinder tip 51 x 102 mm flat
2209942	806/780-254	Cylinder tip 38 x 64 mm conical
2209950	806/780-255	Cylinder tip 51 x 64 mm conical
2209969	806/780-256	Cylinder tip 51 x 114 mm conical

8.06/880-508**PRESSURE PAD SET for puller 8.07/8 HYD**

Code	No.	Contents	↳
2208040	8.06/880-508	consisting of:	13.6

Code	No.	Description
2209977	806/880-501	Cylinder tip 51 x 76 mm flat
2209985	806/880-502	Cylinder tip 70 x 76 mm flat
2209993	806/880-503	Cylinder tip 70 x 127 mm flat
2210002	806/880-504	Cylinder tip 51 x 95 mm conical
2210010	806/880-505	Cylinder tip 70 x 95 mm conical
2210029	806/880-506	Cylinder tip 70 x 140 mm conical
2210037	806/880-507	Adaptor 70 x 57 mm



All spare parts and accessories for hydraulic pullers are listed on page 416



Accessories and spare parts for manual heavy-duty pullers

Spare parts 2-arm	8.06/6	8.06/7	8.06/8
(1) Cage	806/631	806/731	806/831
(2) Legs	806/601	806/701	806/801
(3) Head	806/604	806/704	806/804
(4) Pin	806/518	806/718	806/718
(5) T-handle	806/509	806/709	806/809
(6) Spindle	806/606	806/706	806/806
(7) Circlip	806/591	806/791	806/891
(8) Spindle protection	806/510	806/710	806/710
Accessories 2-arm		max. spanwidth / -depth	max. spanwidth / -depth
Leg long	806/601L	38-559 / 406	806/701L 38-762 / 508
Spindle extension	806/516		

Spare parts 3-arm	8.07/4	8.07/5	8.07/6	8.07/7	8.07/8
(1) Cage	807/431	807/531	807/631	807/731	807/831
(2) Legs	806/401	806/501	806/601	806/701	806/801
(3) Head	807/404	807/504	807/604	807/704	807/804
(4) Pin	806/418	806/518	806/518	806/718	806/718
(5) T-handle	806/409	806/509	806/509	806/709	806/809
(6) Spindle	806/406	806/506	806/606	806/706	806/806
(7) Circlip	806/491	806/591	806/591	806/791	806/891
(8) Spindle protection	806/410	806/510	806/510	806/710	806/710
Accessories 3-arm		max. spanwidth / -depth	max. spanwidth / -depth	max. spanwidth / -depth	max. spanwidth / -depth
Leg long		806/601 57-381 / 154	806/601L 38-559 / 406	806/701L 38-762 / 508	
Leg extra long		806/601L 38-559 / 406			
Spindle extension	806/416	806/516	806/516		

Accessories and spare parts for hydraulic heavy-duty pullers

Spare parts	8.07/5 HYD	8.07/6 HYD	8.07/7 HYD	8.07/8 HYD
(1) Cage	807/H531	807/H631	807/H731	807/H831
(2) Legs	806/501	806/H601	806/701	806/H801
(3) Head	807/H504	807/H604	807/H704	807/H804
(4) Pin	806/H518	806/H618	806/718	806/H818
(5) T-handle	806/H509	806/H609	806/H709	806/H809
(6) Spindle	806/H591	806/H691	806/H791	806/H891
(7) Circlip	806/H511	806/H511	806/H711	807/H811
Lid	8.06/580-155	8.06/580-155	8.06/780-257	8.06/880-508
Accessories		max. spanwidth / -depth	max. spanwidth / -depth	max. spanwidth / -depth
Leg long	806/601	58-401 / 249	806/H601L 38-559 / 406	806/701L 38-762 / 508
Leg extra long	806/601L	38-559 / 406		
			8.01	8.01



SAFETY NOTES

- ▣ The design of GEDORE heavy-duty pullers provides for a maximum degree of safety.
- ▣ Even so, do bear in mind that extremely high forces are involved when pulling and so go about the operation carefully!
- ▣ Do observe the following safety instructions when pulling is involved and make them known to those carrying out the work.

...5.10 as a protection from shearing off components...

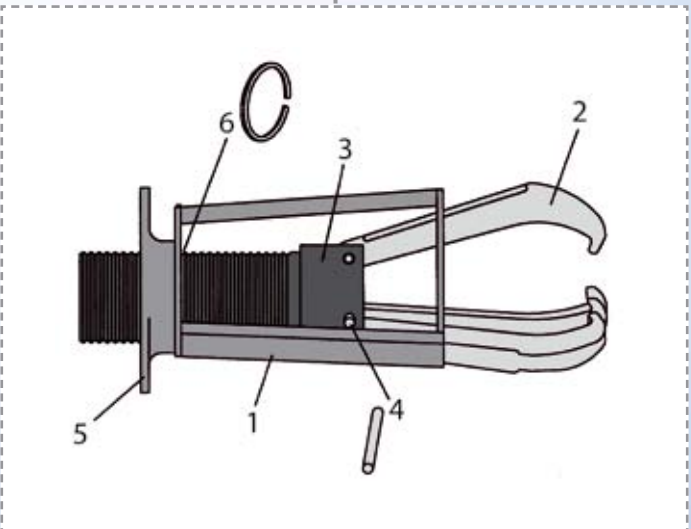
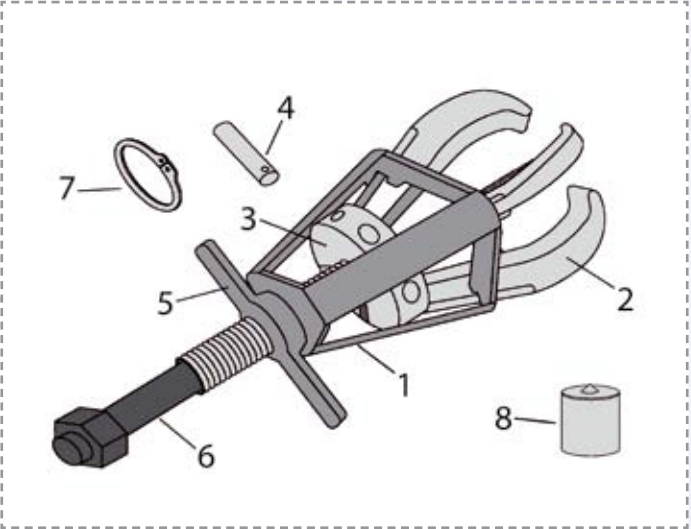
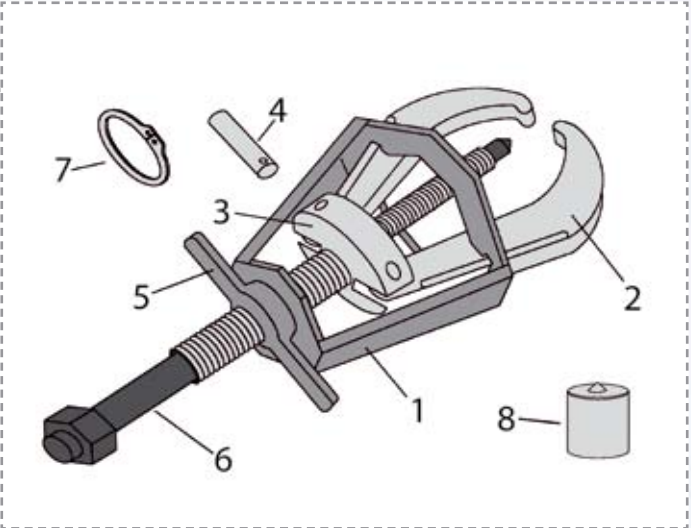



BIR
1069
300



GEDORE
ROT BAND-PLUS
GERMAN

2

3

4

6



++ FOR SAFE STRIKING +



SERVICE / FEATURES		420 - 427
ENGINEERS' HAMMERS		428 - 431
CLUB HAMMERS		432 - 433
SLEDGE HAMMERS		434 - 435
BRICKLAYER'S HAMMERS		435 - 436
CARPENTER'S HAMMERS		436
CLAW HAMMERS		437
RECOILLESS HAMMERS		440 - 441
SAFETY HAMMERS		442 - 443
FORGING TOOLS		445 - 447
SCRAPERS		447 - 448
CHISELS		449 - 454
DRIFT / CENTRE / PIN PUNCHES		454 - 455
SETS		456 - 457
BENDING BARS / PRYBARS		459
NAIL LIFTER / CROWBARS		460



GEDORE HAMMERS AND STRIKING TOOLS ----- ++

FOR TOUGH WORK AND PRECISION ALIKE

- ✔ Large selection of hammers: from the tile hammer, recoilless hammer, forging tool and engineer's hammer through to the sledge hammer
- ✔ Top-grade industrial quality for the hardest of continuous uses
- ✔ Available singly or in practical sets
- ✔ Customized manufacturing and types on request



+ TOP QUALITY - EVERYTHING FROM A SINGLE SOURCE

- ✔ The base is made up of stringently controlled quality steel and meticulously selected wood
- ✔ Experienced and reliable specialists vouch for precision-like processing
- ✔ Hammer head and shaft (up to 400 mm) are made in GEDORE's own production facilities in Germany
- ✔ Stringent quality checks after each production step ensure a constantly high level



ROT BAND-PLUS SYSTEM - DEPENDABILITY UNDER EXTREME LOADING ++

- ✔ Hammers utilize the ROT BAND-PLUS securing system - "no losing of heads" as a result
- ✔ The ideal aid for site work
- ✔ Models with extra inductively tempered edges of the faces



++ GEDORE STRIKING TOOLS

- ✔ Large selection including chisels, center punches and drift punches
- ✔ With optional hand guard
- ✔ Also available in the range/set
- ✔ Precisely hardened and annealed - long tool life



+ FOR HAMMERS

HAMMER HEAD



1 C45 hardened and tempered steel precisely cropped to length.



2 Hot pre-forged in a double forging die.



3 Fully forged blank.



4 De-burring of the blanks.



5 Production of the hammer eye.



6 After descaling the blank, it is machined all round in accordance with DIN 1193. The pein and face of the hammer head are additionally ground.



7 The hammer head is induction hardened to 50-58 HRC and then annealed. Care has to be taken to ensure that, within a defined measured area, the hardness deviation is no greater than 5 HRC. The hardening depth on the face and pein must be at least 3 mm. The hardness of the eye zones, however, must not exceed 30 HRC. The hammer head now has hard striking faces and a soft "shock absorber" zone. These safety-relevant values are subject to continuous monitoring. The hammer head is permanently stamped with the manufacturer's mark, weight and DIN 1041.



8 The hammer head is sand blasted to descale and degrease it.



9 Corrosion protection by stove enamelling.



10 The hammer face and pein are ground bright in accordance with DIN 1041. Attention is paid here particularly to regular clean edges and to a slight convex geometry of the face.



HAMMER SHAFT



1 Shaft blank from hickory. This tough wood has long fibres, making it ideal for hammer shafts. The long fibres cushion the impact in the hand. The tight annealed rings give the wood its flexural strength.



2 The square shaft blank is cut to size.



3 The hammer shaft is milled.



4 The look is improved by sanding.



5 Coating with water-soluble clear varnish.



6 The hand end is set off in mahogany staining.



7 The shaft protection sleeve is pressed on and the shaft tampon printed.

HAMMERS

TIP: HOW CAN I TELL IF THE HAMMER IS A RELIABLE ONE?

The hammer head must be correctly hardened and tempered

No precision hardening and annealing - also referred to tempering - can be checked on without the use of aids. The hammer face and pein must have a hardness of between 50 and 58 HRC. Hardness must reach down to at least 3 mm. 30 HRC is not to be exceeded at the inserting eye for safety reasons.
 - GEDORE manufactures on the basis of the above DIN 1193 requirements and meets them at the same time. Constant tests vouch for these figures.

DIN designation solely in association with the manufacturer's logo.

- GEDORE stamps in DIN 1041 weight details and logo (The German equipment safety law points to the insufficiency of weight details and stamping of DIN 1041).

Permanent, clear-cut fitting of the manufacturer's logo

- GEDORE stamps or forges the prescribed information into the hammer head in a permanent and legible manner.

Accurate 45° edge at hammer face and pein

The edge - also referred to as chamfer - stops any dangerous splintering. GEDORE hammers have a clean-cut edge as conforming to regulations.

Distinctive manufacturer's name on the hammer head

- GEDORE inscribes its hammer heads with **HB (Hermann Bremer)**.

Assured and firm connection/fitting of hammer shaft and head

Take a look: are there any gaps between hammer eye and shaft? The wooden shaft must be secure and shake-free in the hammer head. The shaft/hammer head connection must be securely wedged.
 - GEDORE only uses tapered collars which ensure optimum distribution of the clamping force in the hammer eye.
 - The ROTBAND-PLUS system developed and patented by GEDORE turns the ordinary DIN hammer into a "safety hammer".

Is the shaft fault-free?

The hammer shaft is not to have any cracks, branch holes or other faults. Nor every type of wood is suitable for hammer shafts. Hickory and ash are noted as the preferred woods in DIN 68340.
 - Only these two wood types are used by GEDORE in its own manufacturing process.



Note:

Rubber handgrip feature: make sure the handgrip is firmly bonded to the shaft. Try out the turning test. A handgrip which can still be turned on the hammer shaft does not meet the DIN-prescribed figures.

Note:

Intensive testing of steel tube, fibre glass and plastic shafts as to a firm fit in the hammer head is required. Preference is for hammers with an additionally secured head. The head is also positively fitted to the hammer shaft by means of a spring pin. **GEDORE Safety: Beat for beat!**



SAFETY NOTES FOR HAMMERS

- Wear safety glasses and safety gloves!
- Use the hammer only for its intended purpose!
- Never misuse the hammer as a lever!
- Before starting work, check that the hammer head is securely attached to the shaft!
- Select the appropriate type and size of hammer for the work to be carried out!
- Never hit two hammers together!
- Never use steel hammers on workpieces harder than 46 HRC! Use suitable plastic-faced hammers for this! In case of doubt, the healthier choice is a suitable plastic-faced hammer.
- Avoid bouncing blows!
- Use only the work faces of the hammer! Blows with the side face damage the non-hardened hammer eye. This can loosen the grip of the shaft in the hammer head.
- If a burr forms on the pein or face of the hammer head, this must be immediately removed. Failure to do this can pose the risk of splintering when the hammer is in use.
- Grip the hammer shaft as far away from the hammer head as possible! This improves the impact effect and avoids vibrations.
- Do not store hammers with wooden shafts in warm, dry environments! Wood is a natural product. Dry, warm storage conditions cause the shaft to lose moisture and shrink, so that the hammer shaft is no longer a tight fit in the hammer head. Opposite storage conditions also have a negative effect on the wooden shaft. Do not store the wooden shaft in too damp conditions! Too much moisture causes the wooden shaft to swell up and destroys the wooden fibres. This can result in the wooden shaft snapping behind the eye area.
- Use only approved hammers for work in explosion-hazard areas!
- Use only suitable GEDORE replacement shafts and wedges.



i WOOD IS A NATURAL PRODUCT!

- GEDORE uses only wood types and timbers that comply with DIN 68 340 (Wooden Shafts for Impact Tools)
- Wood retains its natural properties even after processing
- Trees regulate their moisture content by giving off moisture through their pores. This property is retained in processed wood. This means that a wooden hammer shaft loses moisture through its pores when the air humidity is low.
- DIN 68 340 defines the required moisture content of the hammer shaft at the time of joining the shaft to the head. This must be between 12% and 14% in relation to the dry weight. In-house manufacture under continuous quality controls guarantees compliance with the requirements of DIN 68 340.

Tip:

- Before use, always check that the hammer head is securely attached to the shaft!
- Never store the hammer in too dry conditions!
- Storage in well-heated rooms or near a source of heat is particularly harmful, drawing moisture out of the hammer shaft, causing the shaft section to shrink. In extreme cases, the secure fit of the hammer head on the shaft can no longer be guaranteed.

ADVANTAGES OF THE DIFFERENT HANDLE TYPES

HICKORY HANDLES

- High quality and extremely break-proof wood. Compared with ash the physical load stability of hickory is around 3-4 times higher
- Long-fibre structure: More safety in the event of a handle breakage - the wood is held together by the long fibres and hence uncontrolled separation of the broken handle as well as the hammer head is avoided
- Vibration dampening
- Long life = very good price/performance ratio



ASH HANDLES

- This wood is prescribed by the DIN as the minimum wood quality
- Inexpensive
- Break-proof
- Short-fibre structure: the short fibres in the wood mean that, in the event of a break, the shaft cannot be held together. The shaft breaks into two parts.



FIBRE GLASS HANDLES

- Robust - virtually unbreakable
- Insensitive to all weather conditions - can also be fully used in minus temperatures and is still unbreakable
- Resistant to all common chemicals such as for example oils and greases



























TUBULAR STEEL HANDLES

- High bending strength
- Resistant to the influence of weather





		 ROTBAND-PLUS	 hickory	 ash	 tubular steel	 fibreglass	 plastic	 inductive	 g	
	600 E	●		●					100 - 2000	
	600H	●	●						100 - 2000	
	600 IH	●	●					●	200 - 2000	
	4 E			●					50 - 2000	
	4 H		●						50 - 2000	
	4 IH		●					●	200 - 2000	
	4 K						●		200 - 1000	
	500 F					●			200 - 2000	
	500 ST				●				300 - 500	
	525 H	Rotband	●						500	
	8601			●					1/4 LBS - 2 LBS	
	601 H	●	●						300 - 500	
	65 E			●					100 - 600	
	620 E	●		●					1000 - 2000	
	620 H	●	●						1000 - 2000	
	20 E			●					1000 - 10000	
	20 H		●						1000 - 10000	
	20 F					●			1000 - 10000	
	20 ST				●				1000 - 1250	
	646 H	●	●						1000 - 2000	
	46 E			●					1000 - 2000	
	609 H	●	●						3000 - 10000	
	9 E			●					3000 - 10000	
	9 H		●						3000 - 10000	
	9 F					●			3000 - 10000	
	10 E			●					3000 - 6000	
	10 H		●						3000 - 6000	
	17 E			●					3000 - 10000	
	29 E			●					500 - 600	
	29 ST				●				500	
	30 E			●					500 - 700	
	94 E			●					600	
	94 ST				●				600	
	93 ST				●				600	
	75 GSTM				all-steel			600	●	
	575 F					●			600	
	575 FM					●			600	●
	75 STK				●				600	
	75 ST				●				600	
	75 STKM				●				600	●
	75 STM				●				600	●
	71 GSTM				all-steel				●	
	677 H	●	●						300	
	77 ST				●				300 - 400	
	77 E								330	



i ROTBAND-PLUS HAMMER



427

- ▣ The hammer shaft is pressed into the hammer head.
- ▣ The ring wedge is pressed in to secure the shaft in the eye of the hammer head.
- ▣ The round, conical form ensures an all-round, uniform pressure.
- ▣ Tightening the wood screw ensures a positive fit of the safety plate with the shaft.



With the standardised ROTBAND-PLUS handles every standardised hammer head can be turned into a ROTBAND-PLUS hammer.

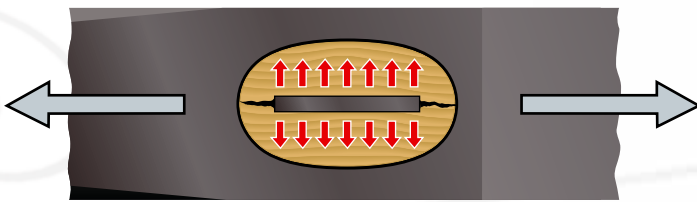

WEDGES

- ▣ No clamping force in the direction of motion thanks to the flat wedge.
- ▣ The tapered collar evenly distributes the clamping force across 360° i.e. also in the direction of motion. The wood fibre structure is not ruined. There is no slackening of the hammer head even after several hundred strikes.
- ▣ The barbed hook ensures a positive fit and stops the tapered collar from loosening. A safety "extra".

GEDORE

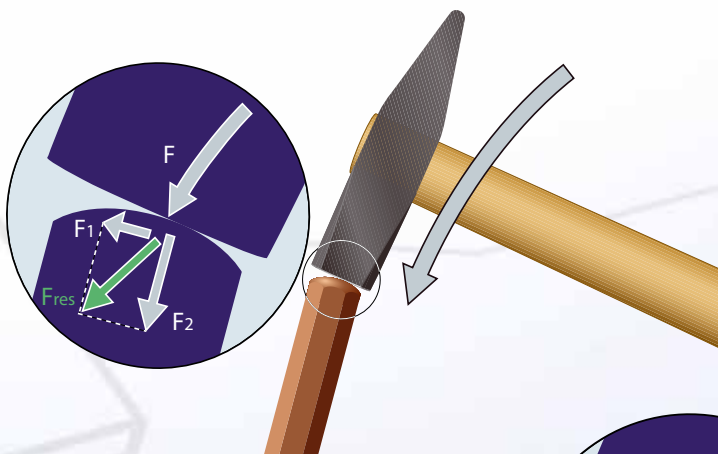
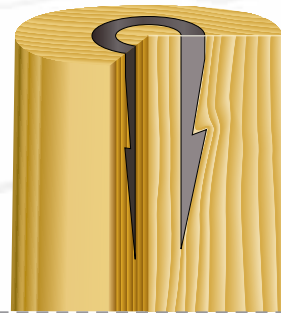
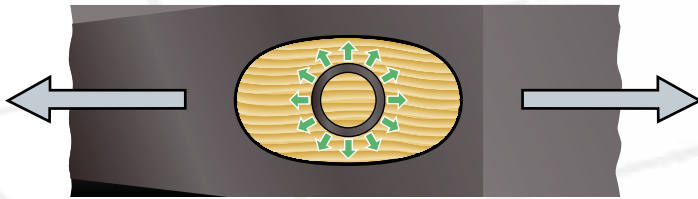

GEDORE HAMMERS AND GEDORE CHISELS – AN ALLIANCE FOR SAFE WORKING

- ▣ Considerable forces are liberated on hammer face and chisel head impacting on each other.
- ▣ GEDORE hammers and chisels are optimally adapted to each other. Their regulation-compliant geometrical shape diverts the bulk of the forces raised towards the chisel tip.
- ▣ In the case of hammers and chisels which are not ground in a regulation-compliant manner, most of the force raised is not transferred to the chisel tip and can, as a result, give rise to serious injuries.

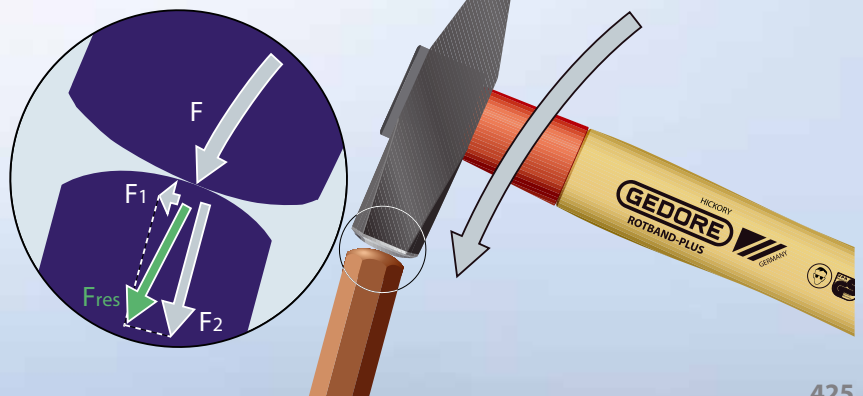



ROT BAND-PLUS HAMMERS

A SAFE JOIN



The hammer head corresponds to the relevant DIN standard. Following the forging process, it is carefully hardened and tempered. This is a guarantee of an extra-long service life.



The join between the hammer head and the handle is one of the most important features of the ROT BAND-PLUS. A wood screw, a tapered collar and a fixing plate ensure a permanent and safe joint.

The protective steel sleeve is hardened and thus resistant to impact. It protects the handle from damage when the hammer misses its target, and gives the hammer head additional security.

The handle is hand-friendly wood, and bend-resistant. This has been proven by tests carried out at the Institute for Testing and Checking (VPA) in Remscheid, Germany.

SAFETY PRINCIPLE



Unprotected hammer handle – After 30 impacts: Noticeable damage to the handle - risk of breakage!



Wooden handle with ROT BAND-PLUS Safety Feature – After 1,000 impacts: Slight traces in the paint, no deformation, absolutely firm seating.



FEATURES

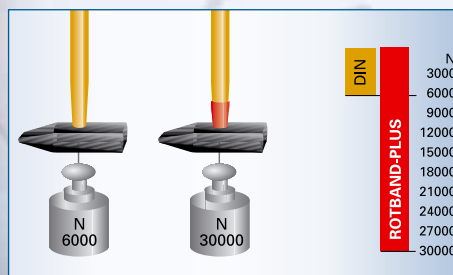

The values required by the German standards institute (DIN) are exceeded considerably. According to the report by the Institute for Testing and Checking (VPA) in Remscheid, with the ROT BAND-PLUS hammers more than five times the required force was attained.



Due to the hardened ROT BAND-PLUS protective sleeve for the handle and the fixing plate, the bending strength of the ROT BAND-PLUS hammers exceeds that of standard DIN hammers by a wide margin.



i ROTBAND-PLUS HAMMER

- ▶ The hammer shaft is pressed into the hammer head.
- ▶ The ring wedge is pressed in to secure the shaft in the eye of the hammer head.
- ▶ The round, conical form ensures an all-round, uniform pressure.
- ▶ Tightening the wood screw ensures a positive fit of the safety plate with the shaft.



- ▶ With the standardised ROTBAND-PLUS handles every standardised hammer head can be turned into a ROTBAND-PLUS hammer.



ALL ADVANTAGES AT A GLANCE ++

- ▶ Patented handle join
- ▶ High safety
- ▶ Long service life
- ▶ Best price-performance ratio
- ▶ The sleeve, the tapered collar, the fixing plate and the wood screw bond the hammer head and the handle into one unit.



ROTBAND-PLUS - OVERVIEW OF RANGE OF HAMMERS





ENGINEERS' HAMMERS ROTBAND-PLUS

600 E + 600 H

ENGINEERS' HAMMER ROTBAND-PLUS

- Forged hammer head DIN 1041
- With contoured ash or hickory handle DIN 5111, additionally shaped with a long hardened handle protective steel sleeve
- The tapered collar, fixing plate and wood screw bond the hammer head and the handle into one unit
- Patented handle join, high working safety, long service life, best price-performance ratio
- DBGM G 9414 1878 (German utility patent), European-Patent-No. 0703045



Code	No.	l mm	mm	mm	mm
8581610	600 E-100	260	100	188	6
8581880	600 E-200	280	200	325	6
8581960	600 E-300	300	300	502	6
8582180	600 E-400	310	400	605	6
8582260	600 E-500	320	500	727	6
8582340	600 E-600	330	600	841	6
8582420	600 E-800	350	800	1135	6
8582500	600 E-1000	360	1000	1326	6
8582690	600 E-1500	380	1500	1908	6
8582770	600 E-2000	400	2000	2491	6
8582850	600 H-100	260	100	188	6
8582930	600 H-200	280	200	325	6
8583070	600 H-300	300	300	502	6
8583150	600 H-400	310	400	605	6
8583230	600 H-500	320	500	727	6
8583310	600 H-600	330	600	840	6
8583580	600 H-800	350	800	1135	6
8583660	600 H-1000	360	1000	1326	6
8583740	600 H-1500	380	1500	1908	6
8583820	600 H-2000	400	2000	2491	6



600 IH

ENGINEERS' HAMMER ROTBAND-PLUS

- Forged hammer head DIN 1041
- The edges of the flat side of the head are induction hardened
- With contoured ash or hickory handle DIN 5111, additionally shaped with a long hardened handle protective steel sleeve
- The tapered collar, fixing plate and wood screw bond the hammer head and the handle into one unit
- Patented handle join, high working safety, long service life, best price-performance ratio



Code	No.	l mm	mm	mm	mm
8583900	600 IH-200	280	200	325	6
8584040	600 IH-300	300	300	502	6
8584120	600 IH-400	310	400	605	6
8584200	600 IH-500	320	500	727	6
8584390	600 IH-600	330	600	841	6
8587300	600 IH-800	350	800	1135	6
8587490	600 IH-1000	360	1000	1326	6
8587570	600 IH-1500	380	1500	1908	6
8588970	600 IH-2000	400	2000	2491	6

640 E + 640 H

DISPLAY RACK FOR HAMMERS 40 pieces

- For engineer's hammers in ROTBAND-PLUS execution
- 640 E with ash handle
- 640 H with hickory handle
- May be hung on a perforated panel
- Dimensions: L 600 x H 400 mm



Code	No.	Contents	mm	mm
8887880	640 E	11x 200g 9x 300g 8x 500g 6x 800g 6x 1000g	32.0	1
8887960	640 H	11x 200g 9x 300g 8x 500g 6x 800g 6x 1000g	32.0	1

E 600 E + E 600 H

SPARE HANDLE ROTBAND-PLUS

- Ash (E 600 E) or hickory (E 600 H) DIN
- With hardened handle protective steel sleeve, tapered collar, fixing plate and wood screw
- With this standard wooden handle, according to DIN 5111 it is possible to convert even ordinary hammer heads, as long as they are to DIN standards, to a ROTBAND-PLUS-hammer
- Method: Hammer the handle into the hammer head until it reaches the casing. Drive the tapered collar into the centre of the handle. Fasten the safety plate with a wood screw

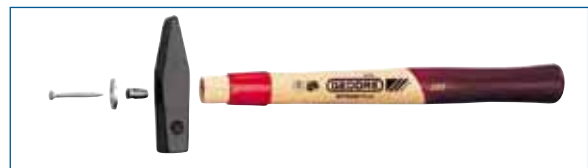

Code	No.	l mm	mm	mm
8589000	E 600 E-100	260	76	10
8589190	E 600 E-200	280	99	10
8589270	E 600 E-300	300	150	10
8589350	E 600 E-400	310	179	10
8589430	E 600 E-500	320	185	10
8589510	E 600 E-600	330	214	10
8589780	E 600 E-800	350	210	10
8589860	E 600 E-1000	360	288	10
8589940	E 600 E-1500	380	350	10
8593700	E 600 E-2000	400	377	10
8593890	E 600 H-100	260	81	10
8595080	E 600 H-200	280	120	10
8595160	E 600 H-300	300	134	10
8595240	E 600 H-400	310	180	10
8596480	E 600 H-500	320	198	10
8596560	E 600 H-600	330	234	10
8596640	E 600 H-800	350	296	10
8597880	E 600 H-1000	360	315	10
8597960	E 600 H-1500	380	373	10
8599070	E 600 H-2000	400	442	10



Helving - made easy

- ▶ Hammer the handle into the hammer head until it reaches the casing
- ▶ Drive the tapered collar into the centre of the handle
- ▶ Fasten the safety plate with a wood screw



E 5

SPARE TAPERED COLLAR

- ▶ For safe fastening of the wooden handles



Code	No.	Ø	(mm)	↕	📦
8593970	E 5-100	7	12.0	1	10
8594000	E 5-200	8	15.0	3	10
8594190	E 5-300	10	17.0	4	10
8594270	E 5-400	11	18.0	5	10
8594350	E 5-500	12	20.0	7	10
8594860	E 5-600	13	20.0	8	10
8594430	E 5-800	14	21.0	9	10
8594940	E 5-1000	14	21.0	10	10
8594510	E 5-1500	15	23.5	13	10
8594780	E 5-2000	16	23.0	14	10

E 630 E + E 630 H

DISPLAY RACK FOR HAMMER HANDLES 36 pieces

- ▶ ROTBAND-PLUS execution
- ▶ E 630 E with ash handles
- ▶ E 630 H with hickory handles
- ▶ For free standing or hanging on a merchandiser
- ▶ Dimensions: 320 x 430 x 210 mm



Code	No.	Contents	↕	📦
8678530	E 630 E	6 handles each 200 g 300 g 400 g 500 g 800 g 1000 g	9.0	1
8679180	E 630 H	6 handles each 200 g 300 g 400 g 500 g 800 g 1000 g	9.0	1



6NA



431

ENGINEERS' HAMMERS

4 E + 4 H

ENGINEERS' HAMMER

- ▶ Forged hammer head DIN 1041
- ▶ With ash (4 E) or hickory handle (4 H) to DIN 5111



Code	No.	(mm)	↕	📦	
8586090	4 E-50	250	50	89	6
8586170	4 E-100	260	100	158	6
8586250	4 E-200	280	200	275	6
8586330	4 E-300	300	300	440	6
8586410	4 E-400	310	400	530	6
8586680	4 E-500	320	500	625	6
8586760	4 E-600	330	600	750	6
8586840	4 E-800	350	800	930	6
8586920	4 E-1000	360	1000	1180	6
8587060	4 E-1500	380	1500	1760	6
8587140	4 E-2000	400	2000	2320	6
8590010	4 H-50	250	50	103	6
8590280	4 H-100	260	100	168	6
8590360	4 H-200	280	200	300	6
8590440	4 H-300	300	300	460	6
8590520	4 H-400	310	400	550	6
8590600	4 H-500	320	500	650	6
8590790	4 H-600	330	600	760	6
8590870	4 H-800	350	800	1030	6
8590950	4 H-1000	360	1000	1210	6
8591090	4 H-1500	380	1500	1859	6
8591170	4 H-2000	400	2000	2370	6



4 IH

ENGINEERS' HAMMER

- ▶ Forged hammer head DIN 1041
- ▶ Carefully hardened and tempered, coated with black epoxy powder
- ▶ With hickory handle DIN 5111



Code	No.	(mm)	↕	📦	
8752600	4 IH-200	280	200	300	6
8752790	4 IH-300	300	300	450	6
8752870	4 IH-400	310	400	550	6
8752950	4 IH-500	320	500	650	6
8753090	4 IH-600	330	600	760	6
8753170	4 IH-800	350	800	1100	6
8753250	4 IH-1000	360	1000	1210	6
8753330	4 IH-1500	380	1500	1860	6
8753410	4 IH-2000	400	2000	2370	6



Handle types

For more information on handle types see page 423.



E 4 E + E 4 H

SPARE HANDLE

- ▲ Ash (E 4 E) or hickory handle (E 4 H), acc. to DIN 5111
- ▲ With oval fixing hole, i.e. for engineers' hammers



Code	No.	l mm	mm	mm
8587650	E 4 E-50	250	33	10
8587730	E 4 E-100	260	45	10
8587810	E 4 E-200	280	85	10
8588030	E 4 E-300	300	99	10
8588110	E 4 E-400	310	100	10
8588380	E 4 E-500	320	160	10
8588460	E 4 E-600	330	140	10
8588540	E 4 E-800	350	165	10
8588620	E 4 E-1000	360	183	10
8588700	E 4 E-1500	380	196	10
8588890	E 4 E-2000	400	261	10
8591250	E 4 H-50	250	33	10
8591330	E 4 H-100	260	58	10
8591410	E 4 H-200	280	85	10
8591680	E 4 H-300	300	85	10
8591760	E 4 H-400	310	120	10
8591840	E 4 H-500	320	140	10
8591920	E 4 H-600	330	150	10
8592060	E 4 H-800	350	210	10
8592140	E 4 H-1000	360	225	10
8592220	E 4 H-1500	380	190	10
8592300	E 4 H-2000	400	280	10

4 K

ENGINEERS' HAMMER

- ▲ Forged hammer head DIN 1041
- ▲ With Ultramid® plastic handle and safety wedge
- ▲ Ultramid® = trade name of BASF AG, Germany



Code	No.	l mm	mm	mm	mm
8812950	4 K-200	280	200	280	6
8604170	4 K-300	300	300	430	6
8604330	4 K-500	320	500	630	6
8604680	4 K-800	350	800	1020	6
8604760	4 K-1000	360	1000	1160	6

E 4 K

SPARE HANDLE

- ▲ Made from Ultramid® plastics
- ▲ Suitable for all hammer heads acc. to DIN 1041
- ▲ Delivery complete with tapered collar and fixing clip
- ▲ Ultramid® = trade name of BASF AG, Germany



Code	No.	l mm	mm	mm
8897170	E 4 K-200	280	70	10
8897250	E 4 K-300	300	90	10
8897330	E 4 K-500	320	120	10
8897410	E 4 K-800	350	180	10
8897680	E 4 K-1000	360	192	10

500 F

ENGINEERS' HAMMER

- ▲ Forged hammer head
- ▲ Nearly unbreakable fiberglass handle with plastic grip
- ▲ Additionally hardened handle protective steel sleeve, with secured head
- ▲ Induction tempered edges of the flat side of the head available on request



Code	No.	l mm	mm	mm	mm
8598180	500 F-200	280	200	360	6
8598260	500 F-300	300	300	570	6
8598340	500 F-400	310	400	660	6
8598420	500 F-500	320	500	770	6
8598500	500 F-600	330	600	900	6
8598690	500 F-800	350	800	1174	6
8598770	500 F-1000	360	1000	1398	6
8598850	500 F-1500	380	1500	1838	6
8598930	500 F-2000	400	2000	2352	6

500 ST

ENGINEERS' HAMMER

- ▲ Forged hammer head
- ▲ Steel tube handle with plastic grip
- ▲ Very robust and durable



Code	No.	l mm	mm	mm	mm
8606620	500 ST-300	270	300	575	6
8606890	500 ST-500	300	500	780	6

www.gedore.com



6 NA

SOFT FACE CAP for engineers' hammers

- Polyethylene



Code	No.	for g	mm	mm	mm
8605570	6 NA-300	300	25	1	
8605650	6 NA-500	500	50	1	
8605730	6 NA-800	800	60	1	
8802990	6 NA-1000	1000	53	1	

525 H

HAMMER KOMBI-PLUS

- Combination of engineers' and plastic hammer
- ROTBAND execution with hardened handle protective steel sleeve
- With hickory handle
- Suitable for nearly all jobs of an engineers' hammer
- The plastic side may be used for all straightening and beating works and hardened work pieces
- Spare head E 225-27



Code	No.	mm	mm	mm	mm	mm
1441310	525 H-500	27	320	500	680	6

JOINERS' HAMMERS

601 H

JOINERS' HAMMER ROTBAND-PLUS French pattern

- Forged hammer head
- The tapered collar, fixing plate and wood screw bond the hammer head and handle into one unit
- With contoured hickory handle DIN 5111
- Additionally hardened steel sleeve
- Patented handle joint, high working safety, long service life, best price-performance ratio



Code	No.	mm	mm	mm	Spare handle	mm
8748840	601 H-22	300	22	410	E 600 H-300	6
8749060	601 H-25	310	25	530	E 600 H-400	6
8749140	601 H-28	320	28	649	E 600 H-500	6

65 E

JOINERS' HAMMER French pattern

- With contoured ash handle DIN 5111



Code	No.	mm	mm	mm	Spare handle	mm
8684260	65 E-18	260	18	220	E 4 E-100	6
8684340	65 E-20	300	20	240	E 4 E-300	6
8684420	65 E-22	300	22	350	E 4 E-300	6
8684500	65 E-25	310	25	450	E 4 E-400	6
8684690	65 E-28	320	28	590	E 4 E-500	6
8684770	65 E-30	330	30	650	E 4 E-600	6



8601

ENGINEER'S BALL PEIN HAMMER

- Hardened and tempered steel to EN 10083
- Enamelled, face and ball ground
- Ash shaft (E-8601 E)



Code	No.	mm	lbs	mm	mm
6764030	8601 1/4 LBS	270	1/4	172	1
6764110	8601 1/2 LBS	290	1/2	307	1
6764380	8601 3/4 LBS	310	3/4	475	1
6764460	8601 1 LBS	325	1	565	1
6764540	8601 1.1/4 LBS	350	1.1/4	772	1
6764620	8601 1.1/2 LBS	365	1.1/2	800	1
6764700	8601 2 LBS	380	2	1073	1
1388371	E-8601 E 1/4 LBS	270		111	1
1797689	E-8601 E 1/2 LBS	290		111	1
1797700	E-8601 E 3/4 LBS	310		111	1
1797719	E-8601 E 1 LBS	325		111	1
1797727	E-8601 E 1.1/4 LBS	350		111	1
1797735	E-8601 E 1.1/2 LBS	365		111	1
1797743	E-8601 E 2 LBS	380		111	1





CLUB HAMMERS

620 E + 620 H

CLUB HAMMER ROTBAND-PLUS

- Forged head DIN 6475
- Contoured ash (620 E) or hickory handle (620 H) DIN 5135, supplementary with long hardened handle protective steel sleeve
- The sleeve, tapered collar, fixing plate and wood screw bond the hammer head and wood handle into one unit
- Patented handle joint, high working safety, long service life, best price-performance ratio



Code	No.	↳mm↳			
8886990	620 E-1000	260	1000	1288	6
8887020	620 E-1250	260	1250	1483	6
8887100	620 E-1500	280	1500	1820	6
8887290	620 E-2000	300	2000	2291	6
8887370	620 H-1000	260	1000	1317	6
8887450	620 H-1250	260	1250	1493	6
8887530	620 H-1500	280	1500	1820	6
8887610	620 H-2000	300	2000	2240	6





E 620 E + E 620 H

SPARE HANDLE ROTBAND-PLUS

- Contoured ash (E 620 E) or hickory handle (E 620 H) DIN 5135
- With hardened handle protective steel sleeve, fixing plate, tapered collar and wood screw
- For all club hammers according to DIN 6475
- With this handle acc. to DIN, every standard DIN club hammer head can be converted to a ROTBAND-PLUS club hammer





Code	No.	↳mm↳		
8678100	E 620 E-1000	260	240	1
8749650	E 620 E-1250	260	230	1
8676670	E 620 E-1500	280	280	1
8676750	E 620 E-2000	300	310	1
8677210	E 620 H-1000	260	270	1
8749730	E 620 H-1250	260	260	1
8677480	E 620 H-1500	280	280	1
8677560	E 620 H-2000	300	350	1

20 E + 20 H

CLUB HAMMER

- Forged head DIN 6475
- With ash (20 E) or hickory handle (20 H) DIN 5135





Code	No.	↳mm↳			
8632460	20 E-1000	260	1000	1196	6
8632540	20 E-1250	260	1250	1388	6
8632620	20 E-1500	280	1500	1704	6
8632700	20 E-2000	300	2000	2176	6
8632890	20 E-3	600	3000	3480	1
8632970	20 E-4	700	4000	4280	1
8633000	20 E-5	800	5000	5750	1
8633190	20 E-6	800	6000	6505	1
8633270	20 E-8	900	8000	9100	1
8633350	20 E-10	900	10000	10880	1
8635210	20 H-1000	260	1000	1220	6
8635480	20 H-1250	260	1250	1406	6
8635560	20 H-1500	280	1500	1740	6
8635640	20 H-2000	300	2000	2275	6
8635720	20 H-3	600	3000	3510	1
8635800	20 H-4	700	4000	4430	1
8635990	20 H-5	800	5000	5890	1
8636020	20 H-6	800	6000	6560	1
8636100	20 H-8	900	8000	9100	1
8636290	20 H-10	900	10000	11040	1

E 20 E + E 20 H

SPARE HANDLE

- Ash (E 20 E, E 9 E) or hickory (E 20 H, E 9 H)
- E 20 acc. to DIN 5135
- E 9 acc. to DIN 5112

Code	No.	for hammer	↳mm↳		
8633940	E 20 E-1000	20-1000, 20-1250, 46-1000, 46-1250	260	151	10
8634160	E 20 E-1500	20-1500, 46-1500	280	131	10
8634240	E 20 E-2000	20-2000, 46-2000	300	178	10
8636880	E 20 H-1000	20-1000, 20-1250	260	163	10
8637180	E 20 H-1500	20-1500	280	136	10
8637260	E 20 H-2000	20-2000	300	210	10
8613080	E 9 E-3	9-3, 10-3, 17-3, 20-3	600	400	1
8613160	E 9 E-4	9-4, 10-4, 17-4, 20-4	700	580	1
8613240	E 9 E-5	9-5, 9-6, 10-5, 10-6, 17-5, 17-6, 20-5, 20-6	800	730	1
8613400	E 9 E-8	9-8, 9-10, 17-8, 17-10, 20-8, 20-10	900	1100	1
8616500	E 9 H-3	9-3, 10-3, 17-3, 20-3	600	400	1
8616690	E 9 H-4	9-4, 10-4, 17-4, 20-4	700	630	1
8616770	E 9 H-5	9-5, 9-6, 10-5, 10-6, 17-5, 17-6, 20-5, 20-6	800	810	1
8616930	E 9 H-8	9-8, 9-10, 17-8, 17-10, 20-8, 20-10	900	960	1

**20 F****CLUB HAMMER**

- ▶ Forged head DIN 6475
- ▶ Nearly unbreakable fibreglass handle with plastic grip and secured head



Code	No.	↳mm↳	↳mm↳	↳mm↳	↳mm↳
8815620	20 F-1000	260	1000	1270	6
8815700	20 F-1250	260	1250	1480	6
8815890	20 F-1500	280	1500	1775	6
8815970	20 F-2000	300	2000	2280	6
8816000	20 F-3	600	3000	3720	1
8866530	20 F-4	700	4000	4750	1
8866610	20 F-5	800	5000	6430	1
8866880	20 F-6	800	6000	7098	1
8866960	20 F-8	900	8000	9100	1
8867180	20 F-10	900	10000	11420	1

20 ST**CLUB HAMMER**

- ▶ Forged head
- ▶ With steel tube handle and plastic grip
- ▶ Very robust and durable



Code	No.	↳mm↳	↳mm↳	↳mm↳	↳mm↳
8640800	20 ST-1000	260	1000	1400	6
8640990	20 ST-1250	260	1250	1570	6

21**SOFT FACE CAP for club hammers**

Code	No.	for club hammer g	↳mm↳	↳mm↳
8641960	21-1000	1000	330	1
8642180	21-1250	1250	375	1
8642260	21-1500	1500	310	1
8642340	21-2000	2000	290	1

646 H**DOUBLE FACED CLUB HAMMER ROTBAND-PLUS Dutch pattern**

- ▶ Forged hammer head
- ▶ Hickory handle DIN 5135, additionally with long hardened handle protective steel sleeve
- ▶ The sleeve, tapered collar, fixing plate and wood screw bond the hammer head and wood handle into one unit
- ▶ Spare handles see club hammer no. 620 H
- ▶ Patented handle join, high working safety, long service life, best price-performance ratio

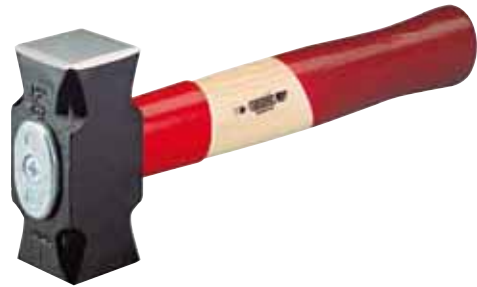

Code	No.	↳mm↳	↳mm↳	↳mm↳	↳mm↳
8683020	646 H-1000	260	1000	1312	6
8682720	646 H-1250	260	1250	1481	6
8682800	646 H-1500	280	1500	1833	6
8682990	646 H-2000	300	2000	2156	6

46 E**DOUBLE FACED CLUB HAMMER Dutch pattern**

- ▶ Forged hammer head
- ▶ With ash handle
- ▶ Spare handles see club hammer No. 20 E



Code	No.	↳mm↳	↳mm↳	↳mm↳	↳mm↳
8667090	46 E-1000	260	1000	1197	6
8667170	46 E-1250	260	1250	1370	6
8667250	46 E-1500	280	1500	1680	6
8667330	46 E-2000	300	2000	2240	6

923 • 924**487****906 • WT 1056 10****587
485**



SLEDGE HAMMERS

609 H

SLEDGE HAMMER ROTBAND-PLUS

- ▶ Forged hammer head DIN 1042
- ▶ Spare handles complete with steel sleeve, tapered collar, fixing plate and wood screw
- ▶ Hickory handle DIN 5112, with additional long and hardened steel sleeve
- ▶ Patented handle join, high working safety, long service life, best price-performance ratio



Code	No.	↳mm↳	↕	↔	📦
8673220	609 H-3	600	3000	3755	1
8673300	609 H-3-90	900	3000	3880	1
8673490	609 H-4	700	4000	4940	1
8673570	609 H-4-90	900	4000	5270	1
8673650	609 H-5	800	5000	6035	1
8673730	609 H-5-90	900	5000	6220	1
8673810	609 H-6	800	6000	7045	1
8674030	609 H-6-90	900	6000	7200	1
8674110	609 H-8	900	8000	9185	1
8674380	609 H-10	900	10000	11150	1



920 · 921 · 922



487

E 609 H

SPARE HANDLE ROTBAND-PLUS

- ▶ Hickory handle DIN 5112
- ▶ Steel sleeve, fixing plate, tapered collar and wood screw
- ▶ For all hammer heads according to DIN 1042
- ▶ With this handle, every standard DIN hammer head can be converted to a ROTBAND-PLUS-sledge hammer



Code	No.	↳mm↳	↕	📦
8681750	E 609 H-3	600	770	1
8740510	E 609 H-3-90	900	990	1
8681910	E 609 H-4	700	840	1
8740780	E 609 H-4-90	900	840	1
8683530	E 609 H-5	800	1120	1
8740860	E 609 H-5-90	900	1082	1
8740350	E 609 H-6	800	900	1
8747950	E 609 H-6-90	900	1100	1
8683610	E 609 H-8	900	1390	1
8740430	E 609 H-10	900	1390	1

9 E + 9 H

SLEDGE HAMMER

- ▶ Forged hammer head DIN 1042
- ▶ With ash (9 E) or hickory handle (9 H) DIN 5112



Code	No.	↳mm↳	↕	↔	📦
8612000	9 E-3	600	3000	3330	1
8809220	9 E-3-90	900	3000	3450	1
8612190	9 E-4	700	4000	4365	1
8809490	9 E-4-90	900	4000	4410	1
8612270	9 E-5	800	5000	5535	1
8809650	9 E-5-90	900	5000	5495	1
8612350	9 E-6	800	6000	6590	1
8809810	9 E-6-90	900	6000	6570	1
8612430	9 E-8	900	8000	8650	1
8612510	9 E-10	900	10000	10560	1
8615370	9 H-3	600	3000	3515	1
8812360	9 H-3-90	900	3000	3705	1
8615450	9 H-4	700	4000	4710	1
8812440	9 H-4-90	900	4000	5040	1
8615530	9 H-5	800	5000	5760	1
8812520	9 H-5-90	900	5000	5800	1
8615610	9 H-6	800	6000	6680	1
8812600	9 H-6-90	900	6000	6795	1
8615880	9 H-8	900	8000	8815	1
8615960	9 H-10	900	10000	10895	1

E 9 E + E 9 H

SPARE HANDLE

- ▶ Ash (E 9 E) or hickory (E 9 H)
- ▶ Acc. to DIN 5112
- ▶ Execution -90 = 90 cm handle

Code	No.	for hammer	↳mm↳	↕	📦
8613080	E 9 E-3	9-3, 10-3, 17-3, 20-3	600	400	1
8784210	E 9 E-3-90	9-3, 9-4	900	660	1
8613160	E 9 E-4	9-4, 10-4, 17-4, 20-4	700	580	1
8613240	E 9 E-5	9-5, 9-6, 10-5, 10-6, 17-5, 17-6, 20-5, 20-6	800	730	1
8784480	E 9 E-5-90	9-5, 9-6	900	840	1
8613400	E 9 E-8	9-8, 9-10, 17-8, 17-10, 20-8, 20-10	900	1100	1
8616500	E 9 H-3	9-3, 10-3, 17-3, 20-3	600	400	1
8786180	E 9 H-3-90	9-3, 9-4	900	790	1
8616690	E 9 H-4	9-4, 10-4, 17-4, 20-4	700	630	1
8616770	E 9 H-5	9-5, 9-6, 10-5, 10-6, 17-5, 17-6, 20-5, 20-6	800	810	1
8786260	E 9 H-5-90	9-5, 9-6	900	700	1
8616930	E 9 H-8	9-8, 9-10, 17-8, 17-10, 20-8, 20-10	900	960	1



Deviant packing units see article description.

**9 F****SLEDGE HAMMER**

- ▶ Forged hammer head DIN 1042
- ▶ With fibreglass handle, with secured head



Code	No.	↳mm↳			
8614130	9 F-3	600	3000	3665	1
8820380	9 F-3-90	900	3000	3955	1
8614210	9 F-4	700	4000	4930	1
8820890	9 F-4-90	900	4000	5050	1
8614480	9 F-5	800	5000	6370	1
8820970	9 F-5-90	900	5000	6420	1
8614560	9 F-6	800	6000	7165	1
8821000	9 F-6-90	900	6000	7230	1
8614640	9 F-8	900	8000	9280	1
8614720	9 F-10	900	10000	11260	1

10 E + 10 H**SLEDGE HAMMER**

- ▶ Forged hammer head DIN 1042
- ▶ With ash (10 E) or hickory handle (10 H) DIN 5112



Code	No.	↳mm↳	Spare handle			
8620530	10 E-3	600	E 9 E-3	3000	3375	1
8620610	10 E-4	700	E 9 E-4	4000	4540	1
8620880	10 E-5	800	E 9 E-5	5000	5925	1
8620960	10 E-6	800	E 9 E-5	6000	6925	1
8621500	10 H-3	600	E 9 H-3	3000	3475	1
8621690	10 H-4	700	E 9 H-4	4000	4610	1
8621770	10 H-5	800	E 9 H-5	5000	5755	1
8621850	10 H-6	800	E 9 H-5	6000	6835	1

17 E**STONE SLEDGE HAMMER**

- ▶ Hammer head forged with sharp cutting edge
- ▶ With ash handle DIN 5112



Code	No.	↳mm↳	Spare handle			
8627540	17 E-3	600	E 9 E-3	3000	3310	1
8627620	17 E-4	700	E 9 E-4	4000	4670	1
8627700	17 E-5	800	E 9 E-5	5000	5670	1
8627890	17 E-6	800	E 9 E-5	6000	6530	1
8627970	17 E-8	900	E 9 E-8	8000	8730	1
8628000	17 E-10	900	E 9 E-8	10000	10870	1

BRICKLAYER'S HAMMERS**29 E****BRICKLAYER'S HAMMER Rhineland pattern**

- ▶ Head only (29) or with ash handle (29 E)
- ▶ Spare handle E 29 E



Code	No.	↳mm↳			
8656210	29-500		500	480	6
8656480	29-600		600	590	6
8656990	29 E-500	300	500	580	6
8657020	29 E-600	300	600	710	6
8657100	E 29 E-500	300		200	10

29 ST**BRICKLAYER'S HAMMER Rhineland pattern**

- ▶ With steel tube handle and plastic grip
- ▶ Very robust and durable



Code	No.	↳mm↳			
8657370	29 ST	270	500	790	6

30 E**BRICKLAYER'S HAMMER Dutch pattern**

- ▶ With ash handle
- ▶ Spare handle E 30 E



Code	No.	↳mm↳			
8657530	30 E-500	300	500	610	6
8657610	30 E-700	350	700	970	6
8657880	E 30 E-500	300		140	10
8657960	E 30 E-700	350		140	10





94 E

BRICKLAYER'S HAMMER Berlin pattern

- ✔ With ash handle
- ✔ Spare handle E 94 E



Code	No.	↳mm↳			
8696940	94 E-600	280	600	790	6
8697080	E 94 E-600	280		120	10





CARPENTER'S HAMMERS

75 GSTM

CARPENTER'S HAMMER

- ✔ Head and handle forged in one piece, nearly unbreakable
- ✔ Ergonomic, air-cushioned 2-component handle
- ✔ Optimum impact force - a result of its perfect balance
- ✔ Fatigue-free working due to the new anti-vibration system
- ✔ With straight-through shaft right to the end of the handle
- ✔ With magnetic nail holder





Code	No.	↳mm↳		
1576143	75 GSTM	340	873	6

94 ST

BRICKLAYER'S HAMMER Berlin pattern

- ✔ With steel tube handle and plastic grip
- ✔ Very robust and durable





Code	No.	↳mm↳			
8697240	94 ST	270	600	891	6

93 ST

BUILDER'S HATCHET

- ✔ With steel tube handle and plastic grip
- ✔ Very robust and durable



Code	No.	↳mm↳			
8696510	93 ST	300	600	909	6

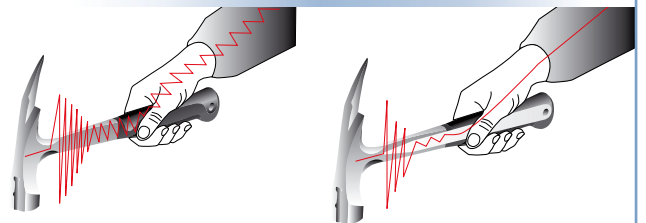

- ✔ The anti-vibration system of the 75 GSTM and 71 GSTM allows safe, powerful hammer blows
- ✔ With conventional all-steel hammers, jarring vibrations are transmitted through to the user's arm on every impact



WT 1056 7



485



575 F + 575 FM

CARPENTER'S HAMMER

- ▶ Nearly unbreakable fibreglass handle with plastic grip and secured head
- ▶ With hardened handle protective steel sleeve
- ▶ 575 F without magnet
- ▶ 575 FM with magnet



Code	No.	mm	mm	mm	
8863350	575 F	300	600	840	6
8863430	575 FM	300	600	810	6

75 ST + 75 STM

CARPENTER'S HAMMER

- ▶ With steel tube handle and plastic grip
- ▶ Acc. to DIN 7239
- ▶ 75 ST without magnet
- ▶ 75 STM with magnet
- ▶ Very robust and durable



Code	No.	mm	mm	mm	
8688920	75 ST	300	600	851	6
8689220	75 STM	300	600	835	6

75 STK + 75 STKM

CARPENTER'S HAMMER

- ▶ With steel tube handle, plastic grip and secured head
- ▶ Acc. to DIN 7239
- ▶ 75 STK without magnet
- ▶ 75 STKM with magnet
- ▶ Very robust and durable



Code	No.	mm	mm	mm	
8692440	75 STK	300	600	839	6
8813090	75 STKM	300	600	847	6

CLAW HAMMERS

71 GSTM

CLAW HAMMER, AMERICAN PATTERN

- ▶ Head and handle forged in one piece, nearly unbreakable
- ▶ Ergonomic, air-cushioned 2-component handle
- ▶ Optimum impact force - a result of its perfect balance
- ▶ Fatigue-free working due to the new anti-vibration system
- ▶ With straight-through shaft right to the end of the handle
- ▶ With magnetic nail holder



Code	No.	mm	oz	mm	
1629670	71 GSTM	27	20	823	6

HAMMERS MISCELLANEOUS

79

BRICK BOLSTER

- ▶ Made from special steel



Code	No.	mm	mm	
8692010	79-60	60	570	1
8692280	79-80	80	720	1
8692360	79-100	100	990	1

35 H

PAVING HAMMER Berlin pattern

- ▶ With hickory handle
- ▶ Spare handle E 35 H



Code	No.	mm	mm	mm	
1488295	35 H-1000	175	1000	1088	6
1488309	35 H-1500	175	1500	1690	6
1488317	35 H-2000	175	2000	2298	6
1476718	E 35 H-1000	175		94	10
1476726	E 35 H-1500	175		105	10
1476734	E 35 H-2000	175		112	10





18 E

PAVING HAMMER SQUARE

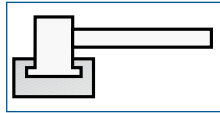
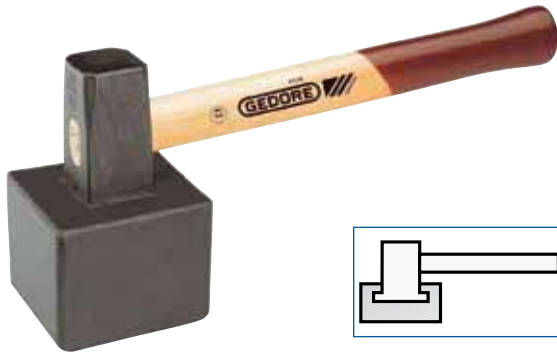
- ✔ With welded plate and large vulcanised rubber block
- ✔ With ash handle
- ✔ Spare handle E 18 E





Code	No.	↳mm↳			
8883700	18 E	360	2525		1
8883890	E 18 E	360	345		1

19 E

PAVING HAMMER ROUND

- ✔ With welded plate and large vulcanised rubber block
- ✔ With ash handle
- ✔ Spare handle E 18 E





Code	No.	↳mm↳			
1628216	19 E	360	2130		1
8883890	E 18 E	360	345		1

43 E

VENEER HAMMER

- ✔ With ash handle DIN 5111
- ✔ Spare handle E 4 E



Code	No.	↳mm↳	mm			
8665630	43 E-500	320	90	500	590	6
8588380	E 4 E-500	320			160	10



WT 1056 10





485

212 E

CARBIDE TILE HAMMER pointed or flat

- ✔ Striking face not hardened
- ✔ With ash handle and handle protective sleeve
- ✔ Execution FL = flat
- ✔ Execution SP = pointed





Code	No.	↳mm↳			
8882730	212 E-50 FL	280	50	114	6
8749490	212 E-75 FL	280	75	130	6
8882810	212 E-50 SP	280	50	560	6
8749570	212 E-75 SP	280	75	140	6

213 H - 214 H

TILE HAMMER pointed or flat

- ✔ Head made from chrome-vanadium steel
- ✔ Face hardened and tempered
- ✔ With hickory handle, handle protective sleeve and safety screw for a durable safe connection of handle and hammer head
- ✔ With point (213 H) or edge (214 H)





Code	No.	↳mm↳			
8916300	213 H-50	290	50	113	6
8926960	213 H-75	290	75	139	6
8916490	214 H-50	290	50	114	6
8927180	214 H-75	290	75	170	6

72 H

GLAZIERS HAMMER polished

- ✔ With hickory handle, steel sleeve and safety screw for a durable safe connection of handle and hammer head



Code	No.	↳mm↳			
1541935	72 H-100	300	100	212	6
1541730	E 72 H-100	300		40	10



570 H

MAGNETIC HAMMER ROTBAND

- ▶ Hickory handle with hardened handle protective steel sleeve
- ▶ With magnet
- ▶ Spare handle E 500 H-100



Code	No.	[-mm-]			
8856490	570 H	300	100	900	6
2015684	E 570 H-100	260		48	10

77 E

SCALING HAMMER

- ▶ With ash handle DIN 5111
- ▶ Spare handle E 4 E



Code	No.	[-mm-]			
8690900	77 E-300	300	330	390	6
8588030	E 4 E-300	300		99	10

76 ST

GEOLOGIST'S HAMMER

- ▶ With very robust and durable steel tube handle with plastic grip
- ▶ Execution SCH with cutting edge
- ▶ Execution SP with pointed tip



Code	No.	[-mm-]			
8855330	76 ST SCH	300	500	780	6
8855410	76 ST SP	300	500	770	6

77 ST

SCALING HAMMER

- ▶ With steel tube handle



Code	No.			
8691390	77 ST-400	400	505	6

SCALING HAMMERS

677 H

SCALING HAMMER ROTBAND-PLUS

- ▶ Forged hammer head
- ▶ Contoured hickory handle DIN 5111 with additional long, hardened steel sleeve
- ▶ The sleeve, tapered collar, fixing plate and wood screw bond the hammer head and wood handle into one unit
- ▶ Patented handle join, high working safety, long service life, best price-performance ratio



Code	No.	[-mm-]			
8671950	677 H	300	300	450	6
1822357	E 677 H-300	300		150	10

41 E

SCALING HAMMER

- ▶ With ash handle DIN 5111
- ▶ Spare handle E 4 E



Code	No.	[-mm-]			
8665390	41 E-500	320	500	640	6
8588380	E 4 E-500	320		160	10



RECOILLESS HAMMERS

- Due to the special filling insert in the hammer head a considerable higher striking effect is reached compared to standard engineers' and recoilless hammers
- Universal use for service and assembly work, with all advantages of a recoilless hammer with higher striking effect
- "Dead blows" with no recoil reduces stress on muscles, nerves and wrists
- Reduction in expenses due to universal use as an engineer's and recoilless hammer
- Recoilless hammers improve effect of impact and so protect sensitive surfaces
- Each blow is up to 100% more effective than standard safety hammers
- Available with hickory, tubular steel or fibreglass handles
- Exchangeable inserts, resistant to breakage or wear, made of modified polyamide

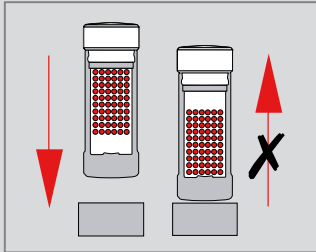

248 F

RECOILLESS HAMMER

- Nearly unbreakable fibreglass handle with handy plastic grip and secured head
- Splinter-proof, shatter-proof and wear-resistant polyamide heads, 75 Shore D
- Powder-coated with silver hammer-effect enamel

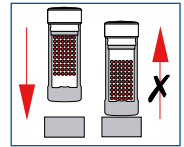

Code	No.	↳mm↳	Ø mm	↕	📦
8724310	248 F-25	290	25	400	6
8867690	248 F-30	305	30	550	6
8867770	248 F-35	310	35	730	6
8867850	248 F-40	315	40	780	6
8867930	248 F-45	320	45	940	6
8868070	248 F-50	325	50	1120	1
8868150	248 F-60	335	60	1680	1

248 H

RECOILLESS HAMMER

- With hickory handle
- Splinter-proof, shatter-proof and wear-resistant polyamide heads, 75 Shore D
- Powder-coated with silver hammer-effect enamel

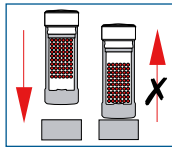

Code	No.	↳mm↳	Ø mm	↕	📦
8728220	248 H-25	305	25	300	6
8868230	248 H-30	330	30	470	6
8868310	248 H-35	335	35	590	6
8868580	248 H-40	360	40	730	6
8868660	248 H-45	365	45	870	6
8868740	248 H-50	370	50	1020	1
8868820	248 H-60	370	60	1650	1
8728300	248 H-70	370	70	2330	1
8728490	248 H-80	880	80	4270	1
8728570	248 H-100	1000	100	6935	1

E 248 H

SPARE HANDLE HICKORY

Code	No.	↳mm↳	↕	📦
8739690	E 248 H-25	280	62	10
8739770	E 248 H-30-35	300	120	10
8739850	E 248 H-40-45	320	140	10
8739930	E 248 H-50	320	180	10
8740000	E 248 H-60-70	310	210	10
8740190	E 248 H-80	800	680	10
8740270	E 248 H-100	900	1100	10

248 ST

RECOILLESS HAMMER

- With very robust and durable steel tube handle
- Splinter-proof, shatter-proof and wear-resistant polyamide heads, 75 Shore D, tested to -20° C
- Powder-coated with silver hammer-effect enamel

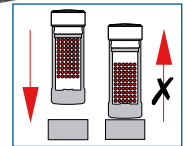

Code	No.	↳mm↳	Ø mm	↕	📦
8724070	248 ST-25	270	25	440	6
8828950	248 ST-30	290	30	590	6
8829090	248 ST-35	295	35	710	6
8829170	248 ST-40	300	40	810	6
8829410	248 ST-45	305	45	980	6
8829250	248 ST-50	310	50	1070	1
8829330	248 ST-60	335	60	1790	1
8724150	248 ST-70	335	70	2430	1

E 248

SPARE HEAD (PIECE)

- Splinter-proof, shatter-proof and wear-resistant polyamide

Code	No.	Ø mm	↕	📦
8747790	E 248-20	20	10	1
8747870	E 248-25	25	10	1
8830260	E 248-30	30	15	1
8830340	E 248-35	35	21	1
8830420	E 248-40	40	31	1
8829920	E 248-45	45	40	1
8830500	E 248-50	50	50	1
8830690	E 248-60	60	90	1
8748410	E 248-70	70	130	1
8748680	E 248-80	80	190	1
8748760	E 248-100	100	350	1



248 KL

RECOILLESS IMPACT TOOL

- Splinter-proof, shatter-proof and wear-resistant polyamide heads
- Powder-coated with silver hammer-effect enamel

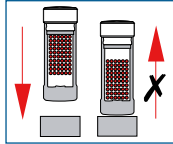

Code	No.	↳mm↳	Ø mm	↕	☞
8746980	248 KL-20	150	20	220	1
8747010	248 KL-25	154	25	310	1
8747280	248 KL-30	155	30	440	1
8747360	248 KL-35	155	35	610	1
8747440	248 KL-40	160	40	790	1
8747520	248 KL-45	160	45	1010	1
8747600	248 KL-50	165	50	1230	1

VS 247 H

DISPLAY RACK FOR HAMMER KOMBI-PLUS R 11 pieces

- High-quality and compact



Code	No.	Contents	↕	☞
1648985	VS 247 H	6x 247 H-30 5x 247 H-35	11.0	1



KOMBI-PLUS R

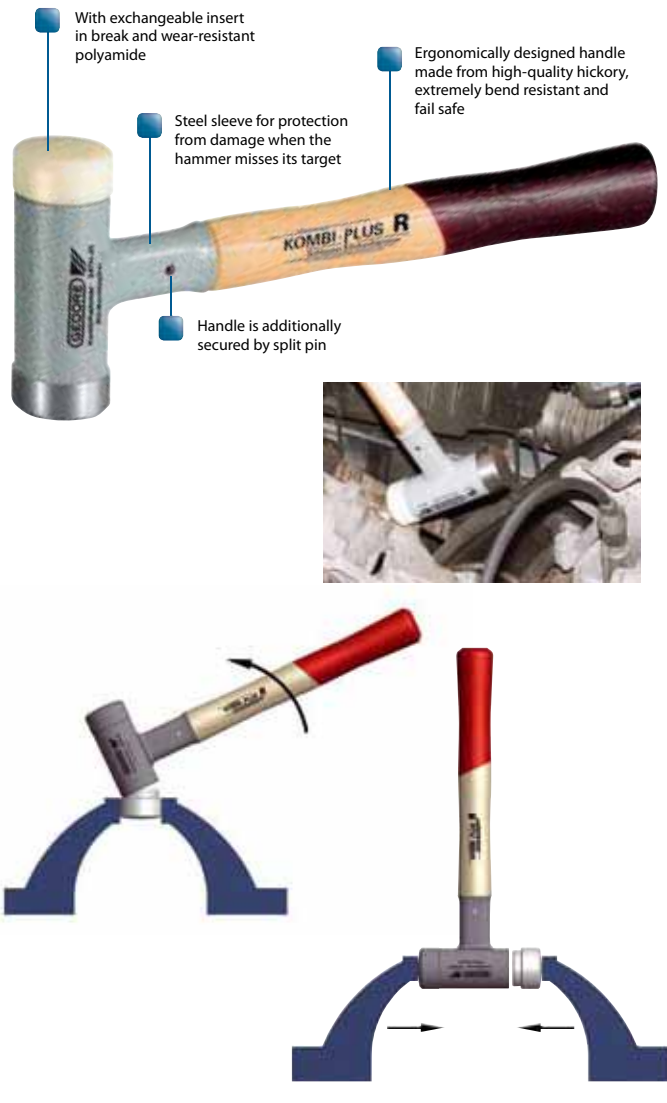

247 H

COMBINATION HAMMER KOMBI-PLUS R

- Reduced expense due to versatile use as an engineer's and recoilless hammer
- Universal use for service and assembly work
- With all advantages of a recoilless hammer with higher striking effect
- Less energy necessary, easier working
- With exchangeable insert in break and wear-resistant modified polyamide (E 247), 75 Shore D
- With hickory handle
- Spare handle E 247 H
- DBGM (German utility patent)

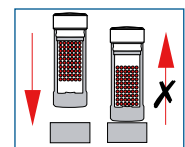

Code	No.	↳mm↳	Ø mm	↕	☞
1603299	247 H-30	305	30	460	6
1885979	247 H-30-200	200	30	480	6
1603396	247 H-35	310	35	690	6
1687883	247 H-40	330	40	840	6
1605313	E 247 H-30	270		100	1
1630709	E 247 H-35	270		120	1
1688014	E 247 H-40	290		126	1
1605305	E 247-30		30	21	1
1605380	E 247-35		35	34	1
1688022	E 247-40		40	40	1



SAFETY HAMMER SOFT-PLUS

SOFT-PLUS heads

✔ **Blue (B) = soft, 20 Shore D**

- Material: Elastomer
- For sensitive work pieces, light metal production, furniture industry, assembly works, etc.

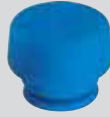

✔ **Black (S) = medium soft, 45 Shore D**

- Material: Caoutchouc
- For sturdy applications, pavement craft, etc.



✔ **Yellow (G) = medium hard, 63 Shore D**

- Material: Polyurethane
- For universal applications, tooling and machine industry, automotive workshops, sheet metal work, etc.



✔ **Anthracite (A) = hard, 70 Shore D**

- Material: Polyurethane
- For high striking power, road building, etc.



250

SAFETY HAMMER SOFT-PLUS

- ✔ Safety hammer with malleable cast iron shells
- ✔ With hickory handle and interchangeable heads
- ✔ Slots in the head and grooves in the shells provide an absolute safe connection
- ✔ The screw is guided through the handle and connected with a self-locking nut. This provides highest safety



Code	No.	h mm	l mm	Ø mm	W mm	W
1446010	250 AB-30	87	290	30	321	6
1446029	250 AB-40	110	325	40	660	6
1446037	250 AB-50	131	360	50	1100	6
1445936	250 AG-30	87	290	30	335	6
1445960	250 AG-40	110	325	40	656	6
1445979	250 AG-50	131	360	50	1140	6
1446088	250 AS-30	87	290	30	386	6
1446118	250 AS-40	110	325	40	690	6
1446134	250 AS-50	131	360	50	1135	6
1445898	250 BG-30	87	290	30	328	6
1445901	250 BG-40	110	325	40	646	6
1445928	250 BG-50	131	360	50	1102	6
1446045	250 BS-30	87	290	30	328	6
1446053	250 BS-40	110	325	40	658	6
1446061	250 BS-50	131	360	50	1110	6
1445987	250 GS-30	87	290	30	335	6
1445995	250 GS-40	110	325	40	671	6
1446002	250 GS-50	131	360	50	1130	6

E 250

SPARE HEAD SOFT-PLUS

- ✔ For safety hammer 250
- ✔ Splinter-proof, shatter-proof, wear-resistant
- ✔ Colour fast
- ✔ Cadmium free



Code	No.	Ø mm	W mm	W
1445200	E 250 A-30	30	27	1
1445219	E 250 A-40	40	58	1
1445227	E 250 A-50	50	116	1
1445111	E 250 B-30	30	20	1
1445154	E 250 B-40	40	45	1
1445162	E 250 B-50	50	85	1
1445170	E 250 G-30	30	26	1
1445189	E 250 G-40	40	60	1
1445197	E 250 G-50	50	116	1
1445235	E 250 S-30	30	30	1
1445243	E 250 S-40	40	70	1
1445251	E 250 S-50	50	115	1

E 250 H

SPARE HANDLE SOFT-PLUS

- ✔ For safety hammer no. 250
- ✔ Made from hickory



Code	No.	l mm	W mm	W
1445715	E 250 H-30	275	90	10
1445723	E 250 H-40	300	132	10
1445758	E 250 H-50	330	176	10

E 250 T

MALLEABLE CAST IRON SHELLS SOFT-PLUS

- ✔ For safety hammer no. 250, 1 pair
- ✔ Made from high-quality malleable cast iron
- ✔ Safety connection included
- ✔ Extremely resistant



Code	No.	Ø mm	W mm	W
1445073	E 250 T-30	30	160	1
1445081	E 250 T-40	40	365	1
1445103	E 250 T-50	50	710	1



SAFETY HAMMERS

224 E

PLASTIC HAMMER

- With exchangeable heads made from yellow shatter-proof cellulose acetate
- With ash handle
- 65 Shore D



Code	No.	l mm	Ø mm	W mm	W mm
8821270	224 E-22	250	22	157	6
8821350	224 E-27	270	27	242	6
8821430	224 E-32	280	32	365	6
8821510	224 E-35	290	35	445	6
8821780	224 E-40	320	40	600	6
8821860	224 E-50	340	50	913	6
8821940	224 E-60	380	60	1392	6

Code	Spare head No.	Ø mm	W mm	W mm
8822590	E 224-22	22	5	1
8822670	E 224-27	27	15	1
8822750	E 224-32	32	25	1
8822830	E 224-35	35	30	1
8822910	E 224-40	40	40	1
8823050	E 224-50	50	70	1
8823130	E 224-60	60	110	1

225 E

NYLON HAMMER

- With exchangeable heads made from impact-resistant nylon
- With ash handle
- 60 Shore D



Code	No.	l mm	Ø mm	W mm	W mm
8805310	225 E-22	250	22	160	6
8805580	225 E-27	270	27	250	6
8805660	225 E-32	280	32	350	6
8805740	225 E-35	290	35	420	6
8805820	225 E-40	320	40	580	6
8805900	225 E-50	340	50	900	6
8806040	225 E-60	380	60	1340	6

Code	Spare head No.	Ø mm	W mm	W mm
8814220	E 225-22	22	5	1
8814300	E 225-27	27	10	1
8814490	E 225-32	32	15	1
8814570	E 225-35	35	25	1
8814650	E 225-40	40	30	1
8814730	E 225-50	50	55	1
8814810	E 225-60	60	85	1

E 224 E

SPARE HANDLE for no. 224+225

Code	No.	l mm	W mm	W mm
8823210	E 224 E-22	250	60	10
8823480	E 224 E-27	270	60	10
8823560	E 224 E-32	280	80	10
8823640	E 224 E-35	290	60	10
8823720	E 224 E-40	320	100	10
8824290	E 224 E-50	340	100	10
8824370	E 224 E-60	380	115	10

226 E

RUBBER MALLET hard

- DIN 5128-90, 90 Shore A
- With two flat surfaces
- 2 A** with one curved and one flat surface
- With ash handle



Code	No.	l mm	l mm	Ø mm	W mm	W mm
8825500	226 E-0	80	260	40	210	6
8825690	226 E-1	90	320	55	370	6
8825770	226 E-2	115	340	65	630	6
8825850	226 E-2 A	115	340	65	578	6
8825930	226 E-3	130	380	75	990	6
8826070	226 E-4	140	380	90	1460	6

227 E

RUBBER MALLET soft

- DIN 5128-60, 60 Shore A
- With two flat surfaces
- 2 A** with one curved and one flat surface
- With ash handle



Code	No.	l mm	l mm	Ø mm	W mm	W mm
8826660	227 E-0	80	260	40	150	6
8826740	227 E-1	90	320	55	320	6
8826820	227 E-2	115	340	65	540	6
8826900	227 E-2 A	115	340	65	430	6
8827040	227 E-3	130	380	75	770	6
8827120	227 E-4	140	380	90	1050	6

E 226 E

SPARE HANDLE ASH for no. 226+227

Code	No.	l mm	W mm	W mm
8826230	E 226 E-0	260	43	10
8826310	E 226 E-1	320	45	10
8826580	E 226 E-2	340	100	10
8827200	E 226 E-3	380	130	10
8827390	E 226 E-4	380	170	10

216 K

PLASTIC HAMMER

- Colour leaves no stains, smears or other marks on the working materials or components
- White side PVC = soft, approx. 70 Shore
- Blue side PP = hard, approx. 95 Shore
- With plastic handle



Code	No.	l mm	Ø mm	l mm	W mm	W mm
1468286	216 K-1	85	55	320	260	6
1468294	216 K-2	110	60	340	403	6



WOODEN / COPPER / LEAD HAMMERS

228

WOODEN MALLET

- ✔ Made from white beech wood
- ✔ Acc. to DIN 7462 A



Code	No.	↳ mm ↳	Ø mm	↳ mm ↳	↳ mm ↳
8828010	228-60	300	60	350	6
8828280	228-70	340	70	470	6

229

WOODEN MALLET

- ✔ Head made from white beech wood with pressed steel holder
- ✔ With oval ash handle
- ✔ Acc. to DIN 7462 B



Code	No.	↳ mm ↳	Ø mm	↳ mm ↳	↳ mm ↳
8601230	229-60	310	60	340	6
8601310	229-70	320	70	610	6
8605060	229-80	350	80	820	6

21 F

LIGHT METAL HAMMER

- ✔ Cylindrical pattern
- ✔ Nearly unbreakable fibreglass handle with plastic grip



Code	No.	↳ mm ↳	Ø mm	↳ mm ↳	↳ mm ↳
2015110	21 F-250	300	40	250	440
2015129	21 F-500	320	45	500	710
2015137	21 F-1000	360	60	1000	1250
2015145	21 F-1500	400	70	1500	1790

223 H

LEAD HAMMER

- ✔ Barrel shape, with end-to-end split pin
- ✔ With hickory handle DIN 5111
- ✔ Spare handle E 4 H



Code	No.	↳ mm ↳	↳ mm ↳	↳ mm ↳	↳ mm ↳
8820460	223 H-1000	310	1000	1160	6
8820540	223 H-1500	350	1500	1840	6
8591760	E 4 H-400	310		120	10
8592060	E 4 H-800	350		210	10

622 H

COPPER HAMMER ROTBAND-PLUS

- ✔ Club shape
- ✔ With hickory handle DIN 5111, with additional long hardened handle protective steel sleeve
- ✔ Spare handle E 600 H
- ✔ The sleeve, tapered collar, fixing plate and wood screw bond the hammer head and wood handle into one unit
- ✔ Patented handle join, high working safety, long service life, best price-performance ratio



Code	No.	↳ mm ↳	↳ mm ↳	↳ mm ↳	↳ mm ↳
8672410	622 H-750	350	750	1120	6
8672680	622 H-1000	360	1000	1468	6
8672760	622 H-1500	380	1500	2075	6
8672840	622 H-2000	400	2000	2300	6
8596640	E 600 H-800	350		296	10
8597880	E 600 H-1000	360		315	10
8597960	E 600 H-1500	380		373	10
8599070	E 600 H-2000	400		442	10

22 H

COPPER HAMMER

- ✔ Club shape
- ✔ Forged hammer head with accurate chamfer
- ✔ With hickory handle DIN 5111
- ✔ Spare handle E 4 H



Code	No.	↳ mm ↳	↳ mm ↳	↳ mm ↳	↳ mm ↳
1583999	22 H-250	280	250	316	6
1584006	22 H-500	310	500	715	6
8867260	22 H-750	350	750	1050	6
8867340	22 H-1000	360	1000	1333	6
8867420	22 H-1500	380	1500	1933	6
8867500	22 H-2000	400	2000	2341	6
8591410	E 4 H-200	280		85	10
8591760	E 4 H-400	310		120	10
8592060	E 4 H-800	350		210	10
8592140	E 4 H-1000	360		225	10
8592220	E 4 H-1500	380		190	10
8592300	E 4 H-2000	400		280	10

23 E

COPPER HAMMER

- ✔ Club shape
- ✔ With ash handle DIN 5111
- ✔ Spare handle E 4 E



Code	No.	↳ mm ↳	↳ mm ↳	↳ mm ↳	↳ mm ↳
1599275	23 E-250	300	250	333	6
1599585	23 E-500	320	500	689	6
1599593	23 E-750	350	750	950	6
1599607	23 E-1000	360	1000	1141	6
1599623	23 E-1500	380	1500	1991	6
1599631	23 E-2000	400	2000	2282	6



Code	No.	mm	mm	mm	mm
8588030	E 4 E-300	300		99	10
8588380	E 4 E-500	320		160	10
8588540	E 4 E-800	350		165	10
8588620	E 4 E-1000	360		183	10
8588700	E 4 E-1500	380		196	10
8588890	E 4 E-2000	400		261	10

FORGING TOOLS

37 E

COLD CHISEL HAMMER

- With ash handle
- Spare handle E 37 E



Code	No.	mm	mm	mm	mm
8663850	37 E-1500	600	1500	1810	1
8663930	E 37 E-1500	600		270	1

38 E

HOT CHISEL HAMMER

- With ash handle
- Spare handle E 37 E



Code	No.	mm	mm	mm	mm
8664310	38 E-1500	600	1500	1760	1
8663930	E 37 E-1500	600		270	1

48 E

SQUARE FLATTER

- With ash handle
- Spare handle E 37 E



Code	No.	mm	mm	mm	mm
8669620	48 E-70	70	600	1600	2240
8663930	E 37 E-1500	600		270	1



Deviant packing units see article description.

49 E

SET HAMMER

- With ash handle
- Spare handle E 37 E



Code	No.	mm	mm	mm	mm
8670120	49 E-50	50	600	1900	2400
8663930	E 37 E-1500	600		270	1

50

BOTTOM ANVIL TOOL

- Pin 25 mm



Code	No.	mm	mm	mm
8670550	50-50	50		1030

51 E

TOP FULLER

- With ash handle
- Spare handle E 37 E



Code	No.	mm	mm	mm	mm
8671520	51 E-15	15	600	900	1310
8671600	51 E-20	20	600	950	1330
8663930	E 37 E-1500	600		270	1

53

BOTTOM FULLER

- Pin 25 mm



Code	No.	mm	mm	mm
8672090	53-15	15		1140
8672170	53-20	20		1132

920 • 921 • 922



487





54 E

TOP SWAGE

- ✔ With ash handle
- ✔ Spare handle E 37 E





Code	No.	■ mm	↳ mm ↵			
8676830	54 E-10	10	600	1000	1290	1
8676910	54 E-15	15	600	1225	1480	1
8677050	54 E-20	20	600	1695	2050	1
8677130	54 E-25	25	600	1850	2120	1
8663930	E 37 E-1500		600		270	1

55

BOTTOM SWAGE

- ✔ Pin 25 mm





Code	No.	■ mm	↳ mm ↵		
8677720	55-10	10		1050	1
8677800	55-15	15		1090	1
8677990	55-20	20		1100	1
8678020	55-25	25		1052	1

56 E

PUNCH HAMMER

- ✔ With ash handle
- ✔ Spare handle E 37 E
- ✔ Can be supplied with rebound-dampened tubular steel handle



Code	No.	○ mm	↳ mm ↵			
8679500	56 E-10	10	600	850	1010	1
8679690	56 E-15	15	600	1000	1480	1
8679770	56 E-20	20	600	1470	1770	1
8663930	E 37 E-1500		600		270	1

58

HARDY

- ✔ Pin 25 mm



Code	No.	↳ mm ↵	
8680350	58-100	1190	1

59

ANVIL HORN

- ✔ Pin 25 mm





Code	No.	↳ mm ↵	
8680780	59-100	1100	1

60 E - 61 E

SCYTHE HAMMER

- ✔ 60 E = double edge with ash handle
- ✔ 61 E = single edge with ash handle
- ✔ Spare handle E 60 E



Code	No.	↳ mm ↵			
8681160	60 E-500	240	500	630	6
8681400	61 E-500	240	500	610	6
8681590	E 60 E-500	240		120	10

62 - 63

SCYTHE ANVIL



Code	No.	Execution	↳ mm ↵	
8681830	62-500	tipped	390	1
8682050	63-500	edged	560	1

923 · 924



487



BLACKSMITH'S TONGS

230

BLACKSMITH'S TONGS

Flat nosed



Code	No.	mm	mm	
8842510	230-300	300	500	1
8842780	230-400	400	860	1
8842860	230-500	500	1240	1
8842940	230-600	600	1710	1

231

BLACKSMITH'S TONGS

Round nosed



Code	No.	mm	mm	
8843400	231-300	300	580	1
8843590	231-400	400	870	1
8843670	231-500	500	1220	1
8843750	231-600	600	1610	1

232

BLACKSMITH'S TONGS

Half-round nosed



Code	No.	mm	mm	
8844210	232-300	300	590	1
8844480	232-400	400	796	1
8844560	232-500	500	1230	1
8844640	232-600	600	1630	1

233

BLACKSMITH'S TONGS

Half-round nosed



Code	No.	mm	mm	
8845100	233-300	300	610	1
8845290	233-400	400	930	1
8845370	233-500	500	1320	1
8845450	233-600	600	1790	1

234

RIVETTING TONGS



Code	No.	mm	mm	
8846180	234-400	400	500	1
8846260	234-500	500	850	1



SCRAPERS

130

THREE-EDGED BEARING SCRAPER

- Made from special steel
- Working ends polished
- With wooden handle
- Flanged blade



Code	No.	Spoon	mm	mm	mm	
8777270	130-125	55	125	225	78	10
8777350	130-150	70	150	270	136	10
8777430	130-200	85	200	315	171	10
8777510	130-250	100	250	365	182	10

131

CURVED BEARING SCRAPER (LONG SCRAPER) American pattern

- Made from special steel
- Working ends polished
- With wooden handle
- Flanged blade



Code	No.	Spoon	mm	mm	mm	
8778160	131-125	45	125	225	90	10
8778240	131-150	65	150	270	124	10
8778320	131-200	85	200	315	100	10
8778400	131-250	105	250	365	217	10







132

THREE-EDGED HOLLOW GROUND SCRAPER

- ▶ Acc. to DIN 8350 Form C
- ▶ Made from special steel
- ▶ Working ends polished
- ▶ With wooden handle
- ▶ Flanged blade







Code	No.				
8778910	132-100	100	200	77	10
8779050	132-125	125	225	880	10
8779130	132-150	150	270	100	10
8779210	132-175	175	295	151	10
8779480	132-200	200	315	163	10
8779560	132-250	250	365	185	10
8779640	132-300	300	415	210	10

133 F

FLAT SCRAPER

- ▶ Acc. to DIN 8350 Form A
- ▶ Made from special steel
- ▶ Working ends polished
- ▶ With wooden handle
- ▶ Flanged blade



Code	No.				
8780220	133 F-100	100	200	107	10
8780300	133 F-125	125	225	108	10
8780490	133 F-150	150	270	190	10
8780570	133 F-175	175	295	208	10
8780650	133 F-200	200	315	234	10
8780730	133 F-250	250	365	390	10
8780810	133 F-300	300	415	420	10

Safety instruction for scrapers

Do not touch the sharp working edges.

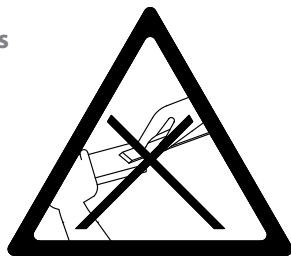





133 H

HARD METAL TIP FLAT SCRAPER

- ▶ Soldered hard metal tip
- ▶ Wooden handle







Code	No.	mm:↔	mm:↔				
4523000	133 H	30	5	250	365	350	3

133 D

GASKET SCRAPER

- ▶ Made from special steel
- ▶ With wooden handle
- ▶ Flanged blade





Code	No.				
1395262	133 D-150	150	270	120	10

133 K

GASKET SCRAPER

- ▶ With plastic handle







Code	No.	inch:↔	mm:↔	mm:↔		
6535190	133 K	10	240	22.5	154	5

134

THREE-EDGED FLAT GROUND SCRAPER

- ▶ Acc. to DIN 8350 Form B
- ▶ Made from special steel
- ▶ Working ends polished
- ▶ With wooden handle
- ▶ Flanged blade







Code	No.				
8781620	134-100	100	200	72	10
8781700	134-125	125	225	81	10
8781890	134-150	150	270	139	10
8781970	134-175	175	295	118	10
8782000	134-200	200	315	168	10
8782190	134-250	250	365	190	10
8782270	134-300	300	415	220	10

134 K

THREE-SQUARE SCRAPER

- ▶ With ground edges
- ▶ Shaft PVC coated
- ▶ Black plastic handle



Code	No.	mm:↔				
4646860	134 K	6	80	170	60	5



STRIKING TOOLS ++

WHAT IS SO SPECIAL ABOUT GEDORE STRIKING TOOLS?

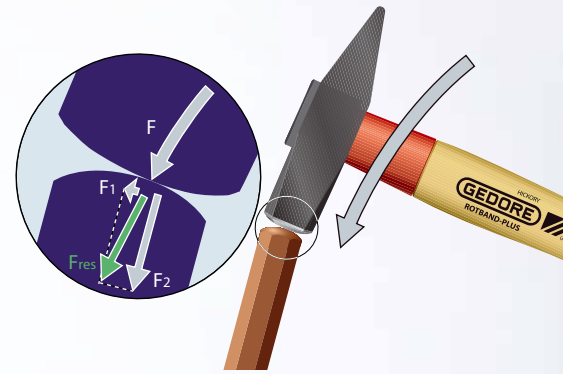

- ▶ The striking thing about GEDORE striking tools is the 45CrMoV7 material used - one which has a 30% higher strength (under the same hardness) than the usual DIN 59CrV4 material. This very much distinguishes GEDORE striking tools from the products of its competitors.
- ▶ This is very true indeed for nail lifters.
- ▶ The material (45CrMoV7) used by GEDORE is a pure air-hardening steel which hardens at a temperature of about 850°C in still air. This material features both a high level of stability and enormous toughness. Tools cannot break even under the hardest of working conditions.
- ▶ GEDORE striking tools are hot forged.

- ▶ Pin punches, drift punches and centre punches are also hot forged and thus provided with a very homogeneous structure.
- ▶ GEDORE pin punches always have a minus tolerance. This rules out any jamming in the drill hole.
- ▶ All tools are fully hardened over their entire length. Tools cannot break even under the hardest of working conditions.
- ▶ The hammer heads of our tools are electro-inductively and hence homogeneously tempered. In this way, maximum stability is achieved and splintering avoided.
- ▶ The head shape of the GEDORE striking tools is optimally adapted to the radius of the hammer face.



SAFETY NOTES FOR STRIKING TOOLS



CHISELS

- ▶ Wear safety glasses and safety gloves!
- ▶ Before starting work, check that the chisel blade is sharp and the striking end is burr-free! The blades must be properly wet-sharpened!
- ▶ Select the appropriate type and size of chisel for the work to be carried out!
- ▶ Hold the chisel with a firm grip!
- ▶ When working, keep your eyes on the chisel tip!
- ▶ Wherever possible, use a chisel with hand guard.
- ▶ Never use chisels on workpieces harder than 40 HRC!
- ▶ Set safety guards in place to prevent splinters and chips posing a hazard for other people!

CENTRE PUNCHES, DRIFTS AND MORTISE CHISELS

- ▶ These tools are subject to the same safety rules as chisels.



➔ 922 • 923

487



CHISELS

108 UNI

PROTECTIVE HAND GUARD

- ▶ Made from PVC
- ▶ Improved protective plate offers highest safety for the hand against impacts
- ▶ Ergonomic design
- ▶ Avoids injuries of the hand
- ▶ No rolling away (elliptical-shaped)
- ▶ Jarring blows do not move into the hand
- ▶ No fatigue of the hand - optimum hold
- ▶ All chisels from 250 mm length can be supplied with universal protective hand guard (HS)
- ▶ DBGM (German utility patent)



product design award

2008

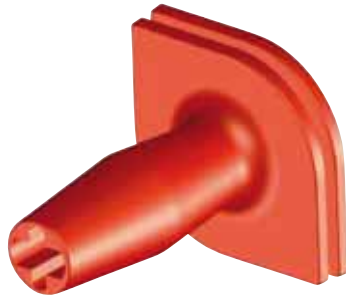
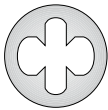

Code	No.	oval	octagonal	↕	☰
8658500	108 UNI	20 x 12 23 x 13 26 x 13 26 x 7	14 16 18 20	182	1

95

FLAT COLD CHISEL flat oval

- ▶ Acc. to DIN 6453
- ▶ Chrome-molybdenum-vanadium air hardening steel 45CrMoV7
- ▶ Carefully hardened and tempered along the full length
- ▶ Striking heads inductively tempered
- ▶ Working edge polished and clear varnished
- ▶ * not standardised

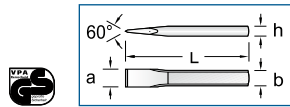

Code	No.	*	L	a	b	h	↕	☰
8698560	95-100		100	15	14	9	75	10
8698640	95-125		125	15	14	9	100	10
8698720	95-150		150	18	17	11	190	10
8698800	95-175		175	21	20	12	280	10
8698990	95-200		200	24	23	13	390	10
8699610	95-225	*	225	24	23	13	460	10
8699020	95-253		250	25	23	13	500	10
8699100	95-250	*	250	28	26	13	570	10
8699290	95-303		300	26	23	13	604	10
8699370	95-300	*	300	30	26	13	710	10
8699450	95-400	*	400	30	26	13	950	10
8699530	95-500	*	500	30	26	13	1160	1

95 HS

FLAT COLD CHISEL flat oval

- ▶ Acc. to DIN 6453
- ▶ With protective hand guard 108 UNI
- ▶ Chrome-molybdenum-vanadium air hardening steel 45CrMoV7
- ▶ Carefully hardened and tempered along the full length
- ▶ Striking heads inductively tempered
- ▶ Working edge polished and clear varnished
- ▶ * not standardised

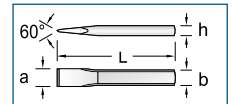
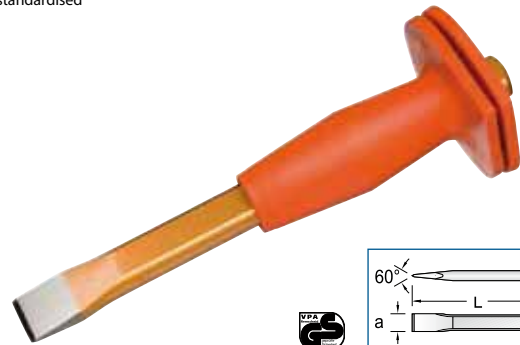

Code	No.	*	L	a	b	h	↕	☰
8699880	95 HS-253		250	25	23	13	630	1
8699960	95 HS-250	*	250	28	26	13	700	1
8700560	95 HS-303		300	25	23	13	730	1
8700640	95 HS-300	*	300	30	26	13	822	1
8700720	95 HS-400	*	400	30	26	13	1070	1
8700800	95 HS-500	*	500	30	26	13	1290	1

95 N

FLAT COLD CHISEL flat oval, extra slim pattern

- ▶ Chrome-molybdenum-vanadium air hardening steel 45CrMoV7
- ▶ Carefully hardened and tempered along the full length
- ▶ Striking heads inductively tempered
- ▶ Working edge polished and clear varnished

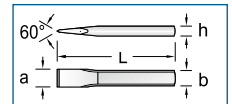

Code	No.	L	a	b	h	↕	☰
8700050	95 N-200	200	26	23	13	370	10
8700130	95 N-250	250	30	26	13	530	10
8700210	95 N-300	300	30	26	13	650	10
8700480	95 N-400	400	30	26	13	890	10

95 NHS

FLAT COLD CHISEL flat oval, extra slim pattern

- ▶ With protective hand guard 108 UNI
- ▶ Chrome-molybdenum-vanadium air hardening steel 45CrMoV7
- ▶ Carefully hardened and tempered along the full length
- ▶ Striking heads inductively tempered
- ▶ Working edge polished and clear varnished

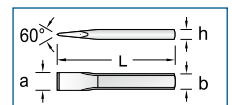

Code	No.	L	a	b	h	↕	☰
8701530	95 NHS-250	250	30	26	13	660	1
8701610	95 NHS-300	300	30	26	13	790	1
8701880	95 NHS-400	400	30	26	13	1010	1

920 • 921 • 922



487



97

FLAT COLD CHISEL octagonal

- ▶ Chrome-molybdenum-vanadium air hardening steel 45CrMoV7
- ▶ Carefully hardened and tempered along the full length
- ▶ Striking heads inductively tempered
- ▶ Working edge polished and clear varnished

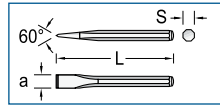

Code	No.	L	a	s	⚡	📦
8703820	97-125	125	12	10	69	10
8703900	97-150	150	16	12	130	10
8704040	97-175	175	20	16	270	10
8704120	97-200	200	22	18	380	10
2004666	97-250	250	24	20	406	10

104

SPLITTING CHISEL flat

- ▶ Chrome-molybdenum-vanadium air hardening steel 45CrMoV7
- ▶ Forged
- ▶ Carefully hardened and tempered along the full length
- ▶ Striking heads inductively tempered
- ▶ Working edge polished and clear varnished
- ▶ 104 HS with protective hand guard 108 UNI
- ▶ 104 P with plastic grip

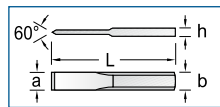
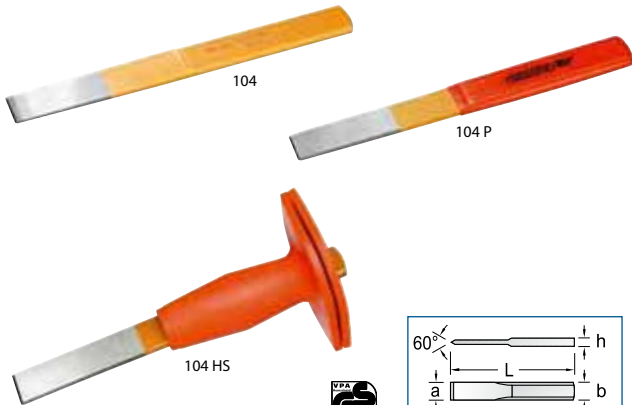

Code	No.	L	a	b	h	⚡	📦
8723850	104	240	26	26	7	260	1
8724230	104 P	240	26	26	7	290	1
8723930	104 HS	240	26	26	7	400	1

2104

SPLITTING CHISEL extra flat

- ▶ Chrome-vanadium steel
- ▶ Carefully hardened and tempered along the full length
- ▶ Striking heads inductively tempered
- ▶ Working edges polished and clear varnished

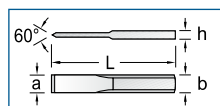
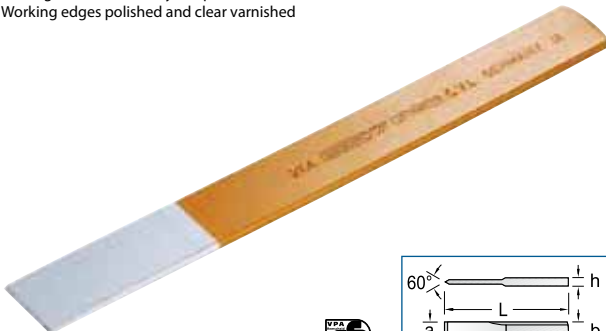

Code	No.	L	a	b	h	⚡	📦
8911420	2104	240	26	26	4	198	10

105

SPLITTING CHISEL octagonal

- ▶ Chrome-molybdenum-vanadium air hardening steel 45CrMoV7
- ▶ Carefully hardened and tempered along the full length
- ▶ Striking heads inductively tempered
- ▶ Working edge polished and clear varnished
- ▶ 105 HS with protective hand guard 108 UNI

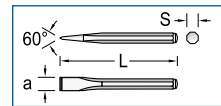

Code	No.	L	a	s	⚡	📦
8724660	105-240	240	30	18	380	10
8856730	105-300	300	30	18	470	10
8724740	105 HS-240	240	30	18	545	1
8875280	105 HS-300	300	30	18	610	1

103

BRICK CUTTING CHISEL flat oval

- ▶ With broad blade to chisel joints into walls, plaster, tiles, etc.
- ▶ Chrome-molybdenum-vanadium air hardening steel 45CrMoV7
- ▶ Carefully hardened and tempered along the full length
- ▶ Striking heads inductively tempered
- ▶ 103 HS with protective hand guard 108 UNI

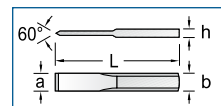
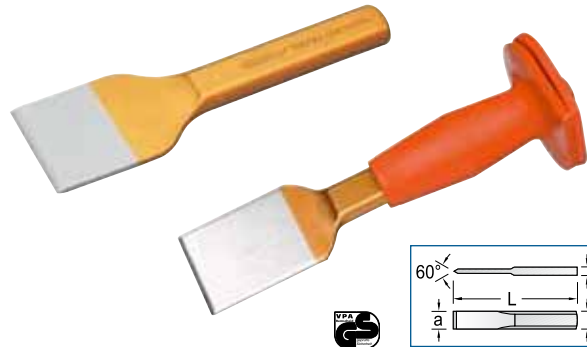

Code	No.	L	a	b	h	⚡	📦
8723420	103-50	250	50	26	13	532	5
8723500	103-60	250	60	26	13	557	5
8723690	103-80	250	80	26	13	558	5
8746710	103 HS-50	250	50	26	13	650	1
8912310	103 HS-60	250	60	26	13	670	1
8721800	103 HS-80	250	80	26	13	675	1





109

BRICKLAYER'S CHISEL flat oval

- ▲ Acc. to DIN 7254 Form A
- ▲ Chrome-molybdenum-vanadium air hardening steel 45CrMoV7
- ▲ Carefully hardened and tempered along the full length
- ▲ Striking heads inductively tempered
- ▲ Working edge polished and clear varnished
- ▲ * not standardised

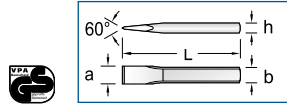
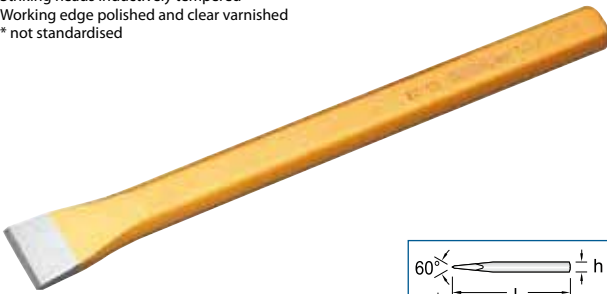

Code	No.	*	L	a	b	h	↕	☒
8728650	109-200		200	26	20	12	320	10
8728730	109-250		250	26	20	12	400	10
8728810	109-300		300	29	23	13	610	10
8729030	109-350		350	29	23	13	710	10
8729110	109-400		400	29	23	13	830	10
8729380	109-500		500	32	26	13	1180	1
8729460	109-600	*	600	32	26	13	1410	1
8729540	109-800	*	800	32	26	13	1880	1
8861140	109-1000	*	1000	32	26	13	2360	1

109 HS

BRICKLAYER'S CHISEL flat oval

- ▲ Acc. to DIN 7254 Form A
- ▲ With protective hand guard 108 UNI
- ▲ Chrome-molybdenum-vanadium air hardening steel 45CrMoV7
- ▲ Carefully hardened and tempered along the full length
- ▲ Striking heads inductively tempered
- ▲ Working edge polished and clear varnished
- ▲ * not standardised

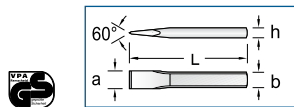
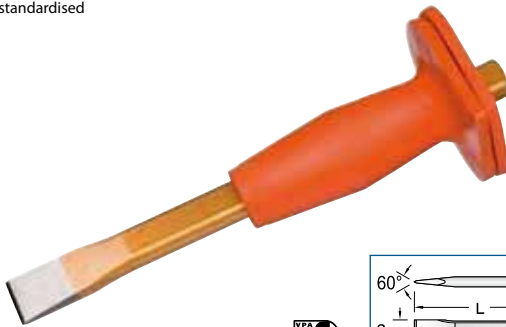

Code	No.	*	L	a	b	h	↕	☒
8729620	109 HS-250		250	26	20	12	530	1
8729700	109 HS-300		300	29	23	13	730	1
8730550	109 HS-350		350	29	23	13	830	1
8730630	109 HS-400		400	29	23	13	1068	1
8730710	109 HS-500		500	32	26	13	1230	1
8730980	109 HS-600	*	600	32	26	13	1520	1
8732410	109 HS-800	*	800	32	26	13	2010	1
8911930	109 HS-1000	*	1000	32	26	13	2710	1

110

BRICKLAYER'S CHISEL octagonal

- ▲ Acc. to DIN 7254 Form B
- ▲ Chrome-molybdenum-vanadium air hardening steel 45CrMoV7
- ▲ Carefully hardened and tempered along the full length
- ▲ Striking heads inductively tempered
- ▲ Working edge polished and clear varnished
- ▲ * not standardised

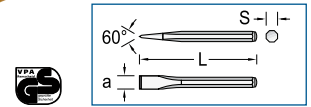

Code	No.	*	L	a	s	↕	☒
8731280	110-216		200	23	16	300	10
8731440	110-256		250	23	16	390	10
8731600	110-316	*	300	23	16	460	10
8731790	110-318		300	26	18	600	10
8731870	110-358		350	26	18	700	10
8731950	110-418	*	400	26	18	810	10
8732090	110-420		400	30	20	990	10
8732170	110-520		500	30	20	1240	1
8732250	110-622	*	600	32	22	1810	1

110 HS

BRICKLAYER'S CHISEL octagonal

- ▲ Acc. to DIN 7254 Form B
- ▲ With protective hand guard 108 UNI
- ▲ Chrome-molybdenum-vanadium air hardening steel 45CrMoV7
- ▲ Carefully hardened and tempered along the full length
- ▲ Striking heads inductively tempered
- ▲ Working edge polished and clear varnished
- ▲ * not standardised

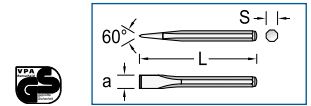

Code	No.	*	L	a	s	↕	☒
8732680	110 HS-256		250	23	16	510	1
8732840	110 HS-316	*	300	23	16	600	1
8733140	110 HS-318		300	26	18	720	1
8732920	110 HS-358		350	26	18	816	1
8733060	110 HS-418	*	400	26	18	930	1
8733220	110 HS-420		400	30	20	1110	1
8733300	110 HS-520		500	30	20	1380	1

111

POINT CHISEL octagonal

- ▲ Acc. to DIN 7256
- ▲ Chrome-molybdenum-vanadium air hardening steel 45CrMoV7
- ▲ Carefully hardened and tempered along the full length
- ▲ Striking heads inductively tempered
- ▲ Working edge polished and clear varnished, free of burrs

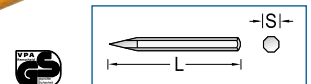

Code	No.	L	s	↕	☒
8741080	111-216	200	16	290	10
8741240	111-256	250	16	370	10
8741400	111-316	300	16	444	10
8741590	111-318	300	18	576	10
8741670	111-358	350	18	670	10
8741750	111-418	400	18	775	10
8741830	111-420	400	20	955	10
8741910	111-520	500	20	1215	1
8742050	111-622	600	22	1780	1

620 H



432



111 HS

POINT CHISEL octagonal

- Acc. to DIN 7256
- With protective hand guard 108 UNI
- Chrome-molybdenum-vanadium air hardening steel 45CrMoV7
- Carefully hardened and tempered along the full length
- Striking heads inductively tempered
- Working edge polished and clear varnished

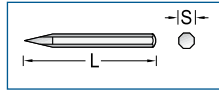

Code	No.	L	s	↕	☒
8742210	111 HS-256	250	16	500	1
8742560	111 HS-316	300	16	570	1
8742800	111 HS-318	300	18	695	1
8742640	111 HS-358	350	18	800	1
8742720	111 HS-418	400	18	910	1
8742990	111 HS-420	400	20	1130	1
8743020	111 HS-520	500	20	1335	1

112

ELECTRICIANS' CHISEL square

- Chrome-vanadium steel
- Carefully hardened and tempered along the full length
- Striking heads inductively tempered
- Working edge polished and clear varnished

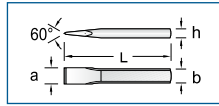

Code	No.	L	a	s	↕	☒
8744500	112-2006	200	6	6	54	10
8744690	112-2008	200	8	6	54	10
8744770	112-2100	200	10	7	73	10
8744930	112-2508	250	8	6	68	10
8745070	112-2510	250	10	7	91	10
8745150	112-2512	250	12	8	119	10
8745230	112-2515	250	15	10	188	10
8745310	112-3000	300	15	10	227	10

112 A

ELECTRICIANS' CHISEL octagonal

- Chrome-molybdenum-vanadium air hardening steel 45CrMoV7
- Carefully hardened and tempered along the full length
- Striking heads inductively tempered
- Working edge polished and clear varnished

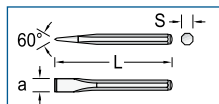

Code	No.	L	a	s	↕	☒
8745820	112 A-200	200	10	10	118	10
8745900	112 A-250	250	12	10	152	10
8746040	112 A-300	300	15	12	264	10

112 S

ELECTRICIANS' SPLITTING CHISEL

- Chrome-molybdenum-vanadium air hardening steel 45CrMoV7
- Carefully hardened and tempered along the full length
- Striking heads inductively tempered
- Working edge polished and clear varnished



Code	No.	L	↕	☒
8746550	112 S	200	228	10

96

CROSS-CUT CHISEL flat oval

- Acc. to DIN 6451
- Chrome-molybdenum-vanadium air hardening steel 45CrMoV7
- Carefully hardened and tempered along the full length
- Striking heads inductively tempered
- Working edge polished and clear varnished
- 96 HS with protective hand guard 108 UNI

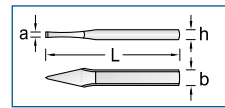

Code	No.	L	a	b	h	↕	☒
8702180	96-125	125	5	14	9	98	10
8702260	96-150	150	6	17	11	170	10
8702340	96-175	175	7	17	11	210	10
8702420	96-200	200	8	20	12	290	10
8702500	96-250	250	9	23	13	530	10
8702690	96-300	300	10	23	13	610	10
8702770	96 HS-250	250	9	23	13	600	1
8702850	96 HS-300	300	10	23	13	700	1

98

CROSS-CUT CHISEL octagonal

- Chrome-molybdenum-vanadium air hardening steel 45CrMoV7
- Carefully hardened and tempered along the full length
- Striking heads inductively tempered
- Working edge polished and clear varnished

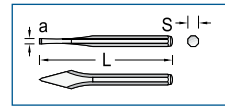

Code	No.	L	a	s	↕	☒
8704630	98-125	125	5	10	66	10
8704710	98-150	150	7	12	140	10
8704980	98-175	175	9	16	260	10
8705010	98-200	200	10	18	350	10



202

TILE CHISEL flat

- ▶ Chrome-vanadium steel 59CrV4
- ▶ Carefully hardened and tempered along the full length
- ▶ Striking heads inductively tempered
- ▶ Working edge polished and clear varnished

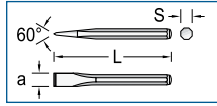

Code	No.	L	a	s		
8879270	202-80	80	6	6	21	10
8879350	202-90	90	8	6	24	10
8879430	202-100	100	10	7	33	10

203

TILE CHISEL pointed

- ▶ Chrome-vanadium steel 59CrV4
- ▶ Driving point polished and clear varnished

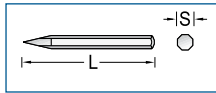

Code	No.	L	s		
8880010	203-80	80	6	21	10
8880280	203-100	100	7	32	10

207

CARBIDE TILE CHISEL



Code	No.	L mm	mm		
8881090	207-85	90	8	50	10

128

PARING CHISEL octagonal

- ▶ Chrome-molybdenum-vanadium air hardening steel 45CrMoV7
- ▶ Carefully hardened and tempered along the full length
- ▶ Striking heads inductively tempered
- ▶ Working edge polished and clear varnished

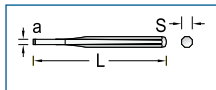

Code	No.	L	a	s		
8775650	128-2	120	2	10	70	10
8775730	128-3	120	3	10	67	10

129

GROOVING CHISEL octagonal

- ▶ Acc. to DIN 6455
- ▶ Chrome-molybdenum-vanadium air hardening steel 45CrMoV7
- ▶ Carefully hardened and tempered along the full length
- ▶ Striking heads inductively tempered
- ▶ Working edge polished and clear varnished

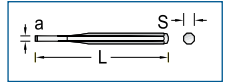

Code	No.	L	a	s		
8776380	129-2	150	2	10	68	10
8776460	129-3	150	3	10	70	10
8776540	129-4	150	4	10	74	10
8776620	129-5	150	5	10	80	10
8776700	129-6	150	6	10	84	10

DRIFT / CENTRE / PIN PUNCHES

99

DRIFT PUNCH

- ▶ Acc. to DIN 6458
- ▶ Chrome-molybdenum-vanadium air hardening steel 45CrMoV7
- ▶ Carefully hardened and tempered along the full length
- ▶ Striking heads inductively tempered
- ▶ Working edge polished and clear varnished
- ▶ Special types or sizes on request
- ▶ * not standardised

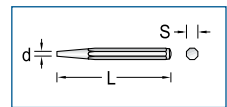

Code	No.	*	L	s	d		
8708700	99 10-1		120	10	1	60	10
8708970	99 10-2		120	10	2	61	10
8709190	99 10-3		120	10	3	63	10
8709350	99 10-4		120	10	4	65	10
8709510	99 10-5		120	10	5	63	10
8709780	99 10-6		120	10	6	67	10
8710520	99 12-1		120	12	1	84	10
8710790	99 12-2		120	12	2	85	10
8710950	99 12-3		120	12	3	88	10
8711170	99 12-4		120	12	4	86	10
8711330	99 12-5		120	12	5	91	10
8711410	99 12-6		120	12	6	94	10
8711680	99 12-7		120	12	7	96	10
8711760	99 12-8		120	12	8	99	10
8711840	99 12-9	*	120	12	9	105	10
8711920	99 12-10	*	120	12	10	103	10
8713890	99 15-9		150	12	9	132	10
8713970	99 15-10		150	12	10	136	10
8714430	99 15-12	*	150	14	12	181	10
8714940	99 15-14	*	150	16	14	238	10



100

CENTRE PUNCH

- Acc. to DIN 7250
- Chrome-molybdenum-vanadium air hardening steel 45CrMoV7
- Carefully hardened and tempered along the full length
- Striking heads inductively tempered
- Working edge polished and clear varnished
- * not standardised

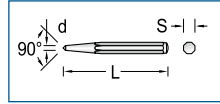

Code	No.	*	L	s	d	±	⊞
8721050	100-10		120	10	4	63	10
8721130	100-12		120	12	5	91	10
8721210	100-15		150	12	5	119	10
8721480	100-16	*	150	16	8	216	10



100 A

CENTRE PUNCH with carbide tip

- Chrome-molybdenum-vanadium air hardening steel 45CrMoV7

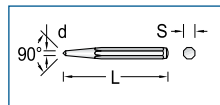

Code	No.	L	s	d	±	⊞
8721720	100 A-10	120	10	4	63	10
1568396	100 A-12	130	12	4	89	10

101

AUTOMATIC CENTRE PUNCH with tip

- For one hand operation
- With spring mechanism
- Impact power can be set by a screw thread
- With hand protection for comfortable and safe working
- Spare tip E 101



Code	No.	L	s	d	±	⊞
8722880	101	145	16	4	145	1
8870800	E 101			4	10	1

119

PIN PUNCH

- Acc. to DIN 6450
- Chrome-molybdenum-vanadium air hardening steel 45CrMoV7
- Carefully hardened and tempered along the full length
- Striking heads inductively tempered
- Working edge polished and clear varnished
- No. 119-175 with pilot
- Special types or sizes on request
- * not standardised

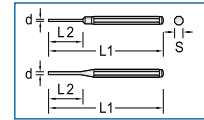
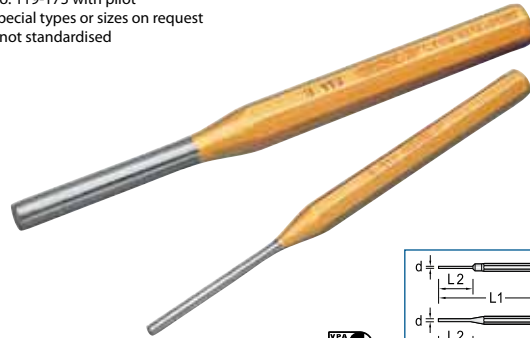

Code	No.	*	L ₁	L ₂	d	s	±	⊞
2004658	119-1,5	*	150	30	1.5	8	61	10
8758640	119-2		150	30	2.0	10	70	10
8758720	119-2,5	*	150	30	2.5	10	69	10
8758800	119-3		150	40	3.0	10	71	10
8758990	119-3,5	*	150	40	3.5	10	72	10
8759020	119-4		150	50	4.0	10	61	10
8759290	119-5		150	50	5.0	10	68	10
8759370	119-6		150	50	6.0	10	73	10
8759450	119-7	*	150	50	7.0	12	103	10
8759530	119-8		150	50	8.0	12	109	10
8759610	119-9	*	150	50	9.0	12	115	10
8759880	119-10	*	150	50	10.0	12	123	10
8759960	119-12	*	150	50	12.0	14	170	10
8761350	119-175		175	85	6.0	10	70	10



114

PIN PUNCH with guide sleeve

- Driving point made from material 115CrV3, hardened 55-59 HRC
- Shank knurled
- Fine grinded and polished



Code	No.	L	d	±	⊞
8755460	114-09	80	0.9	6	10
8755540	114-14	85	1.4	12	10
8755620	114-18	88	1.8	12	10
8755700	114-24	92	2.4	18	10
8755890	114-28	96	2.8	20	10
8755970	114-34	96	3.4	26	10
8756000	114-39	100	3.9	26	10
8756190	114-59	100	5.9	32	10

115

PIN PUNCH SET 8 pieces

- In metal case with lid
- With guide sleeve
- Driving point made from material 115CrV3, hardened 55-59 HRC
- Shank knurled
- Fine grinded and polished



Code	No.	Contents	±	⊞
8756780	115	114-09 -14 -18 -24 -28 -34 -39 -59	350	1



SETS

116 A - 116 L - 119 L

PIN PUNCH SET 6 pieces

- ▶ Chrome-molybdenum-vanadium air hardening steel 45CrMoV7
- ▶ Carefully hardened and tempered along the full length
- ▶ Striking heads inductively tempered
- ▶ Working edge polished and clear varnished
- ▶ 116 L / 119 L = long pattern



116 D



116



116 A



116 L



119 L



Code	No.	Execution	Contents	Weight	Units
8757240	116	wooden stand	119 -3 -4 -5 -6 -7 -8	714	1
8758050	116 D	metal case with lid	119 -3 -4 -5 -6 -7 -8	820	1
8757670	116 A	PVC holder	119 -3 -4 -5 -6 -7 -8	530	1
8839990	116 L	PVC holder	119 -2 -3 -5 -175 -175-4 -175-6	475	1
8866290	119 L	PVC holder	119 -175-4 175-5 175-6 175-7 175-8 175-10	580	1

113 - 113 D

DRIFT PUNCH SET 6 pieces

- ▶ Chrome-molybdenum-vanadium air hardening steel 45CrMoV7
- ▶ Carefully hardened and tempered along the full length
- ▶ Striking heads inductively tempered
- ▶ Working edge polished and clear varnished



Code	No.	Execution	Contents	Weight	Units
8753680	113	PVC holder	99 10-1 2 3 99 12-4 5 100 -10	460	1
8754060	113 D	metal case with lid	99 10-1 2 3 99 12-4 5 100 -10	755	1

106 - 106 D

CHISEL AND PUNCH SET 6 pieces

- ▶ Chrome-molybdenum-vanadium air hardening steel 45CrMoV7
- ▶ Carefully hardened and tempered along the full length
- ▶ Striking heads inductively tempered
- ▶ Working edge polished and clear varnished



Code	No.	Execution	Contents	Weight	Units
8725200	106	PVC holder	97 -125 150 98 -125 99 12-3 100 -10 119 -4	525	1
8725710	106 D	Metal case with lid	97 -125 150 98 -125 99 12-3 100 -10 119 -4	805	1

102

CHISEL AND PUNCH SET 6 pieces

- ▶ Chrome-molybdenum-vanadium air hardening steel 45CrMoV7
- ▶ Carefully hardened and tempered along the full length
- ▶ Striking heads inductively tempered
- ▶ Working edge polished and clear varnished
- ▶ In wooden stand



Code	No.	Contents	Weight	Units
8723340	102	97 -125 150 98 -125 99 12-3 100 -10 119 -4	695	1

107

CHISEL AND PUNCH SET 12 pieces

- ▶ Chrome-molybdenum-vanadium air hardening steel 45CrMoV7
- ▶ Carefully hardened and tempered along the full length
- ▶ Striking heads inductively tempered
- ▶ Working edge polished and clear varnished
- ▶ In wooden stand

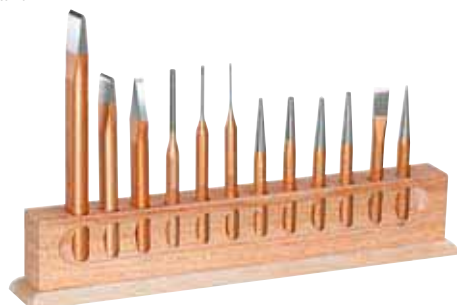

Code	No.	Contents	Weight	Units
8726440	107	95 -150 200 96 -150 97 -125 99 10-2 3 4 5 100 -10 119 -2 3 5	2075	1

**MERCHANDISER****1130****MERCHANDISER FOR STRIKING TOOLS 130 pieces**

- Tools made from chrome-molybdenum-vanadium air hardening steel 45CrMoV7
- Merchandiser made from sheet metal



Code	No.	Contents		
8901970	1130	10 pieces each 119-2 3 4 5 6 7 8 99 10-2 3 4 5 100-10 12	13.3	1

1190**CHISEL MERCHANDISER 90 pieces**

- Chisels made from chrome-molybdenum-vanadium air hardening steel 45CrMoV7
- Working edge polished and clear varnished
- Merchandiser made from sheet metal, blue-grey varnished



Code	No.	Contents		
8913040	1190	10 pieces each 95-200 -250 103-60 104 109-300 110-316 111-316 112 A-250 112-2508	40.2	1

1132**CHISEL MERCHANDISER 132 pieces**

- Merchandiser for counter and wall display
- Assortment of best selling articles
- Made from acrylic sheeting, colour printed
- Chrome-molybdenum-vanadium air hardening steel 45CrMoV7
- Working edge polished and clear varnished



Code	No.	Contents		
8779800	1132	6 pieces each 95-150 200 250 300 96-150 200 99 10-2 3 4 5 99 12-6 8 100-10 12 119-2 3 4 5 6 7 8 104	24.0	1

3200**CHISEL MERCHANDISER 320 pieces**

- Particularly suitable on a display wall
- Assortment of best selling articles
- Chisels made from chrome-molybdenum-vanadium air hardening steel 45CrMoV7
- Working edge polished and clear varnished
- Merchandiser made from sheet metal



Code	No.	Contents		
8604840	3200	10 pieces each 95-150 175 200 250 96-175 99 10-2 3 4 100-12 15 104 109-250 300 350 400 110-256 316 418 111-256 316 418 112-2006 2508 2512 112 A-300 119-2 3 4 5 202-100 203-100 5 pieces each 103-60 80	99.0	1



VARIOUS

206

TILER'S SETTING TOOL

- ▶ Chrome-vanadium steel 59CrV4
- ▶ Carefully hardened and tempered along the full length
- ▶ Striking heads inductively tempered
- ▶ Working edge polished and clear varnished



Code	No.	l=mm=	mm		
8880600	206-150	150	8	70	10

90 HS

RIVET SETTER octagonal

- ▶ Chrome-molybdenum-vanadium air hardening steel 45CrMoV7, zinc-plated
- ▶ Carefully hardened and tempered along the full length
- ▶ Striking heads inductively tempered
- ▶ With black protective hand guard for safe comfortable working
- ▶ DBGM (= German Utility Patent)



Code	No.	L	s		
8885830	90 HS-4	160	18	488	1
8886130	90 HS-6	160	18	488	1

2200 - 2201

LETTER AND NUMBER PUNCHES

- ▶ To label finished parts such as signs, tools, etc.
- ▶ Made from hardened steel with hardened handle and tempered striking head
- ▶ In blue plastic box
- ▶ No. 2200 = 9 numbers, 6 mm printing height
- ▶ No. 2201 = 27 letters, 6 mm printing height

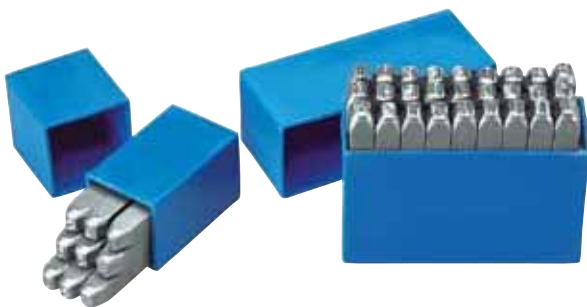

Code	No.	l=mm=	mm		
8605140	2200-6	70	9	415	1
8605220	2201-6	70	9	1240	1

208

CARBIDE SCRIBER hexagonal



Code	No.	l=mm=	mm		
8881680	208-150	150	6	40	10

126

RIVETTING SETTER

- ▶ Acc. to DIN 6434
- ▶ Chrome-molybdenum-vanadium air hardening steel 45CrMoV7
- ▶ Working edge polished and clear varnished



		for rivet shaft							
Code	No.	Ø mm	internal Ø	L	s				
8774090	126-2	2	2.5	100	10	63	10		
8774170	126-3	3	3.5	100	10	61	10		
8774250	126-4	4	4.5	100	12	81	10		
8774330	126-5	5	6.0	110	12	132	10		
8774410	126-6	6	7.0	110	14	130	10		
8774680	126-8	8	9.0	120	16	185	10		

127

RIVETTING SNAP DIE

- ▶ Acc. to DIN 6435
- ▶ Chrome-molybdenum-vanadium air hardening steel 45CrMoV7
- ▶ Working edge polished and clear varnished



		for rivet shaft							
Code	No.	Ø mm	internal Ø	L	s				
8775060	127-2	2	3.5	100	10	62	10		
8775140	127-3	3	5.2	100	10	63	10		
8775220	127-4	4	7.0	100	12	90	10		
8775300	127-5	5	8.8	110	14	133	10		
8775490	127-6	6	10.5	110	16	173	10		
8775570	127-8	8	14.0	120	20	326	10		

125 B

SET OF RIVETTING SETTERS AND SNAP DIES 6 pieces

- ▶ Chrome-molybdenum-vanadium air hardening steel 45CrMoV7
- ▶ Hardened in accordance with the technical specifications for striking tools to DIN 7255
- ▶ Working edge polished and clear varnished
- ▶ In PVC holder



Code	No.	Contents		
8773600	125 B	126-2 3 4 127-2 3 4	470	1



BENDING BARS / PRYBARS

135

SETTING PUNCH

- Chrome-vanadium steel 59CrV4
- Hardened and tempered along the full length
- Special sizes available on request

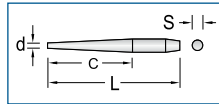

Code	No.	L	c	d	s	mm	mm	mm
8782350	135-5	180	110	5	12	110	1	
8782430	135-6	200	120	6	13	150	1	
8782510	135-8	200	130	8	16	225	1	
8782780	135-9	200	130	9	20	340	1	
8782860	135-10	230	140	10	22	490	1	
8782940	135-11	250	155	11	25	620	1	
8783080	135-12	280	170	12	27	890	1	
8783160	135-14	315	190	14	30	1250	1	
8783240	135-15	340	200	15	32	1570	1	
8783320	135-16	380	220	16	36	2190	1	

136

TAPER PUNCH octagonal

- Chrome-molybdenum-vanadium air hardening steel 45CrMoV7
- Carefully hardened and tempered along the full length

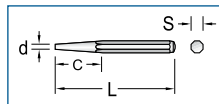

Code	No.	L	c	d	s	mm	mm	mm
8783400	136-500	500	170	5	20	1050	1	

137

BENDING BAR

- Chrome-molybdenum-vanadium air hardening steel 45CrMoV7
- Carefully hardened and tempered along the full length

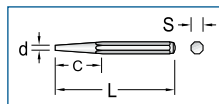
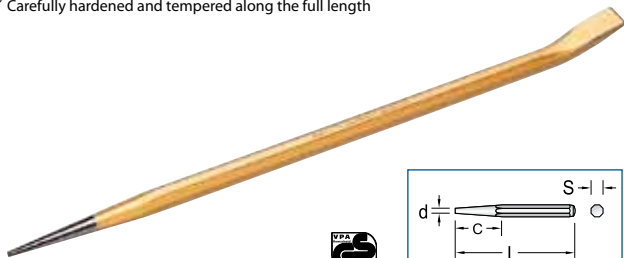

Code	No.	L	c	d	s	mm	mm	mm
8783590	137-600	600	120	5	20	1305	1	

138

BENDING TOOL

- Chrome-vanadium air hardening steel 59CrV4, nickel-plated
- Carefully hardened and tempered along the full length



Code	No.	mm	mm	mm
1396609	138-400	400	645	1

139

PRYBAR

- Chrome-vanadium steel 31CrV3, nickel-plated



Code	No.	mm	mm	mm
1396595	139-400	400	480	1

140

UNIVERSAL PRYBAR

- Made from special steel, hardened
- Cutting edge polished
- With three nail pullers



Code	No.	mm	mm	mm
8894310	140-380	380	650	1

141

PRYBAR

- Chrome-molybdenum-vanadium air hardening steel 45CrMoV7, chromated
- Hardened along the full length
- With plastic handle
- Very robust and resilient



Code	No.	mm	mm	mm	mm	mm
1471945	141-300	300	11	10	230	1
1471937	141-390	390	13	12	390	1
1471929	141-600	600	20	14	785	1

S 141-3

PRYBAR SET 3 pieces

- Chrome-molybdenum-vanadium air hardening steel 45CrMoV7, chromated
- Hardened along the full length
- With plastic handle
- Very robust and resilient
- Packed in cardboard box



Code	No.	Contents	mm	mm
1525476	S 141-3	141-300 390 600	1474	1

142

ALUMINIUM PRYBAR

- Forged of high-class aluminium
- Extremely light and very robust
- For universal use - with pry and tip
- Sensitive parts can be levered gently



Code	No.	mm	mm	mm
1859188	142-430	430	405	1





NAIL LIFTER / CROWBARS

120

WRECKING BAR octagonal

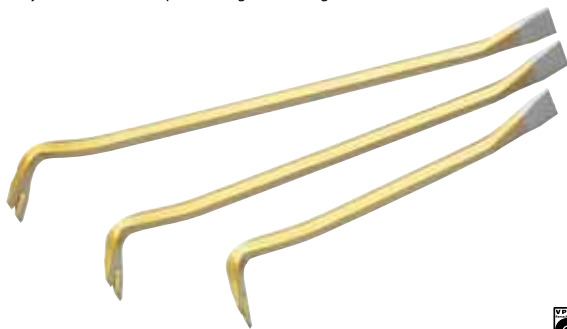
- ✔ Chrome-molybdenum-vanadium air hardening steel 45CrMoV7
- ✔ Carefully hardened and tempered along the full length





Code	No.	l-mm	octagonal		
8769330	120-350	350	18	840	1
8769410	120-500	500	18	1150	1
8769680	120-600	600	18	1355	1
8769760	120-700	700	18	1550	1
8769840	120-800	800	18	1770	1
8769920	120-1000	1000	18	2175	1

121

NAIL LIFTER octagonal

- ✔ For lifting very long nails
- ✔ No underlay aids are necessary because of the ratchet function
- ✔ Chrome-molybdenum-vanadium air hardening steel 45CrMoV7
- ✔ Carefully hardened and tempered along the full length





Code	No.	l-mm	octagonal		
8577930	121-600	600	18	1665	1

122

CROWBAR

- ✔ With straight cutting edge and point





Code	No.	l-mm	Ø		
8770500	122-1000	1000	30	5.3	1
8770690	122-1250	1250	30	6.9	1
8770770	122-1500	1500	30	8.3	1
8852580	122-2000	2000	30	11.0	1

123

CROWBAR

- ✔ With curved cutting edge and point





Code	No.	l-mm	Ø		
8771230	123-1000	1000	30	5.3	1
8771310	123-1250	1250	30	6.9	1
8771580	123-1500	1500	30	8.3	1
8852660	123-2000	2000	30	11.0	1

124

CROWBAR

- ✔ With claw and point





Code	No.	l-mm	Ø		
8772040	124-1000	1000	30	5.2	1
8772120	124-1250	1250	30	6.9	1
8772200	124-1500	1500	30	8.3	1
8852740	124-2000	2000	30	11.0	1

150

CROWBAR

- ✔ Heavy-duty model, edged
- ✔ With curved cutting edge and point





Code	No.	l-mm		
8823990	150-1000	1000	4.6	1
8824020	150-1250	1250	6.7	1
8824100	150-1500	1500	8.1	1
8824450	150-2000	2000	13.6	1

151

CROWBAR

- ✔ Heavy-duty model
- ✔ With round head and cutting edge





Code	No.	l-mm	Ø		
8824530	151-1000	1000	30	5.7	1
8824610	151-1250	1250	30	7.1	1
8824880	151-1500	1500	30	8.4	1

152

CROWBAR

- ✔ Heavy-duty model
- ✔ With round head and point



Code	No.	l-mm	Ø		
8824960	152-1000	1000	30	5.8	1
8825180	152-1250	1250	30	7.1	1
8825260	152-1500	1500	30	8.4	1



FORESTRY AND CARPENTER'S TOOLS

Out of the forge ...
... and into the forest



1 The forged blanks are sawn off from rolled C60 tempering steel.



2 The red-hot blank is shaped on a forging press and the hole is made for the eye. Excess burring is removed.



3 The glowing blade is beaten out on the forging roll.



4 Final shaping under the forging hammer. Trimming excess material and rough-grinding the axe.



5 Permanent marking by means of a stamp bearing the manufacturer's symbol. Tempering (hardening and tempering) the cutting edge ensures hardness and toughness.



6 Sand-blasting the surface. Fine-grinding the cutting edge. A crowned cut increases stability. Transparent varnish protects the axe head from corrosion.

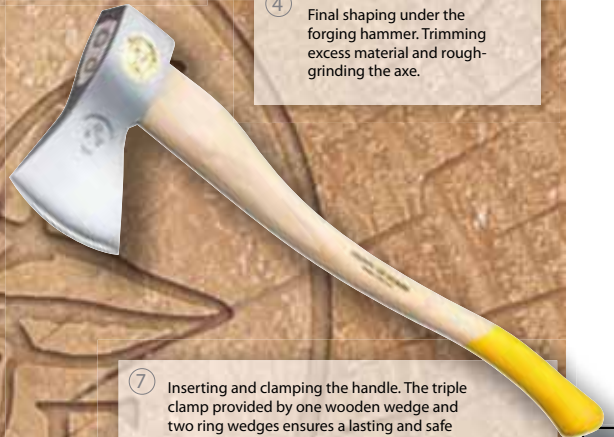

7 Inserting and clamping the handle. The triple clamp provided by one wooden wedge and two ring wedges ensures a lasting and safe connection.

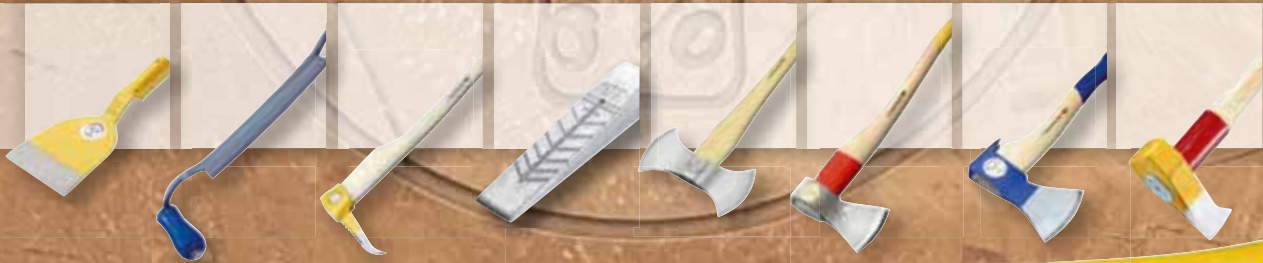

INFO@OCHSENKOPF.COM
WWW.OCHSENKOPF.COM







FOR ALL OCCASIONS –



++ THE IDEAL TOOL ++



FILES



464

SAWS



465

PARALLEL VICES



466

MEASURING TOOLS



466 - 468

THREAD WORKINGS



468 - 469

VARIOUS



469



TOOLS FOR BICYCLES



470 - 471

INDUSTRIAL CUTLERY



472 - 475

SCREW CLAMPS



476 - 479

WORK LIGHTS



480 - 483

AT WORK



484 - 487



FILES

8729

CONTACT FILE

- ▶ In blue PVC tear-off wallet



Code	No.	«inch»	«mm»	Cut	↕	📦
6771080	8729	6	150	2	9	10

8728

KEY FILE SET 6 pieces

- ▶ Acc. to DIN 7283
- ▶ In blue plastic wallet

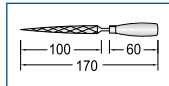

Code	No.	5 types	Cut	↕	📦
6771910	8728	■ ▲ ● ◐ ◑	2	150	1

8730

DEBURRER

- ▶ A valuable helper for removing burr on a wide range of different materials
- ▶ The small, free-turning deburring knife adjusts to the contour of the workpiece and removes burr

▶ **Consisting of:**

- 676 Driving handle
- 699 Bit holder
- E-8730 Deburrer bit 1/4" hex

6,3

1/4



Code	No.	Description	↕	📦
2190907	8730	Deburrer	90	1
2190915	E-8730	Deburrer bit 1/4" hex	5	1

8701

HAND FILE

- ▶ PVC handle
- ▶ DIN 7261, Form A
- ▶ Cut: 2



Code	No.	L	L'	W	H	Cut	↕	📦
6768020	8701 2-6	150	6	16	4	2	96	1
6768100	8701 2-8	200	8	20	5	2	183	1
6768290	8701 2-10	250	10	25	6	2	323	1

8719

TRIANGULAR FILE

- ▶ PVC handle
- ▶ DIN 7261, Form C
- ▶ 2-6 = not standardised
- ▶ Cut: 2



Code	No.	L	L'	W	Cut	↕	📦
6769260	8719 2-6	150	6	10	2	81	1
6769340	8719 2-8	200	8	14	2	177	1
6769420	8719 2-10	250	10	17	2	304	1

8722

ROUND FILE

- ▶ PVC handle
- ▶ DIN 7261, Form F
- ▶ Cut: 2



Code	No.	L	L'	Ø	Cut	↕	📦
6770000	8722 2-6	150	6	6.0	2	57	1
6770190	8722 2-8	200	8	7.5	2	112	1
6770270	8722 2-10	250	10	9.5	2	186	1

8725

HALF-ROUND BLUNT FILE

- ▶ PVC handle
- ▶ DIN 7261, Form E
- ▶ Cut: 2



Code	No.	L	L'	W	H	Cut	↕	📦
6770350	8725 2-6	150	6	16	4.5	2	91	1
6770430	8725 2-8	200	8	20	6.0	2	170	1
6770510	8725 2-10	250	10	25	7.0	2	285	1

➔ **95 • 130**



**450
447**

➔ **600 H**



428

➔ **420**



538



SAWS

401

SMALL SAW FOR METAL

- Mini-hacksaw, bright nickel-plated
- Saw blade 401 A



Code	No.	↳mm↳	↳Inch↳	↕	☰
6500050	401	350	13.3/4	226	1
5500000	401 A	200		12	10

402

KEYHOLE SAW

- Metal handle with two replaceable saw blades: one for metal (402 A), one for wood (402 B)
- Handle enamelled silver



Code	No.	↳mm↳	↳Inch↳	↕	☰
6500130	402	380	14.3/8	221	1
5500190	402 A	260		62	5
5500270	402 B	280		50	1

403

HACKSAW

- Adjustable tubular steel frame
- For 10" and 12" hacksaw blades, complete with No. 403 A-405 A
- Saw blades single-sided (403 A-405 A) and double-sided (403 B-405 B)
- Handle enamelled



Code	No.	Description	↳mm↳	↳Inch↳	↕	☰
6500210	403	Hacksaw	410	18.1/2	411	1
5500350	403 A-405 A	Saw blade, single-sided			28	10
5500430	403 B-405 B	Saw blade, double-sided			41	10

404

SMALL SAW FOR METAL PUK

- Bright nickel-plated
- Saw blade 404 A-406 A



Code	No.	Description	↳mm↳	↳Inch↳	↕	☰
6500480	404	Small saw for metal PUK	290	11	107	1
5501080	404 A-406 A	Saw blade	145	3	10	

406

HOBBY SAW

- For wood and metal
- Made from flat bar, 10 x 5 mm, zinc-plated
- Glass-fibre reinforced plastic handle
- Reach 50 mm
- For use with junior hacksaw blades 145 mm
- Saw blade 404 A-406 A



Code	No.	Description	↳mm↳	↳Inch↳	↕	☰
6501020	406	Hobby saw	250	10	168	1
5501080	404 A-406 A	Saw blade	145		3	10



407

HACKSAW

- Very light hacksaw in pressure-cast aluminium
- Ergonomic soft rubber hand grips
- Fixing of the sawblade by simple turning the blue clamping element in the hand grip
- Clamping piece adjustable by 40°
- Saw blade bimetal 407 A



Code	No.	Description	↕	☰
1879375	407	Hacksaw	650	1
1879383	407 A	Saw blade bimetal	55	1



372

UNIVERSAL HAND SAW

- For PE-, PVC-, wood, copper and aluminium pipes
- Sawblade bimetal (break-proof), length 300 mm
- PE or PVC pipes can be cut flush to the wall
- The replaceable saw blade can be set to 5 positions at the handle
- Especially suited for flush cutting in confined spaces
- As the saw blade works on tension it permits maximum control on the saw for a straight cut
- Effortless fine cuts due to an extremely thin saw blade



Code	No.	Description	↕
1874853	372012	Universal hand saw 12 tpi	220
1874888	372018	Universal hand saw 18 tpi	220
1874896	372026	Universal hand saw 26 tpi	220
1874845	372000	Spare handle	165
1874918	372112	Saw blade 12 tpi	55
1874926	372118	Saw blade 18 tpi	55
1874934	372126	Saw blade 26 tpi	55



PARALLEL VICES

409 - 410

PARALLEL VICE

- Welded
- Compact design, with large anvil surface
- Protected vice spindle with rolled thread



Code	No.	mm	mm	mm	
6500800	409	100	100	7.0	1
6500990	410	150	150	16.4	1

411

PARALLEL VICE

- Sturdy design, with jaws, anvil plate and slides polished and induction hardened
- In heat-treated steel
- Stove enamelled blue



Code	No.	Description	mm	mm	mm	
6501100	411-125	Parallel vice 125x150 mm	125	150	12480	1
6501290	411-150	Parallel vice 150x200 mm	150	200	18474	1
5704430	E-411 A-125	Aluminium jaws 125 mm	125		186	1
5704510	E-411 A-150	Aluminium jaws 150 mm	150		218	1
5704270	E-411 R-125	Pipe-clamping jaws 125 mm	125		794	1
5704350	E-411 R-150	Pipe-clamping jaws 150 mm	150		778	1



MEASURING TOOLS

4533

FOLDING RULE

- Made of branch free beechwood with invisible metal fittings
- Riveted joint guarantees correct measurement even in humid or dry conditions
- With easy to read metric dual scale
- Accuracy class III
- EG-design approval for continuous mm division

4533-1

- Compact 1 m model
- Special for engineers, technicians, or businessmen
- Saves lots of place - suitable for jackets, suits or handbag
- Links 2.3 x 12 mm

4533-2

- Robust 2 m model with brass protective caps
- Most suitable for craftsmen or do-it-yourselfers
- Links 3.0 x 16 mm



Code	No.	Lm	mm	
1837079	4533-1	1	31	1
1837087	4533-2	2	86	1

4534

STEEL TAPE MEASURE

- With belt clip and rewind stop
- mm-divisions
- Approved standard mark



Code	No.	Lm	mm	mm	
6697920	4534-3	3	13	128	5
6698060	4534-5	5	19	220	5
6698140	4534-8	8	25	365	1

702

FEELER GAUGE SET, FAN PATTERN

- With protective handle, folding, blade length 100 mm
- 702 22 A + 702 26 A** each increasing by 1/1000"
- Handle nickel-plated



Code	No.	mm	mm	mm																				
6547520	702 8 M	5	10	15	20	25	30	40	50/100	37	5													
6547600	702 88 M	3	4	5	6	7	8	9	10/100	27	5													
6547790	702 13 M	5	10	15	20	25	30	40	50	60	70	80	90	100/100	65	10								
6547870	702 20 M	5	10	15	20	25	30	35	40	45	50	55	60	65	70	75	100	10						
6547950	702 21 M	10	12	14	16	18	20	22	24	26	28	30	32	34	36	38	40	42	44	46	48	50/100	68	5
6548250	702 8 A	.002	.004	.006	.008	.010	.012	.015	.020"	33	1													
6548410	702 11 A	.0015	.002	.003	.004	.006	.008	.010	.012	.015	.020	.025"	38	1										
6548680	702 13 A	.002	.003	.004	.005	.006	.008	.010	.012	.015	.020	.025	.030	.035"	55	5								
6548760	702 22 A	.004	.025"	81	5																			
6548840	702 26 A	.0015	.025"	80	1																			

**703 M****VALVE FEELER GAUGE**

- Blade length 75 mm



Code	No.			
6549140	703 M	10 15 20 25 30 35 40/100	11	1

705 M**SPARK PLUG GAUGE**

- With electrode adjuster, gauge wires in precision steel wire



Code	No.	\varnothing mm			
6549570	705 M	40 50 60 70 75 80 90 100/100 mm	27	1	

706**THREAD GAUGE**

- For metric and Whitworth threads
- Pitches 0.25-6.00 mm / 62-4 Step" W



Code	No.			
6549730	706	83	10	

710**POCKET VERNIER CALLIPER**

- DIN 862, Form A 2
- For internal and external measurements, with polished tips, depth gauge and high-speed setting
- Graduated in mm and inches, vernier 1/20 and 1/128"
- In leather wallet



Code	No.	\pm mm \pm	mm \square	"inch \square		
6555030	710	213	140	5.1/2	171	1

710-80**VERNIER CALLIPER, SMALL**

- With inside and outside jaws, ground tips, depth gauge
- In leather pouch



Code	No.	\pm mm \pm	mm \square	"inch \square		
1933205	710-80	114	80	3.1/8	100	1

711**DIGITAL MEASURING CALLIPER**

- Stainless steel, hardened
- Switchable from mm to inch
- Accuracy: 0.03 mm - 0.001 inch
- Reading: 0.01 mm - 0.001 inch
- In sturdy protective case



Code	No.	\pm mm \pm	mm \square	"inch \square		
6550070	711	230	153	6	408	1

**745****SCRIBER**

- Made from special steel



Code	No.	\pm mm \pm		
6559530	745	250	58	10

746**CARBIDE SCRIBER**

- Carbide, silver, with retractable, replaceable tip (E-746)



Code	No.	\pm mm \pm		
6559610	746	140	22	10
5545100	E-746	35	2	1



720
TWEEZERS
 With angled tips
 Bright nickel-plated

Code	No.	↳mm↳	↳mm↳	↳mm↳
6556270	720	150	25	5

722-1 ESD
PRECISION TWEEZERS ESD
 Flat, fine, long points
 Satin non-glare finish
 ESD = electrostatic discharge protection, black

Code	No.	↳mm↳	↳mm↳	↳mm↳
1881663	722-1 ESD	130	22	1

722-3/-4
ELECTRONIC TWEEZERS
 Curved, fine, long points
 722-4 double curved
 Satin non-glare finish

Code	No.	↳mm↳	↳mm↳	↳mm↳
1881698	722-3	122	16	1
1881701	722-4	122	16	1

721
CROSS TWEEZERS
 With straight tips
 Bright nickel-plated

Code	No.	↳mm↳	↳mm↳	↳mm↳
6556350	721	160	33	1

722-2
PRECISION TWEEZERS
 Flat, fine points
 Satin non-glare finish

Code	No.	↳mm↳	↳mm↳	↳mm↳
1881671	722-2	95	10	1

722-5/-6
WATCHMAKER TWEEZERS
 722-5 straight, fine, long points
 722-6 bent, fine, long points
 Satin non-glare finish

Code	No.	↳mm↳	↳mm↳	↳mm↳
1881728	722-5	108	12	1
1881736	722-6	108	10	1

722-1
PRECISION TWEEZERS
 Flat, fine, long points
 Satin non-glare finish

Code	No.	↳mm↳	↳mm↳	↳mm↳
1881655	722-1	130	22	1



THREAD WORKINGS



8552
SCREW EXTRACTOR SET
 For extracting broken screws and bolts with threads M5 - M16
 In handy plastic case, with twist drills, guide sleeves, extractor pins and extractor nuts
 Dimensions: 200 x 120 x 38 mm
 Complete with instructions

Code	No.	Contents	↳mm↳	↳mm↳
6755550	8552-025	Extractor pins size 1 2 3 4 5 Drilling sleeves 1 2 3 4 5 6 7 8 9 10 Extractor nuts size 10 11 13 14 17 Drills 8.7-11/32" 8-5/16" 6.4-1/4" 4.8-3/16" 3.2-1/8"	790	1



140
THREAD FILE
 For repairing damaged internal and external threads
 Chrome-vanadium steel, ISO-nickel-plated
 140 metric threads
 140 A inch threads
 140 W Whitworth threads

Code	No.	↳mm↳	for thread pitches	↳mm↳	↳mm↳
6409640	140	230	0.80 1.00 1.25 1.50 1.75 2.00 2.50 3.00 mm	125	1
6409720	140 A	230	24 20 18 16 14 13 12 11 inch	125	1
6409800	140 W	230	24 20 18 16 14 12 11 10 Whitworth	124	1

8551
BOLT EXTRACTOR
 Drill a central hole into the broken bolt (see table)
 Turn the bolt extractor to the left into this hole until it grips and removes the bolt (penetrating oil may be necessary!)
 Always choose the largest possible extractor size

Code	No.	↳mm↳	↳mm↳	Ø	Bore	↳mm↳	↳mm↳	↳mm↳
6758490	8551 1	M3 - M6	1/8-1/4	1,4-3,6	1,8	2,7	50	5 10
6758570	8551 2	M6 - M8	1/4-5/16	2,1-4,9	2,6	3,8	57	9 10
6758650	8551 3	M8 - M11	5/16-7/16	3,1-5,5	3,7	4,9	65	15 10
6758730	8551 4	M11 - M14	7/16-9/16	4,8-8,8	5,5	7,0	70	30 10
6758810	8551 5	M14 - M18	9/16-3/4	6,2-11,0	7,0	9,0	80	51 5
6759030	8551 6	M18 - M24	3/4-1	9,4-15,0	10,3	12,0	85	98 5
6759110	8551 7	M24 - M33	1-1.3/8	12,7-19,0	13,7	14,5	95	162 1
6759380	8551 8	M33 - M45	1.3/8-1.3/4	17,5-24,0	18,6	18,0	100	283 1

**8551****BOLT EXTRACTOR SET**

- ▶ In plastic case



Code	No.	Contents		
6759620	8551-55	1 2 3 4 5	117	1
6759700	8551-66	1 2 3 4 5 6	221	1
6759890	8551-88	1 2 3 4 5 6 7 8	724	1

8553**TAP AND DIE SET**

- ▶ In plastic case
- ▶ For internal threads M3 - M6
- ▶ For external threads M3 - M6, max. 40 mm long
- ▶ Ratchet drive system with extension unit
- ▶ Additional guide sleeve for dies to ensure accurately aligned thread cutting along the bar axis, with swarf collector
- ▶ **Drives:** Ratchet with extension
- ▶ **Taps:** Quick-clamp tap wrench with M3-M6 taps
- ▶ **Dies:** Die handle with guide disc and M3-M6 dies
- ▶ **Accessories:** Fixing screws and angle screwdriver, instruction manual



Code	No.	Contents		
1939068	8553	T-handle ratchet 2093 U-3 T Hex socket key 2 mm Extension, 1/4" 4 mm Die holder Quick-clamp tap wrench Threaded stud M4x6 Backing washer Guide disc M3 M4 M5 M6 Dies M3 M4 M5 M6 Taps M3 M4 M5 M6	510	1

VARIOUS**8272****UNIVERSAL PLIERS**

- ▶ With adjustable joint and protection against clamping
- ▶ Non-slip handles, slightly angled jaw position
- ▶ In heat-treated steel as per EN 10083



Code	No.	↳mm↳	↳inch↳		
6738620	8272-165 C	165	6	189	1
6738890	8272-200 C	200	8	259	1

644 - 646**WIRE BRUSH**

- ▶ With untreated wooden handle, angled pattern, smooth, cast steel wire bristles



Code	No.	Execution	↳mm↳		
6531600	644	3-row	290	137	5
6531870	646	6-row	290	156	5

645**FILE BRUSH**

- ▶ With carded cover and wooden handle
- ▶ Bristle field 110 x 40 mm



Code	No.	↳mm↳		
6531790	645	250	95	10

**228 - 220****526 - 528**



TOOLS FOR BICYCLES



6002

WRENCH FOR SPOKES

- ▶ Forged
- ▶ GEDORE vanadium steel 31CrV3, zinc-plated, chromated
- ▶ Applicable also for motorcycles



Code	No.	Ø mm	l mm	l mm	l mm
6451170	6002 3,3	3.3	30		1
6451410	6002 3,5	3.5	32		1
6451680	6002 3,9	3.9	32		1
6451760	6002 4	4.0	32		1
6451840	6002 4,3	4.3	32		1
6451920	6002 4,5	4.5	30		1
6452060	6002 4,6	4.6	28		1
6452140	6002 4,8	4.8	30		1
6452220	6002 5	5.0	32		1
6452300	6002 5,2	5.2	32		1
6452490	6002 5,5	5.5	30		1
6452570	6002 5,7	5.7	30		1
6452650	6002 6,1	6.1	28		1
6452730	6002 6,5	6.5	30		1

6003

ALIGNING TOOLS FOR TREADLES



Code	No.	l mm	l mm	l mm
6451250	6003	504	1140	1

6004

HEXAGON SOCKET KEY

- ▶ Designed for removal of the sprockets on SRAM rear wheels



Code	No.	Ø mm	l mm	l mm
6451330	6004	12	288	1



6101

HUB CONE SPANNER

- ▶ Very flat forged open end spanners for different screw couplings, head thickness 2.2 mm
- ▶ For SRAM hubs
- ▶ GEDORE vanadium steel 31CrV3, phosphated



Code	No.	Ø mm	l mm	l mm	l mm
1549146	6101 13	13	193	74	1
1549154	6101 14	14	193	78	1
1549162	6101 15	15	193	76	1
1549170	6101 16	16	193	76	1
1549189	6101 17	17	193	70	1
1549197	6101 18	18	193	76	1
1582038	6101 19	19	193	74	1
1809741	6101 20	20	193	74	1
6451090	6101 22	22	193	111	1

6105

WRENCH FOR PEDALS

- ▶ With same size each end and heads flat offset, head thickness 4.5 mm
- ▶ GEDORE vanadium steel 31CrV3, chrome-plated



Code	No.	l mm	Ø mm	l mm	l mm
1549138	6105	340	15	210	1

6160

HANDLE FOR FITTINGS



Code	No.	l mm	l mm	l mm
1560778	6160	180	320	1

6161

FITTINGS PARING SPANNER

- ▶ Tempered steel C45, chrome-plated



Code	No.	Ø mm	Ø mm	l mm	l mm
1560719	6161	36	41	126	149

6162

FITTINGS

- ▶ Tempered steel C45, chrome-plated



Code	No.	Ø mm	l mm	l mm	l mm
1560727	6162 30	30	124	159	1
1578537	6162 32	32	124	151	1
1578545	6162 34	34	124	148	1
1578553	6162 35	35	124	147	1
1578561	6162 36	36	124	144	1
1578588	6162 40	40	124	138	1
1578596	6162 42	42	124	135	1

6163

FITTING OPEN ENDED SPANNER

- ▶ Tempered steel C45, chrome-plated



Code	No.	Ø mm	l mm	l mm	l mm
1560735	6163 15	15	124	173	1

6164

FITTING HOOK SPANNER

- ▶ Tempered steel C45, chrome-plated



Code	No.	Ø mm	l mm	l mm	l mm
1560743	6164	44	124	137	1

329001

SIPHON TRAP PLIERS / SPRING HOOK WRENCH

- ▶ With plastic jaws



Code	No.	Ø mm	l mm	l mm	l mm
1984381	329001	20-65	230	300	1

8386

CONNECTOR PLIERS

- ▶ With lap joint
- ▶ 3 settings
- ▶ Protects sensitive surfaces
- ▶ Particularly suitable for Canon-Connectors or other screw connectors
- ▶ Plastic jaws bolted and replaceable (No. E-8386), jaw width 11 mm
- ▶ GEDORE high-performance hardened and tempered steel, chrome-plated
- ▶ Handles dip-insulated



Code	No.	mm	l mm	l mm
2003481	8386	20-60	300	1
2003694	E-8386			1



6166-18

BICYCLE COMPACT TOOL 18 pieces

- ▶ Compact tool with 18 functions
- ▶ Intelligent division into 2 halves, easy handling of all functions
- ▶ Rounded, flat shape reduces the risk of injury in crashes, when carried in the jersey pocket
- ▶ 2 tyre levers integrated in hafts
- ▶ Chain tool - for up to 10-plate chains
- ▶ Box wrench 8, 10mm
- ▶ Screwdriver slotted / cross-slotted PH
- ▶ Spoke wrench G14, G15
- ▶ INBUS® wrench 2*, 2.5, 3, 4, 5, 6, 8
- ▶ TORX® wrench T20®, T25
- ▶ * Sizes supplied separately (for self-exchange)
- ▶ Made from Vanadium Plus steel
- ▶ Supplied in neoprene pouch for the jersey pocket, or carrying on a belt or saddle
- ▶ Dimensions: 98 x 50 x 25 mm
- ▶ TORX® = reg. trademark of Acument Intellectual Properties, LLC. USA
- ▶ INBUS® = reg. trademark of Acument GmbH & Co. OHG, 56567 Neuwied



Code	No.	mm	mm	mm
1953079	6166-18	223		1

6166-20

BICYCLE COMPACT TOOL 20 pieces

- ▶ Compact tool with 20 functions
- ▶ 2 separate tyre levers made from hard-wearing plastic
- ▶ Chain tool
- ▶ Box wrench 6, 11, 12 and open wrench 8, 10, 13, 15
- ▶ Screwdriver slotted / cross-slotted PH
- ▶ Spoke wrench G14, G15
- ▶ INBUS® wrench 2.5, 3, 4, 5, 6, 8
- ▶ Made from Vanadium Plus steel
- ▶ Dimensions: 94 x 40 x 35 mm
- ▶ INBUS® = reg. trademark of Acument GmbH & Co. OHG, 56567 Neuwied



Code	No.	mm	mm	mm
1888498	6166-20	235		1

6170-07

TOOL SET FOR BICYCLE 7 pieces



Code	No.	Contents	mm	mm
1888471	6170-07	1 handle No. 6160 1 fitting paring spanner No. 6161 1 fitting hexagon/octagon No. 6162 32 1 fitting hexagon/octagon No. 6162 36 1 fitting hexagon/octagon No. 6162 40 1 fitting open end spanner No. 6163 15 1 fitting hook spanner No. 6164	1400	1

8317

BOWDEN CABLE CUTTER

- ▶ For cutting wire rope up to 2 mm diameter and bowden-cable sleeves up to 5 mm diameter
- ▶ Crimping of bowden-cable sleeves and end-sleeves 1.5 mm and 2 mm
- ▶ For medium hard wire
- ▶ With opening spring, transport lock and width adjustment
- ▶ Induction-hardened cutting edges
- ▶ Innovative GEDORE cutting form produces a precision cut
- ▶ Low overall weight



Code	No.	mm	mm	mm
2011638	8317-160 JC	170	150	1



Torque wrenches and accessories



230
-
287



INDUSTRIAL CUTLERY

- ✔ Cutlery is traditionally not made from tempering steel, but from plain carbon steel. Carbon steel is not stainless, but keeps its sharpness longer than stainless steel.
- ✔ All GEDORE scissors are hot, drop-forged.
- ✔ Precisely machined and hardened/tempered.
- ✔ The cutting-edge is manually ground
- ✔ Carbon steel, professional hardening/tempering and the hand-ground cutting edge ensure an optimum cut and cutting-sharpness longevity.

Please ask for our detailed priced leaflet!



SCISSORS

1104

CRAFTSMAN SCISSORS

- ✔ Outstanding cutting performance
- ✔ Suitable for textiles, rubber, wallpaper, plastic, etc.
- ✔ Forged, resharpenable
- ✔ Adjuster screw for later adjustment
- ✔ Fine-polished C45 carbon steel, varnished eyes, silicone dipped RAL 5015
- ✔ Chrome-plated
- ✔ Version L = for left-handers



Code	No.	(mm)		
9118280	1104-18	180	142	5
9118360	1104-20	200	248	5
2082292	1104-20L	200	248	5
9118440	1104-23	230	300	5
9118520	1104-26	260	378	5
2082306	1104-26L	260	378	5
9118600	1104-29	290	446	5
9118790	1104-32	320	536	5

1114

LEATHER SCISSORS

- ✔ Ideal for all kind of leather
- ✔ 9" serrated section
- ✔ Adjuster screw for later adjustment
- ✔ Fine-polished C45 carbon steel, varnished eyes, silicone dipped RAL 5015
- ✔ Chrome-plated



Code	No.	(mm)		
9118950	1114-23	230	282	5





1277

INDUSTRIAL SCISSORS PROFESSIONAL

- ✔ With two equal eyes
- ✔ For universal use
- ✔ Hand-ground
- ✔ Adjuster screw for later adjustment
- ✔ Fine-polished C45 carbon steel
- ✔ Chrome-plated





Code	No.	(mm)		
9119680	1277-10	100	23	5
9119760	1277-12	120	40	5
9119840	1277-16	160	61	5
9119920	1277-18	180	88	5

1350

INDUSTRIAL SCISSORS PROFESSIONAL

- ✔ One large and one small eye for higher transmission of force
- ✔ For universal use
- ✔ Hand-ground
- ✔ Adjuster screw for later adjustment
- ✔ Fine-polished carbon steel
- ✔ Chrome-plated
- ✔ Version L = for left-handers



Code	No.	(mm)		
9120770	1350-16	160	70	5
9120850	1350-18	180	94	5
2082314	1350-18L	180	94	5
9120930	1350-20	200	132	5

2123

PAPER SCISSORS

- ✔ With two equal eyes
- ✔ Suitable for the paper-processing industry and also for wallpapering and use in offices and warehouses
- ✔ Fine-polished C45 carbon steel
- ✔ Chrome-plated



Code	No.	(mm)		
9123790	2123-26	260	178	5

➔ 8250 • 8315



315
316



52887 TE - 55108 TE

SPECIAL SCISSORS

- ▶ Ideal for Kevlar®, aramid and glass fibre
- ▶ Extra hard blades, outside Teflon-coated, inside chrome-plated
- ▶ Fine-serrated on one side
- ▶ Pointed execution
- ▶ Plastic-coated handles
- ▶ Version L = for left-handers
- ▶ Kevlar® is a registered trademark of the company DuPont



Code	No.	l (mm)	mm	g
8017730	52887 TE-V-210	210	252	1
8017750	52887 TE-V-260	260	420	1
2082381	52887 TE-V-320	320	622	1
2082403	52999 TE-V-260L	260	360	1
2082330	53791 TE-V-210	210	272	1
2082373	55108 TE-V-130	130	62	1

8096

SMALL UNIVERSAL SCISSORS

- ▶ With insulation stripping slot
- ▶ Nickel-plated, with blue handle protectors



Code	No.	l (mm)	mm	g
6707900	8096-140	140	75	1



KNIVES

0021

POCKET KNIFE

- ▶ Traditional working knife
- ▶ Folding
- ▶ Universal use
- ▶ Extremely sharp
- ▶ C75 carbon steel blade
- ▶ Weatherproof hardwood handle



Code	No.	l (mm)	mm	g
2016737	0021-07	70	57	10

0038

POCKET KNIFE

- ▶ Anchor or dinghy knife for heavy-duty use
- ▶ Folding
- ▶ Universal use
- ▶ Extremely sharp
- ▶ C75 carbon steel blade
- ▶ Weatherproof hardwood handle



Code	No.	l (mm)	mm	g
9100580	0038-08	80	86	10

0042

CABLE KNIFE

- ▶ With wire stripper
- ▶ Folding
- ▶ Universal use
- ▶ Extremely sharp
- ▶ C75 carbon steel blade
- ▶ Weatherproof hardwood handle



Code	No.	l (mm)	mm	g
9100660	0042-09	90	76	10

0047

POCKET KNIFE

- ▶ With extremely wide blade for heavy-duty use
- ▶ Folding
- ▶ Universal use
- ▶ Extremely sharp
- ▶ C75 carbon steel blade
- ▶ Weatherproof hardwood handle



Code	No.	l (mm)	mm	g
9100740	0047-07	70	64	10
9100900	0047-75	75	86	10
9100820	0047-08	80	98	10

0056

POCKET KNIFE

- ▶ Traditional working knife
- ▶ Folding
- ▶ Universal use
- ▶ Extremely sharp
- ▶ C75 carbon steel blade
- ▶ Plastic handle



Code	No.	l (mm)	mm	g
9101040	0056-07	70	66	10



0063

CABLE KNIFE

- ✔ With wire stripper
- ✔ Folding
- ✔ Universal use
- ✔ Extremely sharp
- ✔ X46Cr13 stainless steel blade
- ✔ Plastic handle





Code	No.			
9101200	0063-08	80	92	10

0059 - 0067

POCKET KNIFE

- ✔ Traditional working knife
- ✔ Folding
- ✔ Universal use
- ✔ Extremely sharp
- ✔ C75 carbon steel blade
- ✔ Weatherproof hardwood handle





Code	No.			
9101470	0067-07	70	61	10
9101390	0065-09	90	78	10
9101120	0059-10	100	102	10

0117

WORK KNIFE

- ✔ Ideal as a packaging, boxing, warehousing or paper knife
- ✔ Extremely sharp
- ✔ C75 carbon steel blade
- ✔ Beech handle



Code	No.			
9102520	0117-10	100	70	10
9102600	0117-12	120	80	10
9102790	0117-16	160	106	10
9102870	0117-18	180	110	10

0246

INDUSTRIAL KNIFE

- ✔ Wide blade with straight back
- ✔ Extremely sharp
- ✔ C75 carbon steel blade
- ✔ Beech handle





Code	No.			
9106860	0246-16	160	98	10

0291

UNIVERSAL KNIFE

- ✔ Universal use
- ✔ Extremely sharp
- ✔ C75 carbon steel blade
- ✔ Beech handle



Code	No.			
9107910	0291-06	60	175	37

0365

UNIVERSAL KNIFE

- ✔ Stainless steel
- ✔ Handle made from cherrywood



Code	No.			
9109290	0365-07	70	39	10

0513

CABLE KNIFE

- ✔ With wire stripper
- ✔ Folding
- ✔ Universal use
- ✔ Extremely sharp
- ✔ C70 carbon steel blade
- ✔ Weatherproof hardwood handle



Code	No.			
9113050	0513-09	90	80	10



S 8140 A



338





4522

ELECTRICIANS' CABLE KNIFE

- With wire stripper
- Folding blade
- Rosewood-faced handle



Code	No.	85	195	75	10
6690240	4522				



SCRAPERS

0175

SCRAPER

- Stamped blade
- Fine-polished, flexible C75 carbon steel
- Glazed beech handle
- Blade width 30 - 120 mm



Code	No.	W	66	10
9103840	0175-03	30	66	10
9103920	0175-04	40	68	10
9104060	0175-05	50	72	10
9104140	0175-06	60	80	10
9104220	0175-08	80	90	10
9104300	0175-10	100	110	10
9104490	0175-12	120	120	10

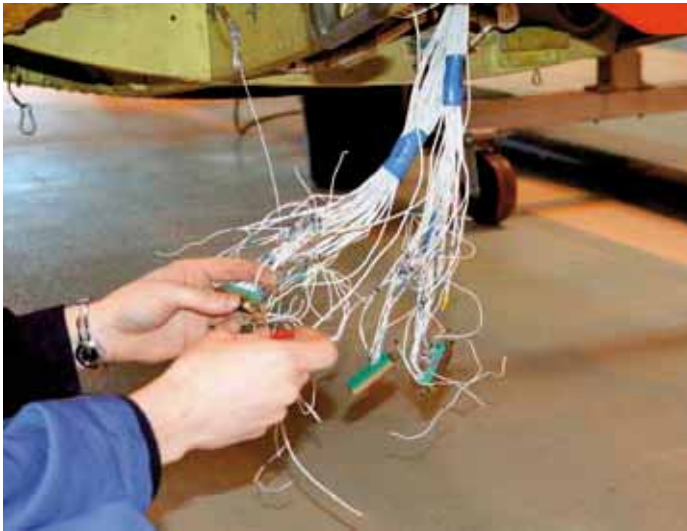

0179

SCRAPER

- Professional version
- Fully forged
- Fine-polished, flexible C50 carbon steel
- Weatherproof hardwood handle
- Handle width 30 - 120 mm

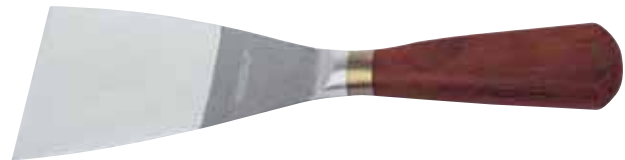

Code	No.	W	47	10
9104570	0179-03	30	47	10
9104650	0179-04	40	63	10
9104730	0179-06	60	84	10
9104810	0179-08	80	120	10
2016745	0179-10	100	132	10
9105110	0179-12	120	144	10

6951

SAFETY KNIFE

- Ideal for the logistics sector
- Wave-ground carbon steel blade
- Blade-shield to protect user from cuts
- Concealed safety foil blade, cuts only when the blue slider is pressed
- Polyamide handle



Code	No.	Description	150	1
2082411	6951-00	Safety knife	150	1
2082438	6951-20	Wave-ground blade	40	1
2082446	6951-50	Dispenser with 10 foil blades	63	1



VDE 4522 • 4527



515





CAST IRON SCREW CLAMPS

FOR DIRECT, SECURED CLAMPING

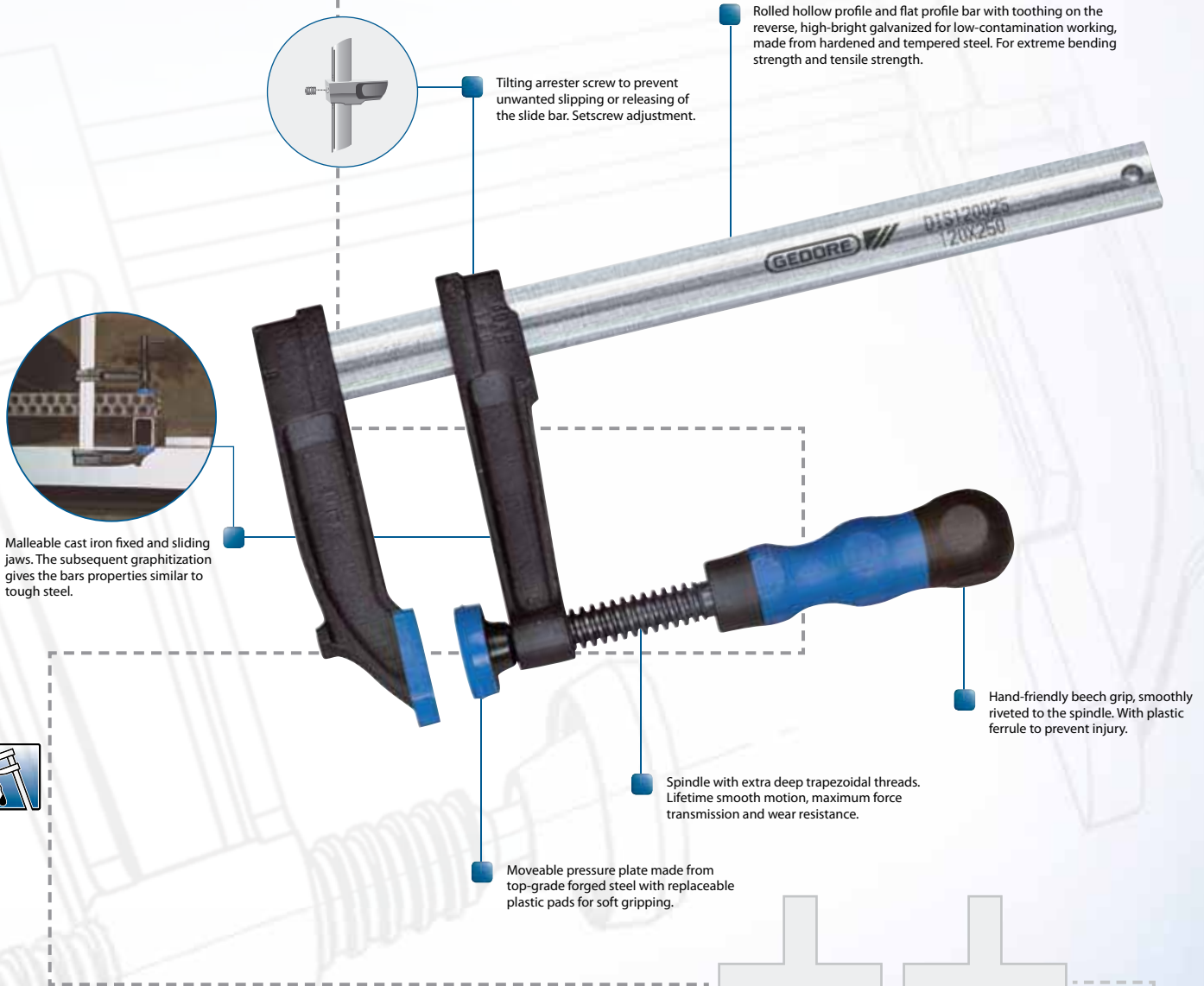

Roller hollow profile and flat profile bar with toothing on the reverse, high-bright galvanized for low-contamination working, made from hardened and tempered steel. For extreme bending strength and tensile strength.

Tilting arrester screw to prevent unwanted slipping or releasing of the slide bar. Setscrew adjustment.

Malleable cast iron fixed and sliding jaws. The subsequent graphitization gives the bars properties similar to tough steel.

Hand-friendly beech grip, smoothly riveted to the spindle. With plastic ferrule to prevent injury.

Spindle with extra deep trapezoidal threads. Lifetime smooth motion, maximum force transmission and wear resistance.

Moveable pressure plate made from top-grade forged steel with replaceable plastic pads for soft gripping.

CLAMPING PLATES FOR SCREW CLAMPS

- ✔ Clamping plates for difficult edges and surfaces
- ✔ Universal size = suitable for all screw clamps
- ✔ With magnetic holder





CAST IRON SCREW CLAMPS

DIS

CAST IRON SCREW CLAMP with wooden handle

- ▶ To DIN 5117
- ▶ Professional clamp for universal use
- ▶ With strong profile-section bar in special steel and rear toothing
- ▶ Pressure plate with exchangeable protective cap
- ▶ Deep trapezoidal thread for optimum transfer of force
- ▶ Clamping arms in sturdy malleable cast iron, with torsionally-resistant H-section
- ▶ With fixing screw for fine adjustment of pressure
- ▶ With beech wood handle



Code	No.	mm [2]	mm [1]	mm [3]	mm [4]
1068849	DIS080016	80	160	25 x 6	0.7
1068938	DIS100020	100	200	30 x 8	1.3
1068989	DIS120025	120	250	30 x 8	1.7
1068997	DIS120030	120	300	30 x 8	1.8
1069004	DIS120040	120	400	30 x 8	2.2
1069012	DIS120050	120	500	30 x 8	2.3
1069020	DIS120060	120	600	30 x 8	2.4
1069039	DIS120080	120	800	30 x 8	2.8
1069047	DIS120100	120	1000	30 x 8	2.7
1401173	DIS120125	120	1250	35 x 11	3.2
1401181	DIS120150	120	1500	35 x 11	3.5
1401203	DIS120200	120	2000	35 x 11	4.5

DIN

CAST IRON SCREW CLAMP with wooden handle

- ▶ To DIN 5117
- ▶ Heavy-duty professional clamp for hard, everyday use
- ▶ Strong flat steel bar with rear toothing
- ▶ Pressure plate with exchangeable protective cap
- ▶ Deep trapezoidal thread for optimum transfer of force
- ▶ Clamping arms in sturdy malleable cast iron, with torsionally-resistant H-section
- ▶ With fixing screw for fine adjustment of pressure
- ▶ With beech wood handle



Code	No.	mm [2]	mm [1]	mm [3]	mm [4]
1170937	DIN050100	50	100	15 x 5	0.3
1171062	DIN060120	65	120	20 x 5	0.6
1171070	DIN060200	65	200	20 x 5	0.6
1171097	DIN060300	65	300	20 x 5	0.7
1069462	DIN140030	140	300	35 x 9	2.2
1069470	DIN140040	140	400	35 x 9	2.5
1069527	DIN175040	175	400	35 x 9	2.7
1069276	DIN121050	120	500	35 x 11	3.0
1069284	DIN121060	120	600	35 x 11	3.3
1069292	DIN121080	120	800	35 x 11	3.9
1069306	DIN121100	120	1000	35 x 11	4.5
1069314	DIN121120	120	1200	35 x 11	5.1
1069322	DIN121150	120	1500	35 x 11	5.9

DISB

CAST IRON SCREW CLAMP with tommy bar

- ▶ For fast, strong clamping with sliding lever handle
- ▶ With strong profile-section bar in special steel and rear toothing
- ▶ Pressure plate with exchangeable protective cap
- ▶ Deep trapezoidal thread for optimum transfer of force
- ▶ Clamping arms in sturdy malleable cast iron, with torsionally-resistant H-section
- ▶ With fixing screw for fine adjustment of pressure
- ▶ With tommy bar with sliding lever handle



Code	No.	mm [2]	mm [1]	mm [3]	mm [4]
1069055	DISB080016	80	160	25 x 6	0.7
1069144	DISB100020	100	200	30 x 8	1.3
1069195	DISB120025	120	250	30 x 8	1.7
1069209	DISB120030	120	300	30 x 8	1.8
1069217	DISB120040	120	400	30 x 8	2.2
1069225	DISB120050	120	500	30 x 8	2.3
1069233	DISB120060	120	600	30 x 8	2.4
1069241	DISB120080	120	800	30 x 8	2.8
1069268	DISB120100	120	1000	30 x 8	3.2



DINB

CAST IRON SCREW CLAMP with tommy bar

- ▶ For fast, strong clamping with sliding lever handle
- ▶ Strong flat steel bar with rear toothing
- ▶ Pressure plate with exchangeable protective cap
- ▶ Deep trapezoidal thread for optimum transfer of force
- ▶ Clamping arms in sturdy malleable cast iron, with torsionally-resistant H-section
- ▶ With fixing screw for fine adjustment of pressure
- ▶ With tommy bar with sliding lever handle



Code	No.	mm [2]	mm [1]	mm [3]	mm [4]
1069586	DINB121050	120	500	35 x 11	3.0
1069594	DINB121060	120	600	35 x 11	3.3
1069608	DINB121080	120	800	35 x 11	3.9
1069616	DINB121100	120	1000	35 x 11	4.5
1069624	DINB121120	120	1200	35 x 11	5.1
1069764	DINB140030	140	300	35 x 9	2.2



ALL-STEEL SCREW CLAMPS +++

FOR OPTIMUM FORCE TRANSMISSION

TGM, TGB, TGP, TGE all-steel screw clamps are primarily used in steel and vehicle construction. Particularly where heavy, sturdy parts need special clamping forces and a high degree of safety is essential.

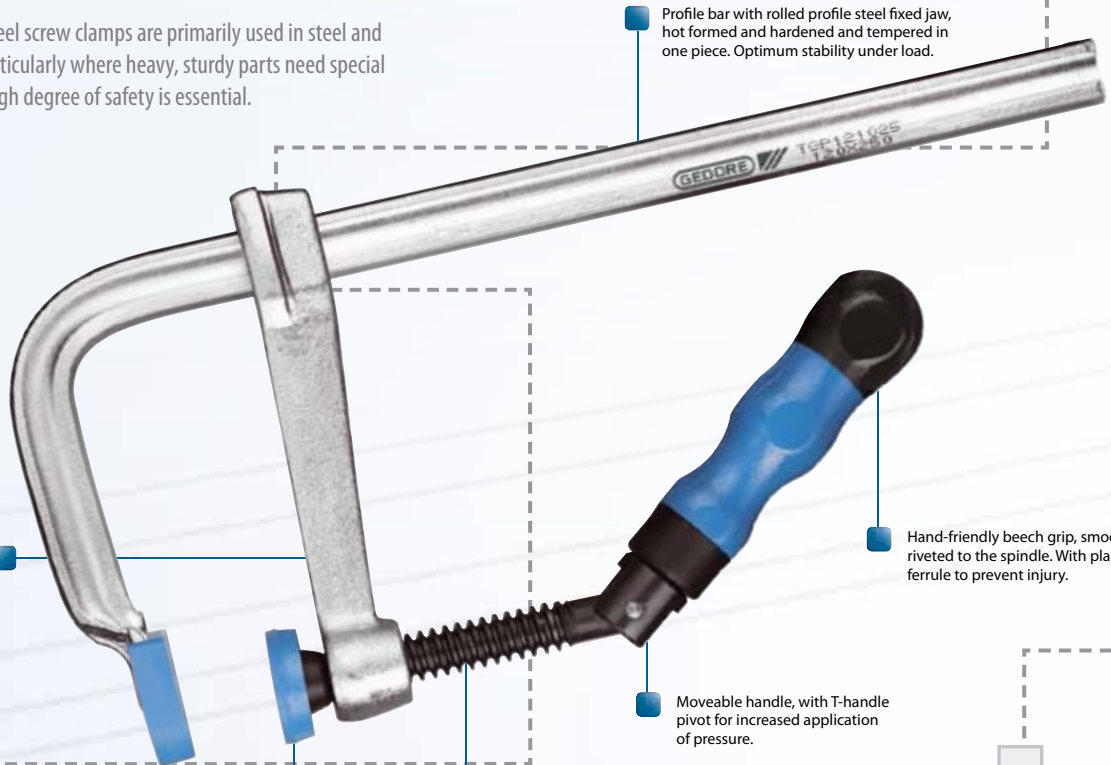

Forged, hardened and tempered steel sliding jaw. Hollow profile and flat profile bars with toothing on the reverse, high-bright galvanized for low contamination working.

Profile bar with rolled profile steel fixed jaw, hot formed and hardened and tempered in one piece. Optimum stability under load.

Hand-friendly beech grip, smoothly riveted to the spindle. With plastic ferrule to prevent injury.

Moveable handle, with T-handle pivot for increased application of pressure.

Spindle with extra deep trapezoidal threads. Lifetime smooth motion, maximum force transmission and wear resistance.

Moveable pressure plate made from top-grade forged steel with replaceable plastic pads for soft gripping.

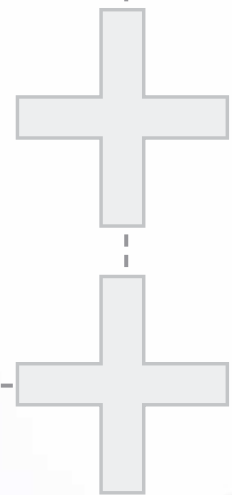

CLAMPING PLATES FOR SCREW CLAMPS

DP 621

CLAMPING PLATES FOR SCREW CLAMPS

- ✔ Clamping plates for difficult edges and surfaces
- ✔ Universal size = suitable for all screw clamps
- ✔ With magnetic holder
- ✔ DP 621-1 With holding tips for uneven, smooth and slippery surfaces
- ✔ DP 621-2 With internal angle for external edges
- ✔ DP 621-3 With external angle for internal edges



Code	No.	Description	↕
1564714	DP 621-1	Clamping plate for holding tips	162
1564757	DP 621-2	Clamping plate with wedge	162
1564803	DP 621-3	Clamping plate with cone	162



ALL-STEEL SCREW CLAMPS

TGM

ALL-STEEL SCREW CLAMP with wooden handle

- For fast, strong clamping - with sliding lever handle
- With hollow-section bar and integral clamping arm
- In cold-drawn profile-section steel, hot-forged to shape and with optimum heat treatment guarantees torsion-free transference of the clamping force
- With forged clamping arm - fitted to slide perfectly
- Movable pressure plate with protective cap
- Deep trapezoidal thread for optimum transfer of force
- In special steel, hardened, bright zinc-plated - for good protection against corrosion and non-dirtying surface
- With beech wood handle



Code	No.	mm	mm	mm	mm
1070096	TGM080016	80	160	16 x 8	0.6
1070118	TGM100020	100	200	20 x 10	1.1
1070126	TGM121025	120	250	22 x 11	1.7
1070142	TGM122030	120	300	25 x 12	2.1
1070150	TGM122040	120	400	25 x 12	2.4
1070169	TGM122050	120	500	25 x 12	2.6
1070177	TGM122060	120	600	25 x 12	2.8
1070185	TGM124080	120	800	25 x 12	4.1
1070193	TGM124100	120	1000	25 x 12	4.7
1070207	TGM124125	120	1250	25 x 12	5.4
1070215	TGM126150	120	1500	25 x 12	7.6
1070134	TGM140030	140	300	25 x 12	2.3

TGP

ALL-STEEL SCREW CLAMP with pivot handle

- For all variable uses requiring sensitivity and force
- The variable handle position permits a sensible combination of handle and tommy bar
- With hollow-section bar and integral clamping arm
- In cold-drawn profile-section steel, hot-forged to shape and with optimum heat treatment guarantees torsion-free transference of the clamping force
- With forged clamping arm - fitted to slide perfectly
- Movable pressure plate with protective cap
- Deep trapezoidal thread for optimum transfer of force
- In special steel, hardened, bright zinc-plated - for good protection against corrosion and non-dirtying surface
- With beech wood handle



Code	No.	mm	mm	mm	mm
1070460	TGP121025	120	250	22 x 11	1.7
1070479	TGP122030	120	300	25 x 12	2.1
1070541	TGP140030	140	300	25 x 12	2.1
1070487	TGP122040	120	400	25 x 12	2.4
1070495	TGP122050	120	500	25 x 12	2.6
1070509	TGP122060	120	600	25 x 12	2.8
1070517	TGP124080	120	800	28 x 14	4.1
1070525	TGP124100	120	1000	28 x 14	4.7
1070533	TGP124125	120	1200	28 x 14	5.4

TGB

ALL-STEEL SCREW CLAMP with tommy bar

- For fast, strong clamping - with sliding lever handle
- With hollow-section bar and integral clamping arm
- In cold-drawn profile-section steel, hot-forged to shape and with optimum heat treatment guarantees torsion-free transference of the clamping force
- With forged clamping arm - fitted to slide perfectly
- Movable pressure plate with protective cap
- Deep trapezoidal thread for optimum transfer of force
- In special steel, hardened, bright zinc-plated - for good protection against corrosion and non-dirtying surface
- With tommy bar with sliding lever handle



Code	No.	mm	mm	mm	mm
1070223	TGB080016	80	160	16 x 8	0.6
1070231	TGB100020	100	200	20 x 10	1.1
1070258	TGB121025	120	250	22 x 11	1.7
1070274	TGB122030	120	300	25 x 12	2.1
1070282	TGB122040	120	400	25 x 12	2.4
1070290	TGB122050	120	500	25 x 12	2.6
1070304	TGB122060	120	600	25 x 12	2.8
1070312	TGB124080	120	800	28 x 14	4.1
1070320	TGB124100	120	1000	28 x 14	4.7
1070339	TGB124125	120	1250	28 x 14	5.4
1070266	TGB140030	140	300	25 x 12	2.3

QUICK-RELEASE LEVER CLAMPS

TGE

QUICK-RELEASE LEVER CLAMP

- For secure, high-pressure clamping, even using only one hand
- With hollow-section bar and integral clamping arm
- In cold-drawn profile-section steel, hot-forged to shape and with optimum heat treatment guarantees torsion-free transference of the clamping force
- High-gloss zinc-plated - for good protection against corrosion and non-dirtying surface
- With fine tooth and pawl mechanism for careful, fast clamping action and high force transference due to lever action
- The clamping force cannot be released or reduced by vibration
- With easy-grip powder-coated handle incorporating a release lever
- The movable clamping arm has a drop-forged, torsion-resistant profile section, and a precise mechanism for providing the highest clamping pressure



Code	No.	mm	mm	mm	mm
1070347	TGE080016	80	160	16 x 8	1.0
1070355	TGE100020	100	200	20 x 10	1.4
1070363	TGE121025	120	250	22 x 11	1.9
1070398	TGE122030	120	300	25 x 12	2.6
1070401	TGE122040	120	400	25 x 12	2.8
1070428	TGE122050	120	500	25 x 12	3.0
1070436	TGE122060	120	600	25 x 12	3.3
1070444	TGE124080	120	800	28 x 14	4.6
1070452	TGE124100	120	1000	28 x 14	5.2
1070371	TGE140030	140	300	25 x 12	2.8



WORK LIGHTS



- ▶ Work lights in industrial quality
- ▶ Protective jacket made of high quality rubber
- ▶ Protective tube made of polycarbonate or PMMA (also used for aircraft screens)



- ▶ GEDORE lamps are equipped with a Euro plug as per EN 50075 or with a shaped plug as per CEE 7/17
- ▶ Euro plugs can be used throughout Europe, except Britain, Ireland, Cyprus and Malta
- ▶ The particular geometry of the shaped plug allows the lamps to be used in more than 100 countries around the world
- ▶ International connectors and other connector variants are available on request



Protection class I

All electrically conductive parts of the equipment casing are connected to the equipment grounding conductor (earthing) system of the fixed electrical installation. Mobile or portable appliances with protection class I have a plug and socket connection with an equipment grounding contact, i.e. an earthing contact. The earthing connection is designed in such a way as to ensure that it is the first connection made, when the plug is inserted into the mains socket, and the last to be disconnected in the event of a fault. The power cable must be fitted with a mechanical strain-relief device at the point of entry into the equipment. If a fault occurs, in which a live conductor comes into contact with the casing, which is connected to earth, an earth contact is normally made, triggering the fuse and cutting the live power feed.



Protection class II

Equipment rated to protection class II has greater insulation or is double insulated, and is not connected to earth. This kind of safety measure is also referred to as protective insulation. Even if such equipment has electrically conductive surfaces, the increased level of insulation ensures that these surfaces are protected from coming into contact with live parts. Mobile or portable appliances with protection class II are not equipped with an earthed plug, that is to say: a three-pin plug is still used, but the earth pin is not connected.



Protection class III

Appliances rated to protection class III work with Safely Extra Low Voltage (SELV) and therefore need no explicit protection. Safely Extra Low Voltage (SELV) lamps are lamps rated at less than 50 V AC or 120 V DC, powered by a safety transformer as per DIN VDE 0551 (EN 60742) or by rechargeable or non-rechargeable batteries.

900 51

HAND LAMP MINI 4

- ▶ Power 4 W
- ▶ Operating voltage of charger 230 V AC/50 Hz
- ▶ Luminous flux 140 lm
- ▶ Protection class II
- ▶ Protection classification IP20
- ▶ T5 bulb; nor replaceable
- ▶ Luminous paint: bright white, colour temperature 4000 Kelvin
- ▶ Permitted ambient temperature of the operating field: -10 to +40° C
- ▶ With electronic ballast. The lamp starts without flickering thanks to the electronic ballast; gentle on the bulb
- ▶ With rotating suspension hook
- ▶ Flexible cable routing as a safeguard against cable fracture
- ▶ Hexagonal housing to stop any rolling away
- ▶ Euro plug with 5 metres cable
- ▶ LxWxH: 350x30x30 mm



Code	No.	↳ mm ↳	↕ mm ↕
2279754	900 51	350	470

900 53

HAND LAMP STANDARD 8

- ▶ Power 8 W
- ▶ Operating voltage 230 V AC/50 Hz
- ▶ Luminous flux 385 lm
- ▶ Protection class II
- ▶ Protection classification IP20
- ▶ T5 bulb; nor replaceable
- ▶ Luminous paint: bright white, colour temperature 4000 Kelvin
- ▶ Permitted ambient temperature of the operating field: -10 to +40° C
- ▶ With electronic ballast. The lamp starts without flickering thanks to the electronic ballast; gentle on the bulb
- ▶ With rotating suspension hook
- ▶ Flexible cable routing as a safeguard against cable fracture
- ▶ Hexagonal housing to stop any rolling away
- ▶ Euro plug with 5 metres cable
- ▶ LxWxH: 500x30x30 mm



Code	No.	↳ mm ↳	↕ mm ↕
2279770	900 53	500	490

900 52 LED

HAND LAMP AKKU LED PRO

- ▶ Rechargeable battery capacity 7.2 V DC/950 mAh
- ▶ Operating voltage of charger 230 V AC/50 Hz
- ▶ Protection class III
- ▶ Protection classification IP54
- ▶ Permitted ambient temperature of the operating field: -10 to +40° C
- ▶ 30 bright white LEDs
- ▶ Charging station with 12 V adapter for cigarette lighter and Euro plug
- ▶ Rechargeable battery Ni-MH, charging time 1.5 h
- ▶ Robust, high-grade housing
- ▶ Protection from rechargeable battery overloading and excessive voltage
- ▶ With rotating suspension hook
- ▶ LxWxH: 350x45x45 mm



Code	No.	↳ mm ↳	↕ mm ↕
2279711	900 52 LED	305	600

**900 54 LED****HAND LAMP PROFI QUICK 36 LED**

- Power 4.5 W
- Operating voltage 24 V DC
- Protection class III
- Protection classification IP54
- Permitted ambient temperature of the operating field: -10 to +40° C
- 36 bright white LEDs
- With rotating suspension hook
- Flexible cable routing as a safeguard against cable fracture
- Hexagonal housing to stop any rolling away
- Inside reflector; with prism protective tub
- Euro plug with 5 metres of cable
- LxWxH: 525x30x50 mm



Code	No.	mm	mm
2279797	900 54 LED	525	675

900 58**HAND LAMP TRUCK 13**

- Power 13 W
- Operating voltage 230 V AC/50 Hz
- Luminous flux 830 lm
- Protection class II
- Protection classification IP54
- T5 bulb; G5 tube socket; replaceable
- Luminous paint: bright white, colour temperature 4000 Kelvin
- Permitted ambient temperature of the operating field: -10 to +40° C
- Robust aluminium inner profile
- With rotating suspension hook
- Shaped plug with 5 metres cable
- LxWxH: 800x33x33 mm



Code	No.	mm
2279800	900 58	755

900 55**HAND LAMP COMPACT 11**

- Power 11 W
- Operating voltage 230 V AC/50 Hz
- Luminous flux 900 lm
- Protection class II
- Protection classification IP54
- PI bulb; G23 tube socket; replaceable
- Luminous paint: bright white, colour temperature 4000 Kelvin
- Permitted ambient temperature of the operating field: -10 to +40° C
- On/off switch
- Shaped plug with 5 metres cable
- LxWxH: 460x38x38 mm



Code	No.	mm
2279738	900 55	550

900 59**HAND LAMP TRUCK 21**

- Power 21 W
- Operating voltage 230 V AC/50 Hz
- Luminous flux 1900 lm
- Protection class II
- Protection classification IP54
- T5 bulb; G5 tube socket; replaceable
- Luminous paint: bright white, colour temperature 4000 Kelvin
- Permitted ambient temperature of the operating field: -10 to +40° C
- Robust aluminium inner profile
- With rotating suspension hook
- Shaped plug with 5 metres cable
- LxWxH: 1140x33x33 mm



Code	No.	mm
2279827	900 59	

**900 56****HAND LAMP PROFI QUICK**

- Power 8 W
- Operating voltage 230 V AC/50 Hz
- Luminous flux 385 lm
- Protection class II
- Protection classification IP54
- T5 bulb; G5 tube socket; replaceable
- Luminous paint: bright white, colour temperature 4000 Kelvin
- Permitted ambient temperature of the operating field: -10 to +40° C
- With electronic ballast. The lamp starts without flickering thanks to the electronic ballast; gentle on the bulb
- With rotating suspension hook
- Flexible cable routing as a safeguard against cable fracture
- Hexagonal housing to stop any rolling away
- Inside reflector
- Shaped plug with 5 metres cable
- LxWxH: 550x33x33 mm



Code	No.
2279789	900 56

900 60**ENGINE SPACE LAMP**

- Power 21 W
- Operating voltage 230 V AC/50 Hz
- Luminous flux 1900 lm
- Protection class II
- Protection classification IP54
- T5 bulb; G5 tube socket; replaceable
- Luminous paint: bright white, colour temperature 4000 Kelvin
- With anti-shatter foil
- Permitted ambient temperature of the operating field: -10 to +40° C
- Dazzle-free lighting of the entire operating area
- Flexible quick-clamp device extendable from 115 - 190 cm
- Fully rubber-protected clamp for trouble-free and rapid fastening
- From aluminium
- Shaped plug with 10 metres cable
- LxWxH: 1140x33x33 mm



Code	No.	mm
2279746	900 60	2700



H 900 60

TELESCOPIC BONNET SUPPORT

- ✔ Flexible quick-clamp device extendable from 115 - 190 cm
- ✔ Fully rubber-protected clamp for trouble-free and rapid fastening
- ✔ From aluminium
- ✔ Spare part for no. 900 60



Code	No.
2279762	H 900 60

H 900

MAGNETIC HOLDER

- ✔ Magnetic system in flat pattern
- ✔ Housing zinc-plated
- ✔ Temperature of use up to 200° C



Code	No.	Tensile force kp	Adhesive force N	Ø
2279819	H 900 01	25	245	50
2279843	H 900 02	28	275	63

900 61

HAND LAMP PRO AKKU DUO LED

- ✔ Rechargeable battery capacity 3.7 V DC/2400 mAh
- ✔ Operating voltage of charger 230 V AC/50 Hz
- ✔ Protection class II
- ✔ Protection classification IP68
- ✔ Permitted ambient temperature of the operating field: -10 to +40° C
- ✔ 3 bright-white LEDs with a minimum 50,000 h service life
- ✔ With a 80° angle of reflected beam, illuminates a four-fold larger working angle than comparable LED inspection lamps
- ✔ Three-fold greater light efficiency than comparable LED inspection lamps
- ✔ Charging unit with euro plug
- ✔ Li-polymer rechargeable battery; max. operating time 4 h
- ✔ Contact-free induction charge, charging time 4 h
- ✔ Break-proof housing



Code	No.
2288672	900 61

901 57

WORKLAMP MEGA POWER 72

- ✔ Power 2x 36 W
- ✔ Operating voltage 230 V AC/50 Hz
- ✔ Luminous flux 5600 lm
- ✔ Protection class I
- ✔ Protection classification IPX4
- ✔ PL bulb; 2G10 bulb socket; replaceable
- ✔ Luminous paint: bright white, colour temperature 4000 Kelvin
- ✔ Permitted ambient temperature of the operating field: -10 to +40° C
- ✔ 2 on/off switches for separate control
- ✔ 2 CEE pattern power points
- ✔ Adjustable support bracket
- ✔ Special reflector
- ✔ Can be mounted on tripod stand ST 901 57 (order separately)
- ✔ Shaped plug with 5 metres cable
- ✔ Dimensions: L 320 x W 320 X H 140 mm



Code	No.	312
2279835	901 57	3852

**901 58****WORKLAMP POWER**

- ▶ Power 2x 18 W
- ▶ Operating voltage 230 V AC/50 Hz
- ▶ Luminous flux 2400 lm
- ▶ Protection class II
- ▶ Protection classification IP44
- ▶ PL bulb; 2G10 bulb socket; replaceable
- ▶ Luminous paint: bright white, colour temperature 4000 Kelvin
- ▶ Permitted ambient temperature of the operating field: -10 to +40° C
- ▶ 2 on/off switches for separate control
- ▶ Adjustable support bracket
- ▶ Shaped plug with 5 metres cable
- ▶ Dimensions: L 350 x W 335 X H 230 mm



Code	No.
2288680	901 58

ST 901 57**TRIPOD STAND, ZINC-PLATED**

- ▶ For worklamp no. 901 57
- ▶ Height-adjustable between 1.1 m to 2.7 m
- ▶ Base stand retractable
- ▶ Incl. fixing screws for height adjustment
- ▶ Fully zinc-plated



Code	No.	↳ mm ↳
2279851	ST 901 57	6500

LM 900 08**SPARE BULB 8 W**

- ▶ Power 8 W
- ▶ Luminous flux 385 lm
- ▶ For tube socket G5
- ▶ Luminous paint: bright white, colour temperature 4000 Kelvin
- ▶ For hand light Profi Quick 900 56

Code	No.	↳ mm ↳	Ø
2279878	LM 900 08	288	16

LM 900 13**SPARE BULB 13 W**

- ▶ Power 13 W
- ▶ Luminous flux 830 lm
- ▶ For tube socket G5
- ▶ Luminous paint: bright white, colour temperature 4000 Kelvin
- ▶ Spare bulb for Worklamp Truck 900 58

Code	No.	↳ mm ↳	Ø
2279886	LM 900 13	517	16

LM 900 21**SPARE BULB 21 W**

- ▶ Power 21 W
- ▶ Luminous flux 1900 lm
- ▶ For tube socket G5
- ▶ Luminous paint: bright white, colour temperature 4000 Kelvin
- ▶ Spare bulb for Worklamp Truck 900 59

Code	No.	↳ mm ↳	Ø
2279894	LM 900 21	849	16.0

LM 900 21 S**SPARE BULB 21 W FOR 900 60**

- ▶ Power 21 W
- ▶ Luminous flux 1900 lm
- ▶ For tube socket G5
- ▶ Luminous paint: bright white, colour temperature 4000 Kelvin
- ▶ With anti-shatter foil
- ▶ Spare bulb for engine space lamp no. 900 60

Code	No.	↳ mm ↳	Ø	
2329921	LM 900 21 S	849	16.0	78.49

LM 900 36**SPARE BULB 2X 36 W**

- ▶ Power 36 W
- ▶ Luminous flux 2800 lm
- ▶ Für bulb type PL
- ▶ For bulb socket 2G10
- ▶ Luminous paint: bright white, colour temperature 4000 Kelvin
- ▶ Spare bulb for Worklamp Mega Power no. 901 57
- ▶ EVG

Code	No.
2279908	LM 900 36



SAFETY AT WORK

TOOL BAGS

WT 1056 1

- HEAVY-DUTY BELT WITH CUSHION**
- ✔ Fits waist size from 80-120 cm (32"-48")
 - ✔ Strongly cushioned for maximum comfort
 - ✔ Made from leather



Code	No.	L	W	
1802410	WT 1056 1	1330	145	450



WT 1056 2

- UNIVERSAL POUCH**
- ✔ Leather pocket for knives
 - ✔ Hammer holder with metal hooks
 - ✔ Hook for tape measure



Code	No.	W	H	
1811096	WT 1056 2	290	290	340

WT 1056 3

- DRILL HOLSTER**
- ✔ Suitable for drill-machines and battery-drills
 - ✔ With pockets for screws and bits
 - ✔ Securing loop as loss-proof



Code	No.	W	H	
1818147	WT 1056 3	210	320	150

WT 1056 4

- HAMMER HOLDER WITH METAL HOOKS**
- ✔ Holds any claw hammer at a comfortable angle
 - ✔ Enables boundless freedom of movement
 - ✔ Polyester and blue suede
 - ✔ Stainless tab



Code	No.	W	H	
1818155	WT 1056 4	100	160	100

WT 1056 5

- THREE-POUCH BELT SET**
- ✔ Fits waist size from 80-120 cm (32"-48")
 - ✔ 4 holsters, 5 storage pockets and 1 eyelet for tape measure



Code	No.	W	H	
1818163	WT 1056 5	690	270	750



WT 1056 6

ELECTRICIANS' POUCH

- Generous pouch space
- 8 pockets for screwdrivers
- Extra pocket for insulation stripping knife
- Holding shackle for insulating tape



Code	No.	W	H	→
1818171	WT 1056 6	240	320	500

WT 1056 7

HEAVY-DUTY BELT SET

- Heavily padded belt for superior comfort when fully loaded
- Fits waist size from 80-120 cm (32"-48")
- Basic belt from leather
- All inclusive: Holster, hammer holder, 2 pockets and mobile phone holder (available separately WT 1056 7-1)



WT 10567-1



Code	No.	(mm)	→
1818198	WT 1056 7	1330	1600
1963171	WT 1056 7-1		52

WT 1056 8

DUO POUCH

- Leather pocket for knives
- 2 large storage pockets



Code	No.	W	H	→
1818201	WT 1056 8	240	280	360

WT 1056 9

ROLL-COVER

- With 12 inside pockets for slim tools, e.g. combination spanners or screwdrivers
- Delivery without tools



Code	No.	W	H	→
1818228	WT 1056 9	320	350	120

WT 1056 10

KNEE PADS, PAIR

- Made of strong synthetic leather with rubber
- Soft lining for comfortable kneeling
- Hook and loop fastener
- Universal size



Code	No.	→
1818236	WT 1056 10	200





WT 1056 11

TOOL RUCKSACK PROFI

- ✔ With extra large capacities
- ✔ Practical and ergonomic arrangement of the internal and external pockets
- ✔ Ideal for transport and storage of tools, accessories and documents
- ✔ Strong zippers
- ✔ Reinforced back, padded adjustable shoulder straps and additional practical handle on the top
- ✔ Tear-resistant polyester fabric with 3M reflective stripes, suede
- ✔ Spray-water repellent, resistant to chemical agents
- ✔ Inured to temperature changes
- ✔ The 3M reflective stripes provide high visibility and extra safety



Code	No.	W	H	D	
1818244	WT 1056 11	300	400	120	2800



WT 1056 12

TOOL RUCKSACK SOFT

- ✔ SOFT rucksack, extremely light and yet strong
- ✔ Tear-resistant polyester fabric and suede
- ✔ Strong and watertight
- ✔ Practical and ergonomic arrangement of the internal and external pockets
- ✔ Ideal for transport and storage of tools, accessories and documents
- ✔ Strong zippers
- ✔ Padded adjustable shoulder straps and additional practical handle on the top
- ✔ Delivery without tools



Code	No.	W	H	D	
1818252	WT 1056 12	380	410	70	1900

WT 1056 13

TOOL VEST

- ✔ Multifunctional tool vest with many pockets and holsters
- ✔ Universal size with 4 lateral buckles
- ✔ Padded pouches of different dimensions for tools and small components
- ✔ Mobile phone holder and reinforced tab to hang a hammer
- ✔ Wide back pouch
- ✔ Net insert in the back for a better transpiration
- ✔ Compartment with window for an identity card
- ✔ Tear-resistant polyester fabric with 3M reflective stripes, suede
- ✔ Spray-water repellent, resistant to chemical agents
- ✔ Inured to temperature changes
- ✔ Delivery without tools



Code	No.	W	H	
1818260	WT 1056 13	480	660	1000



SAFETY AT WORK

923

SAFETY SPECTACLES

- GEDORE safety spectacles with UVEX technology as per DIN EN 166:2006
- Uncompromising safety, design and wearer comfort for continuous wear
- Optimum adjustment to the facial features by individually adjustable arms and lens tilt. Additional skin-friendly soft-component pads moulded to the sensitive contact areas on the nose, ears and temple
- Scratchproof, mist-proof coated lenses with "NanoClean" effect ensure clear vision and are easy to clean
- Advantages of the different lens colours (availability depends on model):
- No. 923-1 colourless: 100% protection against UVA, UVB and UVC radiation as per DIN EN 166 and DIN EN 170
- No. 923-2 blue: 100% protection against UV radiation (UVA, UVB, UVC)
- Complies with DIN EN 172 requirements for the perception of signal colours.
- A slight bluish tint gives a very soothing effect on the human eye, aiding relaxed vision.
- Suitable for all workplaces - without colour check.
- Supplied in a black nylon bag



Code	No.	Execution	↕	📦
1959468	923-1	clear	40	1
1959484	923-2	blue	40	1



924

EAR PLUGS WITH HEAD BAND

- Universal size
- Ideal for off-site and short-term deployments
- Designed for continuous noise up to 95 dB and pulsed noise up to 100 dB
- Secure-fit headband design
- The convex shape of the ear plugs allows them to be hygienically set down with no contact between the ear plugs and the rest
- Lightweight - just 8 g
- Signal yellow replacement plugs E-924, easy to fit, 5 pairs, hygienically packed



Code	No.	↕	📦
1959646	924	80	10
1959751	E-924	20	1



WORK GLOVES

920

WORK GLOVES FASTFIT

- For universal use
- Close fitting for retention of feel and dexterity
- Stage 5 classification as per EN 420/03 (scale from 0 - 5)
- Kind on the skin
- Rugged imitation leather and synthetic material



Code	No.	Size	↕	📦
1938576	920 8	S/8	70	1
1938584	920 9	M/9	70	1
1938592	920 10	L/10	80	1
1938606	920 11	XL/11	80	1
1938614	920 12	XXL/12	80	1

921

WORK GLOVES ORIGINAL

- For heavy duty use
- Close fitting for retention of feel and dexterity
- Stage 5 classification as per EN 420/03 (scale from 0 - 5)
- Rubber reinforced finger tips
- Adjustable Velcro fasteners on the cuffs
- Rugged imitation leather and synthetic material



Code	No.	Size	↕	📦
1938622	921 5	XXXS/5	70	1
1938630	921 6	XXS/6	70	1
1938649	921 7	XS/7	70	1
1938657	921 8	S/8	70	1
1938665	921 9	M/9	80	1
1938673	921 10	L/10	80	1
1938681	921 11	XL/11	90	1
1938703	921 12	XXL/12	90	1
1938711	921 13	XXXL/13	90	1

922

WORK GLOVES M-PACT

- For heavy duty use
- Close fitting for retention of feel and dexterity
- Stage 5 classification as per EN 420/03 (scale from 0 - 5)
- Rubber reinforced finger tips
- Adjustable Velcro fasteners on the cuffs
- Additional knuckle protectors
- Ergonomic palm reinforcement
- Rugged imitation leather and synthetic material



Code	No.	Size	↕	📦
1938738	922 8	S/8	80	1
1938746	922 9	M/9	80	1
1938754	922 10	L/10	80	1
1938762	922 11	XL/11	90	1
1938770	922 12	XXL/12	90	1



730

GEDORE

MADE IN GERMANY

GEDORE

No. 300

R4 R8

R4

15°

26



++ INNOVATIVE CORROSION PROTECTION NC COROSTOP ++



SERVICE / FEATURES		490
COROSTOP NC SLOGGING SPANNERS		491
COROSTOP NC SPANNERS		491
COROSTOP NC SOCKETS + ACCESSORIES		492 - 493
COROSTOP NC SCREWDRIVER		494
COROSTOP NC PLIERS		495
COROSTOP NC PULLERS		496
COROSTOP NC PARTS		496
ACCESSORIES		496
NAUTIC-SETS		497 - 499



i WHAT IS COROSTOP?

COROSTOP (NC) is a special process of surface treatment for preventing corrosion on tools used in wet areas. The tools are specially electroplated to provide corrosion proofing many times greater (at least 500%) than our conventionally coated tools. The protective COROSTOP coating reliably protects the tool, even when it sustains slight surface damage.

→ COMPARATIVE TEST - EFFECT OF NC IN SALT WATER

After 10 days in salty seawater:



1 The surface shows no trace of corrosion



2 The surface has clear traces of rust film

++ NC USE

This method ensures COROSTOP tools are ideally suited to a wide range of marine applications, work on drilling rigs - in fact everywhere where water is present or used in the process and robust tools are required for sustained use.



NC TOOLS AN INNOVATION BY GEDORE



All tools NC marked are COROSTOP-coated!

i Care notes:

After use, rinse the tools with tap water (fresh water) and then wipe dry. This will maintain corrosion proofing over a long period.



COROSTOP NC SPANNERS

Ring slogging spanner LOCK-ON NC 306 S
A safe solution for those firmly-seated connections



NC 306 S Available in all usual sizes:
▶ 24, 27, 30, 32, 34, 36, 41, 46, 50, 55, 60, 65, 70, 80, 90, 95, 100, 115, 120, 130, 135, 145, 150, 155, 165, 170, 175 mm
▶ Prices and further sizes on request (mm, inch)



- ▶ GEDORE's ring slogging spanner NC 306 S embodying the new safety technology
- ▶ The spanner is safely secured to the work, and this is done by fixing the ring slogging spanner in position with a small screw on the ring head
- ▶ Optimum protection against injuries
- ▶ The spanner is safely secured to the work
- ▶ Noticeably greater impact effect when used - this means more effective use of the ring slogging spanner
- ▶ COROSTOP coating for long-life corrosion proofing

The principle:

- ▶ A small locking screw through the head of the slogging spanner grips the side of the bolt to be released. After the slogging spanner has done its job, the screw is slackened off again

NC 7

COMBINATION SPANNER NC with same size each end METRIC

- ▶ Acc. to DIN 3113 Form A, ISO 3318, ISO 7738
- ▶ Ring 15° offset from shaft, shaft in girder pattern
- ▶ GEDORE vanadium steel 31CrV3, with COROSTOP coating, polished rings
- ▶ * not standardised



COMBINATION SPANNER NC with same size each end INCH

- ▶ Ring 15° offset from shaft, shaft in girder pattern
- ▶ GEDORE vanadium steel 31CrV3, with COROSTOP coating, polished rings

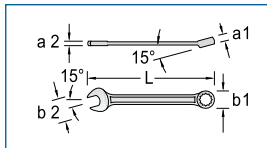

mm

"AF

Code	No.	*	Ømm	L	a ₁	a ₂	b ₁	b ₂	↕	⊞
1669613	NC 7 6		6	100	5.0	3.4	10.0	16.2	14	1
1669621	NC 7 7		7	110	5.5	3.6	11.5	17.5	17	1
1669648	NC 7 8		8	120	6.0	3.8	12.7	19.8	24	1
1669656	NC 7 9		9	130	6.5	4.0	14.0	21.5	28	1
1669664	NC 7 10		10	140	7.0	4.2	15.5	23.0	33	1
1669680	NC 7 12		12	160	8.0	4.8	18.5	27.5	50	1
1669699	NC 7 13		13	170	8.5	5.0	19.5	30.0	58	1
1669702	NC 7 14		14	180	9.0	5.2	21.0	31.8	69	1
1669710	NC 7 15		15	190	9.5	5.5	22.5	34.0	80	1
1669729	NC 7 16		16	200	10.0	5.8	23.0	35.0	92	1
1669737	NC 7 17		17	210	10.5	6.0	25.0	38.0	111	1
1669745	NC 7 18		18	220	11.0	6.2	26.0	40.0	121	1
1669753	NC 7 19		19	230	11.5	6.5	28.0	42.0	140	1
1669761	NC 7 20	*	20	240	12.0	6.8	29.0	44.2	170	1
1669796	NC 7 21		21	252	12.5	7.0	30.0	45.5	182	1
1669818	NC 7 22		22	262	13.0	7.2	32.0	48.0	200	1
1669826	NC 7 24		24	282	14.0	8.0	35.0	52.5	264	1
1669834	NC 7 27		27	310	15.5	8.5	39.0	59.5	344	1
1669842	NC 7 30		30	340	17.0	9.0	43.0	63.0	428	1
1669850	NC 7 32		32	370	18.0	9.5	46.0	68.0	535	1

Code	No.	Ø"AF	L	a ₁	a ₂	b ₁	b ₂	↕	⊞
1803603	NC 7 1/4AF	1/4	100	5.0	3.4	10.0	16.2	14	1
1803611	NC 7 5/16AF	5/16	120	6.0	3.8	12.7	19.8	24	1
1884115	NC 7 11/32AF	11/32	130	6.5	4.0	14.0	21.5	30	1
1803638	NC 7 3/8AF	3/8	140	7.0	4.2	15.5	23.0	38	1
1803646	NC 7 7/16AF	7/16	150	7.5	4.5	17.0	26.0	40	1
1803654	NC 7 1/2AF	1/2	170	8.5	5.0	19.5	30.0	56	1
1803662	NC 7 9/16AF	9/16	180	9.0	5.2	21.0	31.8	62	1
1803670	NC 7 5/8AF	5/8	200	10.0	5.8	23.0	35.0	106	1
1803689	NC 7 11/16AF	11/16	220	11.0	6.2	26.0	40.0	122	1
1803697	NC 7 3/4AF	3/4	230	11.5	6.5	28.0	42.0	154	1
1803700	NC 7 7/8AF	7/8	262	13.0	7.2	32.0	48.0	198	1
1803719	NC 7 1AF	1	302	15.0	8.2	36.0	56.5	288	1



NC 60 P

ADJUSTABLE WRENCH NC open end

- ▶ Acc. to DIN 3117, Form A
- ▶ Swedish pattern, roller with left hand thread
- ▶ Jaw set at 15°
- ▶ With scale
- ▶ GEDORE vanadium steel 31CrV3, with COROSTOP coating, polished heads

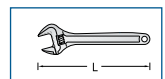

Code	No.	Size "	L	mm	"inch	↕	⊞	
1670220	NC 60 P 8	8	205	25	1	0-25	134	1
1669958	NC 60 P 12	12	305	36	1.7/16	0-36	716	1

www.gedore.com



COROSTOP NC SOCKETS + ACCESSORIES

NC 30

SOCKET NC 3/8" hexagon METRIC

- Acc. to DIN 3124, ISO 2725-1
- Square drive as per DIN 3120 - C 10, ISO 1174, with ball retaining groove
- Hand-operated, knurled grip
- GEDORE vanadium steel 31CrV3, with COROSTOP coating

10

3/8"

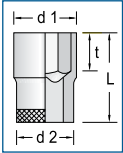

mm

Code	No.	Ø mm	L	d ₁	d ₂	t	↕	⊞
1670239	NC 30 8	8	28	12.1	17.5	9	28	1
1670247	NC 30 10	10	28	14.7	17.5	9	28	1
1670255	NC 30 12	12	28	17.2	18.3	9	33	1
1670263	NC 30 13	13	28	18.5	17.5	9	32	1
1670271	NC 30 14	14	29	19.7	18.4	11	38	1
1670298	NC 30 15	15	30	21.0	19.7	12	44	1
1670301	NC 30 16	16	30	22.2	21.0	12	49	1
1670328	NC 30 17	17	30	23.5	22.3	12	57	1
1670336	NC 30 18	18	30	24.7	23.0	12	62	1
1670344	NC 30 19	19	30	26.0	23.7	12	68	1
1670352	NC 30 20	20	31	27.2	24.5	12	78	1
1670360	NC 30 21	21	31	28.5	25.8	14	86	1
1670379	NC 30 22	22	32	29.7	26.3	14	92	1

SOCKET NC 3/8" hexagon INCH

- Square drive as per DIN 3120 - C 10, ISO 1174, with ball retaining groove
- Hand-operated, knurled grip
- GEDORE vanadium steel 31CrV3, with COROSTOP coating

10

3/8"



"AF

Code	No.	Ø "AF	L	d ₁	d ₂	t	↕	⊞
1803840	NC 30 1/4AF	1/4	28	10.1	17.5	5	23	1
1803859	NC 30 5/16AF	5/16	28	12.1	17.5	9	25	1
1803867	NC 30 11/32AF	11/32	28	13.1	17.5	9	25	1
1803875	NC 30 3/8AF	3/8	28	14.1	17.5	9	26	1

NC D 30

SOCKET NC 3/8" UD profile

- Square drive as per DIN 3120 - C 10, ISO 1174, with ball retaining groove
- Hand-operated, knurled grip
- GEDORE vanadium steel 31CrV3, with COROSTOP coating

10

3/8"

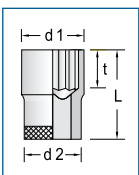

"AF

Code	No.	Ø "AF	L	d ₁	d ₂	t	↕	⊞
1803883	NC D 30 7/16AF	7/16	28	16.1	17.5	9	27	1
1803891	NC D 30 1/2AF	1/2	28	18.1	19.2	9	34	1
1803905	NC D 30 9/16AF	9/16	29	20.1	18.7	12	36	1
1884107	NC D 30 19/32AF	19/32	30	21.0	19.7	12	42	1
1803913	NC D 30 5/8AF	5/8	30	22.1	20.7	12	44	1
1803921	NC D 30 11/16AF	11/16	30	24.0	22.7	12	53	1
1803948	NC D 30 3/4AF	3/4	30	26.0	23.7	12	61	1

NC 3087

SLIDING T BAR NC 3/8"

- Acc. to DIN 3122, ISO 3315
- For hand-operated sockets with square drive as per DIN 3120, ISO 1174, ball locking device
- GEDORE vanadium steel 31CrV3, with COROSTOP coating

10

3/8"



Code	No.	Ø"	Ø"	↕ mm	↕	⊞
1670395	NC 3087	3/8	10	163	130	1

NC 3090

EXTENSION NC 3/8"

- Acc. to DIN 3123, ISO 3316
- For hand-operated sockets with square drive as per DIN 3120, ISO 1174, ball locking device
- GEDORE vanadium steel 31CrV3, with COROSTOP coating

10

3/8"



Code	No.	Ø"	Ø"	↕ mm	↕	⊞
1670409	NC 3090-5	3/8	10	125	110	1

NC 3093 U-10

REVERSIBLE RATCHET NC 3/8"

- Acc. to DIN 3122, ISO 3315
- With lever change and push-button release
- Locks in middle position
- For hand-operated sockets and accessories with square drive as per DIN 3120 - C 10, ISO 1174, ball locking device
- GEDORE vanadium steel 31CrV3, with COROSTOP coating

10

3/8"

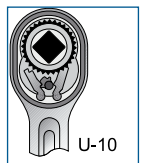

Code	No.	Ø"	Ø"	↕ mm	↕	↕	⊞
1670387	NC 3093 U-10	3/8	10	11,25	200	30,2	246





NC 19

SOCKET NC 1/2" hexagon

- Acc. to DIN 3124, ISO 2725-1
- Square drive as per DIN 3120 - C 12.5, ISO 1174, with ball retaining groove
- Hand-operated, knurled grip
- GEDORE vanadium steel 31CrV3, with COROSTOP coating

12.5

1/2

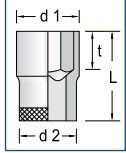

mm

Code	No.	Ømm	L	d ₁	d ₂	t	↺↻	📦
1670417	NC 19 10	10	38.0	15.5	22.5	13.5	56	1
1670425	NC 19 12	12	38.0	18.0	22.5	12.5	58	1
1670433	NC 19 13	13	38.0	19.2	22.5	12.5	61	1
1670441	NC 19 14	14	38.0	20.5	22.5	12.5	63	1
1670468	NC 19 16	16	39.5	22.5	23.8	15.0	75	1
1670476	NC 19 17	17	39.5	24.0	22.5	15.0	74	1
1670484	NC 19 18	18	39.5	25.5	23.0	17.0	73	1
1670492	NC 19 19	19	40.0	26.7	24.2	17.0	85	1
1670506	NC 19 22	22	41.5	30.5	26.3	18.5	112	1
1670514	NC 19 24	24	41.5	33.0	28.0	18.5	132	1
1670522	NC 19 27	27	41.5	36.7	30.0	18.5	157	1
1670530	NC 19 30	30	43.0	40.5	32.5	20.5	193	1
1670549	NC 19 32	32	44.5	43.0	34.5	22.5	218	1

NC 1987

SLIDING T BAR NC 1/2"

- Acc. to DIN 3122, ISO 3315
- For hand-operated sockets with square drive as per DIN 3120, ISO 1174, ball locking device
- GEDORE vanadium steel 31CrV3, with COROSTOP coating

12.5

1/2



Code	No.	1/2"	12.5	mm	↺↻	📦
1670565	NC 1987	1/2	12.5	292	374	1

NC 1990

EXTENSION NC 1/2"

- Acc. to DIN 3123, ISO 3316
- For hand-operated sockets with square drive as per DIN 3120, ISO 1174, ball locking device
- GEDORE vanadium steel 31CrV3, with COROSTOP coating

12.5

1/2



Code	No.	1/2"	12.5	mm	↺↻	📦
1670573	NC 1990-5	1/2	12.5	125	184	1
1670581	NC 1990-10	1/2	12.5	250	354	1

NC 1993 U-10 T

REVERSIBLE RATCHET NC 1/2"

- Acc. to DIN 3122, ISO 3315
- With recessed lever change
- Push-button release
- Locks in the middle position: When the lever is flipped, it automatically engages for clockwise or counterclockwise operation
- For hand-operated sockets and accessories with square drive as per DIN 3120 - C 12.5, ISO 1174, ball locking device
- GEDORE vanadium steel 31CrV3, with COROSTOP coating

12.5

1/2



Code	No.	1/2"	12.5	mm	↺↻	📦
1670557	NC 1993 U-10 T	1/2	12.5	11,25 270	39 592	1



Further sizes with NC finish on request



www.gedore.com

NCD 19

SOCKET NC 1/2" UD profile

- Square drive as per DIN 3120 - C 12.5, ISO 1174, with ball retaining groove
- Hand-operated, knurled grip
- GEDORE vanadium steel 31CrV3, with COROSTOP coating

12.5

1/2

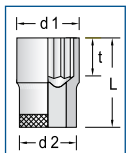

"AF

Code	No.	Ø"AF	L	d ₁	d ₂	t	↺↻	📦
1803727	NCD 19 5/16AF	5/16	38.0	13.0	22.5	7.0	52	1
1803735	NCD 19 11/32AF	11/32	38.0	13.9	22.5	8.0	54	1
1803743	NCD 19 3/8AF	3/8	38.0	14.9	22.5	15.0	55	1
1803751	NCD 19 13/32AF	13/32	38.0	15.9	22.5	13.5	55	1
1803778	NCD 19 7/16AF	7/16	38.0	16.7	22.5	12.5	56	1
1803786	NCD 19 1/2AF	1/2	38.0	18.7	22.5	12.5	58	1
1803794	NCD 19 9/16AF	9/16	38.0	20.7	22.5	12.5	61	1
1803808	NCD 19 19/32AF	19/32	39.5	21.7	22.5	15.0	70	1
1803816	NCD 19 5/8AF	5/8	39.5	22.5	23.8	15.0	73	1
1803824	NCD 19 11/16AF	11/16	39.5	24.7	22.5	17.0	66	1
1803832	NCD 19 3/4AF	3/4	40.0	26.7	24.5	17.0	84	1

COROSTOP NC SCREWDRIVER

NC 42

HEXAGON SOCKET KEY NC for in-hex screws METRIC

- Acc. to DIN ISO 2936
- GEDORE vanadium plus steel with COROSTOP coating

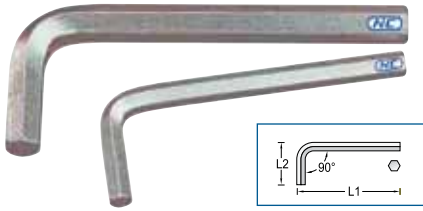

mm

Code	No.	mm	L ₁	L ₂	↔	📦
1670077	NC 42 1,3	1.3	41.0	13.0	1	1
1670093	NC 42 1,5	1.5	46.5	15.5	1	1
1670107	NC 42 2 (5/64AF)	2.0	52.0	18.0	2	1
1670115	NC 42 2,5	2.5	58.5	20.5	2	1
1670123	NC 42 3	3.0	66.0	23.0	4	1
1670131	NC 42 4	4.0	74.0	29.0	10	1
1670158	NC 42 5	5.0	85.0	33.0	18	1
1670174	NC 42 6	6.0	96.0	38.0	30	1
1670182	NC 42 8	8.0	108.0	44.0	58	1
1670190	NC 42 10	10.0	122.0	50.0	104	1

"AF"

Code	No.	"AF"	L ₁	L ₂	↔	📦
1884158	NC 42 3/32AF	3/32	56.5	20.5	3	1
1884166	NC 42 1/8AF	1/8	60.0	23.0	5	1
1884174	NC 42 5/32AF	5/32	67.0	26.0	8	1
1884182	NC 42 3/16AF	3/16	73.0	30.0	15	1
1884190	NC 42 7/32AF (5,5MM)	7/32	82.0	32.0	20	1
1803956	NC 42 1/4AF	1/4	92.0	36.5	32	1
1803964	NC 42 5/16AF	5/16	102.0	43.0	56	1
1803972	NC 42 3/8AF	3/8	115.0	49.0	88	1
1803980	NC 42 1/2AF	1/2	142.0	61.0	196	1
1803999	NC 42 9/16AF	9/16	154.0	66.0	264	1
1804006	NC 42 5/8AF	5/8	168.0	76.0	366	1
1804014	NC 42 3/4AF	3/4	199.0	89.0	600	1

NCH 42-10

HEXAGON SOCKET KEY SET NC for in-hex screws

- In blue PVC wallet
- GEDORE vanadium plus steel with COROSTOP coating



mm

Code	No.	Contents	↔	📦
1689541	NCH 42-10	● 1,3 1,5 2 2,5 3 4 5 6 8 10	262	1

NC H 42-88 A

HEXAGON SOCKET KEY SET NC for in-hex screws

- In blue PVC wallet
- GEDORE vanadium plus steel with COROSTOP coating

"AF"

Code	No.	Contents	↔	📦
1884131	NC H 42-88 A	● 5/64 3/32 1/8 5/32 3/16 7/32 1/4 5/16"	171	1



NC SCL 43 TX-80

HEXAGON SOCKET KEY SET NC for recessed TORX® screws

- In robust metal clip
- GEDORE vanadium plus steel with COROSTOP coating
- TORX® = reg. trademark of Acument Intellectual Properties, LLC. USA



Code	No.	Contents	↔	📦
1670026	NC SCL 43 TX-80	● T9 T10 T15 T20 T25 T27 T30 T40	286	1

NC 2150

3C-SCREWDRIVER NC for slotted head screws

- Acc. to DIN ISO 2380-2, blade tip DIN ISO 2380-1 Form A
- 3-component handle with hanging hole
- Blade in vanadium plus steel with COROSTOP coating



Code	No.	mm	mm	Ø	mm	mm	mm	📦
1669893	NC 2150 3	0.5	3.0	3	80	160	26	1
1669907	NC 2150 5,5	1.0	5.5	5	125	225	70	1
1669915	NC 2150 8	1.2	8.0	7	175	295	136	1

NC 2160 PH

3C-SCREWDRIVER NC for cross-slotted head screws PH

- Acc. to DIN 8764, tip to DIN ISO 8764-1 PH
- 3-component handle with hanging hole
- Blade in vanadium plus steel with COROSTOP coating



Code	No.	PH	M	Ø	mm	mm	mm	📦
1884417	NC 2160 PH 0	0	M1,6 - M2	3,0	60	140	25	1
1669923	NC 2160 PH 1	1	M2 - M3	4,5	80	180	60	1
1669931	NC 2160 PH 2	2	M3,5 - M5	6,0	100	210	90	1



COROSTOP NC PLIERS

NC 137

GRIP WRENCH NC

- With adjustment screw and release lever
- Forged, hardened and tempered jaws, special jaw shape for secure gripping, clamping and holding
- GEDORE vanadium steel 31CrV3, with COROSTOP coating



Code	No.	L [mm]	L ₃ [mm]	W ₃ [mm]	W ₄ [mm]	T ₁ [mm]	T ₂ [mm]	Weight [kg]	Material
1670050	NC 137 10	240	10	32	1/32	506	1		

NC 145

WATER PUMP PLIERS NC

- 7-way adjustable
- Acc. to DIN ISO 8976, Form A
- Lay-on slip joint and toothed recess
- Induction-rehardened serrated faces, with finger protection
- GEDORE vanadium steel 31CrV3, with COROSTOP coating

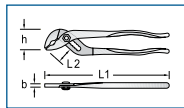

Code	No.	L ₁ [mm]	L ₂ [mm]	b [mm]	h [mm]	mm [mm]	Weight [kg]	Material
1670069	NC 145 10	250	41	7.8	47	39	398	1

NC 8132

TELEPHONE PLIERS NC

- Acc. to DIN ISO 5745
- Flat-round jaws, straight gripping faces, serrated
- Induction-hardened precision cutting edges
- GEDORE special hardened and tempered steel, with COROSTOP coating

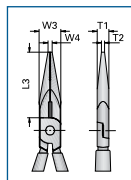

Code	No.	L	L ₃	W ₃	W ₄	T ₁	T ₂	Weight [kg]	Material
1669982	NC 8132-160 J	160	50	16.5	3.2	9	2.5	150	1

NC 8132 AB

BENT NOSE TELEPHONE PLIERS NC

- Similar to DIN ISO 5745
- Flat-round jaws, angled gripping faces, serrated
- Induction-hardened precision cutting edges
- GEDORE special hardened and tempered steel, with COROSTOP coating

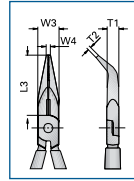

Code	No.	L	L ₃	W ₃	W ₄	T ₁	T ₂	Weight [kg]	Material
1884123	NC 8132 AB-160 J	160	46	16.5	3.2	9	2.5	140	1

NC 8210

COMBINATION PLIERS NC German pattern

- Acc. to DIN ISO 5746
- Lay-on cutter box
- For medium-hard and hard wire
- Induction-hardened precision cutting edges
- GEDORE special hardened and tempered steel, with COROSTOP coating

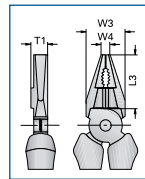

Code	No.	L	L ₃	W ₃	W ₄	T ₁	Weight [kg]	Material
1669966	NC 8210-180 J	180	38	27	6.4	11.8	266	1

NC 8316

POWER SIDE CUTTER NC American pattern

- Acc. to DIN ISO 5749
- For hard wire, including piano wire
- Induction-hardened precision cutting edges, hardness 63-65 HRC
- GEDORE special hardened and tempered steel, with COROSTOP coating

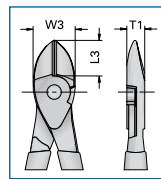

Code	No.	L	L ₃	W ₃	T ₁	∅	Weight [kg]	Material
1669974	NC 8316-160 J	160	19	24.5	10	1.6	218	1

COROSTOP NC PULLER

NC 1.04

PULLER NC 2-arm pattern

- ✔ COROSTOP coating protects against corrosion
- ✔ Cross-beam reinforces bending moment
- ✔ Cantilever hook enhances power
- ✔ Quick-release legs
- ✔ Spindle with replaceable ball and tip point
- ✔ Spindle thermo-chemically hardened
- ✔ Upgradeable with hydraulic spindle (see table)

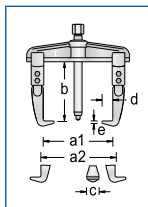

Code	No.	a ₁	a _{2 min}	a _{2 max}	b	⌀	⌀ mm	c	d	e	max. t	↕	⊞	
1829521	NC 1.04/1A	130	70	170	100	M 14x1,5 x 140		17	22	15	3.0	3.0	1.2	1
1829548	NC 1.04/2A	200	110	260	150	G 1/2 x 210	1.06/HSP1	22	30	25	4.5	5.0	3.4	1
1829556	NC 1.04/3A	350	150	420	200	G 3/4 x 280	1.06/HSP2	27	36	33	6.0	7.5	8.7	1

COROSTOP NC PARTS

NC 49

SPARK PLUG SOCKET WRENCH NC

- ✔ With rubber spark-plug gripper and offset bores
- ✔ Forged and hardened
- ✔ With angled tommy bar no. 49 D Ø 8 mm
- ✔ With COROSTOP coating

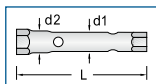

Code	No.	⌀ mm	⌀ AF	L	d ₁	d ₂	↕	⊞
1669990	NC 49 R	16 x 20,8	5/8 x 13/16	190	24	25	256	1
1670018	NC 49 D			175	8		70	1

NC 97

FLAT COLD CHISEL NC octagonal

- ✔ GEDORE chrome-molybdenum-vanadium steel 45CrMoV7, with COROSTOP coating

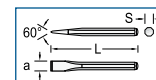

Code	No.	L	a	s mm	↕	⊞
1670034	NC 97-150	150	16	12	126	1

NC 119

PIN PUNCH NC octagonal

- ✔ Acc. to DIN 6450, Form C
- ✔ GEDORE chrome-molybdenum-vanadium steel 59CrV4K, with COROSTOP coating

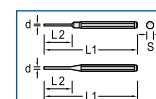

Code	No.	L ₁ mm	L ₂	d mm	s mm	↕	⊞
1670042	NC 119-4	150	50	4	10	64	1

ACCESSORIES

4900

WEATHER PROOF MULTI TOOL for NAUTIC-Sets 502+503

- ✔ Multi-tool, includes:
 - ✔ Variable open ended spanner 10-19 mm
 - ✔ Mechanic's pliers
 - ✔ Knife
 - ✔ Saw with file and screwdriver blade
 - ✔ Screwdriver cruciform head size PH 1
- ✔ Delivery in wallet



Code	No.	↕	⊞
1669532	4900	308	1

NC 50 - NC 54

SPARK PLUG SOCKET NC

- ✔ With retention spring
- ✔ For use with socket drivers with 3/8" or 1/2" square drive or Ø 8 mm tommy bar
- ✔ GEDORE vanadium steel 31CrV3, with COROSTOP coating

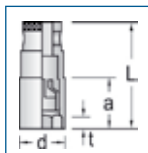

Code	No.	⌀ mm	⌀ AF	□"	L	a	t	d	↕	⊞
1669869	NC 50	20.8	13/16	1/2	63.5	25.5	7	27.5	128	1
1670204	NC 52	20.8	13/16	3/8	63.5	25.5	7	27.5	140	1
1670212	NC 53	16.0	5/8	3/8	63.5	20.5	7	21.5	96	1
1669885	NC 54	16.0	5/8	1/2	63.5	20.5	7	21.5	92	1

NC 59 GK

GLOW PLUG SOCKET NC 3/8"

- ✔ For diesel engines
- ✔ With COROSTOP coating

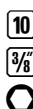

Code	No.	⌀ mm	□"	L	a ₁	↕	⊞
2000288	NC 59 GK 10x70	10	3/8	70	30	70	1



COROSTOP TOOL SETS

Tools in metric or inch sizes. Supplied in watertight, offshore-yellow cases, temperature-stable from -25°C to +80°C. The cases float and can give a person overboard additional buoyancy. Depending on its size, the case complete with tools has a buoyancy of around 10 N - 100 N. The majority of the tools have the special COROSTOP (= NC) coating to give long-term corrosion-proofing.



NC SET METRIC

502 M

NAUTIC SET DHINGY 11 pieces

- ✔ This set contains the basic tools required on a small sailing boat
- ✔ In watertight, offshore-yellow cases, dimensions: 255 x 180 x 80 mm
- ✔ The buoyancy of the case including tools is more than 20 N
- ✔ Temperature resistant from -25° to 80°C
- ✔ First-Aid-Kit in lid
- ✔ Delivery package does not contain any extras (glasses, watch, mobile phone etc.)



mm

502 P

NAUTIC SET DHINGY PLUS 17 pieces

- ✔ This set contains only the tools required on a small sailing boat
- ✔ In watertight, offshore-yellow cases, dimensions: 255 x 180 x 80 mm
- ✔ The buoyancy of the case including tools is more than 20 N
- ✔ Temperature resistant from -25° to 80°C
- ✔ First-Aid-Kit in lid



mm

Code	No.	Contents	Buoyancy N	🚚	📦
1657453	502 M	NC 42 2,5 4 5 6 8 NC 2150 5,5 NC 2160 PH 2 NC 8210-180 J 4900 E-502/503 EH First-Aid-Kit E-502 P Plastic box	20	1.7	1

Code	No.	Contents	Buoyancy N	🚚	📦
1884395	502 P	NC H 42-10 (1,3 1,5 2 2,5 3 4 5 6 8 10 mm) 4900 NC 145 10 NC 2160 PH 0 1 2 247 H-30-200 E-502/503 EH First-Aid-Kit	20	1.7	1







503 M

NAUTIC SET MOTORBOAT 22 pieces

- ▶ The MOTORBOAT set is aimed at skippers of small to medium-sized motorboats
- ▶ It contains all the tools required to carry out maintenance and minor engine repairs
- ▶ In watertight, offshore-yellow cases, dimensions: 255 x 180 x 80 mm
- ▶ The buoyancy of the case including tools is more than 10 N
- ▶ Temperature resistant from -25° to 80°C
- ▶ First-Aid-Kit in lid



 mm

Code	No.	Contents	Buoyancy N		
1657461	503 M	NC 42-10 (1,3 1,5 2 2,5 3 4 10) 5 6 8 10) NC 49 D, NC 49 R NC 145 10 NC 2150 5,5 NC 2160 PH 2 NC 8210-180 J 4900 648 4610 4629 8729 E-502/503 EH First-Aid-Kit	2,6		1

504 M



NAUTIC SET YACHT 65 pieces

- ▶ The YACHT set is aimed at skippers of large motor and sailing yachts, enabling them to carry out repairs away from the marina
- ▶ In watertight, offshore-yellow cases, dimensions: 380 x 250 x 120 mm
- ▶ The buoyancy of the case including tools is around 100 N
- ▶ Temperature resistant from -25° to 80°C

 10
 3/8



 mm

Code	No.	Contents	Buoyancy N		
1658344	504 M	NC 7 6 7 8 9 10 12 13 14 15 16 17 18 19 NC H 42-10 (1,3 1,5 2 2,5 3 4 5 6 8 10) NC SCL 43 TX-80 (T9 T10 T15 T20 T25 T27 T30 T40) NC 52 NC 53 NC 60 P 8 NC 30 8 10 12 13 14 15 16 17 18 19 20 21 22 NC 3087 NC 3090-5 NC 3093 U-10 NC 137 10 NC 2150 3 5,5 8 NC 2160 PH 1 2 406 4522 4534-3 4610 4629 NC 8132-160 J NC 8210-180 J NC 8316-160 J 247 H-30	100		1

505 M



NAUTIC SET CARGO SHIP 73 pieces

- ▶ The CARGO SHIP set is aimed at skippers of vessels from small fishing smacks up to cargo ships, enabling them to carry out repairs out of port
- ▶ In watertight, offshore-yellow cases, dimensions: 420 x 305 x 170 mm
- ▶ The buoyancy of the case including tools is around 100 N
- ▶ Temperature resistant from -25° to 80°C

 12,5
 1/2



 mm

Code	No.	Contents	Buoyancy N			
1658336	505 M	NC 7 6 7 8 9 10 12 13 14 16 17 18 19 22 24 27 30 32 NC H 42-10 (1,3 1,5 2 2,5 3 4 5 6 8 10) NC SCL 43 TX-80 (T9 T10 T15 T20 T25 T27 T30 T40) NC 50 NC 54 NC 19 10 12 13 14 16 17 18 19 22 24 27 30 32 NC 1987 NC 1990-5 -10 NC 1993 U-10 T NC 60 P 12 NC 137 10 NC 145 10 NC 352 150 NC 355 4 NC 2150 3 5,5 8 NC 2160 PH 1 2 406 4522 4534-3 4610 4629 NC 8132-160 J NC 8210-180 J NC 8316-160 J 247 H-30	100		13,5	1



NC SET INCH

504 A

NAUTIC SET YACHT AF 58 pieces

- The YACHT set is aimed at skippers of large motor and sailing yachts, enabling them to carry out repairs away from the marina
- Tools in inch sizes
- In watertight, offshore-yellow cases, dimensions: 380 x 250 x 120 mm
- The buoyancy of the case including tools is around 100 N
- Temperature resistant from -25° to 80°C

10
3/8"



AF

505 A

NAUTIC SET CARGO SHIP AF 64 pieces

- The CARGO SHIP set is aimed at skippers of vessels from small fishing smacks up to cargo ships, enabling them to carry out repairs out of port
- Tools in inch sizes
- In watertight, offshore-yellow cases, dimensions: 420 x 305 x 170 mm
- The buoyancy of the case including tools is around 100 N
- Temperature resistant from -25° to 80°C

12,5
1/2"



AF

Code	No.	Contents	Buoyancy N	Icon 1	Icon 2
1884239	504 A	NC 7 1/4 5/16 11/32 3/8 7/16 1/2 9/16 5/8 11/16 3/4" NC H 42-88 A (5/64 3/32 1/8 5/32 3/16 7/32 1/4 5/16") NC SCL 43 TX-80 (T9 T10 T15 T20 T25 T27 T30 T40) NC 52 NC 53 NC 60 P 8 NC 30 1/4 5/16 11/32 3/8" NC D 30 7/16 1/2 9/16 19/32 5/8 11/16 3/4" NC 3087 NC 3090-5 NC 3093 U-10 NC 137 10 NC 2150 3 5,5 8 NC 2160 PH 1 2 406 4522 4534-3 4610 4629 NC 8132 AB-160 J NC 8210-180 J NC 8316-160 J 247 H-30	100	6.5	1

Code	No.	Contents	Buoyancy N	Icon 1	Icon 2
1884220	505 A	NC 7 1/4 5/16 11/32 3/8 7/16 1/2 9/16 5/8 11/16 3/4 7/8 1" NC H 42-88 A (5/64 3/32 1/8 5/32 3/16 7/32 1/4 5/16") NC SCL 43 TX-80 (T9 T10 T15 T20 T25 T27 T30 T40) NC 50 NC 54 NC D 19 5/16 11/32 3/8 13/32 7/16 1/2 9/16 19/32 5/8 11/16 3/4" NC 1987 NC 1990-5 -10 NC 1993 U-10 T NC 60 P 12 NC 137 10 NC 145 10 NC 352 150 NC 355 4 NC 2150 3 5,5 8 NC 2160 PH 1 2 406 4522 4534-3 4610 4629 NC 8132 AB-160 J NC 8210-180 J NC 8316-160 J 247 H-30	100	10.0	1



More NC tools on request!
 Haven't you found the right tool?
 Ask us about custom-orders.
 Your problems are our assignments.



GEORE
8250-200
AUSTRIA



Schneide induktiv
gehärtet
Härte: 62-64HRC



VDE INSULATED SAFETY TOOLS



++ VDE SPECIAL PURPOSE USE

++ UP TO 1000 V



SERVICE / FEATURES		502 - 503
VDE SPANNERS		504
VDE TORQUE WRENCHES		504
VDE SOCKETS + ACCESSORIES		505
VDE SCREWDRIVER		506
VDE PLIERS		506 - 511
VDE ASSORTMENTS		511 - 514
VDE TOOL CABINET		513
VDE ACCESSORIES		514 - 515



Sheath-stripping, wire-stripping, crimping tools etc. can be found on pages 332 - 339

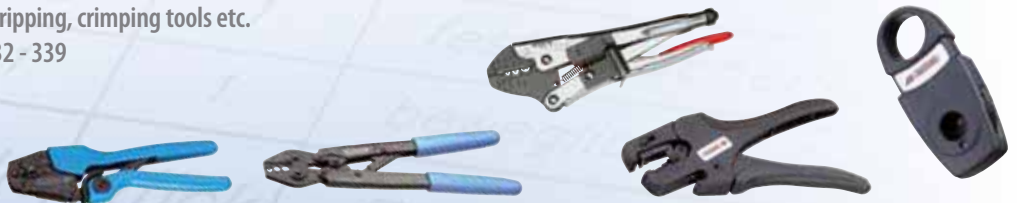

++ VDE INSULATED SAFETY TOOLS



- ▶ Only tools bearing this test mark are classed as insulated tools
- ▶ VDE insulation: insulated up to 1000 V acc. to EN 60900 / IEC 60900:2004
- ▶ Safe working in high-voltage areas
- ▶ Up to 1000 V AC (alternating current)
- ▶ Up to 1500 V DC (direct current)

 **1000 V**



- ▶ The GS symbol is a symbol defined in the law on technical equipment and consumer products (German Equipment and Product Safety Act/GSPG). It may only be used with the name given of the testing and certification office.



- ▶ The VDE symbol points to the VDE Test Institute as having carried out the test. As a result, GEDORE and the VDE Test Institute vouch for the fulfilment of the tool and safety standards and thus meet the requirements of the German equipment safety law.



- ▶ Tools marked with the double triangle are individually tested = testing at 10000 V AC based on EN 60900 / IEC 60900:2004



Note:

- ▶  and 1000 V particulars in association with the GEDORE log point to a tool tested and insulated by GEDORE.
- ▶ Texts: All DIN EN 60900-tested tools must be marked with the manufacturer's name, model or type designation, the year of manufacture and the double triangle lightning symbol with the 1000 V detail.

VDE REGULATIONS / TEST SPECIFICATIONS

- ▶ All GEDORE VDE safety tools - given their proper use - are manufactured to dependably protect the user from any electrical shock currents.
- ▶ For this to be ensured, major testing steps up to a 100% testing of the electrical insulating property at the 10000 V high-voltage test facility are prescribed.
- ▶ With the test passed, GEDORE VDE-tools then have a 10-fold safety from electrical shock currents and are approved of for working under voltages up to AC 1000 V and DC 1500.
- ▶ For these properties to be realized a host of requirements must be adhered to. They are listed in DIN EN 60900:2004. They include:



Note:

- ▶ All mechanical requirements such as hardness, torque and forces must comply with the DIN-ISO tolerances.
- ▶ To ensure the high safety standard of the insulated GEDORE VDE tools, independent, authorised testing centres, such as the VDE association, carry out both type examinations as well as manufacturing and storage inspections.



Voltage test
- No electric breakdown
- Leakage current below the norm
- No electric flashover

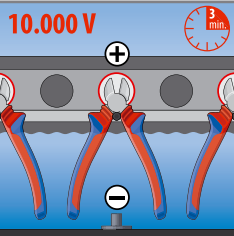

Shock test
- No flaking
- No cracks
- No fractures

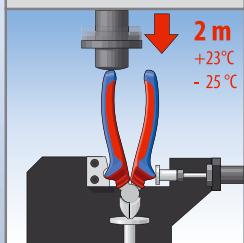

Bonding test
- No detaching of the insulation

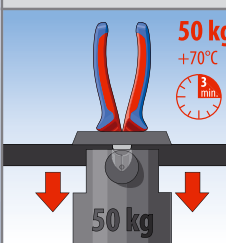

Penetration test
- No electric flashover
- No electric breakdown
- No detaching of the insulation

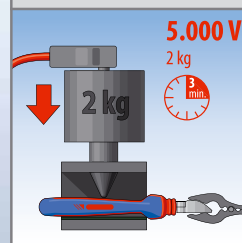

Burning behavior test
- Flame height below the norm

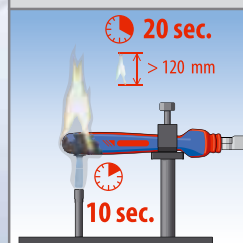



+ VDE CHECK-TOOL INSULATION ++



1000

Only tools with this test mark are considered to be fully safe.

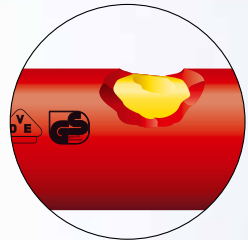

- All GEDORE VDE soft-plastic insulated safety tools have the Check-Tool insulation.
- The two-colour multi-layer insulation - red on the outside, yellow on the inside - complies with the BGV A3 (VBG-4) regulation.
- The tool must not show any discernable damage.
- For technical reasons, Check-Tool insulation cannot be applied on tools with sprayed insulation.

The two-ply Check-Tool insulation

SAFETY NOTES

- Work on electrically live equipment must be carried out only by trained electricians!
- Only tools and safety equipment marked with the double triangle or bell 1000 V symbol (refer to BGV A3) must be used.
- Before commencing any work, check the insulation for damage.
- Damaged tools must not be used!
- The regulations of the employers' liability insurance associations and power supply companies must be complied with!
- GEDORE VDE tools are approved for work on live circuits at voltages up to 1000 V AC and 1500 V DC.
- Tools must not be combined unless they are designed to be securely joined together.

VDE ACCESSORIES

Some items in our VDE accessories range are marked with the usual test mark for protective equipment.



VDE SPANNERS

VDE 2 E

VDE SINGLE ENDED RING SPANNER deep offset

- GEDORE vanadium steel 31CrV3
- With VDE insulation as per EN 60900 / IEC 60900:2004, two-ply Check-Tool insulation



Code	No.	Ø mm	l mm	l ₁ mm	l ₂ mm	l ₃ mm
6035890	VDE 2 E 8	8	170	61	1	1
6035970	VDE 2 E 9	9	170	74	1	1
6036000	VDE 2 E 10	10	170	97	1	1
6036190	VDE 2 E 11	11	180	93	1	1
6036270	VDE 2 E 12	12	190	147	1	1
6036350	VDE 2 E 13	13	190	130	1	1
6036430	VDE 2 E 14	14	210	151	1	1
6036510	VDE 2 E 15	15	215	155	1	1
6036780	VDE 2 E 17	17	220	199	1	1
6036860	VDE 2 E 19	19	240	244	1	1
6036940	VDE 2 E 22	22	260	319	1	1
6037080	VDE 2 E 24	24	280	446	1	1
6037160	VDE 2 E 27	27	295	506	1	1
6037240	VDE 2 E 30	30	310	592	1	1
6037320	VDE 2 E 32	32	330	683	1	1

VDE 894

VDE SINGLE OPEN ENDED SPANNER

- GEDORE vanadium steel 31CrV3
- With VDE insulation as per EN 60900 / IEC 60900:2004
- Jaw set at 15°



Code	No.	Ø mm	l mm	l ₁ mm	l ₂ mm
6572040	VDE 894 9	9	105	30	1
6572120	VDE 894 10	10	105	34	1
6572200	VDE 894 11	11	115	44	1
6572390	VDE 894 12	12	125	52	1
6572470	VDE 894 13	13	135	67	1
6572550	VDE 894 14	14	145	81	1
6572630	VDE 894 15	15	150	93	1
6572710	VDE 894 16	16	155	108	1
6572980	VDE 894 17	17	160	117	1
6573010	VDE 894 19	19	175	161	1
6573280	VDE 894 22	22	200	210	1
6573360	VDE 894 24	24	220	268	1
6573440	VDE 894 27	27	245	396	1
6573520	VDE 894 30	30	265	486	1
6574920	VDE 894 32	32	280	558	1

V 60 CP

ADJUSTABLE WRENCH open end, 1000 V

- Chrome-plated
- Dip-insulated up to 1000 V
- Not certified acc. to VDE



1000 V

Code	No.	Size "	mm	l mm	l ₁ mm
2179040	V 60 CP 6	6	20	170	1
2179059	V 60 CP 8	8	25	330	1
2179067	V 60 CP 10	10	30	520	1
2179075	V 60 CP 12	12	36	880	1

VDE 2133

VDE SOCKET WRENCH with 3C-handle

- With hanging hole
- Head depth 25 mm, blade length 125 mm
- GEDORE vanadium steel 31CrV3
- With VDE insulation up to 1000 V, as per EN 60900 / IEC 60900:2004



Code	No.	Ø mm	l mm	l ₁ mm	Head Ø	l ₂ mm	l ₃ mm
1747045	VDE 2133 3	3	125	225	9	95	1
1747053	VDE 2133 4	4	125	225	10	97	1
1747061	VDE 2133 5	5	125	225	11	98	1
1747088	VDE 2133 6	6	125	225	12	100	1
1747096	VDE 2133 7	7	125	235	14	134	1
1747118	VDE 2133 8	8	125	235	15	136	1
1747126	VDE 2133 9	9	125	235	16	136	1
1747134	VDE 2133 10	10	125	235	17	143	1
1747142	VDE 2133 11	11	125	245	19	173	1
1747150	VDE 2133 12	12	125	245	20	176	1
1747169	VDE 2133 13	13	125	245	21	179	1
1747177	VDE 2133 14	14	125	245	22	178	1
1747185	VDE 2133 17	17	125	245	26	202	1

VDE TORQUE WRENCHES

VDE 4507

VDE TORQUE WRENCH 1/2" 5-50 N-m / 4-37 lbf-ft

- Automatic short-way release and acoustic signal
- Manually adjustable dual scale with metric and SAE values
- Fine toothed ratchet with square drive as per DIN 3120 - A 12.5, ISO 1174
- With VDE insulation as per EN 60900 / IEC 60900:2004, two-ply Check-Tool insulation



Code	No.	Size "	mm	l mm	l ₁ mm	l ₂ mm
6681920	VDE 4507-4	1/2	12.5	370	1251	1



VDE SOCKETS + ACCESSORIES

VDE 19

VDE SOCKET 1/2"

- Hexagon socket wrench, hand-operated
- With square drive according to DIN 3120 - C 12.5, ISO 1174
- GEDORE vanadium steel 31CrV3
- With VDE insulation as per EN 60900 / IEC 60900:2004, two-ply Check-Tool insulation
- 10-12 mm insulation overhang must be added to the lengths stated
- Sizes 27, 30 and 32: diameter d_1 is not standardised

12.5

1/2"

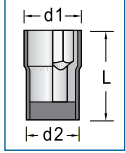

Code	No.	Ø mm	d_1	d_2	L	↕	☒
6122510	VDE 19 10	10	19.5	27	54.0	70	1
6122780	VDE 19 11	11	20.7	27	54.0	67	1
6122860	VDE 19 12	12	22.0	27	54.0	70	1
6122940	VDE 19 13	13	23.2	27	54.0	69	1
6123080	VDE 19 14	14	24.5	27	54.0	73	1
6123160	VDE 19 15	15	25.7	27	55.5	88	1
1439294	VDE 19 16	16	27.0	27	55.5	86	1
6123240	VDE 19 17	17	28.2	27	55.5	84	1
6123320	VDE 19 19	19	30.7	27	56.0	92	1
6123400	VDE 19 22	22	34.5	27	57.5	121	1
6123590	VDE 19 24	24	37.0	27	57.5	146	1
6123670	VDE 19 27	27	40.7	27	57.5	174	1
6123750	VDE 19 30	30	44.5	27	59.0	212	1
6123830	VDE 19 32	32	47.0	27	60.5	250	1

VDE IN 19

VDE SCREWDRIVER BIT SOCKET 1/2" for in-hex screws

- With pressed-in pin
- With square drive according to DIN 3120 - C 12.5, with ball groove
- Tips GEDORE vanadium special steel
- With VDE insulation as per EN 60900 / IEC 60900:2004, two-ply Check-Tool insulation
- Sockets can only be combined with VDE 1989 T, VDE 1991, VDE 1993 U and VDE 4507

12.5

1/2"



Code	No.	Ø mm	↳ mm	Ø	↕	☒
6124480	VDE IN 19 5	5	106	27	83	1
6124560	VDE IN 19 6	6	106	27	95	1
6124640	VDE IN 19 8	8	106	27	109	1

VDE 1990

VDE EXTENSION 1/2"

- For hand-operated sockets with square drive as per DIN 3120, ISO 1174
- With lock screw for holding the socket wrenches
- With VDE insulation as per EN 60900 / IEC 60900:2004, two-ply Check-Tool insulation
- Not suited for use with VDE IN 19
- 10-12 mm insulation overhang must be added to the lengths stated

12.5

1/2"



Code	No.	■"	■	↳ mm	↕	☒
6124050	VDE 1990-5	1/2	12.5	125	213	1
6124130	VDE 1990-10	1/2	12.5	250	411	1

VDE 1991

VDE EXTENSION 1/2"

- With hollow shaft, especially suitable for screwdriver bit sockets VDE IN 19
- Max. torque 370 N-m
- With VDE insulation as per EN 60900 / IEC 60900:2004, two-ply Check-Tool insulation

12.5

1/2"



Code	No.	■"	■	↳ mm	↕	☒
1507516	VDE 1991	1/2	12.5	125	204	5

VDE 1988 - VDE 1989 T

VDE T-HANDLE for 1/2" VDE tools

- With VDE insulation as per EN 60900 / IEC 60900:2004, two-ply Check-Tool insulation
- VDE 1988 with screw locking, not suited for use with VDE IN 19
- VDE 1989 T with pull locking

12.5

1/2"



Code	No.	■"	■	↳ mm	↕	☒
6124210	VDE 1988	1/2	12.5	200	455	1
6124720	VDE 1989 T	1/2	12.5	200	355	1

VDE 1993 U

VDE REVERSIBLE RATCHET 1/2" with push-button release

- Robust, with smooth action
- Sockets held absolutely securely by push-button lock with ball in the square drive
- Direction changed by 2 push-buttons, marked R and L, on the shaft
- Square drive acc. to DIN 3120 - A 12.5, ISO 1174, chrome-vanadium steel 31CrV3
- With VDE insulation acc. to EN 60900 / IEC 60900:2004

12.5

1/2"



Code	No.	■"	■	↳ mm	↕	☒
6123910	VDE 1993 U	1/2	12.5	270	546	1

VDE 42

VDE HEXAGON ALLEN KEY for in-hex screws

- Acc. to DIN ISO 2936
- Particularly suitable for cable branch clamping rings
- Oil-hardened
- GEDORE vanadium special steel
- With VDE insulation up to 1000 V, as per EN 60900 / IEC 60900:2004

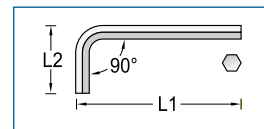

1000 V



Code	No.	● mm	L ₁	L ₂	↕	☒
2324849	VDE 42 3	3	130	23.5		1
2324857	VDE 42 4	4	120	40.0		1
2324865	VDE 42 5	5	140	48.0		1
2324873	VDE 42 6	6	140	48.0		1
2324881	VDE 42 8	8	150	51.0		1
2324903	VDE 42 10	10	220	51.0		1
2324911	VDE 42 12	12	260	61.5		1

VDE SCREWDRIVER

VDE 2170

VDE SCREWDRIVER for slotted head screws

- With VDE insulation as per EN 60900 / IEC 60900:2004, fully insulated blade
- Blade tip to DIN ISO 2380-1 form A
- With impact resistant handle
- Blade in chrome-vanadium steel, with black tip



Code	No.	mm±	mm±	mm	mm	mm	mm
1612220	VDE 2170 2,5	0.4	2.5	75	155	29	10
1612239	VDE 2170 3	0.5	3.0	100	180	33	10
1612247	VDE 2170 3,5	0.6	3.5	100	190	46	10
1612255	VDE 2170 4	0.8	4.0	100	190	49	10
1612271	VDE 2170 5,5	1.0	5.5	125	225	81	10
1612298	VDE 2170 6,5	1.2	6.5	150	260	116	10
1612301	VDE 2170 8	1.2	8.0	175	195	158	10
1612336	VDE 2170 10	1.6	10.0	200	320	188	10

VDE 2160 PH

VDE SCREWDRIVER for cross-slotted head screws PH

- With VDE insulation as per EN 60900 / IEC 60900:2004, fully insulated blade
- Blade tip to DIN ISO 8764-1 PH
- With impact-resistant handle
- Blade in chrome-vanadium steel, with black tip



Code	No.	PH	mm	mm	mm	mm
1612107	VDE 2160 PH 0	0	M1,6 - M2	60	140	30
1612115	VDE 2160 PH 1	1	M2 - M3	80	180	68
1612123	VDE 2160 PH 2	2	M3,5 - M5	100	210	101
1612131	VDE 2160 PH 3	3	M5,5 - M7	150	270	168
1612158	VDE 2160 PH 4	4	M8 - M10	200	320	249

VDE 2160 PZ

VDE SCREWDRIVER for cross-slotted head screws PZ

- With VDE insulation as per EN 60900 / IEC 60900:2004, fully insulated blade
- Blade tip to DIN ISO 8764-1 PZ
- With impact-resistant handle
- Blade in chrome-vanadium steel, with black tip



Code	No.	PZ	mm	mm	mm	mm
1612166	VDE 2160 PZ 0	0	M1,6 - M2	60	140	29
1612182	VDE 2160 PZ 1	1	M2 - M3	80	180	68
1612190	VDE 2160 PZ 2	2	M3,5 - M5	100	210	102
1612204	VDE 2160 PZ 3	3	M5,5 - M7	150	270	168
1612212	VDE 2160 PZ 4	4	M8 - M10	200	320	250

VDE 2170-2160 PH-077

VDE SCREWDRIVER SET 7 pieces

- Packed in environmentally-friendly cardboard box
- For slotted and cross-slotted head screws PH
- With VDE insulation as per EN 60900 / IEC 60900:2004, fully insulated blade
- With impact-resistant handle



Code	No.	Contents	mm	mm
1616048	VDE 2170-2160 PH-077	⊖ VDE 2170 2,5 4 5,5 6,5 ⊕ VDE 2160 PH 0 1 2	575	1

V 4614 PLUS

VOLTAGE TESTER 1000 V two-pole with LED display

- For 6-1000 V AC
- Optical warning of life-threatening voltage above 35 V
- Acoustic and visual continuity testing from 0 to 500 kΩ
- Phase testing > 100 V AC
- Phase sequence indicator
- RCD triggering by automatic load function, Is~30mA, ED (DT) = max. 30 sec.
- Safety outlet and CEE one-hand operation
- Removable 4 mm tip adaptor
- Undetachable test tip protection
- Protection classification IP65, dust-proof, hose-proof
- Integrated LED torch (white)
- 2x batteries type AAA Micro
- Automatic on/off function
- CAT IV 1000 V
- TÜV/GS tested and approved, IEC/EN 61243-3, DIN VDE 0682 Part 401

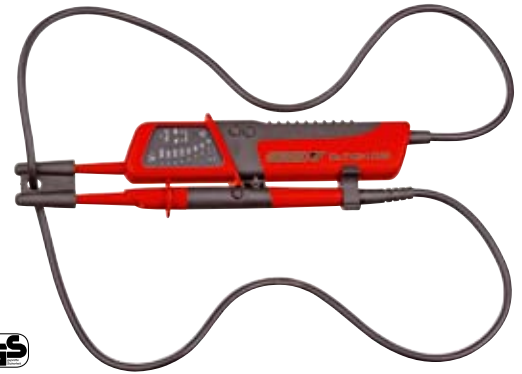

Code	No.	mm	mm
2241137	V 4614 PLUS	270	1

VDE PLIERS

180

CABLE SHEARS

- Cuts cable up to 27 mm, solid material up to 200 mm²
- Not certified acc. to VDE



Code	No.	mm	mm
6430330	180 23	620	2125

V 8091

CABLE CUTTER

- For cutting copper and aluminium cables
- Genuine single-hand operation, with optimum transfer of force. Handles ergonomically designed for fatigue-free constant use. Little hand pressure required even at maximum loading. For step-by-step cutting with burr-free cut, may be opened in every cutting position. With locking lever.
- Tool body in high-tensile special steel
- Cutting edges and important functional parts tempered or specially hardened
- Red plastic handles insulated
- Suitable for use up to 1000 V
- Not certified acc. to VDE
- V 8091-320: single-strand cable, max. Ø 25 mm (1"), multi-strand cable, max. Ø 32 mm (1.1/4")
- V 8091-500: multi-strand cable, max. Ø 52 mm (2.1/32")



Code	No.	mm	mm
6725130	V 8091-320	280	792
6725210	V 8091-500	280	999



VDE 8094

VDE CABLE SHEARS with VDE dipped insulation

- For cutting multi-strand copper and aluminium cables up to Ø 20 mm
- Up to Ø 25 mm with first and second cut
- Cutting edges additionally inductively hardened
- Precision ground for a clean and new cutting-edge geometry
- With adjustable screw joint and finger protection
- Not suitable for steel wire or hard-drawn copper wire
- Special tool steel, forged, gun-metal finish
- Handles with VDE insulation as per EN 60900 / IEC 60900:2004, two-ply Check-Tool insulation



Code	No.	Ø	Cable cross section	↳mm↳	↳inch↳	↕	☒
6725050	VDE 8094	20	70	200	8.1/2	423	1

VDE 8099

VDE STRIPPING PLIERS STRIP-FIX with VDE dipped insulation

- Self-adjusting, for wires 0.5-5.0 mm²
- GEDORE special hardened and tempered steel, oil-hardened, chrome-plated
- Handles with VDE dipped insulation as per EN 60900 / IEC 60900:2004, two-ply Check-Tool insulation
- E-8099 = Pair of spare knives



Code	No.	↳mm↳	↳inch↳	Cable cross section	↕	☒
6709600	VDE 8099-160	160	6.1/2	0,5-5	226	1
5709580	E-8099				12	1

VDE 8098

VDE STRIPPING PLIERS with VDE dipped insulation

- Opening stop, spring and brass adjusting screw for wires 0.8 - 6.0 mm²
- GEDORE special hardened and tempered steel, chrome-plated
- Handles with VDE dipped insulation as per EN 60900 / IEC 60900:2004, two-ply Check-Tool insulation

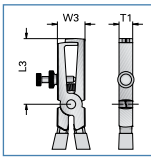

Code	No.	L	L ₃	W ₃	T ₁	Cable cross section	↕	☒
6708980	VDE 8098-160	160	43.5	18.5	8.5	0,8-6	217	1

VDE 8099 H

VDE STRIPPING PLIERS STRIP-FIX with VDE insulating sleeves

- Self-adjusting, for wires 0.5-5.0 mm²
- GEDORE special hardened and tempered steel, oil-hardened, chrome-plated
- Handles with VDE insulating sleeves as per EN 60900 / IEC 60900:2004



Code	No.	↳mm↳	↳inch↳	Cable cross section	↕	☒
1552082	VDE 8099-160 H	160	6.1/2	0,5-5	211	1

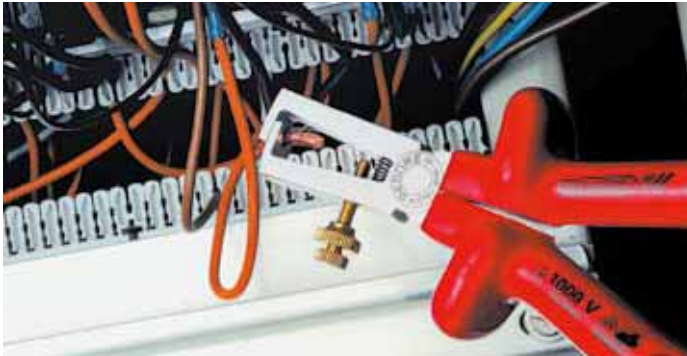

VDE 8098 H

VDE STRIPPING PLIERS with VDE insulating sleeves

- Opening stop, spring and brass adjusting screw for wires 0.8 - 6.0 mm²
- GEDORE special hardened and tempered steel, chrome-plated
- Handles with VDE insulating sleeves as per EN 60900 / IEC 60900:2004

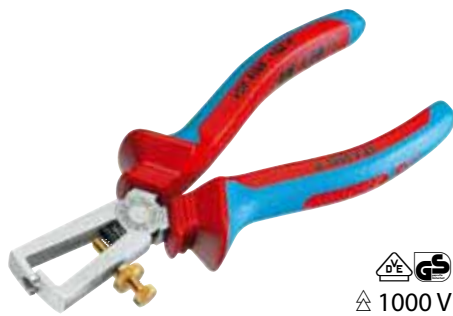
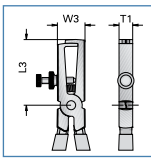

Code	No.	L	L ₃	W ₃	T ₁	Cable cross section	↕	☒
1552074	VDE 8098-160 H	160	43.5	18.5	8.5	0,8-6	204	1

VDE 146

VDE UNIVERSAL PLIERS 7 settings

- Gripping pliers with safety box joint and finger protection
- GEDORE special chrome-vanadium steel
- Handles with VDE dipped insulation as per EN 60900 / IEC 60900:2004, two-ply Check-Tool insulation



Code	No.	↳mm↳	mm☐	↕	☒
6120140	VDE 146 10	250	31	485	1



VDE 8250

VDE HEAVY DUTY COMBINATION PLIERS with VDE dipped insulation

- Induction-hardened precision cutting edges, hardness 62-64 HRC, for all wire types
- For heavy continuous use
- GEDORE special hardened and tempered steel, chrome-plated
- Handles with VDE dipped insulation as per EN 60900 / IEC 60900:2004, two-ply Check-Tool insulation

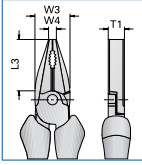

Code	No.	L	L ₃	W ₃	W ₄	T ₁	∅	↕	⊞
1429582	VDE 8250-160	160	35.0	22.8	5.8	10.4	236	1	
6720090	VDE 8250-180	180	38.5	25.6	6.5	11.0	312	1	
6720250	VDE 8250-200	200	39.5	27.0	6.5	12.4	365	1	
6720330	VDE 8250-225	225	42.2	27.7	6.5	13.0	485	1	

VDE 8250 H

VDE HEAVY DUTY COMBINATION PLIERS with VDE insulating sleeves

- Induction-hardened precision cutting edges, hardness 62-64 HRC, for all wire types
- For heavy continuous use
- GEDORE special hardened and tempered steel, chrome-plated
- Handles with VDE insulating sleeves as per EN 60900 / IEC 60900:2004

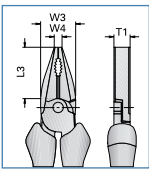

Code	No.	L	L ₃	W ₃	W ₄	T ₁	∅	↕	⊞
1550942	VDE 8250-160 H	160	35.0	22.8	5.8	10.4	228	1	
1550950	VDE 8250-180 H	180	38.5	25.6	6.5	11.0	288	1	
1550969	VDE 8250-200 H	200	39.5	27.0	6.5	12.4	369	1	



VDE 8314

VDE SIDE CUTTER with VDE dipped insulation

- For medium-hard and hard wire
- Induction-hardened precision cutting edges, hardness 63-65 HRC
- GEDORE special hardened and tempered steel, chrome-plated
- Handles with VDE dipped insulation as per EN 60900 / IEC 60900:2004, two-ply Check-Tool insulation

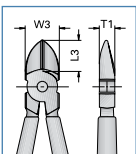

Code	No.	L	L ₃	W ₃	T ₁	∅	↕	⊞
6743540	VDE 8314-140	140	18.5	18.5	9.5	1.6	199	1
6743620	VDE 8314-160	160	19.0	22.0	10.0	1.6	253	1

VDE 8314 H

VDE SIDE CUTTER with VDE insulating sleeves

- For medium-hard and hard wire
- Induction-hardened precision cutting edges, hardness 63-65 HRC
- GEDORE special hardened and tempered steel, chrome-plated
- Handles with VDE insulating sleeves as per EN 60900 / IEC 60900:2004

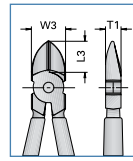

Code	No.	L	L ₃	W ₃	T ₁	∅	↕	⊞
1552155	VDE 8314-140 H	140	18.5	18.5	9.5	1.6	177	1
1552163	VDE 8314-160 H	160	19.0	22.0	10.0	1.6	231	1

VDE 8315 H

VDE ELECTRICIANS' SIDE CUTTER with VDE insulating sleeves

- Double-function electricians' side cutters for cutting and wire stripping
- Stripping holes for single or multi-strand conductors 1.5 and 2.5 mm²
- Induction-hardened precision cutting edges
- GEDORE special hardened and tempered steel, chrome-plated
- Handles with VDE insulating sleeves as per EN 60900 / IEC 60900:2004

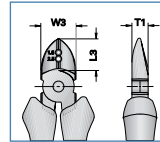

Code	No.	L	L ₃	W ₃	T ₁	Cable cross section	∅	↕	⊞
1742582	VDE 8315-160 H	160	19	22	10	1,5 / 2,5	1,6	231	1

VDE 8316

VDE POWER SIDE CUTTER with VDE dipped insulation

- For hard wire, including piano wire
- Induction-hardened precision cutting edges, hardness 63-65 HRC
- GEDORE special hardened and tempered steel, chrome-plated
- Handles with VDE dipped insulation as per EN 60900 / IEC 60900:2004, two-ply Check-Tool insulation

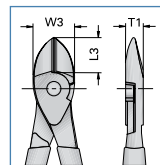

Code	No.	L	L ₃	W ₃	T ₁	∅	↕	⊞
1429590	VDE 8316-180	180	22.6	26	11	1,8	285	1
6742570	VDE 8316-200	200	22.0	28	11	2,0	341	1

VDE 8367

VDE HEAVY DUTY END CUTTING NIPPERS

- Good lever action for easy cutting
- Induction-hardened precision cutting edges, hardness 63-65 HRC
- For all wires including piano wire
- GEDORE special hardened and tempered steel, drop-forged, oil-hardened and annealed
- Handles with VDE insulated up to 1000 V, acc. to EN 60900 / IEC 60900:2004, dipped insulation: two-ply Check-Tool insulation

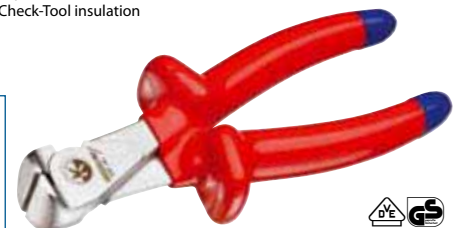
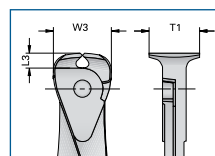

Code	No.	L	L ₃	W ₃	T ₁	∅	↕	⊞
2324830	VDE 8367-160	160	6.9	27	23.5	1.6	220	1



VDE 8316 H

VDE POWER SIDE CUTTER with VDE insulating sleeves

- For hard wire, including piano wire
- Induction-hardened precision cutting edges, hardness 63-65 HRC
- GEDORE special hardened and tempered steel, chrome-plated
- Handles with VDE insulating sleeves as per EN 60900 / IEC 60900:2004

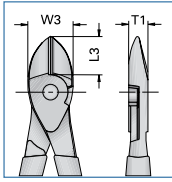

Code	No.	L	L ₃	W ₃	T ₁	Ø	↔	⊞
1550993	VDE 8316-180 H	180	22.6	26	11	1,8	267	1
1551000	VDE 8316-200 H	200	22.0	28	11	2,0	344	1

VDE 8122

VDE ROUND NOSE PLIERS with VDE dipped insulation

- Long, round jaws and serrated gripping surfaces
- GEDORE special hardened and tempered steel, chrome-plated
- Handles with VDE dipped insulation as per EN 60900 / IEC 60900:2004, two-ply Check-Tool insulation

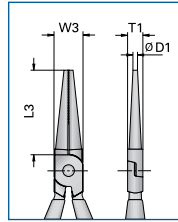

Code	No.	L	L ₃	W ₃	D ₁	T ₁	↔	⊞
6717110	VDE 8122-160	160	48	16.5	2.5	8.7	170	1

VDE 8120

VDE FLAT NOSE PLIERS with VDE dipped insulation

- Long, flat jaws and serrated gripping surfaces
- GEDORE special hardened and tempered steel, chrome-plated
- Handles with VDE dipped insulation as per EN 60900 / IEC 60900:2004, two-ply Check-Tool insulation

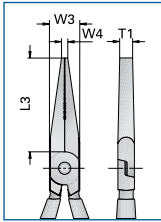

Code	No.	L	L ₃	W ₃	W ₄	T ₁	↔	⊞
6715330	VDE 8120-160	160	51	16.5	3.4	9	185	1

VDE 8122 H

VDE ROUND NOSE PLIERS with VDE insulating sleeves

- Long, round jaws and serrated gripping surfaces
- GEDORE special hardened and tempered steel, chrome-plated
- Handles with VDE insulating sleeves as per EN 60900 / IEC 60900:2004

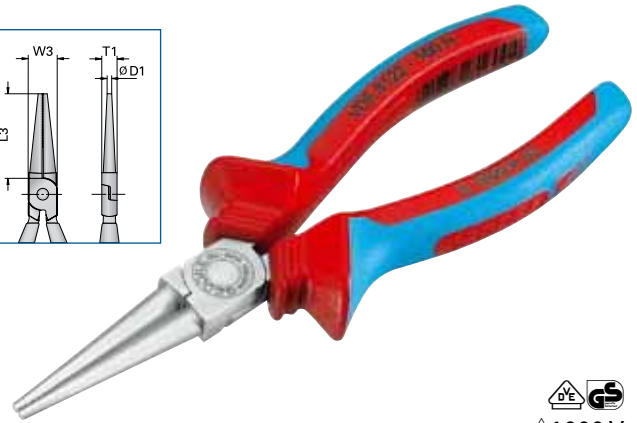
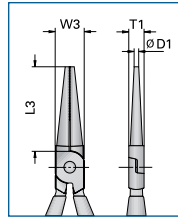

Code	No.	L	L ₃	W ₃	D ₁	T ₁	↔	⊞
1552104	VDE 8122-160 H	160	48	16.5	2.5	8.7	154	1

VDE 8120 H

VDE FLAT NOSE PLIERS with VDE insulating sleeves

- Long, flat jaws and serrated gripping surfaces
- GEDORE special hardened and tempered steel, chrome-plated
- Handles with VDE insulating sleeves as per EN 60900 / IEC 60900:2004

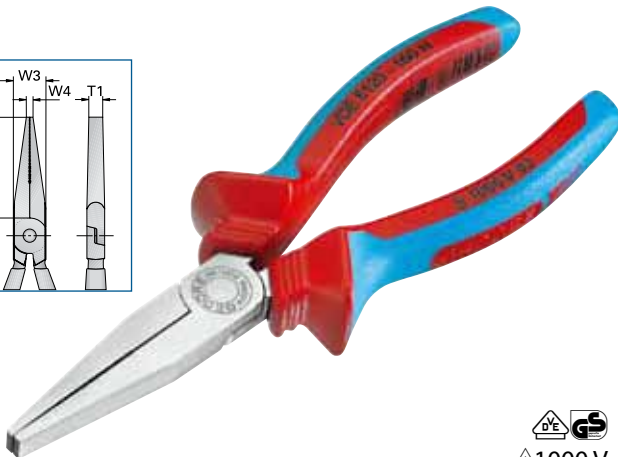
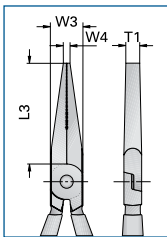

Code	No.	L	L ₃	W ₃	W ₄	T ₁	↔	⊞
1552090	VDE 8120-160 H	160	51	16.5	3.4	9	175	1

VDE 8132

VDE NEEDLE NOSE PLIERS with VDE dipped insulation, straight pattern

- Long, flat-round jaws, straight gripping surfaces
- Induction-hardened precision cutting edges, hardness 61-63 HRC
- GEDORE special hardened and tempered steel, chrome-plated
- Handles with VDE dipped insulation as per EN 60900 / IEC 60900:2004, two-ply Check-Tool insulation

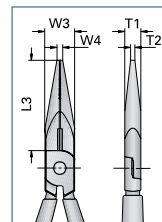

Code	No.	L	L ₃	W ₃	W ₄	T ₁	T ₂	↔	⊞
6721570	VDE 8132-160	160	50.0	16.5	3.2	9.0	2.5	193	1
6721650	VDE 8132-200	200	75.7	18.5	3.7	9.5	2.8	248	1

VDE 8132 H

VDE NEEDLE NOSE

PLIERS with VDE insulating sleeves, straight pattern

- Long, flat-round jaws, straight gripping surfaces
- Induction-hardened precision cutting edges, hardness 61-63 HRC
- GEDORE special hardened and tempered steel, chrome-plated
- Handles with VDE insulating sleeves as per EN 60900 / IEC 60900:2004

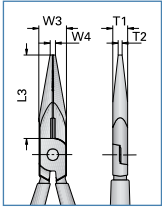

1000 V

Code	No.	L	L ₃	W ₃	W ₄	T ₁	T ₂	↕	☒
1552112	VDE 8132-160 H	160	50.0	16.5	3.2	9.0	2.5	164	1
1552120	VDE 8132-200 H	200	75.7	18.5	3.7	9.5	2.8	235	1

VDE 8132 AB

VDE NEEDLE NOSE

PLIERS with VDE dipped insulation, angled pattern

- Long, flat-round jaws, angled gripping surfaces
- Induction-hardened precision cutting edges, hardness 61-63 HRC
- GEDORE special hardened and tempered steel, chrome-plated
- Handles with VDE dipped insulation as per EN 60900 / IEC 60900:2004, two-ply Check-Tool insulation

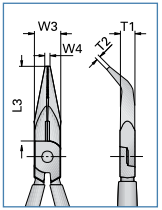

1000 V

Code	No.	L	L ₃	W ₃	W ₄	T ₁	T ₂	↕	☒
6721730	VDE 8132 AB-160	160	46.0	16.5	3.2	9.0	2.5	177	1
6721810	VDE 8132 AB-200	200	70.5	18.5	3.7	9.5	2.8	252	1

VDE 8132 AB H

VDE NEEDLE NOSE

PLIERS with VDE insulating sleeves, angled pattern

- Long, flat-round jaws, angled gripping surfaces
- Induction-hardened precision cutting edges, hardness 61-63 HRC
- GEDORE special hardened and tempered steel, chrome-plated
- Handles with VDE insulating sleeves as per EN 60900 / IEC 60900:2004

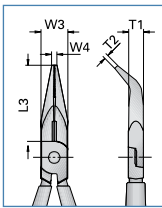

1000 V

Code	No.	L	L ₃	W ₃	W ₄	T ₁	T ₂	↕	☒
1552139	VDE 8132 AB-160 H	160	46.0	16.5	3.2	9.0	2.5	173	1
1552147	VDE 8132 AB-200 H	200	70.5	18.5	3.7	9.5	2.8	235	1



VDE S 8003

VDE PLIERS SET WITH VDE DIPPED INSULATION 3 pieces

- Packed in environmentally-friendly cardboard box
- Handles with VDE dipped insulation as per EN 60900 / IEC 60900:2004, two-ply Check-Tool insulation



1000 V

Code	No.	Contents	↕	☒
6708120	VDE S 8003	VDE 8132-160 VDE 8250-180 VDE 8314-160	760	1

VDE S 8003 H

VDE PLIERS SET WITH VDE INSULATING SLEEVES 3 pieces

- Packed in environmentally-friendly cardboard box
- Handles with VDE insulating sleeves as per EN 60900 / IEC 60900:2004



1000 V

Code	No.	Contents	↕	☒
1550594	VDE S 8003 H	VDE 8132-160 H VDE 8250-180 H VDE 8314-160 H	747	1

RZB2-5

VDE PLIERS SET 3 pieces

- In rugged plastic case
- Handles with VDE insulated up to 1000 V, acc. to EN 60900 / IEC 60900:2004, dipped insulation



1000 V

Code	No.	Contents	↕	☒
1708244	RZB2-5	VDE 8098-160 H VDE 8250-180 H VDE 8314-160 H	835	1



RZB2-11

VDE PLIERS SET 3 pieces

- ▶ In rugged plastic case
- ▶ Handles with VDE insulated up to 1000 V, acc. to EN 60900 / IEC 60900:2004, dipped insulation



Code	No.	Contents	800	800
1692291	RZB2-11	VDE 8132-160 H VDE 8250-180 H VDE 8314-160 H	865	1

VDE 1001

VDE TOOL SET 14 pieces

- ▶ With practical foam insert in sturdy PVC case
- ▶ Dimensions: 360 x 250 x 70 mm
- ▶ Cranked allen socket screwdriver No. 42 is for locking the extension VDE 1991, no VDE



VDE ASSORTMENTS

RZB1-17

VDE TOOL SET 8 pieces

- ▶ In rugged plastic case

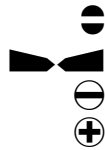

Code	No.	Contents	800	800
1828045	RZB1-17	VDE 8132-200 H VDE 8250-180 H VDE 8314-160 H VDE 2170 4 5,5 VDE 2160 PH 1 2 4615 3	1700	1

Contents

	VDE 8132-200 H
	VDE 8250-180 H
	VDE 8314-160 H
	VDE 2170 4 5,5
	VDE 2160 PH 1 2
	4615 3

Code	No.	Contents	800	800
6602560	VDE 1001	VDE 19 10 12 13 14 17 19 22 24 VDE 1993 U VDE 1990-5 -10 VDE 1989 T VDE 2170 5,5 42 2,5	3,5	1

Contents

	VDE 19 10 12 13 14 17 19 22 24
	VDE 1993 U
	VDE 1990 -5 -10
	VDE 1989 T
	VDE 2170 5,5
	42 2,5

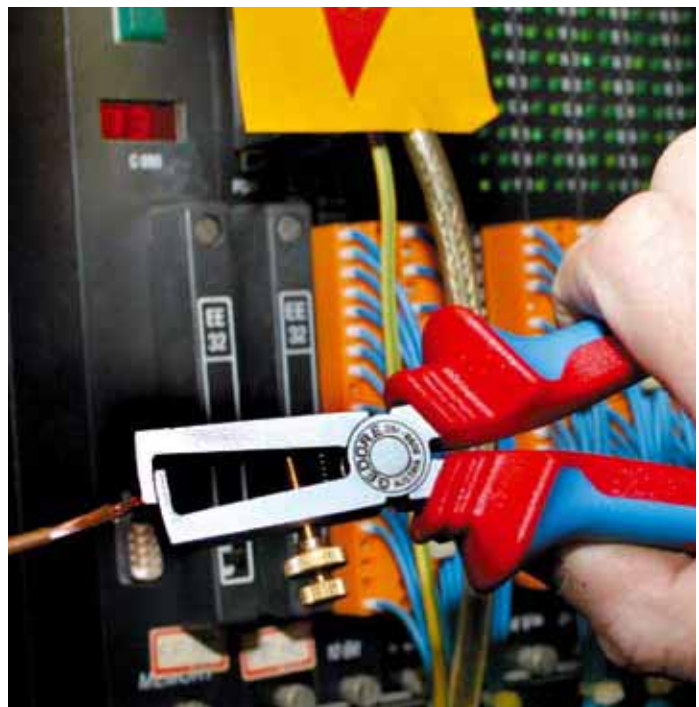

S 1023 M

TOOL ASSORTMENT FOR MECHANICAL ENGINEERS 118 pieces

- Practical entry-level toolset
- The range includes mechanical and electrical engineering tools



Code	No.	Contents	13.0
1999060	S 1023 M	118 tools in metric sizes	13.0

Contents	
	1 B 6 7 8 9 10 11 12 13 14 15 16 17 18 19 20 21 22
	D 20 4 5 6 7 8 9 10 11 12 13
	680 4 5,5 6,5
	685 3 4 5 6
	685 X 5 6 8
	687 TX T10 T15 T20 T25 T27 T30 T40
	690 1 2
	690 PZD 1 2 3
	620
	676
	699
	2090 -4
	2093 U -20
	1993 U -10 T
	19 8 9 10 11 12 13 14 15 16 17 19 22 24 27 30 32
	1987

Contents	
	1990 -5 -10
	1995
	VDE 8132 -200 H
	VDE 8250 -180 H
	VDE 8314 -160 H
	VDE 2170 4 5,5
	VDE 2160 PH 1 2
	V 4614 PLUS
	4615 3
	171 IS 1,2 1,5 2
	165 PH 00 0
	8305 -2
	8306 -5
	42 1,3 1,5 2 (5/64AF) 2,5 3 4 5 6 8 10
	97 -150

Contents	
	100 -10
	119 -3 -5
	600 H -500
	248 ST -30
	8701 2-8
	8719 2-8
	8722 2-8
	403
	4528
	710
	745
	4534 -3
	298 -04
	8354 -1
	8139 -220 TL

1090

TOOL CASE ELECTRICIAN 90 pieces

- The perfect tool set for the electrician or property manager
- A thoughtful assortment for the work to be done
- Packed in a strong plastic case with aluminium frame
- Three steel hinges, screwed handle, fitted with built in locks
- May be used wherever the right tools have to be always at hand
- GEDORE vanadium tools, chrome-plated
- Dimensions: W 460 x D 380 x H 200 mm
- No. 1090 = set with case
- No. S 1090 = set without case
- No. WK 1090 L = case empty



1090

Code	No.	Contents	13.2
6601590	1090	90 tools in case	13.2
6601400	S 1090	90 tools without case	8.3
5600060	WK 1090 L	Case empty	4.2

Contents	
	401
	401 A [10x]
	6 14x17 18x19 21x23 22x24
	8 4 4,5 5 5,5 6 7 8 9 10 11 12 13
	20 4 4,5 5 5,5 6 7 8 9 10 11 13
	2087
	2095

Contents	
	2098
	2090 -4
	2093 U -3
	42 2 (5/64AF) 2,5 3 4 5 6 7 8 10
	60 CP 10
	156 5

Contents	
	2153 5,5
	2161 PH 1
	2160 PZ 1 2
	VDE 2160 PH 1 2
	VDE 2170 3,5 4 5,5 6,5
	4615 3,5
	173 5,5 8

	Contents
	174 1
	745
	4522
	4534 -3
	145 10 JC
	8096 -140
	VDE 8098 -160
	VDE 8120 -160
	VDE 8250 -180
	VDE 8132 AB -160

	Contents
	VDE 8316 -200
	95 -175
	99 10-2 10-4
	101
	112 A -250

	Contents
	112 S
	600 H -300
	72 H -100
	E-1090 LK LZ LF LS

1091

ELECTRICIANS TOOL CASE 18 pieces

- Robust tool case with 18-piece basic assortment. Particularly suitable for beginners in electronic professions
- From eco-friendly tanned cowhide
- Carefully processed with strong industrial seams
- Base insert from zinc-plated sheet steel
- Edges reinforced with aluminium angle brackets, metal parts durable riveted
- With feet to protect sensitive surfaces
- Front part can be lowered for quick access to the tools, with two key locks to prevent inadvertent opening
- Removable carrying strap with shoulder protector and sturdy carrying handle
- Anti-theft protection due to two lockable notches, delivery includes two keys
- Document partition
- Interior measurements 430 x 200 x 290 mm
- No. 1091 = set with case
- No. WK 1091 L = case empty



Code	No.	Contents	Weight
1953710	1091	18 tools in case	6.0
1953729	WK 1091 L	Case empty	4.2

	Contents
	VDE 2133 7 8 10
	VDE 2160 PH 1 2 3
	VDE 2170 3 4 5,5
	4528
	4533 -2
	V 4614 PLUS
	4629
	8097
	VDE 8132 -160 H
	VDE 8250 -180 H
	VDE 8316 -180 H
	E-1091 ST

VDE 1030

VDE TOOL CABINET 108 pieces

- Complete with a selection of VDE tools
- Dimensions: 190 x 500 x 750 mm



Code	No.	Contents	Weight	Quantity
6602130	VDE 1030	108 tools in cabinet	46.0	1
5600730	VDE 1030 L	Cabinet, empty	20.0	1

	Contents
	VDE 2133 5 6 7 8 9 10 11 12 13
	VDE 19 10 11 12 13 14 15 17 19 22 24 27 30 32
	VDE IN 19 5 6 8
	VDE 1990 -5 -10
	VDE 1993 U
	VDE 2170 2,5 4 5,5 6,5
	VDE 2160 PH 0 1 2
	VDE 894 10 11 12 13 14 15 16 17 19
	VDE 8098 -160 H
	VDE 8132 -160 H
	VDE 8250 -160 H
	VDE 8314 -160 H
	VDE 4507 -4
	647
	171 IS 1,2 1,5 2
	165 PH 00 0
	8305 -2
	8306 -5
	4 K -500
	1500 H 1-50 [6x] 2-13 [17x] 3 [27x]

S 1093

TOOL ASSORTMENT 26 pieces

- Particularly suited as the initial outfit for electrical specialists
- The GEDORE tool case or tool trolley are suited for mobile assignments



Inhalt
142 10 C
VDE 8250 -180 H
VDE 8132 -160 H
VDE 8314 -160 H
VDE 2170 4,5,5,6,5,8
VDE 2160 PZ 1 2
V 4614 PLUS
42 2 (5/64AF) 2,5 3 4 5 6 8 10
4533 -2
4528
8097
600 H -500
112 A -250
110 HS -318
0175 -06

Code	No.	Contents	
2319942	S 1093	26 Tools	

VDE ACCESSORIES

VDE 910

VDE RUBBER COVER SHEET

- VDE protective equipment acc. to VDE 0680, Part 1



Code	No.	L	W		
1826816	VDE 910 13	130	130	40	1
1826832	VDE 910 25	250	350	210	1
1827030	VDE 910 50	500	500	430	1
1828193	VDE 910 60	600	600	700	1
1828207	VDE 910 100	1000	1000	1800	1
1828215	VDE 910 120	1200	1200	2950	1

VDE 912

VDE ELECTRICIANS' SAFETY GLOVES

- Acc. to DIN EN 60903
- Made of natural latex

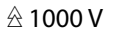

Code	No.		
1828274	VDE 912 9	215	1
1828282	VDE 912 10	215	1



VDE 911

VDE INSULATION MAT

- VDE protective equipment acc. to VDE 0303



Code	No.	L	W		
1828258	VDE 911 100	1000	1000	6.0	1
1828266	VDE 911 1000	10000	1000	60.0	1

VDE 912

UNDER-GLOVES for VDE 912



Code	No.		
1828290	VDE 912 50	50	1

VDE VARIOUS

VDE 4522

VDE CABLE KNIFE

- Strong, straight blade made from hardened and tempered steel
- Tough, resilient plastic handle
- With VDE insulation according to EN 60900 / IEC 60900:2004



Code	No.				
6690400	VDE 4522	50	180	104	5

VDE 4527

VDE CABLE KNIFE with hooked blade

- For slitting and stripping damp-proof installation cables
- With blade protector
- With VDE insulation according to EN 60900 / IEC 60900:2004



Code	No.				
6698490	VDE 4527	40	203	98	1

V 406

HACKSAW

- For pinned hacksaw blades, 148 mm
- Insulated handle up to 1000 V
- Not certified acc. to VDE

1000 V



Code	No.			
6120060	V 406	265	229	1

VDE 913

VDE PLASTIC CLAMP

- VDE protective equipment acc. to VDE 0680, Part 1



Code	No.			
1828304	VDE 913 80	80	30	1
1828312	VDE 913 160	160	70	1

VDE 914

VDE METER CONNECTION FITTINGS

- For insulating single cores
- Conical form
- Made from resilient plastic
- VDE 914 1 with Designation 1
- VDE 914 2 with Designation 2
- VDE 914 3 with Designation 3



1000 V

Code	No.				
2324938	VDE 914 1	80	10	1	
2324946	VDE 914 2	80	10	1	
2324954	VDE 914 3	80	10	1	



More VDE tools on request!
Haven't you found the right tool?
Ask us about custom-orders.
Your problems are our assignments.

www.gedore.com



Sheath-stripping, wire-stripping, crimping tools etc. can be found on pages



332
-
339





No. 1990/5

GEDORE

GEDORE

No. 381 030

GEDORE

No. 381 030



++ A STRONG GRIP +



SERVICE / FEATURES		518 - 519
CHAIN PIPE WRENCHES		520 - 523
STRAP WRENCHES		523
WATER PUMP / UNIVERSAL PLIERS		524 - 525
PIPE CUTTERS FOR STEEL AND CAST IRON PIPES		526
PIPE CUTTERS / PIPE DEBURRING REAMER FOR STAINLESS STEEL PIPES		527
PIPE CUTTERS / PIPE DEBURRING REAMER / CALIBRATING TOOL FOR COPPER PIPES		528 - 529
PIPE CUTTERS FOR PLASTIC PIPES		530
FLARING TOOLS		531 - 532
INSTALLATION TOOLS		533
BASIN WRENCHES		534
PLUMBING WRENCHES		535
TAP RESEATING TOOLS		535
STEPPED KEYS / VALVE SPANNER		536
SHEET METAL FORMING TOOLS		537
TIN SNIPS		538
ARC PUNCHES		539
PIPE CLEANING TOOLS		540 - 541





INSTALLATION TOOLS



+ TOP QUALITY TO MEET MAXIMUM REQUIREMENTS

- ▀ Use of the most up-to-date machinery and environmentally-friendly production processes
- ▀ Everything is based on tightly controlled and selected materials
- ▀ Experienced and reliable specialists vouch for precision-like processing
- ▀ Stringent quality checks after each production step ensure a constantly high level
- ▀ High-grade industrial quality for the toughest forms of continuous use and safety in everyday work

EVERYTHING HANDLED DOWN TO A TEE

- ▀ The absence of Chrome 6 in the tools is simply a matter of course for us and has been so for many years.
- ▀ Best-possible results are down to the unique manufacturing processes and special treatment for tools



+ PRECISION, DIMENSIONED ACCURACY AND FITTING EXACTNESS

- ▀ The most important requirements for non-taxing and safe working



SERRATED FACE FLAME-HARDENING

- ▀ All GEDORE Swedish pipe wrenches are additionally flame-hardened at the teeth by a hardness unit developed by our Special Machinery Construction section. A uniform distribution of temperature across the entire jaw surface ensures a stress-relieved additional hardening of the surface of the teeth. The DIN specified hardness values are surpassed with ease by GEDORE pipe wrenches. The grip holds up for years even under the rough and tough daily routine.



SELF-CLAMPING SERRATED FACE

- ▀ The self-clamping serrated face grips reliably and firmly and this is intensified as the turning resistance is increased. There is no need to press the handles together. GEDORE Swedish pipe wrenches have that non-slip grip – even on smooth pipes.



ROUND THREAD WITH UNDETACHABLE ADJUSTING NUT

- ▀ A non-detachable adjusting nut with round thread ensures a width adjustment. A round thread stands up better than other thread types to mechanical damage and soiling. It allows the adjusting nut on the pliers shaft to run rapidly, evenly and precisely.

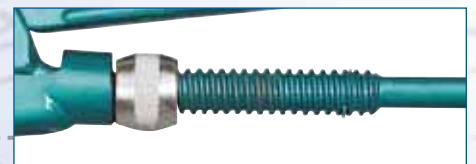

+ + PIPE WRENCHES SUBJECT TO FULL HARDENING/TEMPERING

- ▀ All GEDORE Swedish pipe wrenches are **hardened and tempered** across their entire length and cross-section.



++ FOR PIPE WRENCHES +

The pipe pliers comprise a hook, shaft, sleeve, knurled nut and locking ring. The individual parts are initially manufactured separately. Final machining is carried out on the assembled pipe wrench.

THE HEAD

- 1 The blank is stamped in an eccentric press from steel flat stock. The steel used is GEDORE chrome-vanadium special steel. The thick head and slim shaft can already be identified
- 2 The blank is heated precisely to forging temperature in the continuous furnace and then forged in a forging die
- 3 The excess material is removed by de-burring. Scale is removed by sand blasting and grinding
- 4 Thread cutting
- 5 The slot for the shaft is milled. The teeth are broached

THE SLEEVE

- 1 The sleeve is stamped from steel
- 2 The sleeve is pre-bent
- 3 The stamped geometry gives the finished sleeve high flexural strength. It is subsequently hardened in the continuous furnace

THE SHAFT

- 1 The blank is stamped in an eccentric press from steel flat stock. The steel used is GEDORE chrome-vanadium special steel. The thick head and slim shaft can already be identified.
- 2 The blank is heated precisely to forging temperature in the continuous furnace and then forged in a forging die.
- 3 The excess material is removed by de-burring. Scale is removed by sand blasting and grinding.
- 4 The rivet hole for the sleeve is drilled.
- 5 The joint is machined to its final geometry in the machining centre.
- 6 The teeth are broached.

ASSEMBLY AND END MACHINING: +



In the area of the slot, the hook is widened and pushed through the shaft. Once this is done, the hook is pressed back to its original size



In the continuous furnace, the pipe wrench is heated to hardening temperature, quenched in a water bath and completely hardened through. To achieve the optimum combination of hardness and toughness, the wrench is annealed throughout. The teeth of GEDORE pipe wrenches are then once again flame hardened. The additional hardness this achieves ensures a long tool life. The sleeve is pushed on the shaft and riveted to the hook. Before entering the paint shop, the pipe wrench is straightened, descaled and degreased



The pipe wrench is stove enamelled. The side surfaces of the head are ground and treated with a corrosion-protection agent. The final step is to screw on the knurled nut and the locking ring





PIPE WRENCHES

ECK-SCHWEDE-SNAP® - THE SWEDISH

Tried and tested bestseller with a powerful grip for more than 50 years



Working principle

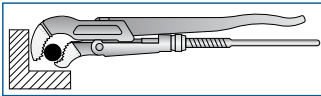
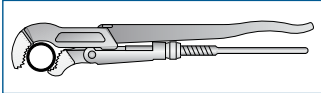

The jaw form of the snap® reliably prevents the workpiece slipping out, and ensures maximum freedom of movement in confined spaces

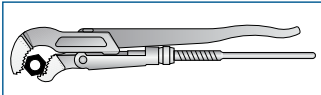
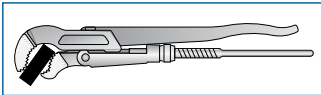

The curvature of the jaws adapts ideally to different profiles, enabling the snap® to grip hexagonal nuts - gently and securely



5 The mouth of the jaw opening is always narrower than the pipe diameter, reliably preventing the workpiece from slipping out. Securely grips pipes and screw couplings

1 The special, supplementary flame hardening of the teeth increases and improves the grip and durability of the SNAP®

2 Force is always applied by SNAP® simultaneously at three points, ensuring a secure grip with low hand pressure

3 Hook and leg made from drop-forged GEDORE chrome-vanadium special steel, hardened and tempered

4 Stove enamelling guarantees long-life protection



100

ELBOW PIPE WRENCH ECK-SCHWEDE-SNAP® - THE SWEDISH THE ORIGINAL

- ▶ Acc. to DIN 5234, Form C
- ▶ Heavy-duty pipe wrench with three-point grip
- ▶ For working in confined spaces
- ▶ GEDORE chrome-vanadium special steel
- ▶ Drop forged
- ▶ Tempered, teeth additionally hardened
- ▶ Teeth offset against direction of rotation
- ▶ Roller secured against loss
- ▶ Stove enamelled blue, head ground

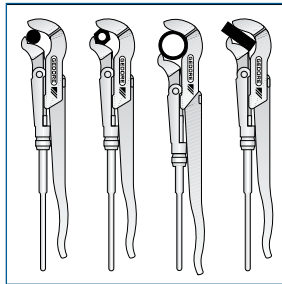

Code	No.	Size	mm	mm	mm	
4500060	100 1/2	1/2	35	245	380	1
4500140	100 1	1	48	320	800	1
4500220	100 1.1/2	1.1/2	60	420	1400	1
4500300	100 2	2	80	550	2240	1
4500490	100 3	3	110	630	3580	1

9100

PIPE WRENCH S

- ▶ Acc. to DIN 5234, Form C
- ▶ For working in confined spaces
- ▶ GEDORE chrome-vanadium special steel
- ▶ Drop forged
- ▶ Tempered, teeth additionally hardened
- ▶ Teeth offset against direction of rotation
- ▶ Roller secured against loss
- ▶ Stove enamelled silver



Code	No.	Size	mm	mm	mm	
4531960	9100 1/2	1/2	35	245	380	1
4532180	9100 1	1	48	320	800	1
4532260	9100 1.1/2	1.1/2	60	420	1400	1
4532340	9100 2	2	80	550	2240	1
4532420	9100 3	3	110	630	3580	1





175

PIPE WRENCH Swedish pattern

- Acc. to DIN 5234 Form A
- Especially sturdy type for heavy use
- Head angled 85°
- GEDORE chrome-vanadium special steel
- Drop forged
- Tempered, teeth additionally hardened
- Teeth offset against direction of rotation
- Roller secured against loss
- Stove enamelled blue

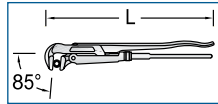

Code	No.	Size	mm	L	↕	☰
6437260	175 3/4	3/4	38	280	505	1
6437340	175 1	1	44	320	694	1
6437420	175 1.1/2	1.1/2	62	430	1471	1
6437500	175 2	2	76	580	2550	1
6437690	175 3	3	105	670	3780	1
6437770	175 4	4	130	760	5635	1

176

ELBOW PIPE WRENCH

- Acc. to DIN 5234 Form B
- For working in confined spaces
- Narrow head, multi-grip jaw pattern, angled 52°
- GEDORE chrome-vanadium special steel
- Drop forged
- Tempered, teeth additionally hardened
- Teeth offset against direction of rotation
- Roller secured against loss
- Stove enamelled blue

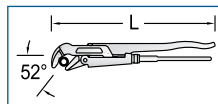

Code	No.	Size	mm	L	↕	☰
6438070	176 3/4	3/4	38	280	445	1
6438150	176 1	1	44	320	775	1
6438230	176 1.1/2	1.1/2	62	430	1403	1
6438310	176 2	2	76	580	2571	1
6438580	176 3	3	105	670	3640	1



Deviant packing units see article description.

152

HIGH-SPEED PIPE WRENCH with screw adjuster

- GEDORIT powder-coated blue hammer finish
- Forged components
- Induction-rehardened serrated faces
- Quick and easy setting with screw adjuster - single-hand adjustment
- Gripping faces selfinhibiting

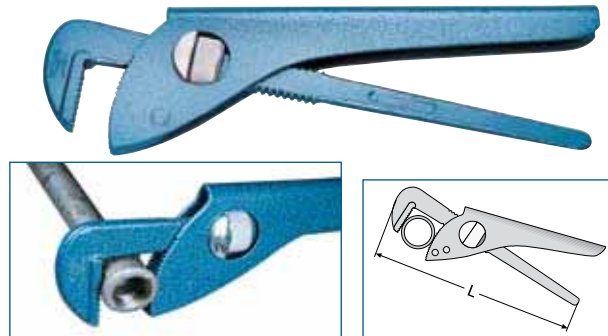

Code	No.	L	L'	mm	inch	Pipes	Sockets	↕	☰
6419280	152 7	178	7	35	1.3/8	1"	3/4"	300	1
6419360	152 9	228	9	42	1.5/8	1.1/4"	1"	531	1
6419440	152 11	281	11	61	2.3/8	2"	1.3/4"	851	1
6419520	152 12	315	12	74	3	2.1/2"	2"	1038	1
6419600	152 14	360	14	90	3.9/16	3"	-	1656	1

152 NI

HIGH-SPEED PIPE WRENCH NICKEL-PLATED with screw adjuster

- Nickel-plated
- Forged components
- Induction-rehardened serrated faces
- Quick and easy setting with screw adjuster - single-hand adjustment
- Gripping faces selfinhibiting

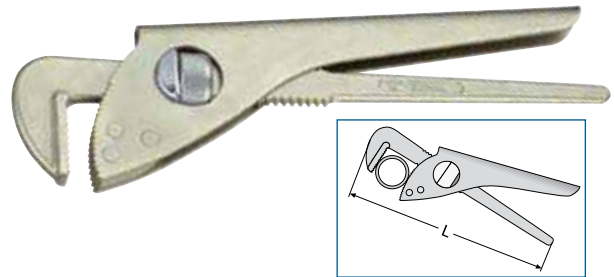

Code	No.	L	L'	mm	inch	Pipes	Sockets	↕	☰
1826700	152 9 NI	228	9	42	1.5/8	1.1/4"	1"	520	1
1826727	152 12 NI	315	12	74	3	2.1/2"	2"	1000	1

152 G

HIGH-SPEED PIPE WRENCH curved, with screw adjuster

- GEDORIT powder-coated blue hammer finish
- Forged components
- Induction-rehardened serrated faces
- Quick and easy setting with screw adjuster - single-hand adjustment
- Gripping faces selfinhibiting

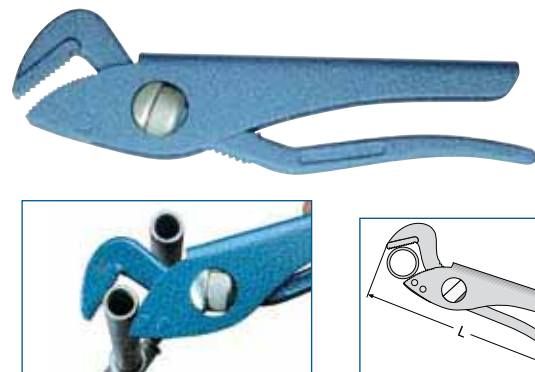

Code	No.	L	L'	mm	inch	Pipes	Sockets	↕	☰
1394835	152 G-7	175	7	35	1.3/8	1"	3/4"	273	1
1394843	152 G-9	225	9	42	1.5/8	1.1/4"	1"	556	1
1394851	152 G-12	300	12	74	3	2"	2"	1033	1





225

PIPE WRENCH STILLSON

- ▶ Stillson type, forged parts tempered
- ▶ Teeth offset against direction of rotation and induction-hardened
- ▶ GEDORE special hardened and tempered steel
- ▶ Ground upto and including 24"



Code	No.	↳mm↪	↳inch↪	mm	inch	↳mm↪	↳inch↪	↳mm↪	↳inch↪
6450280	225 8	180	8	27	1.1/16	3/4	297	1	
6450360	225 10	240	10	35	1.3/8	1	584	1	
6450440	225 12	280	12	44	1.3/4	1.1/4	760	1	
6450520	225 14	320	14	48	1.7/8	1.1/2	1097	1	
6450600	225 18	410	18	60	2.3/8	2	1691	1	
6450790	225 24	540	24	76	3	2.1/2	2825	1	
6450870	225 36	920	36	100	4	3.1/2	6995	1	
6450950	225 48	1220	48	145	5.3/4	5	11125	1	

227

PIPE WRENCH American pattern

- ▶ Extra heavy type
- ▶ Forged parts tempered
- ▶ Teeth offset against direction of rotation and induction-hardened
- ▶ Handle made from malleable cast iron
- ▶ GEDORE special hardened and tempered steel, ground
- ▶ Handles stove enamelled



Code	No.	↳mm↪	mm	↳inch↪	↳mm↪	↳inch↪
6453030	227 8	190	38	1	440	1
6453110	227 10	245	48	1.1/2	850	1
6453460	227 14	325	60	2	1751	1
6453540	227 18	415	76	2.1/2	2701	1
6453620	227 24	560	89	3	4280	1

E-225

PARTS

Combine the spare part order no. with the correct size:

- ▶ E-225 AD = housing and rivet
- ▶ E-227 B = roller
- ▶ E-227 C = jaw
- ▶ E-227 D = rivet and spring

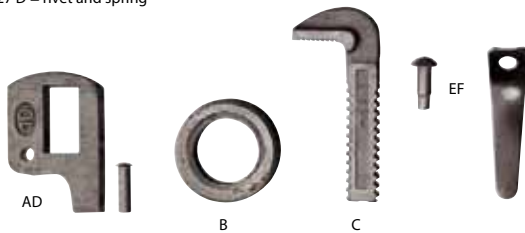

Code	No.	Description	↳mm↪
1490923	E-225 AD 8	Housing and rivet 8"	50
1490931	E-225 AD 10	Housing and rivet 10"	117
1490958	E-225 AD 12	Housing and rivet 12"	156
1490966	E-225 AD 14	Housing and rivet 14"	130
1490974	E-225 AD 18	Housing and rivet 18"	250
1490982	E-225 AD 24	Housing and rivet 24"	430
5440860	E-225 AD 36	Housing and rivet 36"	660
5440940	E-225 AD 48	Housing and rivet 48"	860
1490834	E-225 B 8	Roller 8"	10
1490842	E-225 B 10	Roller 10"	25
1490850	E-225 B 12	Roller 12"	35
1490869	E-225 B 14	Roller 14"	45
1490877	E-225 B 18	Roller 18"	60
1490885	E-225 B 24	Roller 24"	135
5448840	E-225 B 36	Roller 36"	240
5448920	E-225 B 48	Roller 48"	310
1490753	E-225 C 8	Jaw 8"	85
1490761	E-225 C 10	Jaw 10"	190
1490788	E-225 C 12	Jaw 12"	260
1490796	E-225 C 14	Jaw 14"	340
1490818	E-225 C 18	Jaw 18"	470
1490826	E-225 C 24	Jaw 24"	830
5449730	E-225 C 36	Jaw 36"	1600
5449810	E-225 C 48	Jaw 48"	2500
1490990	E-225 EF 8	Rivet and spring 8"	3
1491008	E-225 EF 10	Rivet and spring 10"	3
1491016	E-225 EF 12	Rivet and spring 12"	3
1491040	E-225 EF 14	Rivet and spring 14"	3
1491024	E-225 EF 18	Rivet and spring 18"	3
1491032	E-225 EF 24	Rivet and spring 24"	3
5452870	E-225 EF 36	Rivet and spring 36"	10
5452950	E-225 EF 48	Rivet and spring 48"	10

E-227

PARTS

Combine the spare part order no. with the correct size:

- ▶ E-227 A = spare spring
- ▶ E-227 B = spare adjuster screw
- ▶ E-227 C = spare jaw with pin
- ▶ E-227 D = spare hook

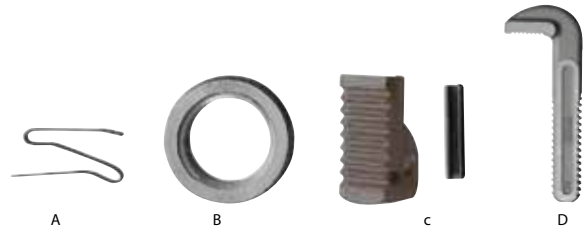

Code	No.	Description	↳mm↪
1491245	E-227 A 8	Spring 8"	1
1491253	E-227 A 10	Spring 10"	2
1491261	E-227 A 14	Spring 14"	5
1491296	E-227 A 18	Spring 18"	6
1491318	E-227 A 24	Spring 24"	8
1491121	E-227 B 8	Roller 8"	12
1491148	E-227 B 10	Roller 10"	25
1491164	E-227 B 14	Roller 14"	50
1491172	E-227 B 18	Roller 18"	80
1491180	E-227 B 24	Roller 24"	140
1491199	E-227 C 8	Jaw with pin 8"	25
1491202	E-227 C 10	Jaw with pin 10"	35
1491210	E-227 C 14	Jaw with pin 14"	60
1491229	E-227 C 18	Jaw with pin 18"	85
1491237	E-227 C 24	Jaw with pin 24"	150
1491067	E-227 D 8	Hook 8"	110
1491075	E-227 D 10	Hook 10"	210
1491091	E-227 D 14	Hook 14"	440
1491105	E-227 D 18	Hook 18"	720
1491113	E-227 D 24	Hook 24"	1000



137 • 138 • 139



346
-
347



CHAIN PIPE WRENCHES

120

CHAIN PIPE WRENCH BOSS

- Ideal for use in areas with restricted access
- Ratchet-type operation
- Handle in GEDORE chrome-vanadium special steel
- Drop forged
- Tempered, teeth additionally hardened
- Stove enamelled blue

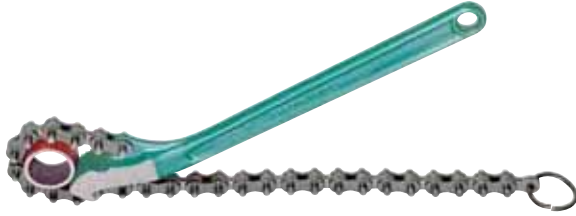

Code	No.	Size	Ø mm	l mm	l mm	l mm	l mm
4502350	120000	3/8-4	17-114	300	720	1	

E 120

SPARE CHAIN BOSS

Code	No.	l mm	l mm	l mm
4535280	120200	450	320	1

122

CHAIN PIPE WRENCH American pattern

- High efficiency due to maximum-possible lever action
- Tempered steel acc. to EN 10083
- With hardened exchangeable jaws, toothed on both sides
- Stove enamelled blue



Code	No.	Size	Ø mm	l mm	l mm	l mm	l mm
4535360	122002	1/8-2	10-60	20	510	2.5	1
4535440	122003	1/4-3	13-89	28	710	4.0	1
4502430	122004	3/4-4	27-114	37	940	6.6	1
4502510	122006	1-6	33-168	43	1090	9.1	1
4548340	122008	1.1/2-8	48-219	50	1275	13.0	1
4548420	122012	2-12	60-324	63	1600	22.1	1

E 122

PARTS

- Spare chain no. 122202 - 122212
- Spare jaws (pair) no. 122302 - 122312



Code	No.	Description	l mm	l mm	l mm
4548500	122202	Spare chain 1/8-2"	380	0.7	1
4548690	122203	Spare chain 1/4-3"	490	1.0	1
4548770	122204	Spare chain 3/4-4"	610	1.4	1
4548850	122206	Spare chain 1-6"	850	2.2	1
4548930	122208	Spare chain 1.1/2-8"	1080	3.3	1
4549070	122212	Spare chain 2-12"	1450	5.7	1
4549150	122302	Spare jaws (pair) 1/8-2"	0.3	1	
4549230	122303	Spare jaws (pair) 1/4-3"	1.0	1	
4549310	122304	Spare jaws (pair) 3/4-4"	1.5	1	
4549580	122306	Spare jaws (pair) 1-6"	2.1	1	
4549660	122308	Spare jaws (pair) 1.1/2-8"	2.6	1	
4549740	122312	Spare jaws (pair) 2-12"	4.5	1	

STRAP WRENCHES

36

STRAP WRENCH

- With strong, non-slip fabric strap, extra wide = 25 mm
- 36 1-140 made from C45 steel
- 36 2-200 made from GEDORE vanadium steel 31CrV3
- Chrome-plated
- Spare straps E-36 1 / E-36 2



Code	No.	mm	l mm	Ø mm	Ø inch	l mm	l mm
6327320	36 1-140	25	220	140	9/64	278	1
6327400	36 2-200	25	285	200	13/64	578	1
5327380	E-36 1-140	25	480			62	1
5327460	E-36 2-200	25	900			104	1

➔ 36 Z



575



126

STRAP WRENCH

- Very gentle to surfaces, particularly suitable for chrome-plated fittings and polished surfaces
- Handle in light metal, enamelled blue
- With high-strength nylon strap



Code	No.	mm	Ø inch	Ø mm	l mm	l mm	l mm
1468308	126008	27	8	220	300	325	1

E 126

SPARE STRAP

- High-strength nylon strap

Code	No.	mm	l mm	l mm	l mm
1468316	126208	27	950	35	1



WATER PUMP / UNIVERSAL PLIERS

142

UNIVERSAL PLIERS

- ▶ Acc. to DIN ISO 8976 Form C
- ▶ With safety box joint and protection against blocking
- ▶ Fine adjustment
- ▶ 142 10 = 15 settings
- ▶ 142 12 = 17 settings
- ▶ Single-hand push-button adjustment
- ▶ Long slim jaws
- ▶ Version C = slim handles with forged serrations
- ▶ Version TL = clear varnished, with blue dipped handle protectors
- ▶ Version JC = chrome-plated, 2-component handles
- ▶ Offset gripping faces for self-gripping of nuts and pipes
- ▶ GEDORE chrome-vanadium special steel
- ▶ Induction-rehardened serrated faces



142-12 C



142-10 C



142-10 JC



142-10 TL



142-12 TL



Code	No.	L ₁	L ₂	b	h	mm		
6416180	142 10 TL	255	39	7.5	48	38	371	5
6416260	142 10 C	250	39	7.5	48	38	380	5
6416340	142 10 JC	260	39	7.5	48	38	417	5
1995413	142 12 TL	309	43	8.5	55	44	550	1
1995553	142 12 C	300	43	8.5	55	44	530	1

143

UNIVERSAL PLIERS 5 settings

- ▶ Acc. to DIN ISO 8976 Form B
- ▶ Forged twin-groove lay-on slip joint and toothed recess
- ▶ Offset gripping faces for self-gripping of nuts and pipes
- ▶ With finger protection
- ▶ GEDORE chrome-vanadium special steel, chrome-plated
- ▶ Induction-rehardened serrated faces



C



JC

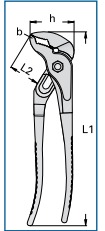

Code	No.	L ₁	L ₂	b	h	mm		
6410650	143 10 C	248	40	10.6	56	32	412	5
6415880	143 10 JC	252	40	10.6	56	32	459	5

144

MECHANICS PLIERS 7 settings

- ▶ Acc. to DIN ISO 8976 Form A
- ▶ Lay-on slip joint and straight, serrated jaws
- ▶ GEDORE chrome-vanadium special steel
- ▶ Induction-rehardened serrated faces

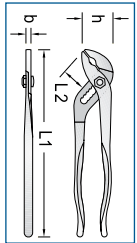

Code	No.	L ₁	L ₂	b	h	mm	
6411110	144 4.1/2 C	113	13	3.8	23	16	42
6411380	144 7 C	175	22	5.5	35	26	138



923



487



145

WATER PUMP PLIERS

- Acc. to DIN ISO 8976 Form A
- Lay-on slip joint and toothed recess
- Induction-rehardened serrated faces, with finger protection
- GEDORE chrome-vanadium special steel, chrome-plated
- Execution C = handles cross-hatched
- Execution JC = with 2-component handle sleeves
- 145 10 = 7 settings, with extra narrow jaws
- 145 15 = 9 settings
- 145 20 = 11 settings



145-10 C



145-10 JC



145-15 C



145-20 C

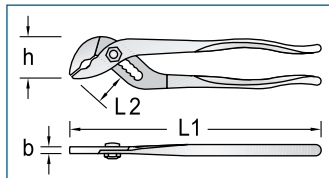

Code	No.	L ₁	L ₂	b	h	mm	mm	mm
6412000	145 10 C	250	41	7.8	47	39	365	5
6415610	145 10 JC	260	41	7.8	47	39	425	5
6412190	145 15 C	375	46	10.4	72	50	854	1
6412270	145 20 C	500	55	13.8	98	65	1747	1

146

UNIVERSAL PLIERS 7 settings

- Acc. to DIN ISO 8976 Form C
- With safety box joint and finger protection
- Automatic clamping with offset gripping surfaces
- GEDORE chrome-vanadium special steel, chrome-plated, with polished surface
- Induction-rehardened serrated faces

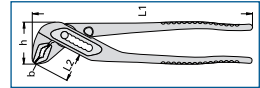

Code	No.	L ₁	L ₂	b	h	mm	mm	mm
6413240	146 10 CP	250	32.5	4.8	48	31	335	5

146 B

SPECIAL WATER PUMP PLIERS 5 settings

- Acc. to DIN ISO 8976 Form C
- With fast adjustment and tooth-lock box joint and toothed aperture
- Absolutely safe - no slipping out of adjustment during work
- With finger protection
- GEDORE chrome-vanadium special steel, chrome-plated, polished

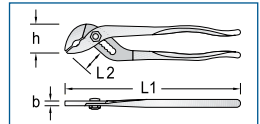

Code	No.	L ₁	L ₂	b	h	mm	mm	mm
6412510	146 B 10	250	45	8	55	50	485	1

9144

WATER PUMP PLIERS

- To DIN ISO 8976
- Chrome-vanadium steel
- With box joint
- Drop forged

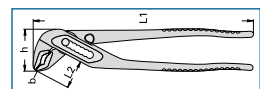

Code	No.	L ₁	L ₂	b	h	mm	mm	mm
4533230	914417	175	28	7.0	33	26	150	5
4533310	914424	240	35	7.5	40	33	290	5
4533580	914430	300	40	9.0	60	45	480	5

920



487



PIPE CUTTERS FOR STEEL AND CAST IRON PIPES

210

LINK PIPE CUTTER for steel, SML and cast iron pipes

- Low space requirements due to ratchet-type operation
- Depending on requirements, may be shortened or extended
- Usable for pipes from approx. 80 mm internal diameter
- Stove enamelled blue

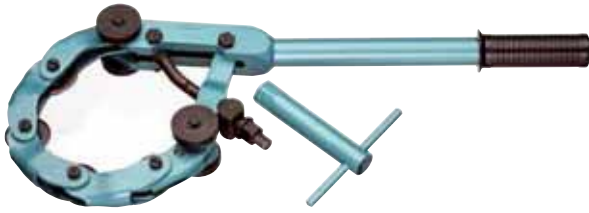

Code	No.	up to Ø mm	Cutting wheels	↕	↔
4536170	210010	100	3	4.9	1
4550910	210012	125	4	5.3	1
4536250	210015	150	5	5.7	1
4551050	210017	175	6	6.1	1
4536330	210020	200	7	6.5	1
4551130	210025	250	9	7.3	1
4551210	210030	300	11	8.1	1

E 210

SPARE PARTS

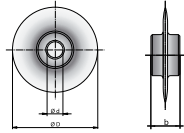

Code	No.	Ø D	b	Ø d	↕	↔
4536410	210200	50	11	11	80	1
Cutting wheel for steel						
4551480	210500				290	1
Spare link						
4536680	210600				27	1
Spare bolt						

220

PIPE CUTTER TUBEX® for steel pipes

- Heavy-duty pipe cutter with 1 cutting wheel
 - For steel pipes (in sizes 2" and 4", by exchanging the cutting wheels, may also be used for cast iron or stainless steel pipes)
 - Frame in malleable cast steel, size 1.1/4" forged from steel
 - With elastic feed using especially-installed spring system (size 2")
 - Spindle protected by sleeve extension
 - Stove enamelled blue, spindle gun-metal finished
- Version with 3 cutting wheels see no. 222



Code	No.	Size	Ø mm	↔ (mm)	↕	↔
4503320	220012	1/8-1.1/4"	10-42	275	1.3	1
4503400	220020	1/8-2"	10-60	380	2.9	1
4503590	220040	1.1/4-4"	42-114	520	5.0	1

221

PIPE CUTTER TUBEX® for SML and cast iron pipes

- Heavy-duty pipe cutter with 1 cutting wheel
 - For cast iron pipes (by exchanging the cutting wheels, may also be used for steel and stainless steel pipes)
 - Frame in malleable cast steel
 - With elastic feed using especially-installed spring system (size 2")
 - Spindle protected by sleeve extension
 - Stove enamelled blue, spindle gun-metal finished
- Version with 3 cutting wheels see no. 223



Code	No.	Size	Ø mm	↔ (mm)	↕	↔
4624380	221020	1/8-2"	10-60	380	2.9	1
4552880	221040	1.1/4-4"	42-114	520	5.0	1

222

PIPE CUTTER TUBEX® for steel pipes

- Heavy-duty pipe cutter with 3 cutting wheels
- Ideal for working in confined, hard-to-reach places, since the cutter does not need to be turned through 360°
- For steel pipes (in sizes 2" and 4", by exchanging the cutting wheels, may also be used for cast iron or stainless steel pipes)
- Frame in malleable cast steel, size 1.1/4" forged
- With elastic feed using especially-installed spring system (size 2")
- Spindle protected by sleeve extension
- Stove enamelled blue, spindle gun-metal finished

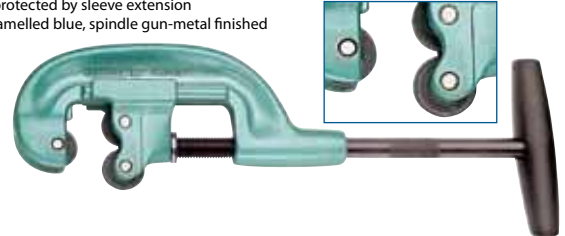

Code	No.	Size	Ø mm	↔ (mm)	↕	↔
4553260	222012	1/8-1.1/4"	10-42	275	1.2	1
4537060	222020	1/8-2"	10-60	380	2.7	1
4553420	222040	1.1/4-4"	42-114	520	4.8	1

223

PIPE CUTTER TUBEX® for SML and cast iron pipes

- Heavy-duty pipe cutter with 3 cutting wheels
- Ideal for working in confined, hard-to-reach places, since the cutter does not need to be turned through 360°
- For cast iron pipes (by exchanging the cutting wheels, may also be used for steel and stainless steel pipes)
- Frame in malleable cast steel
- With elastic feed using especially-installed spring system (size 2")
- Spindle protected by sleeve extension
- Stove enamelled blue, spindle gun-metal finished

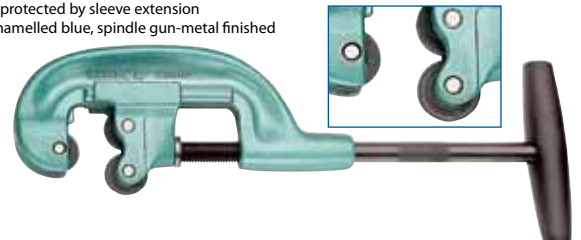

Code	No.	Size	Ø mm	↔ (mm)	↕	↔
4625190	223020	1/8-2"	10-60	380	2.7	1
4721070	223040	1.1/4-4"	42-114	520	4.8	1

E 220 - E 223

SPARE PARTS

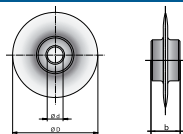

Code	No.	Ø D	b	Ø d	↕	↔
4503670	220212	25	14	7,5	13	1
Cutting wheel for steel 1/8-1.1/4"						
4503750	220220	32	19	9,0	28	1
Cutting wheel for steel 1/8-2"						
1524038	220221	32	19	9,0	28	1
Cutting wheel for niro 1/8-2"						
4552960	221220	32	19	9,0	40	1
Cutting wheel for cast iron 1/8-2"						

Code	No.	Ø D	b	Ø d	↕	↔
4503830	220240	41	19	9,0	38	1
Cutting wheel for steel 1.1/4-4"						
1516884	220241	41	19	9,0	40	1
Cutting wheel for niro 1.1/4-4"						
4553180	221240	41	19	9,0	64	1
Cutting wheel for cast iron 1.1/4-4"						
4552370	220612				8	1
Wheel and pressure roller bolt 1/8-1.1/4"						
4552450	220620				15	1
Wheel bolt 1/8-2"						
4552530	220640				19	1
Wheel and pressure roller bolt 1.1/4-4"						



PIPE CUTTERS FOR STAINLESS STEEL PIPES

218

HEAVY-DUTY PIPE CUTTER for stainless steel pipes

- Easy cutting due to ball-bearing pressure rollers and cutting wheels
- Body in pressure-cast aluminium
- Cutting wheel with high service life
- No. 218030 with quick-release

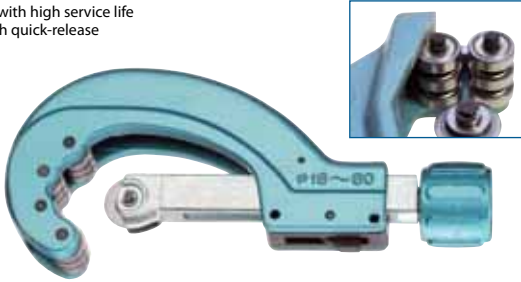

Code	No.	Ø mm	l mm	W mm	H mm
1949748	218010	4-32	140	310	1
1949764	218020	5-45	170	390	1
1949772	218030	16-60	225	1100	1

E 218

SPARE PARTS

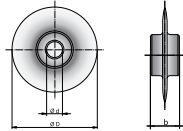

Code	No.	Ø D	b	Ø d	W	H
1949780	218210 Cutting wheel for 218010+020	22.0	7.9	5	5	1
1949799	218230 Cutting wheel for 218030	27.5	7.9	5	7	1
1974025	218610 Spare bolt for 218010+020				3	1
1974033	218630 Spare bolt for 218030				5	1

224

RATCHET PIPE CUTTER NIRO for stainless steel pipes

- Low space requirements, therefore highly suitable for working on vehicle exhaust gas systems
- Body in zinc-plated pressure-cast aluminium
- Easy handling via ratchet feed with automatic infeed of the cutting wheel with every rotation
- For pipes 16 - 35 mm Ø (size 1) or 35 - 66 mm Ø (size 2)
- Cutting wheel made from high-alloy stainless steel, with high service life
- One spare cutting wheel in addition



Code	No.	Ø mm	l mm	W mm	H mm
1600877	224011	16-35	260	930	1
1600885	224021	25-66	360	1710	1

E 224

SPARE PARTS

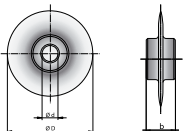

Code	No.	Ø D	b	Ø d	W	H
1621440	224211 Cutting wheel size 1 + 2	26	6.3	4.8	7	1
1621459	224611 Wheel bolt size 1 + 2				3	1

225

PIPE CUTTER NIRO for stainless steel pipes

- Special compact design
- Body in pressure-cast zinc
- With retractable deburring tool, spare cutting wheel in handle
- Cutting wheel with high service life
- Enamelled silver



Code	No.	Ø mm	l mm	W mm	H mm
1568418	225011	6-35	185	435	1

E 225

SPARE PARTS

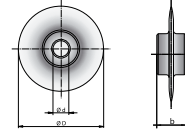

Code	No.	Ø D	b	Ø d	W	H
2304414	225211 Cutting wheel for stainless steel	20	4.8	5,1	5	1
1467840	225610 Wheel bolt				3	1

2303

PIPE CUTTER QUICK AUTOMATIC NIRO for stainless steel pipes

- Body in pressure-cast zinc
- Cutting wheel made from high-alloy stainless steel, with high service life
- Automatic infeed by plate springs
- Enamelled silver



Gr. 1

Gr. 2

Code	No.	Size	Ø mm	l mm	W mm	H mm
1154990	230311	1	4-32	165	430	1
1154850	230321	2	13-65	275	1420	1

E 2303

SPARE PARTS

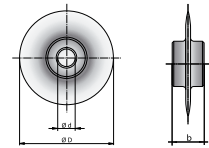

Code	No.	for size	Ø D	b	Ø d	W	H
1154710	230411 Cutting wheel for stainless steel	1	20	4.8	5,1	5	1
1154680	230421 Cutting wheel for stainless steel	2	32	9.9	6,1	18	1
1154656	230611 Wheel bolt					3	1
1154540	230621 Wheel bolt					3	1

PIPE DEBURRING REAMER FOR STAINLESS STEEL PIPES

2325

PIPE DEBURRING REAMER for stainless steel pipes

- For internal and external deburring of stainless steel pipes
- Aluminium body
- Hardened taper section with 40 deburring blades



Code	No.	Ø mm	l mm	W mm	H mm
1857681	232501	8-35	60	180	1
1419684	232500	10-56	85	420	1



PIPE CUTTERS FOR COPPER PIPES

225

PIPE CUTTER for copper pipes

- ▶ Special compact design
- ▶ Body in pressure-cast zinc
- ▶ For copper, brass, and light-alloy pipes, PVC hard plastic and plastic-coated pipes, thin-walled steel pipes, (precision steel and hydraulic pipes), composite pipes
- ▶ With retractable deburring tool, spare cutting wheel in handle
- ▶ Enamelled blue



Code	No.	Ø mm	l mm	W mm	H mm
1460412	225010	6-35	185	435	1

E 225

SPARE PARTS

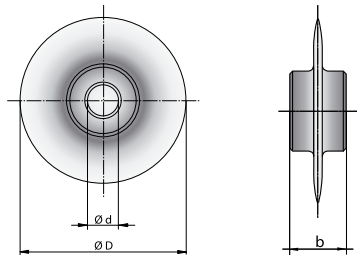

Code	No.	Ø D	b	Ø d	W mm	H mm
1467824	225210 Cutting wheel	19.5	4.8	5	5	1
1467840	225610 Wheel bolt				3	1

228

PIPE CUTTER for copper pipes

- ▶ With high-speed adjustment feature
- ▶ Frame in light-alloy
- ▶ No. 228020 with retractable deburring knife and spare cutting wheel in the handle
- ▶ Cutting wheels for plastic pipes can be used



228020

Code	No.	Ø mm	l mm	W mm	H mm
4629770	228020	6-50	175	375	1
4629930	228055	50-140	350	1345	1

E 228

SPARE PARTS

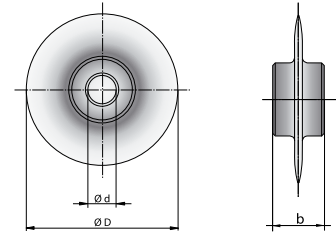

Code	No.	Ø D	b	Ø d	W mm	H mm
4630000	228220 Cutting wheel for copper	18	6.1	4.9	4	1
4630190	228230 Cutting wheel for copper	23	11.0	8.0	11	1
4632130	227620 Wheel bolt for 227020 + 228020				3	1
4632210	227630 Wheel bolt for 227055 + 228055				10	1

229

PIPE CUTTER for copper pipes

- ▶ Body in pressure-cast zinc
- ▶ With mill in handle
- ▶ Stove enamelled blue



Code	No.	Ø mm	l mm	W mm	H mm
4503910	229010	3-35	185	470	1

E 229

SPARE PARTS

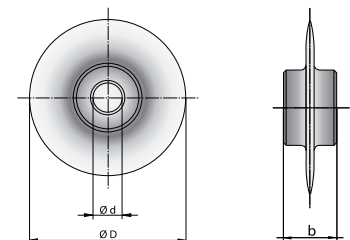

Code	No.	Ø D	b	Ø d	W mm	H mm
4504640	230210 Cutting wheel	20	4.8	5.1	5	1
4537220	229610 Wheel bolt				3	1



**2300****PIPE CUTTER QUICK AUTOMATIC**

- Tool body in pressure-cast zinc
- Cutting wheels in chrome-alloyed stainless steel
- For cutting copper, brass, and light-alloy pipes, PVC hard plastic and plastic-coated (WICU®) pipes, thin-walled steel pipes, (e.g. Ermeto pipes), composite pipes, stainless steel pipes
- With automatic infeed by plate springs, retractable deburring knife
- Stove enamelled blue

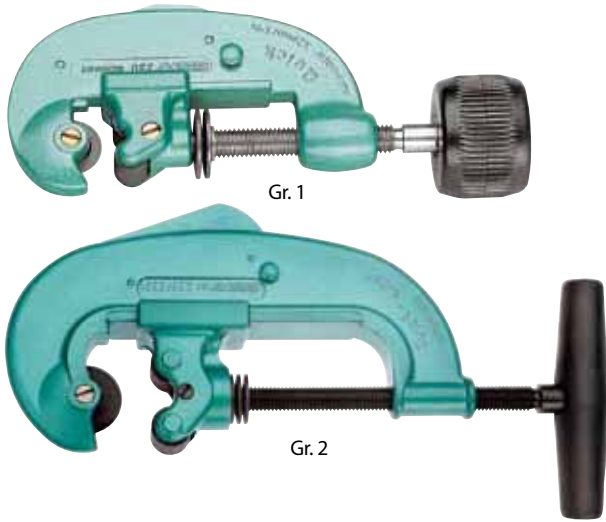

Code	No.	Size	Ø mm	l-mm	l	l
4504050	230010	1	4-32	165	435	1
4504130	230020	2	13-65	275	1460	1

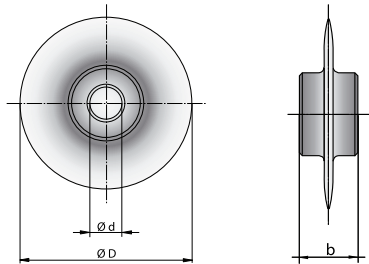
E 2300**SPARE PARTS**

Code	No.	for size	Ø D	b	Ø d	l	l
4504640	230210	1	20	4.8	5,1	5	1
4504800	230220	2	32	9,9	6,1	18	1
1154656	230611	1				3	1
1154540	230621	2				3	1

231**MINIATURE PIPE CUTTER MINI-QUICK**

- Particularly suitable for barely accessible places
- For copper, brass, and light-alloy pipes, thin-walled steel pipes (precision steel and hydraulic pipes)
- Body in pressure-cast zinc
- Cutting wheel in chrome-alloyed stainless steel
- Stove enamelled blue

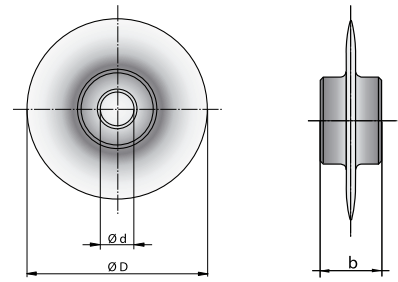

Code	No.	Ø mm	l-mm	l	l
4504560	231000	4-16	50	125	1

E 231**SPARE PARTS**

Code	No.	Ø D	b	Ø d	l	l
4504640	230210	20	4.8	5,1	5	1
1154710	230411	20	4.8	5,1	5	1
1154656	230611				3	1

PIPE DEBURRING REAMER FOR COPPER PIPES**2320****PIPE DEBURRING REAMER**

- For internal and external deburring of thin-walled pipes
- Plastic body



Code	No.	Ø mm	l-mm	l	l
1439510	232001	4-32	45	30	1

CALIBRATING TOOLS FOR COPPER PIPES**239****CALIBRATING TOOL**

- For exact calibrating of tube ends
- For semi-hard and soft copper pipes
- Gun-metal finish



Code	No.	Ø mm	l	l
4506260	239010	10 x 1	62	1
4506340	239012	12 x 1	67	1
4506420	239015	15 x 1	138	1
4506500	239018	18 x 1	179	1
4506690	239022	22 x 1	270	1
4506770	239028	28 x 1,5	485	1

**922****487**



PIPE CUTTERS FOR PLASTIC PIPES

2261

SHEARS SET for plastic pipes

- To cleanly cut hard and soft plastic pipes, rubber hoses with or without textile reinforcement, and as well as various plastic profiled sections, such as cable ducts, for example
- Contains form blocks for 16, 19 and 25 mm pipes, 1 prism for profiles and 1 angle stop adjustable up to 45°
- Delivery in plastic case no. 226090

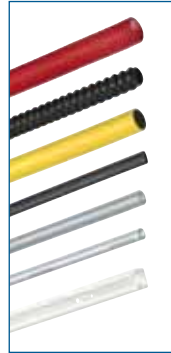

Code	No.		
1637983	226100	1.1	1

E 2261

PARTS

Code	No.	Description		
1637975	226000	Shears for plastic pipes	320	1
1637991	226001	Prism block 90°	36	1
1638009	226002	Form block 16 + 19 mm	29	1
1638017	226003	Form block 25 mm	31	1
1638025	226004	Angle support	69	1
1680137	226005	Spare knife	50	1
1680145	226006	Standard support	50	1
1637967	226090	Plastic case for 226100	570	1

2265

PIPE CUTTER for plastic pipes

- Body in pressure-cast aluminium
- For clean and chip-free cutting of PVC pipes, synthetic-resin pipes, water hose, etc.
- Cutting knife driven via ratchet feed
- Easy replacement of the cutting knife no. 226635 without dismantling the cutter
- Enamelled blue



Code	No.	up to Ø mm	↳mm↳		
1220470	226535	35	195	680	1

E 2265

SPARE PARTS

Code	No.		
1231162	226635	30	1
Spare knife for 226535			

2268

PIPE SHEARS for plastic pipes

- Smooth and accurate cutting, one hand operation
- Suitable to cut plastic pipes PE, PP, PVC, PVDF, PB and VPE
- Also suitable for rubber hoses
- Body from aluminium

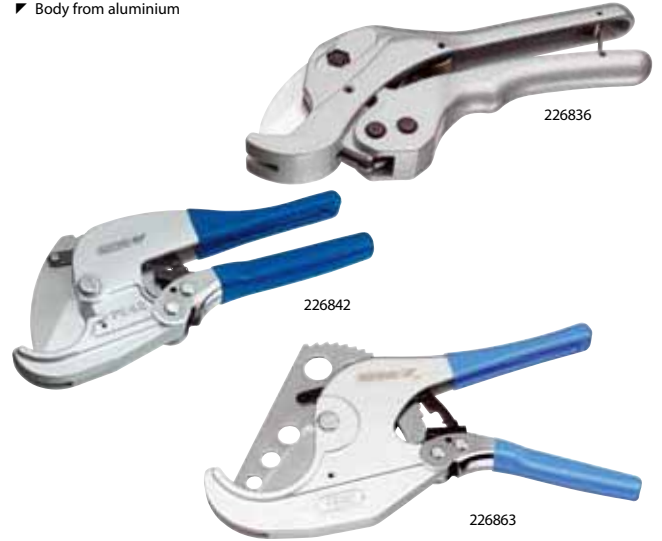

Code	No.		up to Ø mm	↳mm↳		
2304465	226836		36	195	280	1
1746073	226842		42	225	500	1
1952684	226863		63	275	650	1

E 2268

SPARE PARTS

Code	No.		
2312263	226936	50	1
Spare knife for 226836			
1952692	226942	80	1
Spare knife for 226842			
1952706	226963	160	1
Spare knife for 226863			

227

PIPE CUTTER for plastic pipes

- With high-speed adjustment feature
- Frame in light-alloy
- No. 227020 with fold-out deburring knife and spare cutting wheel in the handle
- Cutting wheels for copper pipes no. 228220 + 228230 can be used



Code	No.	Ø mm	↳mm↳		
4629260	227020	6-50	175	375	1
4629180	227055	50-140	350	1345	1

E 227

SPARE PARTS

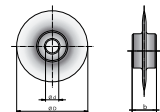

Code	No.	Ø D	b	Ø d		
4629420	227220	22	6.1	4.9	5	1
Cutting wheel for 227020						
4629690	227255	53	11.0	8.0	20	1
Cutting wheel for 227055						
4632130	227620				3	1
Wheel bolt for 227020 + 228020						
4632210	227630				10	1
Wheel bolt for 227055 + 228055						



FLARING TOOLS

2333

FLARING TOOL SET BOERDEX®

- For flaring copper and light-alloy pipes of various hardnesses
 - Body in pressure-cast zinc, stove enamelled blue
 - Flange cone 90° hardened
 - Clamping jaws made from steel, smooth inside, phosphated
 - Opening angle 90° = 45° angled from pipe
 - With cone no. 233200 for 180° flaring = 90° angle from pipe
 - Delivery in sheet steel case no. 233909
- Flaring tools for brake lines see no. 234



Code	No.		
4555550	233301 for metric pipes 4, 4.75, 6, 8, 10, 12, 14 mm 1 basic frame No. 233000 1 clamping jaw 4-14 mm No. 233101 1 pipe cutter 4-32 mm No. 230010 1 cone 180° No. 233200 1 sheet steel case No. 233909	2.9	1
1919733	233309 for metric pipes 15, 16, 17, 18, 19 mm 1 basic frame No. 233000 1 clamping jaw 15-19 mm No. 233109 1 pipe cutter 4-32 mm No. 230010 1 cone 180° No. 233200 1 sheet steel case No. 233909	2.9	1
4556280	233307 for inch pipes 3/16, 1/4, 5/16, 3/8, 7/16, 1/2, 5/8, 3/4" 1 basic frame No. 233000 1 clamping jaw 3/16-3/4" No. 233107 1 pipe cutter 4-32 mm No. 230010 1 cone 180° No. 233200 1 sheet steel case No. 233909	3.0	1

2330

FLARING TOOL BOERDEX®

- For flaring copper and light-alloy pipes of various hardnesses
 - Body in pressure-cast zinc, stove enamelled blue
 - Flange cone 90° hardened
 - Clamping jaws made from steel, smooth inside, phosphated
 - Opening angle 90° = 45° angled from pipe
- Flaring tools for brake lines see no. 234

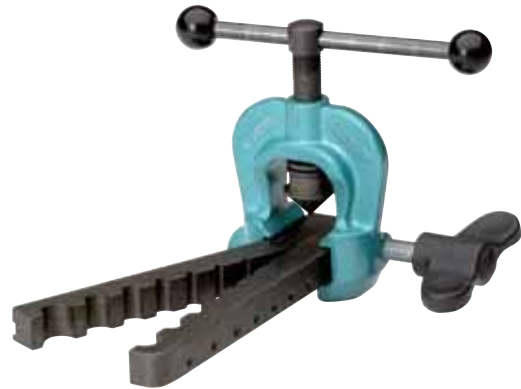

Code	No.		
4537300	233001 for metric pipes 4, 4.75, 6, 8, 10, 12, 14 mm 1 basic frame No. 233000 1 clamping jaw 4-14 mm No. 233101	1.4	1
1919725	233009 for metric pipes 15, 16, 17, 18, 19 mm 1 basic frame No. 233000 1 clamping jaw 15-19 mm No. 233109	1.4	1
4554660	233007 for inch pipes 3/16, 1/4, 5/16, 3/8, 7/16, 1/2, 5/8, 3/4" 1 basic frame No. 233000 1 clamping jaw 3/16-3/4" No. 233107	1.5	1

E 233

PARTS



233101-109



233200

Code	No.		
4554150	233000 Flaring tool	660	1
4554820	233101 Clamping jaw 4-14 mm	620	1
1885162	233109 Clamping jaw 15-19 mm	560	1
4555470	233107 Clamping jaw 3/16" - 3/4"	680	1
4505450	233200 Cone for 180° flaring (= 90° angled from pipe)	15	1
4504050	230010 Pipe cutter QUICK AUTOMATIC 4-32 mm	435	1
4556360	233909 Sheet steel case	1040	1



www.gedore.com

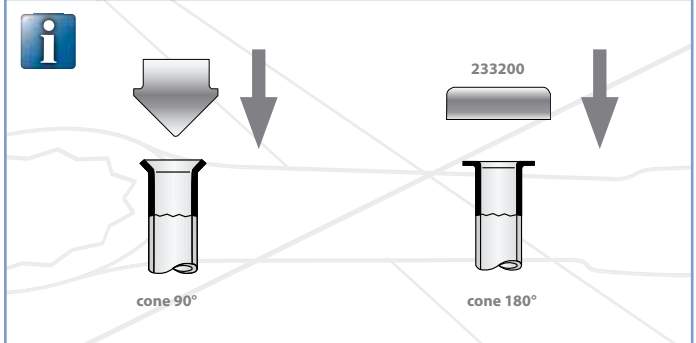



234

DOUBLE FLARING TOOL SET

- ✔ For standard-compliant (DIN 74234) double flaring tools on brake lines, coolant lines, hydraulic and pneumatic pipes with a wall thickness of 0.7 to 1.0 mm
- ✔ Body in tempered cast iron GTW 40, stove enamelled blue
- ✔ Clamping jaws made from steel, smooth inside, phosphated
- ✔ Complete set for metric and/or inch pipes
- ✔ Delivery in sheet steel case no. 234901



Code	No.	3.0	1
4505530	234001 for metric pipes 1 basic frame No. 234000 1 clamping jaw metric No. 234101 6 cones 4,75-10 mm No. 234204-234210 2 cones, No. 234790 + 234801 1 miniature pipe cutter 4-16 mm No. 231000 1 pipe deburring reamer 4-32 mm No. 232001 1 sheet steel case No. 234901	3.0	1
4537570	234002 for inch pipes 1 basic frame No. 234000 1 clamping jaw inch No. 234102 4 cones 3/16-3/8" No. 234303-234306 2 cones No. 234790 + 234802 1 miniature pipe cutter 4-16 mm No. 231000 1 pipe deburring reamer 4-32 mm No. 232001 1 sheet steel case No. 234901	3.0	1
4662980	234013 for metric + inch pipes 1 basic frame No. 234000 2 clamping jaws No. 234101 + 234102 6 cones 4,75-10 mm No. 234204-234210 4 cones 3/16-3/8" No. 234303-234306 3 cones No. 234790 + 234801-802 1 miniature pipe cutter 4-16 mm No. 231000 1 pipe deburring reamer 4-32 mm No. 232001 1 sheet steel case No. 234901	4.2	1

E 234

PARTS



Code	No.	880	1
4556440	234000 Basic frame	880	1
4556520	234101 Clamping jaw metric	760	1
4556600	234102 Clamping jaw inch	760	1
4556790	234204 Cone 4,75 mm for flare types E + F	18	1
4556870	234205 Cone 5 mm for flare types E + F	18	1
4556950	234206 Cone 6 mm for flare types E + F	18	1
4557090	234208 Cone 8 mm for flare types E + F	18	1
4557170	234209 Cone 9 mm for flare types E + F	18	1
4557250	234210 Cone 10 mm for flare types E + F	18	1
4557330	234303 Cone 3/16" for flare types E + F	18	1
4557410	234304 Cone 1/4" for flare types E + F	18	1
4557680	234305 Cone 5/16" for flare types E + F	18	1
4557760	234306 Cone 3/8" for flare types E + F	18	1
4557840	234790 Cone (adjustment gauge) for flare types 90° + 180° and cone 90° + flare E	16	1
4557920	234801 Cone (adjustment gauge), metric, 180°, for flare types E + F	11	1
4558060	234802 Cone (adjustment gauge), inch, 180°, for flare types E+F	11	1
4504560	231000 Pipe cutter MINI-QUICK, 4-16 mm	125	1
1439510	232001 Pipe deburring reamer 4-32 mm	30	1
4558140	234901 Sheet steel case	1040	1

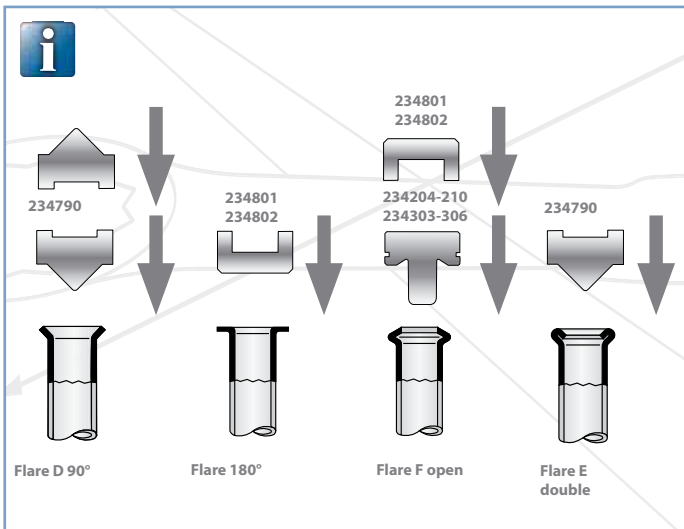

923

487

**INSTALLATION TOOLS****312****VALVE HOLDER VENTI-QUICK**

- In aluminium
- Drain valve holder and screw-in wrench for eccentric and standard valves 1.1/4"
- Usable from top or bottom



Code	No.	↳mm↳	↕	📦	
4508980	312000	120	260	1	92.01

**314****CORNER VALVE SOCKET WRENCH**

- Chrome-vanadium steel 31CrV3, hardened, zinc-plated
- For surface-protective assembling of all usual corner valves
- With chamfered driving edges
- 1/2" internal square drive



Code	No.	↳mm↳	↕	📦	
1147471	314000	82	150	1	

3170**INSTALLATION WRENCH**

- For bathroom fittings attachment (stud screws) M10 or M12
- Open end spanner size 17x19 mm



Code	No.	for stud screws	Size	↳mm↳	↕	📦
4509360	317000	M10	17x19 mm	220	260	1
4609310	317012	M12	17x19 mm	220	315	1

3175**INSTALLATION WRENCH**

- For corner valves and bathroom fittings attachment (stud screws) M10 or M12
- With reversible ratchet ring wrench size 17 mm or 19 mm and open ended spanner size 19 mm with special jaw design
- Chrome-vanadium steel 31CrV3, matt chrome-plated



Code	No.	for stud screws	Size	↳mm↳	↕	📦
4509520	317500	M10	17x19 mm	235	270	1
4609580	317512	M12	19x19 mm	235	260	1

3171**STUD SCREW WRENCH**

- For bathroom fittings attachment (stud screws) M6, M8, M10, M12
- With pivotable thread insert
- Nickel-plated



Code	No.	↳mm↳	↕	📦	
4509440	317100	220	300	1	

3173 - 3174**STUD SCREW INSERTER**

- Self-gripping
- For the fast and easy insertion and removal of studs, bolts, etc.
- No. 3173 with exchangeable hexagon drive
- No. 3174 with SDS-plus holder



Code	No.	Size	↕	📦	
1523171	317306 with hexagon drive	M6	130	1	
1523198	317308 with hexagon drive	M8	130	1	
1523201	317310 with hexagon drive	M10	130	1	
1523228	317312 with hexagon drive	M12	130	1	
1523236	317406 with SDS-plus holder	M6	130	1	
1523244	317408 with SDS-plus holder	M8	130	1	
1523252	317410 with SDS-plus holder	M10	130	1	
1523260	317412 with SDS-plus holder	M12	130	1	





BASIN WRENCHES

315

BASIN PLIERS

- ✔ Chrome-vanadium steel 31CrV3, drop-forged
- ✔ Applicable from size 13 to 36 mm
- ✔ Enamelled blue



Code	No.	l-mm	mm	kg
4509010	315000	270	565	1

316

BASIN WRENCH

- ✔ Chrome-vanadium steel 31CrV3
- ✔ With pivoted hook for right or left hand operation
- ✔ For use up to size 36 mm
- ✔ Enamelled blue

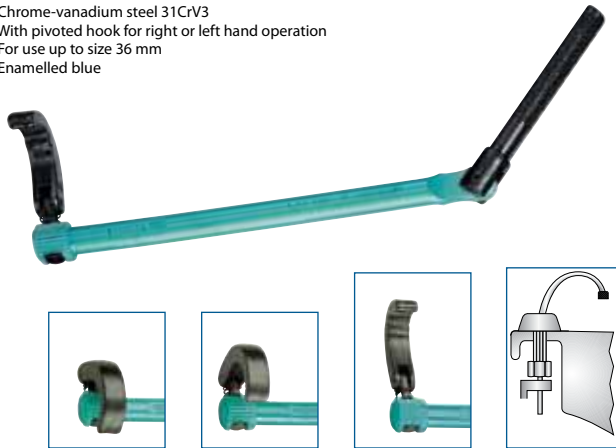

Code	No.	l-mm	mm	kg
4509280	316000	235	500	1

3165

BASIN WRENCH

- ✔ For single lever taps
- ✔ With 13 mm hexagon drive
- ✔ With adaptors for 10, 11, 14 mm



Code	No.	l-mm	mm	kg
4624110	316500	260	300	1

3166

UNIVERSAL BASIN WRENCH

- ✔ Suitable for many purposes
- ✔ For use up to size 36 mm
- ✔ For single lever taps
- ✔ With 13 mm hexagon drive
- ✔ Adaptor with cross handle and 1/2" square drive
- ✔ For further accessories see no. 318100

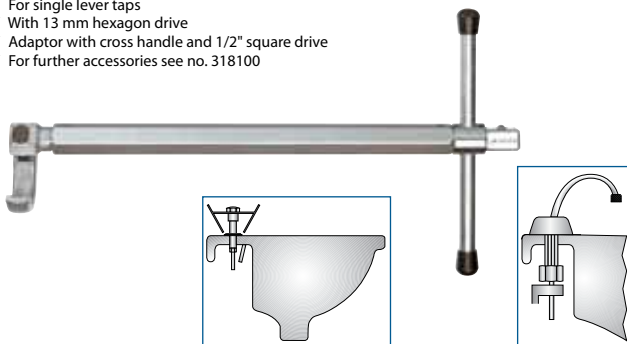

Code	No.	l-mm	mm	kg
4645970	316600	310	450	1

3181

SANITARY INSTALLATION SET

- ✔ Can be used for nearly all works in the bathroom
- ✔ Contains the most common tools used when installing taps of all usual models, corner valves, washbasin mountings or fittings, water connections, toilet seat fittings, screw hooks etc.
- ✔ Delivery in sheet steel case no. 318190

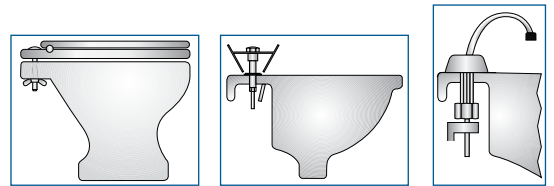

Code	No.	kg	kg
4722710	318100	2.760	1

1 basin wrench No. 316600 with hexagon extension 90 mm
 3 socket wrenches 10, 11, 14 mm with adaptor
 1 insertion hook for toilet seat fittings
 1 ratchet with coupler 1/2"
 1 installation wrench
 1 miniature pipe cutter 4-16 mm
 1 deburring reamer 4-32 mm

E 3181

PARTS

Code	No.	Description	kg	kg
4698310	316601	Hexagon tube 13 mm Ø, 240 mm	190	1
4721740	316602	Pawl 13 mm Ø	115	1
4721820	316603	Cross handle adaptor with 1/2" square drive	75	1
4721900	316604	Cross handle	90	1
4722040	316605	Adaptor for socket wrenches 1/2"	50	1
4722120	316606	Hexagon extension 90 mm	220	1
4722200	316607	Insertion hook for toilet seat fittings	125	1
4722390	316608	Socket wrench 10 mm	55	1
4722470	316609	Socket wrench 11 mm	55	1
4722550	316610	Socket wrench 14 mm	60	1
4513120	380200	Ratchet 1/2"	420	1
1469029	380210	Square connector 1/2"	40	1
4509520	317500	Installation wrench M10, 17x19 mm	270	1
4504560	231000	Pipe cutter MINI-QUICK, 4-16 mm	125	1
1439510	232001	Pipe deburring reamer 4-32 mm	30	1
4722980	318190	Sheet steel case	920	1



PLUMBING WRENCHES

320

WRENCH FOR PLUMBING FITTINGS

- With pawl clamp
- With exchangeable plastic jaws no. 320100, width 8 mm
- For nickel-plated and chrome-plated fittings
- Chrome-vanadium steel 31CrV3, hardened, chrome-plated
- Handle enamelled blue



Code	No.	mm	mm	mm	mm	
4509600	320000	65	45	275	720	1
4540520	320100				10	1

321

QUICK-CLAMP FITTINGS WRENCH FIXO-SPANN®

- Quick adjustment by ratchet and pawl clamp
- With exchangeable protective brass jaws no. 321100, width 10 mm
- For nickel-plated and chrome-plated fittings
- Quality steel, hardened, nickel-plated



Code	No.	mm	mm	mm	mm	
4509790	321000	65	45	290	790	1
4540600	321100				25	1

322

PLUMBING WRENCH

- From aluminium
- For special surface protection
- Easy handling due to quick-release
- Load capacity max. 100 N·m

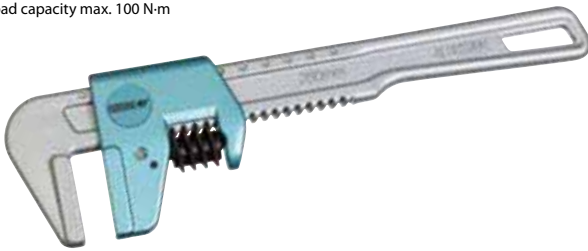

Code	No.	mm	mm	mm	mm	
1949802	322000	73	35	260	280	1

324

QUICK-CLAMP WRENCH

- Quick adjustment by ratchet and pawl clamp
- Jaw width 15 mm
- Chrome-vanadium steel, zinc-chromated
- Handle enamelled blue

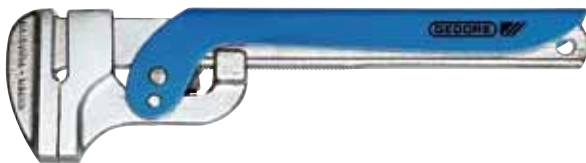

Code	No.	mm	mm	mm	mm	
4624970	324000	60	35	250	640	1

328

GRIP WRENCH

- For secure, damage-free gripping and holding of pipes
- With exchangeable special plastic jaws no. 328100, 15 mm wide
- In malleable cast iron
- Stove enamelled blue



Code	No.	mm	mm	mm	mm	
4510100	328000	16-50	300	615		1
4609660	328100				30	1

329

SPECIAL SIPHON PLIERS

- For tightening and removing screwed PVC pipe joints with round union nuts
- With lap joint and three locking positions, jaw width 10 mm
- No. 329001 with plastic jaws for special surface protection
- Stove enamelled blue

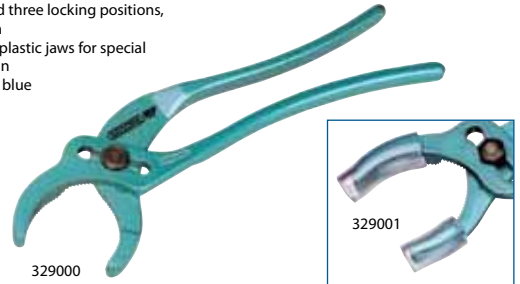

Code	No.	mm	mm	mm	mm	
4510290	329000	20-65	230	300		1
1984381	329001	20-65	230	300		1

TAP RESEATING TOOLS

365

TAP RESEATING TOOL

- Cylindrical pattern
- For the plane milling of leaky water-tap valves up to 1" without removing the tap



Code	No.	mm	mm	
4511340	365001			330 1
		Basic tool, flat mills 3/8", 1/2", 3/4"		
4511420	365002			360 1
		Basic tool, flat mills 3/8", 1/2", 3/4", 1"		
4540870	365005			505 1
		Basic tool, flat mills 3/8", 1/2", 3/4" in plastic case		
4540950	365006			535 1
		Basic tool, flat mills 3/8", 1/2", 3/4", 1" in plastic case		

E 365

PARTS

Code	No.	mm	mm	
4610160	365100			300 1
		Basic tool, without mills and plastic case		
4610240	365101			5 1
		Flat mill 1/4"		
4610320	365103			5 1
		Flat mill 3/8"		
4610400	365105			5 1
		Flat mill 1/2"		
4610590	365107			15 1
		Flat mill 3/4"		
4625270	365110			25 1
		Flat mill 1"		
4610080	365090			205 1
		Plastic case		





STEPPED KEYS / VALVE SPANNER

376

STEPPED KEY

- For the installation and removal of valve nipples 3/8", 1/2", 3/4", 1", 1.1/4"
- Drive with 18 mm square

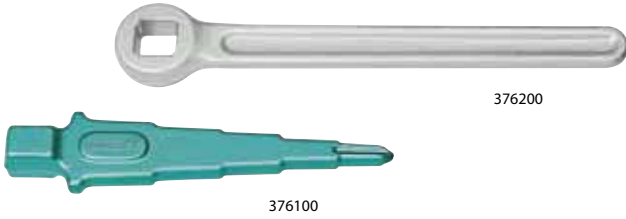

Code	No.	↕	📦
4512580	376000	630	1
Stepped key with handle			
4541250	376100	245	1
Stepped keys 3/8", 1/2", 3/4", 1", 1.1/4", enamelled blue			
4541330	376200	385	1
Handle with 18 mm square, 240 mm long, galvanized			

3785

PLUMBER'S WRENCH

- With 14 functions for tap extensions 3/8", 1/2", 3/4", 1"
- Depth up to 100 mm
- For the installation and removal of radiator valves and runback screwed unions
- For stud screws M6, M8, M10, M12 and for screw plugs 3/8", 1/2"
- Hexagon drive nut size 17, 22 mm
- Chrome-plated



Code	No.	↕	📦
4512820	378500	220 x 220	670
1			

379

COMBINATION STEPPED KEY

- With tommy bar, for nipples 3/8", 1/2" and 3/4", for the installation and removal of radiator valves
- For runback screwed unions 3/8" - 3/4" and tap extensions
- With pin, hexagon and bi-hexagon drive nut
- Chemically nickel-plated

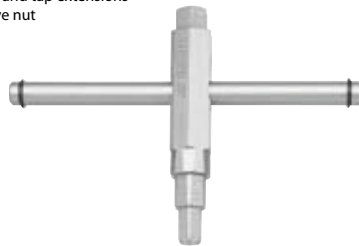

Code	No.	↕	📦
4541410	379100	100 x 155	220
1			

380

COMBINATION STEPPED KEY

- For the installation and removal of radiator valves, runback screwed unions 3/8" - 1" and short tap extensions
- With pin, hexagon and bi-hexagon nut drive
- 1/2" square drive
- Nickel-plated

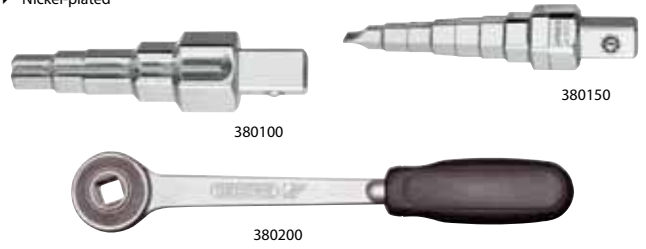

Code	No.	↕	📦
4512900	380000	555	1
Combi-stepped key No. 380100 with ratchet 1/2" No. 380200			
4630940	380001	555	1
Combi-stepped key No. 380150 with ratchet 1/2" No. 380200			
4513040	380100	135	1
Combi-stepped key with 5 steps			
4611130	380150	135	1
Combi-stepped key with 8 steps			
4513120	380200	420	1
Ratchet 1/2"			

3810

RADIATOR VALVE SPANNER

- Spanner for tightening and removing Euro-cone radiator compression fittings with A/F 30 mm cam lock and hex nuts
- Short, flat version with ratchet
- Ratchet facilitates tightening of straight and elbow compression fittings underneath radiators
- Head end socket for 1/2" extension. The extension is used as a handle and also provides higher torque
- Side socket for 1/2" extension for working with the ratchet in front of the radiator
- Socket for no. 3801 combination stepped key 3/4" radiator valve nipples

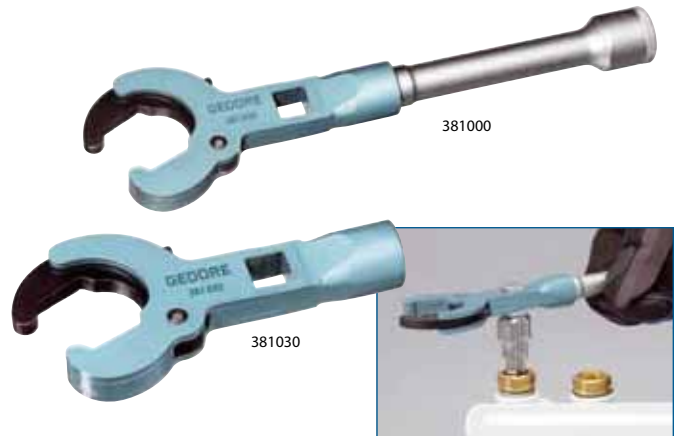

Code	No.	↕	📦
2233673	381000	390	1
1 Radiator valve spanner no. 381030			
1 Extension 1/2" no. 1990-5			
2233665	381030	225	1
Radiator valve spanner 30 mm			
4513040	380100	135	1
Combi-stepped key with 5 steps 3/8" - 1"			
6143860	1990-5	188	10
Extension 1/2" 125 mm			



45 P • 45 S • 45 B



138
-
139





SHEET METAL FORMING TOOLS

303

UNIVERSAL SEAMING PLIERS

- Forged
- Adjustable in six steps from 0-90°
- Jaws exchangeable
- Jaw width 60 mm



Code	No.	mm	mm	mm	mm
4508470	303060	60	265	785	1

304 - 305

SEAMING PLIERS

- Forged
- Jaw width 60 mm
- No. 304 Straight pattern
- No. 305 Bent pattern, bending angle 45°



304060



305060

Code	No.	mm	mm	mm	mm
4508550	304060	60	265	590	1
4508630	305060	60	265	630	1

340

GUTTER BENDING PLIERS

- Open pattern
- With adjustment screw
- Strong tube handles
- Enamelled blue



Code	No.	for gutters	mm	mm	mm
4510530	340006	6 x 40	640	3.080	1
4510610	340008	8 x 40	640	3.250	1

373

BORDERING PLIERS FOR WELDERS

- For making fillets on welding edges on pipe joints
- Adjustable in 5 steps from 0°-180°
- With hidden spring
- Zinc-plated



Code	No.	mm	mm	Jaw width	mm	mm	mm
4611050	373001	5.5	20	8-10	290	500	1
4511770	373002	6.0	30	10-20	300	540	1

384

SINGLE PUNCH

- With 3 cutting edges
- For sheet metal up to 1.5 mm thickness, VA sheet up to 1.2 mm thickness
- In chrome-alloyed stainless steel, hardened, gun-metal finish
- Sizes 28 and 33 mm see Double punch no. 385



Code	No.	mm	mm	mm
4513470	384035	35	270	1
4513550	384042	42	400	1

385

DOUBLE PUNCH

- With 3 cutting edges
- Size 28 x 33 mm
- For sheet metal up to 1.5 mm thickness, VA sheet up to 1.2 mm thickness
- In chrome-alloyed stainless steel, hardened, gun-metal finish
- Sizes 35 and 42 mm see Single punch no. 384



Code	No.	mm	mm	mm
4513630	385007	28-33	460	1

369

ANGLE REAMER

- Four- and five-edged, for reaming holes in sheet metal
- Also suitable for producing measurement openings for exhaust gas analysis
- Round shaft
- Enamelled blue, working surface bright metal



Code	No.	mm	mm	mm
4511500	369000	150	170	5

8532 • 8533



586



TIN SNIPS

420

TIN SNIPS

- ✔ Right hand cutting
- ✔ For long straight cuts
- ✔ Berlin pattern
- ✔ Ground cutting edges
- ✔ Sheet thickness max. 1.0 mm at strength 600 N/mm²
- ✔ Black varnished, handles blue epoxy coated



Code	No.	Execution	↳mm↳	↕	☒
4513710	420020	right hand cutting	225	330	1
4513980	420025	right hand cutting	250	470	1
4514010	420030	right hand cutting	300	740	1

421

HOLE CUTTING SNIPS

- ✔ For short straight and figure cuts (great radii)
- ✔ Polished cutting edges
- ✔ Sheet thickness max. 1.0 mm at strength 600 N/mm²
- ✔ Black varnished, handles blue epoxy coated



Code	No.	Execution	↳mm↳	↕	☒
4514280	421025	right hand cutting	250	490	1
4514360	421027	right hand cutting	275	520	1
4514440	421030	right hand cutting	300	610	1
4514520	421125	left hand cutting	250	500	1
4514600	421127	left hand cutting	275	520	1
4514790	421130	left hand cutting	300	620	1

422

IDEAL PATTERN SNIPS

- ✔ For straight continuous and figure cuts
- ✔ Polished cutting edges
- ✔ Sheet thickness max. 1.0 mm at strength 600 N/mm²
- ✔ Black varnished, handles blue epoxy coated



Code	No.	Execution	↳mm↳	↕	☒
4514870	422026	right hand cutting	260	510	1
4514950	422028	right hand cutting	280	580	1
4515090	422126	left hand cutting	260	565	1
4515170	422128	left hand cutting	280	600	1

423

PELICAN PATTERN SNIPS

- ✔ Right hand cutting
- ✔ For long straight continuous and figure cuts
- ✔ Polished cutting edges
- ✔ Sheet thickness max. 1.0 mm at strength 600 N/mm²
- ✔ Black varnished, handles blue epoxy coated



Code	No.	Execution	↳mm↳	↕	☒
4515250	423030	right hand cutting	300	730	1
4515330	423035	right hand cutting	350	850	1

8531

TIN SNIPS English pattern

- ✔ Left hand cutting
- ✔ With special strong cutting edges
- ✔ Polished cutting edges
- ✔ Handles blue epoxy coated



Code	No.	Execution	↳mm↳	↳inch↳	↕	☒
6757840	8531 8	left hand cutting	200	8	312	1
6757920	8531 10	left hand cutting	250	10	518	1
6758060	8531 12	left hand cutting	300	12	740	1

424 - 8524 SS

IDEAL PATTERN SNIPS

- ✔ For straight continuous and figure cuts
- ✔ With lever action
- ✔ Self-opening with installed spring, with lock
- ✔ Polished cutting edges
- ✔ Sheet thickness max. 1.2 mm at strength 600 N/mm²
- ✔ Model 8524 SS especially wear-resistant, extra hard
- ✔ Non-slip 2-component handles



Code	No.	Execution	↳mm↳	↕	☒
4515410	424026	right hand cutting	260	530	1
4515680	424126	left hand cutting	260	530	1
6756520	8524 SS	right hand cutting	260	581	1

425 - 8526 SS

FIGURE SNIPS

- ✔ For straight continuous and figure cuts
- ✔ With lever action
- ✔ Self-opening with installed spring, with lock
- ✔ Polished cutting edges
- ✔ Sheet thickness max. 1.2 mm at strength 600 N/mm²
- ✔ Model 8526 SS especially wear-resistant, extra hard
- ✔ Non-slip 2-component handles



Code	No.	Execution	↳mm↳	↕	☒
4515760	425026	right hand cutting	260	480	1
4515840	425126	left hand cutting	260	480	1
6756950	8526 SS	right hand cutting	260	547	1



ARC PUNCHES

5700

ARC PUNCH

- ▶ To DIN 7200 Form A
- ▶ For stamping out cardboard, leather, rubber, sealing materials and other soft materials
- ▶ Cutting edge hardened
- ▶ Shaft enamelled blue



Code	No.	Ø mm	Ø inch	↕	☒
4542300	570002	2	1/16	45	5
4542490	570003	3	1/8	45	5
4542570	570004	4	5/32	50	5
4542650	570005	5	3/16	70	5
4542730	570006	6	1/4	70	5
4542810	570007	7		90	5
4543030	570008	8	5/16	90	5
4543110	570009	9	11/32	90	5
4543380	570010	10	3/8	125	5
4543460	570011	11	7/16	130	5
4543540	570012	12	15/32	130	5
4543620	570013	13	1/2	165	5
4626590	570014	14	9/16	170	5
4543890	570015	15	19/32	180	5
4543970	570016	16	5/8	180	5
4544000	570017	17	21/32	230	5
4544190	570018	18	11/16	230	5
4544270	570019	19	3/4	240	5
4544350	570020	20	25/32	315	5
4546560	570021	21	13/16	315	1
4546670	570022	22	7/8	320	1
4545750	570023	23	29/32	375	1
4540440	570024	24	15/16	375	1
4618300	570025	25	1	400	1
4618490	570026	26	1.1/32	375	1
4618570	570027	27	1.1/16	475	1
4618650	570028	28	1.3/32	500	1
4618730	570029	29	1.1/8	450	1
4618810	570030	30	1.3/16	590	1
4619030	570031	31		580	1
4619110	570032	32	1.1/4	580	1
4619380	570033	33		660	1
4619460	570034	34	1.5/16	675	1
4619540	570035	35	1.3/8	690	1
4619620	570036	36		700	1
4619700	570037	37	1.7/16	700	1
4619890	570038	38	1.1/2	770	1
4619970	570039	39		770	1
4620040	570040	40	1.9/16	860	1
4620120	570041	41	1.5/8	860	1
4620200	570042	42		970	1
4620390	570043	43	1.11/16	980	1
4620470	570044	44		980	1

Code	No.	Ø mm	Ø inch	↕	☒
4620550	570045	45	1.3/4	1020	1
4620630	570046	46	1.13/16	1110	1
4620710	570047	47	1.7/8	1180	1
4620980	570048	48		1180	1
4621010	570049	49	1.15/16	1190	1
4621280	570050	50		1200	1
4621360	570055	55		1850	1
4621440	570056	56	2.3/16	1850	1
4621520	570058	58	2.1/4	2000	1
4621600	570059	59	2.5/16	2000	1
4621790	570060	60		2000	1
4621870	570064	64	2.1/2	2250	1
4621950	570065	65		2250	1
4622090	570070	70	2.3/4	4000	1
4622170	570075	75		4400	1
4622250	570080	80	3.1/4	4400	1
4622330	570090	90		5300	1
4622410	570100	100	4	8700	1

5703

SET OF ARC PUNCHES

- ▶ To DIN 7200 Form A
- ▶ For stamping out cardboard, leather, rubber, sealing materials and other soft materials
- ▶ Cutting edge hardened
- ▶ Shaft enamelled blue
- ▶ In plastic wallet no. 570390



Code	No.	↕	☒
1549472	570300 7 pieces, consisting of 1 piece each Arc punch 3, 5, 7, 8, 10, 11 and 13 mm	830	1
1549480	570301 8 pieces, consisting of 1 piece each Arc punch 3, 5, 7, 8, 10, 13, 16 and 19 mm	1120	1
1549499	570302 9 pieces, consisting of 1 piece each Arc punch 3, 5, 7, 8, 10, 13, 16, 19 and 20 mm	1450	1
1549502	570303 10 pieces, consisting of 1 piece each Arc punch 3, 5, 7, 8, 10, 13, 16, 19, 22 and 25 mm	1850	1
1549510	570304 8 pieces, consisting of 1 piece each Arc punch 3, 6, 8, 10, 12, 16, 20 and 25 mm	1470	1
1549758	570390 Plastic wallet, empty	110	1

➔

407 • 403

465





PIPE CLEANING TOOLS

840

FLEXIBLE PIPE CLEANING SHAFT

- ✔ For sink lines, drains, narrow pipes, etc. up to 40 mm Ø or up to 50 mm Ø
- ✔ Hot-dip galvanised spring-steel wire
- ✔ Wound in 2 layers
- ✔ With adjustable handle
- ✔ 2-blade claw





Code	No.	Ø mm	Length m	for pipe Ø		
4647910	840703	7	3.0	20-40	1.0	1
4657980	840705	7	5.0	20-40	1.3	1
4658010	840805	8	5.0	30-50	1.7	1
4648050	840807	8	7.5	30-50	2.5	1

841

FLEXIBLE PIPE CLEANING SHAFT

- ✔ For normal drain pipes up to 70 mm Ø resp. up to 100 or 200 mm Ø
- ✔ Hot-dip galvanised spring-steel wire
- ✔ Wound in 2 layers
- ✔ With replaceable crank
- ✔ 3-blade claw
- ✔ May also be used with extension shafts no. 842



Code	No.	Ø mm	Length m	for pipe Ø		
4648130	841005	10	5	50-70	3.1	1
4652160	841010	10	10	50-70	5.4	1
4658280	841205	12	5	60-100	4.5	1
4652240	841210	12	10	60-100	8.1	1
4648210	841510	15	10	100-200	11.0	1





842

EXTENSION SHAFT

- ✔ With coupling
- ✔ For pipe cleaning shafts no. 841



Code	No.	Ø mm	Length m	for pipe Ø		
4648480	842005	10	5	50-70	2.8	1
4652320	842205	12	5	60-100	4.2	1
4648560	842505	15	5	100-200	5.5	1



177 • 9850



349

130 • 133 D



**447
448**



860 - 861

HAND-TURNED PLUMBER'S SNAKE

- In rust-resistant sheet steel drum with hand crank and quick-action chuck
- With Flexikern®-shaft
- Model 860100 for drain pipes up to 50 mm Ø with shaft 7 mm, and drain sieve head
- Model 861000 for drain pipes up to 75 mm Ø with shaft 10 mm, coupling and interchangeable drill head

Code	No.	Ø mm	Length m	for pipe Ø up to	⚙️	📦
1467166	860100	7	7.5	50	3.2	1
1467190	861000	10	7.5	75	4.3	1

870

DRAIN PIPE CLEANER

- Compact design
- Electric motor 230 V, 0-600 rpm
- With Flexikern®-shaft
- By pressing the feed lever the shaft runs into the pipe, when the motor is reversed, the shaft retracts
- Shafts 8-10 mm interchangeable without disassembling
- Contains 1 piece each pipe cleaning heads no. 870901, 870902, 870903, 870904, 870905, 870906
- Optional available with plastic case

Code	No.	Ø mm	Length m	for pipe Ø	⚙️	📦
1467271	870080	8	7.5	40-50	11.9	1
1467298	870100	10	10.5	50-75	13.6	1

E 860 - E 861

PARTS

Code	No.	Description	⚙️	📦
1467174	860900	Flexikern®-shaft 7 mm x 7.5 m with drain sieve head	1800	1
1467204	861900	Flexikern®-shaft 10 mm x 7.5 m with coupling	2860	1
1467182	860902	Spare drain sieve head for shafts 7 mm	40	1
1467239	870802	Coupling for shafts 10 mm	20	1
1467247	870901	Drilling head 30 mm for shafts with coupling	50	1
1467255	870902	Swivel drilling head 25 mm for shafts with coupling	40	1
1467263	870903	Fork drilling head 40 mm for shafts with coupling	50	1

E 870

PARTS

Code	No.	Description	⚙️	📦
1467301	870608	Flexikern-shaft 8 mm x 7.5 m with coupling	2000	1
1467328	870611	Flexikern-shaft 10 mm x 10.5 m with coupling	3800	1
1467336	870801	Coupling for shafts 8 mm	22	1
1467239	870802	Coupling for shafts 10 mm	20	1
1467247	870901	Drilling head 30 mm for shafts with coupling	50	1
1467255	870902	Swivel drilling head 25 mm for shafts with coupling	40	1
1467263	870903	Fork drilling head 40 mm for shafts with coupling	50	1
1467344	870904	Spring milling head 16 mm	50	1
1467352	870905	Cutting knife 30 mm	40	1
1601849	870906	Milling tip 25 mm	40	1
1467816	870090	Plastic case	3100	1

Flexikern® shafts

All pipe cleaners are only as good as the shafts which are mounted. That is why our hand-turned plumber's snakes and pipe cleaners are only fitted out with the patented Flexikern® pipe cleaning shafts. Strong spring-steel wire is firmly wound and hardened around a 42-core special steel cable. This ensures an unattainable strength together with the right flexibility of the shaft. Under normal torque conditions the patented design keeps the shaft flexible. However when a further torque is set up, the shaft wrings itself around the stabilising steel cable core and, in turn, is stiffened into a unit.

95 • 100 • 119

450
455

Deviant packing units see article description.

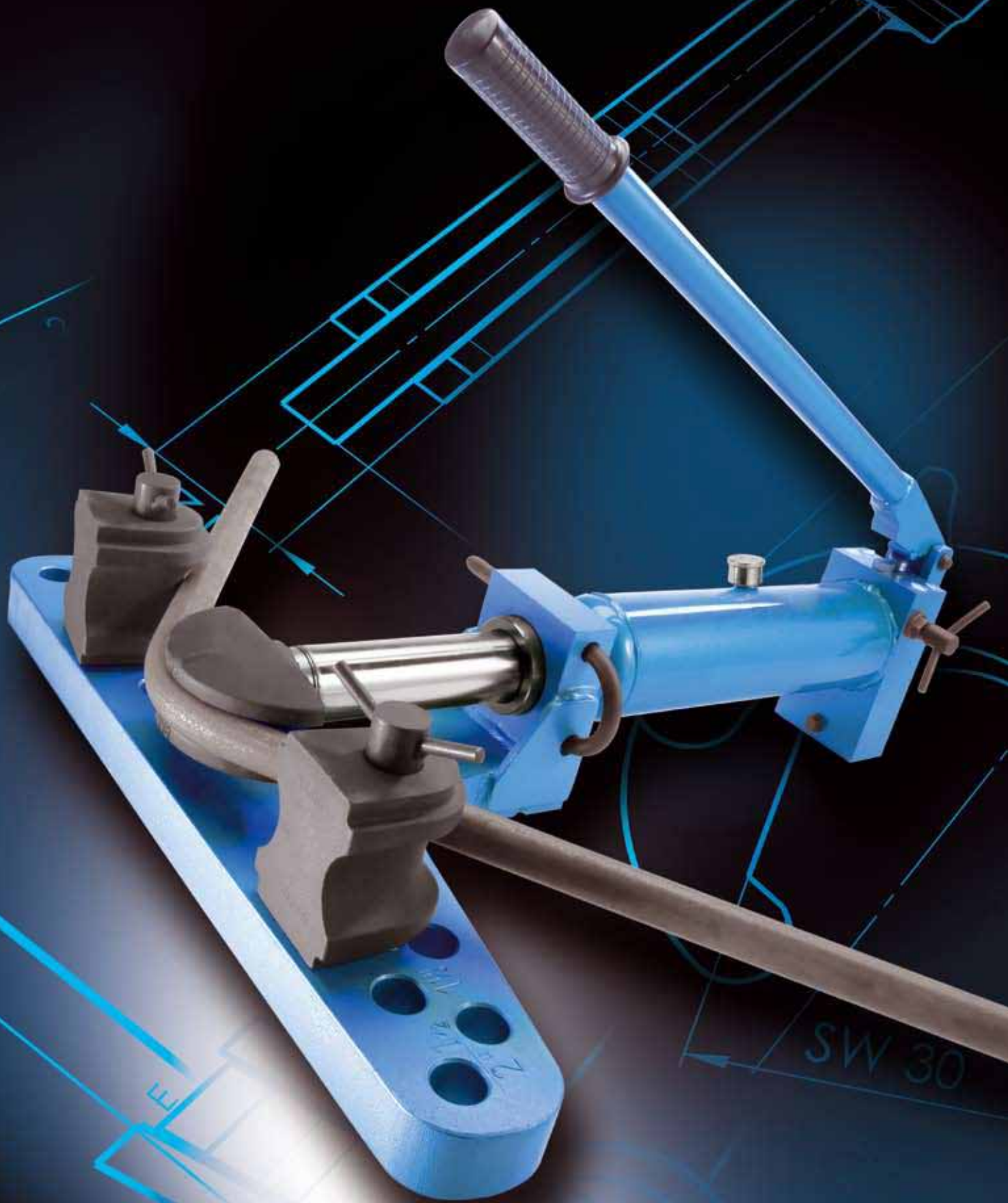



USEFUL INFORMATION

544

PIPE BENDING SPRINGS NO. 2450



544

PIPE BENDING PLIERS NO. 241-242



544 - 545

MANUAL PIPE BENDER – DRAW BENDING OPERATION

MANUAL BENDING TOOL SETS NO. 243



546

MANUAL BENDING TOOL SETS NO. 244



547

MANUAL BENDING TOOL SETS NO. 278



548 - 550

MANUAL BENDING TOOL SETS NO. 240



551

UNIVERSAL MANUAL PIPE BENDER NO. 276



551

MANUAL PIPE BENDER – PUSHING BENDING OPERATION NO. 2454-2456



552 - 553

PIPE BENDING MACHINES – DRAW BENDING OPERATION

PIPE BENDING MACHINES HYDRAULIC NO. 246



554

PIPE BENDING MACHINES HYDRAULIC NO. 249



555

PIPE BENDING MACHINES – PUSHING BENDING OPERATION NO. 255-260



556 - 561

ECCENTRIC ANGLE BENDERS NO. 280



562 - 564

RING BENDING MACHINE NO. 285



565

PIPE STRAIGHTENING TOOL NO. 286



565

HOW DO I FIND THE RIGHT BENDING TOOL

566 - 567





GEDORE Pipe bending systems

Features that make the difference...

- ✔ Durable quality for heavy professional use
- ✔ Gentle handling of workpieces
- ✔ Suitable for solving problems, a variety of materials and applications



Electrical limiter

- ✔ From simple bending pliers to an electro-hydraulic bending machine for 3" pipes
- ✔ Hand-operated, hydraulic and electro-hydraulic
- ✔ For the complete range of standard pipe grades
- ✔ Solving problems is our strength - Please ask us!



Useful information

You need to consider the following points when choosing your bending machine:

- ✔ Do you want to bend by hand?
- ✔ Do you want to use a vice?
- ✔ Is the machine to be hydraulically operated?
- ✔ Is the machine to be electrically operated, and if so at what voltage?

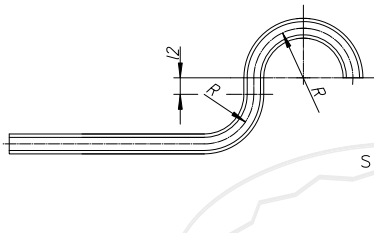

The following points also need to be taken into account; refer to adjacent sketch:

- ✔ The shape of the pipe to be bent (round-section, square-section, etc.)
- ✔ The outside diameter "D" of the pipe
- ✔ The wall thickness "S" of the pipe
- ✔ The pipe grade (e.g. steel, stainless steel, NF metals, etc.)
- ✔ The required bending angle (e.g. 90°, 180° ... etc.)
- ✔ Are bending radii "R" specified? (Example: $3 \times D = R$ - this corresponds to a 25 mm outside diameter pipe with a bending radius of 75 mm)
- ✔ Important: the radius is measured to the middle of the tube = neutral area
- ✔ Details of the length "L" of the overall pipe
- ✔ Are a number of bends to be made in succession? - If so, it is essential to state the distance between the pipe bends, "L2"
- ✔ Are there any specifications for the pipe or the finished pipe bends which go beyond the details listed here (e.g. in power-station construction, the food industry or similar)?

A more detailed overview of the possible uses of our pipe bending machines and tools is given in the next pages.

PIPE BENDING SPRINGS

2450

COPPER PIPE BENDING SPRING

- ✔ From 6.5 to 16 mm
- ✔ For soft copper pipes EN 1057



Code	No.	Ø mm	l mm	r mm	l mm
4573610	245006	6,5	250	55	5
4538460	245008	8,0	250	90	5
4538540	245010	10,0	275	110	5
4538620	245012	12,0	300	180	5
4538700	245015	15,0	300	200	5
4574180	245016	16,0	300	275	5

PIPE BENDING PLIERS

2415

PIPE BENDING PLIERS

- ✔ Sizes from 4.75 - 10 mm Ø up to 90°
- ✔ With 2 reversible bending forms 3/16" - 1/4" Ø (4,75 - 6 mm Ø) and 8 - 10 mm Ø
- ✔ For soft copper pipes EN 1057, all non-ferrous metal pipes as well as thin-walled precision steel pipes and brake lines
- ✔ Bright nickel-plated, handles PVC coated

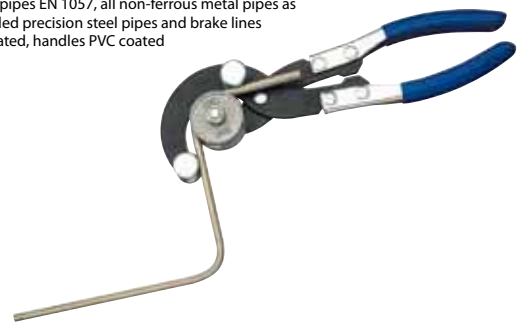

Code	No.	Ø mm	Ø inch	r mm	l mm	l mm
1442007	241500	4,75-10,0	3/16-3/8	260	580	1

E 2415

SPARE BENDING FORMER



Code	No.	Ø mm	Ø inch	r mm	l mm	l mm
1442910	241506	4,75-6,0	3/16-1/4	15	40	1
1442929	241510	8,0-10,0	5/16-3/8	15	40	1



2410

PIPE BENDING PLIERS

- ✔ Sizes from 4.75 to 12 mm Ø up to 180°
- ✔ For soft copper pipes EN 1057, non-ferrous metal pipes as well as thin-walled precision steel pipes and brake lines
- ✔ Stove enamelled blue

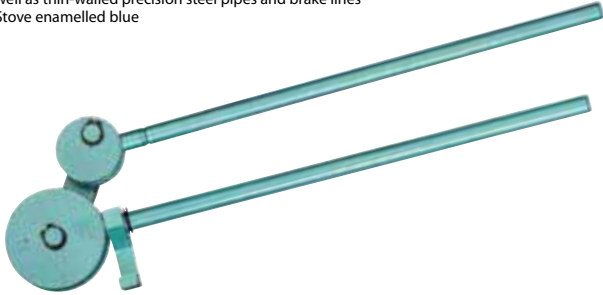

Code	No.	Ø mm	r = mm	l-mm-H	l-mm	l-mm
4564460	241005	4,75-5,0	18	255	525	1
4564540	241006	6,0	18	275	520	1
4564620	241008	8,0	28	340	780	1
4564700	241010	10,0	28	400	1110	1
4634690	241012	12,0	35	400	1800	1

2420

PIPE BENDING PLIERS with bending rail

- ✔ Sizes from 10 to 22 mm Ø, bends up to 90°
- ✔ With small radii
- ✔ For soft copper pipes EN 1057 and soft steel pipes (also with fixed coating)
- ✔ Blue powder-coated, handles PVC coated



Code	No.	Ø mm	r = mm	l-mm-H	l-mm	l-mm
1461516	242010	10	30	420	1.4	1
1461524	242012	12	30	420	1.4	1
1461532	242014	14	45	560	2.1	1
1409417	242015	15	45	560	2.2	1
1461540	242016	16	60	560	2.2	1
1409433	242018	18	74	820	3.0	1
1461567	242020	20	75	820	4.3	1
1461575	242022	22	75	820	4.3	1

2423

PIPE BENDING PLIERS with roller

- ✔ Sizes from 10 to 22 mm Ø, bends up to 90°
- ✔ For bendable steel and stainless steel pipes (max. wall thickness 1.5 mm) as well as soft, heat-insulated copper pipes EN 1057
- ✔ Enamelled blue



Code	No.	Ø mm	r = mm	l-mm-H	l-mm	l-mm
4564890	242310	10	43	420	1.4	1
4564970	242312	12	43	420	1.4	1
4565000	242315	15	60	560	2.1	1
4565190	242318	18	74	820	2.9	1
4538030	242320	20	86	820	3.6	1
4565270	242322	22	86	820	4.2	1

2424

PIPE BENDING PLIERS with bending rail

- ✔ Sizes from 10 to 22 mm Ø, bends up to 90°
- ✔ For thin-walled, bendable steel pipes (max. wall thickness 1.5 mm) as well as soft copper pipes EN 1057 (also with fixed coating)
- ✔ Slide rail powder-coated, enamelled blue



Code	No.	Ø mm	r = mm	l-mm-H	l-mm	l-mm
4565350	242410	10	43	420	1.4	1
4626670	242412	12	43	420	1.4	1
4565430	242415	15	60	560	2.1	1
4565510	242418	18	74	820	2.9	1
4565780	242420	20	86	820	3.6	1
4565860	242422	22	86	820	4.3	1

2425

PIPE BENDING PLIERS HH with plastic slide rail

- ✔ Sizes from 12 to 22 mm Ø, up to 90°
- ✔ Especially for semi-hard and soft copper pipes EN 1057
- ✔ Enamelled blue, with plastic slide rail



Code	No.	Ø mm	r = mm	l-mm-H	l-mm	l-mm
1224689	242512	12	43	420	1.4	1
1224670	242515	15	60	560	2.0	1
1224050	242518	18	74	820	2.8	1
1223690	242522	22	86	820	4.1	1





MANUAL PIPE BENDER – DRAW BENDING OPERATION

243

MANUAL BENDING TOOL SET

- ✔ In different sizes up to 90° or 180°
- ✔ For soft copper pipes EN 1057 (also with fixed coating), thin-walled precision steel pipes as well as pipes in non-ferrous metals
- ✔ Single-hand use of the benders with hand lever no. 243020 / 243030 or clamped to a vice with stationary bending former holder no. 243040
- ✔ Stove enamelled blue
- ✔ Delivery in sheet steel case no. 243090
- ✔ Special sets may be assembled to order



Code	No.	📏
4568450	243100 1 bending lever No. 243010 1 hand lever 90° No. 243020 1 hand lever 180° No. 243030 1 bending former holder, stationary No. 243040 5 bending formers 8, 10, 12, 14, 15 mm 1 pipe cutter 4-32 mm Ø No. 230010 1 sheet steel case No. 243090	9.4
4538380	243200 1 bending lever No. 243010 1 hand lever 90° No. 243020 4 bending formers for pipes with Ø 8, 10, 12, 15 mm 1 sheet steel case No. 243090	6.6
4568530	243600 1 bending lever No. 243010 1 hand lever 90° No. 243020 1 hand lever 180° No. 243030 1 bending former holder, stationary No. 243040 5 bending formers 5/16, 3/8, 7/16, 1/2, 5/8" 1 pipe cutter 4-32 mm Ø No. 230010 1 sheet steel case No. 243090	9.4
4568610	243700 1 bending lever No. 243010 1 hand lever 90° No. 243020 4 bending formers for pipes with Ø 5/16, 3/8, 1/2, 5/8" 1 sheet steel case No. 243090	6.7



E 243

PARTS

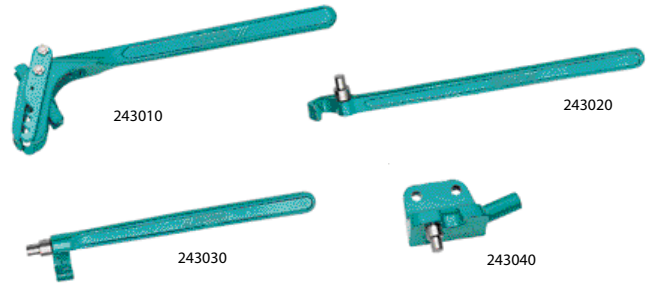

Code	No.	📏	📦
4566320	243010 Bending lever	980	1
4566400	243020 Hand lever 90 degrees	920	1
4566590	243030 Hand lever 180 degrees	920	1
4566670	243040 Bending former holder, stationary	950	1
4504050	230010 Pipe cutter QUICK AUTOMATIC 4-32 mm	435	1
4568370	243090 Sheet steel case	3460	1

E 243

BENDING FORMER



Code	No.	Ø inch	Ø mm	r = mm	📏	📦
4566750	243050		6,0	28	225	1
4566830	243051		8,0	28	200	1
4567050	243053		10,0	35	320	1
4567210	243055		12,0	35	300	1
4567560	243057		14,0	45	460	1
4567640	243058		15,0	45	420	1
4567720	243059		16,0	45	405	1
4567800	243065	5/16	7,94	28	220	1
4567990	243066	3/8	9,53	35	340	1
4568020	243067	7/16	11,11	35	315	1
4568100	243068	1/2	12,7	45	495	1
4568290	243069	5/8	15,88	45	410	1

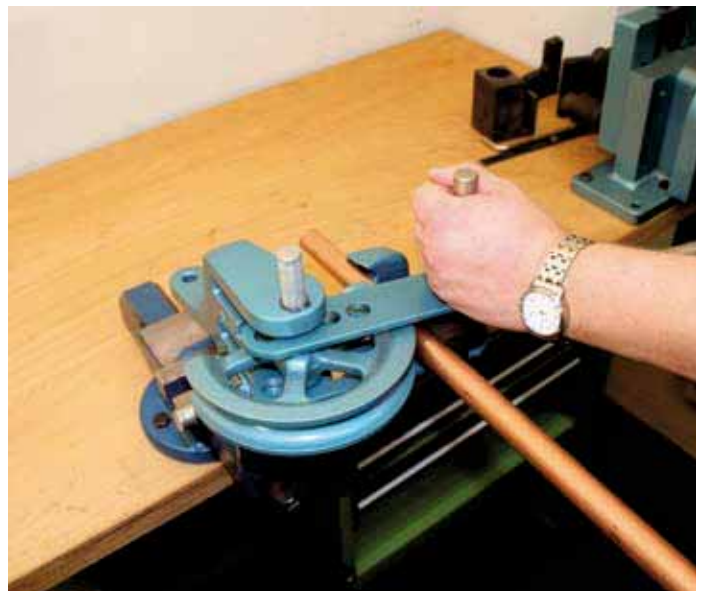

www.gedore.com



244

MANUAL BENDING TOOL SET

- ✔ In different sizes up to 180°
- ✔ For soft copper pipes EN 1057, hydraulic and precision steel pipes as well as pipes in non-ferrous metals
- ✔ For use in a vice
- ✔ Power-saving lever mechanism for easy operation
- ✔ Stove enamelled blue
- ✔ Delivery in sheet steel case no. 244090
- ✔ Special sets may be assembled to order



Code	No.	
4571750	244100 1 basic unit No. 244070 1 bending lever No. 244080 6 bending formers for pipes with Ø 15, 16, 18, 20, 22, 28 mm 1 pipe cutter 4-32 mm Ø No. 230010 1 sheet steel case No. 244090	25.4
4571830	244200 1 basic unit No. 244070 1 bending lever No. 244080 4 bending tools for pipes with Ø 15, 18, 22, 28 mm 1 sheet steel case No. 244090	22.4
4573450	244600 1 basic unit No. 244070 1 bending lever No. 244080 4 bending tools for pipes with Ø 5/8, 3/4, 7/8, 1" 1 pipe cutter 4-32 mm Ø No. 230010 1 sheet steel case No. 244090	22.8
4568880	244010 1 basic unit No. 244070 1 bending lever No. 244080 1 sheet steel case No. 244090 without bending tools	14.3



E 244

PARTS

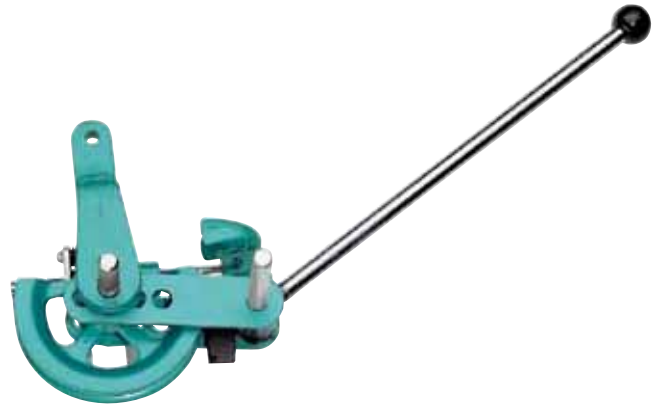

Code	No.		
4569930	244070 Basic unit	4.9	1
4571590	244080 Bending lever	2.4	1
4504050	230010 Pipe cutter QUICK AUTOMATIC 4-32 mm	0.4	1
4571670	244090 Sheet steel case	7.0	1

E 244

BENDING TOOLS

- ✔ Consisting of bending former and bending rail



Code	No.		\varnothing mm	r = mm		
4571910	244210		10,00	40	0.9	1
4572050	244212		12,00	40	0.9	1
4572210	244214		14,00	50	1.2	1
4572480	244215		15,00	50	1.1	1
4572560	244216		16,00	50	1.1	1
4572720	244218		18,00	65	1.5	1
4572800	244220		20,00	65	1.4	1
4572990	244222		22,00	85	2.3	1
4573100	244225		25,00	100	3.5	1
4573290	244228		28,00	100	3.2	1
4573370	244230		30,00	100	3.1	1
4568960	244035	5/8	15,88	50	1.1	1
4569180	244036	3/4	19,05	65	1.5	1
4569260	244037	7/8	22,22	85	2.1	1
4569340	244038	1	25,40	100	3.4	1

921



487

923



487



2780 - 2785

MANUAL BENDING TOOL SET

- ✔ Sizes from 3 to 10 mm up to 180°
- ✔ No. 2780 with steel bending formers for precision steel pipes EN 10305-3 (DIN 2394), hydraulic pipes EN 10305-1 (DIN 2391)
- ✔ No. 2785 with aluminium bending forms also for bendable stainless steel pipes with 1.0 - 1.2 mm wall thicknesses
- ✔ For clamping in a vice or useable as bending pliers
- ✔ Enamelled blue, with black plastic handles



278001



278501



Code	No.	
4539780	278000	1.5
		1 basic tool body No. 278070, 1 bending lever No. 278080, 4 steel bending formers for pipes with Ø 3-4, 5-6, 7-8, 10 mm
1543199	278001	2.7
		1 basic tool body No. 278070, 1 bending lever No. 278080, 4 steel bending formers for pipes with Ø 3-4, 5-6, 7-8, 10 mm 1 miniature pipe cutter 4-16 mm No. 231000, 1 pipe deburring reamer 4-32 mm No. 232001, 1 sheet steel case No. 278090
1589830	278500	1.2
		1 basic tool body No. 278570, 1 bending lever No. 278581, 4 aluminium bending formers for pipes with Ø 3-4, 5-6, 7-8, 10 mm
1589849	278501	2.4
		1 basic tool body No. 278570, 1 bending lever No. 278581, 4 aluminium bending formers for pipes with Ø 3-4, 5-6, 7-8, 10 mm 1 miniature pipe cutter 4-16 mm No. 231000, 1 pipe deburring reamer 4-32 mm No. 232001, 1 sheet steel case No. 278090

E 2780 - E 2785

PARTS



278080



278070

E 2780 - E 2785

BENDING FORMER

- ✔ No. 278004-278010 steel type
- ✔ No. 278504-278510 aluminium type



Code	No.	Length	Weight
4603110	278070	640	1
		Basic tool body size 0	
2293625	278570	640	1
		Basic tool body size 0 for VA	
4603380	278080	380	1
		Bending lever size 0	
2293641	278581	380	1
		Bending lever size 0 for VA	
1526189	278090	1040	1
		Sheet steel case for 278001+501	

Code	No.	Ø mm	r = mm	Weight	Length
4602650	278004	3-4	14	49	1
4602730	278006	5-6	16	63	1
4602810	278008	7-8	24	156	1
4603030	278010	10	29	220	1
1576798	278504	3-4	14	20	1
1576801	278506	5-6	16	25	1
1576828	278508	7-8	24	55	1
1576836	278510	10	29	85	1



2781 - 2786

MANUAL BENDING TOOL SET

- Sizes from 6 to 18 mm up to 180°
- No. 2781 with steel bending formers for precision steel pipes EN 10305-3 (DIN 2394), hydraulic pipes EN 10305-1 (DIN 2391)
- No. 2786 with aluminium bending forms also for bendable stainless steel pipes with 1.2 - 1.5 mm wall thicknesses
- For clamping in a vice
- Enamelled blue, with black plastic handles, type 278601 with pluggable aluminium bending lever



278601

Code	No.	
4603460	278100	1 basic tool body No. 278170, 1 bending lever No. 278180, 6 steel bending formers for pipes with Ø 6-8, 10-12, 14, 15, 16, 18 mm
1589857	278600	1 basic tool body No. 278670, 1 bending lever No. 278681, 6 aluminium bending formers for pipes with Ø 6-8, 10-12, 14, 15, 16, 18 mm
1611526	278601	1 basic tool body No. 278670, 1 bending lever pluggable No. 278680, 6 aluminium bending formers for pipes with Ø 1 pipe cutter 4-35 mm, 1 pin punch 3 mm, 1 sheet steel case No. 278190

E 2781 - E 2786

PARTS



Code	No.		
4604000	278170	1240	1
	Basic tool body size 1		
1677209	278670	1240	1
	Basic tool body size 1 for VA		
4604190	278180	2300	1
	Bending lever size 1		
2293692	278681	2300	1
	Bending lever size 1 for VA		
1626043	278680	1930	1
	Bending lever size 1 pluggable for VA		
1611534	278190	4180	1
	Sheet steel case for 278601		

E 2781 - E 2786

BENDING FORMER

- No. 278108-278118 steel type
- No. 278608-278618 aluminium type



Code	No.	Ø mm	r = mm		
4603540	278108	6-8	32	560	1
4603620	278112	10-12	36	600	1
4603700	278114	14	36	560	1
4624890	278115	15	43	880	1
4603890	278116	16	43	850	1
4603970	278118	18	50	1180	1
1576844	278608	6-8	32	200	1
1576852	278612	10-12	36	220	1
1576879	278614	14	36	200	1
1576887	278615	15	43	320	1
1576895	278616	16	43	320	1
1576909	278618	18	50	450	1



2782 - 2787

MANUAL BENDING TOOL SET

- ✔ Sizes from 20 to 25 mm up to 180°
- ✔ No. 2782 with steel bending formers for precision steel pipes EN 10305-3 (DIN 2394), hydraulic pipes EN 10305-1 (DIN 2391)
- ✔ No. 2787 with aluminium bending forms also for bendable stainless steel pipes with 1.5 - 2.0 mm wall thicknesses
- ✔ For clamping in a vice
- ✔ Enamelled blue, with black plastic handles

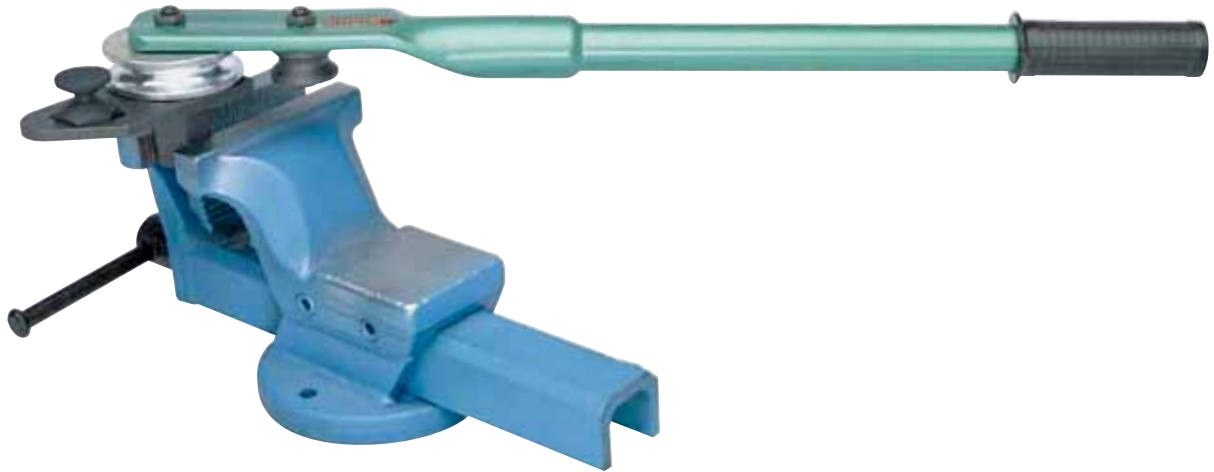

Code	No.	Weight
4539860	278200 1 basic tool body No. 278270, 1 bending lever No. 278280, 3 steel bending formers for pipes with Ø 20, 22, 25 mm	22.6
1589865	278700 1 basic tool body No. 278770, 1 bending lever No. 278781, 3 aluminium bending formers for pipes with Ø 20, 22, 25 mm	13.0

E 2782 - E 2787

PARTS



Code	No.	Weight	Quantity
4604510	278270 Basic tool body size 2	4140	1
2293706	278770 Basic tool body size 2 for VA	4140	1
4604780	278280 Bending lever size 2	3000	1
2293722	278781 Bending lever size 2 for VA	3000	1

E 2782 - E 2787

BENDING FORMER

- ✔ No. 278220-278225: steel type
- ✔ No. 278720-278725: aluminium type



Code	No.	Ø mm	r = mm	Weight	Quantity
4604270	278220	20	85	5380	1
4604350	278222	22	85	5180	1
4604430	278225	25	85	4900	1
1576917	278720	20	85	2000	1
1576925	278722	22	85	1950	1
1576933	278725	25	85	1950	1





922





487



923





487



240

PIPE BENDER SET with slide rail / with roller

- ✔ Sizes from 12 to 22 mm Ø up to 180°
- ✔ No. 2400: With slide rail for semi-hard and soft copper pipes EN 1057, soft steel pipes (also with fixed coating) as well as aluminium and brass pipes
- ✔ No. 2405: With rollers for semi-hard and soft copper pipes EN 1057, hydraulic pipes EN 10305-1 (DIN 2391), precision steel pipes EN 10305-3 (DIN 2394) as well as soft steel, aluminium and brass pipes
- ✔ For use in a vice
- ✔ Delivery in assembly case no. 240090



Code	No.		16.7
4537730	240001	4 pipe bending tools with slide rail for pipe-Ø 12, 15, 18, 22 mm 1 pipe cutter 4-35 mm 1 pipe deburring reamer 4-35 mm No. 232001 1 assembly case No. 240090	17.9
4632800	240501	4 pipe bending tools with roller for pipe-Ø 12, 15, 18, 22 mm 1 pipe cutter 4-35 mm 1 pipe deburring reamer 4-35 mm No. 232001 1 assembly case No. 240090	17.9
4562250	240090	Assembly case, empty	4.6

240

PIPE BENDER with slide rail / with roller

- ✔ Sizes from 10 to 22 mm Ø up to 180°
- ✔ No. 2400: With slide rail for semi-hard and soft copper pipes EN 1057, soft steel pipes (also with fixed coating) as well as aluminium and brass pipes
- ✔ No. 2405: With rollers for semi-hard and soft copper pipes EN 1057, hydraulic pipes EN 10305-1 (DIN 2391), precision steel pipes EN 10305-3 (DIN 2394) as well as soft steel, aluminium and brass pipes
- ✔ For use in a vice



Code	No.	Ø mm	r = mm	16.7	1
2001284	240010	10	45	1.7	1
4561790	240012	12	45	1.7	1
4561950	240015	15	65	2.1	1
4562170	240018	18	80	3.5	1
4537810	240022	22	80	4.4	1
2001292	240510	10	45	1.7	1
4633020	240512	12	45	1.7	1
4633290	240515	15	65	2.1	1
4633450	240518	18	80	3.5	1
4633610	240522	22	80	4.4	1

276

UNIVERSAL PIPE BENDER

- ✔ Sizes from 6 to 32 mm Ø and 1/8 to 3/4" up to 180°
- ✔ For semi-hard and soft copper pipes EN 1057 up to 22 mm Ø, stainless steel pipes EN 10088-3 (DIN 17 440) up to 28 x 1.5 mm, hydraulic pipes EN 10305-1 (DIN 2391) and precision steel pipes EN 10305-3 (DIN 2394) up to 28 mm, electrical installation pipes EN 60423 up to M 32, composite pipes up to 32 mm, non-ferrous metal pipes and insulated pipes as well as gas and water pipes EN 10255 (DIN 2440/2441) up to 3/4"
- ✔ For use in a vice or installation on the workbench
- ✔ Set up for connecting to a length and angle stop as well as bending lever extension possible (not included)
- ✔ Enamelled blue



Code	No.		16.7	
4600010	276000	Basic equipment with bending lever extension no. 268230, without bending tools	16.7	
4600280	276001	Angled stop	1.8	
4606210	280130	Length stop	0.7	51.48

E 276

BENDING TOOLS

- ✔ No. 276506-276920: Bending former with aluminium slide rail for metric pipes
- ✔ No. 276101-276107: Bending former for gas and water pipes EN 10255 (DIN 2440/2441), use with pressure roller no. 276003 (1/8-3/4")



Code	No.	Size	Ø mm	r = mm	Electrical installation ducts EN 60423	16.7	1
4600950	276506		6,0	40		1.5	1
4601090	276508		8,0	40		1.4	1
4601170	276510		10,0	40		1.4	1
4601250	276512		12,0	40		1.4	1
1553682	276912		12,0	81	M12	6.5	1
4601330	276514		14,0	50		1.9	1
4601410	276515		15,0	50		1.8	1
4601680	276516		16,0	68		4.7	1
1553690	276916		16,0	81	M16	6.5	1
4601760	276518		18,0	68		4.7	1
4601840	276519		19,0	68		4.6	1
4601920	276520		20,0	68		4.6	1
1553704	276920		20,0	105	M20	4.8	1
4602060	276522		22,0	81		6.5	1
4602140	276525		25,0	105	M25	4.7	1
4602300	276528		28,0	126		5.4	1
4602490	276530		30,0	153		7.0	1
4602570	276532		32,0	153	M32	7.0	1
4600440	276101	1/8	10,2	40		1.2	1
4600520	276102	1/4	13,5	40		1.2	1
4600600	276103	3/8	17,2	50		1.6	1
4600790	276105	1/2	21,3	68		2.4	1
4600870	276107	3/4	26,9	80		5.8	1
4600360	276003	1/8-3/4				0.5	1





MANUAL PIPE BENDER – PUSHING BENDING OPERATION

2455

PIPE BENDER SET MANUAL

- ✔ Sizes from 10 to 22 mm Ø up to 90°
- ✔ For soft copper pipes EN 1057 (also heat-insulated)
- ✔ Mechanical ratchet feed
- ✔ Deliver in plastic case no. 245590



Code	No.	
4634850	245510 1 basic unit, mechanical no. 245570 7 bending tools for pipes with Ø 10, 12, 14, 15, 18, 20, 22 mm 1 plastic case no. 245590	5.0

2454

PIPE BENDER SET FOR COMPOSITE PIPES hydraulic

- ✔ Sizes from 16 to 32 mm Ø up to 90°
- ✔ For multi-layer composite pipes
- ✔ Hydraulic drive without great effort
- ✔ Delivery in plastic case no. 245490



Code	No.	
1443550	245410 1 basic unit, hydraulic no. 245670 4 bending tools for pipes with Ø 16, 20, 26, 32 mm 1 plastic case no. 245490	7.3

2456

PIPE BENDER SET hydraulic

- ✔ Sizes from 10 to 22 mm Ø up to 90°
- ✔ For soft copper pipes EN 1057 up to 22 mm (also heat-insulated) as well as precision steel pipes EN 10305-3 (DIN 2394) up to 18 x 1.5 mm
- ✔ Hydraulic drive without great effort
- ✔ Delivery in plastic case no. 245590



Code	No.	
4635230	245610 1 basic unit, hydraulic no. 245670 7 bending tools for pipes with Ø 10, 12, 14, 15, 18, 20, 22 mm 1 plastic case no. 245590	6.2

2456

PIPE BENDER SET hydraulic, heavy-duty

- ✔ From 6 to 22 mm Ø, bends up to 90°
- ✔ For soft copper pipes EN 1057 up to 22 mm (also heat-insulated), precision steel pipes EN 10305-3 (DIN 2394) up to 18 x 2 mm, as well as annealed stainless steel pipes up to 18 x 1.2 mm
- ✔ Hydraulic drive without great effort
- ✔ In plastic case no. 245690



Code	No.	
1585495	245611 1 basic unit, hydraulic no. 245670 10 bending tools for pipes with Ø 6, 8, 10, 12, 14, 15, 16, 18, 20, 22 mm 1 plastic case no. 245690	7.5



E 2454 - E 2456

PARTS

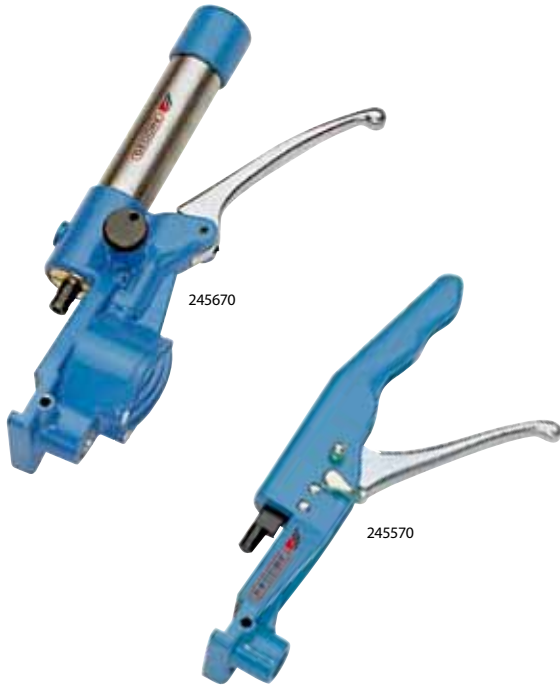

Code	No.	⌀ mm	⊠
4634930	245570 Basic unit, mechanical	1150	1
4635310	245670 Basic unit, hydraulic	2350	1
1443437	245490 Plastic case empty for no. 245410	1700	1
4635070	245590 Plastic case empty for no. 245510 + 245610	1700	1
1585568	245690 Plastic case empty for no. 245611	1700	1



E 2454 - E 2456

BENDING TOOLS

- ▣ The bending former and counter-support are needed in each instance
- ▣ Bending former no. 245805-245824 and counter-support no. 245710-245731 for metric pipes
- ▣ Bending former no. 245916-245932 and counter-support no. 245740-245770 for composite pipes



Code	No.	⌀ mm	r = mm	⌀ mm	⊠
4635820	245805	5	31	100	1
4635900	245806	6	31	100	1
4636040	245808	8	31	100	1
4636120	245810	10	31	100	1
4636200	245812	12	34	110	1
4636390	245814	14	41	120	1
4636470	245815	15	48	140	1
4636550	245816	16	49	150	1
4636630	245817	17	51	140	1
4636710	245818	18	72	190	1
4636980	245820	20	80	200	1
4637010	245822	22	88	200	1
4637280	245824	24	90	200	1
1443399	245916	16	49	140	1
1443402	245920	20	80	180	1
1443410	245926	26	93	240	1
1443429	245932	32	119	480	1
4635580	245710 Counter-support	5-12		380	1
4635660	245720 Counter-support	14-17		460	1
1585509	245721 Counter-support reinforced	14-17		380	1
4635740	245730 Counter-support	18-24		460	1
1585517	245731 Counter-support reinforced	18-24		480	1
1443356	245740 Counter-support composite pipes	16		340	1
1443364	245750 Counter-support composite pipes	20		440	1
1443372	245760 Counter-support composite pipes	26		480	1
1443380	245770 Counter-support composite pipes	32		840	1



923



487



921



487

PIPE BENDING MACHINES – DRAW BENDING OPERATION

246

PIPE BENDING MACHINE manual-hydraulic

- ✔ Sizes from 12 to 28 mm Ø up to 180°
- ✔ For semi-hard and soft copper pipes EN 1057 up to 28 mm Ø, stainless steel pipes EN 10088-3 (DIN 17 440) up to 22 x 1.5 mm, hydraulic pipes EN 10305-1 (DIN 2391) and precision steel pipes EN 10305-3 (DIN 2394) up to 22 x 2 mm, composite pipes up to 20 mm as well as gas and water pipes EN 10255-M (DIN 2440) up to 3/4"
- ✔ Pressure 60 kN
- ✔ On pivotable tripod
- ✔ Delivery in wooden assembly case





Code	No.	
4538890	246100 1 basic tool No. 246070 1 pump, manual-hydraulic, No. 246080 1 pivotable tripod No. 268000 5 bending tools for pipes with Ø 12, 15, 18, 22, 28 mm	57.0

Code	No.	
4574260	246010 1 basic tool No. 246070 1 pump, manual-hydraulic, No. 246080 1 pivotable tripod No. 268000 without bending tools	49.0

E 246

PARTS

Code	No.		
4574340	246070 Basic tool without hydraulic pump	15.5	1
4574420	246080 Pump, manual-hydraulic	16.2	1
4599760	268000 Pivotable tripod	6.2	1





E 246

BENDING TOOLS

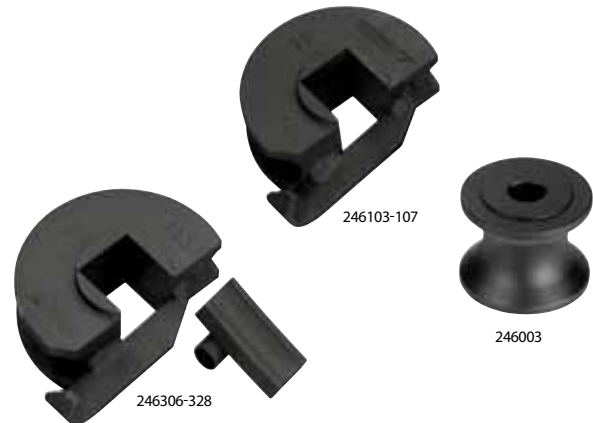
- ✔ No. 246306-246328: Bending form with slide rail for metric pipes
- ✔ No. 246103-246107: Bending form for gas and water pipes EN 10255-M (DIN 2440), use with pressure roller no. 246003 (3/8"-3/4")



Code	No.	Size	Ø mm	r = mm		
4637870	246306		6,0	35	0.6	1
4637950	246308		8,0	35	0.5	1
4638090	246310		10,0	45	0.5	1
4575070	246312		12,0	45	0.5	1
4575150	246314		14,0	55	0.9	1
4575230	246315		15,0	55	0.9	1
4575310	246316		16,0	75	1.1	1
4575660	246318		18,0	75	1.4	1
4575740	246320		20,0	75	1.8	1
4575820	246322		22,0	85	2.0	1
4575900	246325		25,0	85	3.1	1
4576040	246328		28,0	112	4.0	1
4637440	246103	3/8	17,2	55	1.2	1
4637520	246105	1/2	21,3	65	1.7	1
4637600	246107	3/4	26,9	85	3.6	1
4637360	246003	3/8-3/4			0.3	1

 **250**



GEDORE also manufactures pipe benders for thin-walled pipes up to 2" - please enquire!



249

PIPE BENDING MACHINE manual-hydraulic

- ✔ Sizes from 12 to 54 mm Ø up to 90°
- ✔ For copper pipes EN 1057, precision steel pipes EN 10305-3 (DIN 2394) and hydraulic pipes EN 10305-1 (DIN 2391), stainless steel pipes EN 10088-3 (DIN 17 440) up to 42 mm, uncoated pipes and pipes with fixed coating, composite pipes as well as electrical installation pipes EN 60423
- ✔ Pressure 100 kN
- ✔ On pivotable tripod
- ✔ Delivery in wooden assembly case



Code	No.	
4580150	249000	76.0
1 pump manual-hydraulic No. 254200 1 base unit with pivotable tripod No. 249310 without bending tools		

249

PIPE BENDING MACHINE electro-hydraulic

- ✔ Sizes from 12 to 54 mm Ø up to 90°
- ✔ For copper pipes EN 1057, precision steel pipes EN 10305-3 (DIN 2394) and hydraulic pipes EN 10305-1 (DIN 2391), stainless steel pipes EN 10088-3 (DIN 17 440) up to 42 mm, uncoated pipes and pipes with fixed coating, composite pipes as well as electrical installation pipes EN 60423
- ✔ Electrical limiter for continuous pre-setting and repetition in the production of pipe bends
- ✔ Pressure 100 kN
- ✔ On pivotable tripod
- ✔ Delivery in wooden assembly case

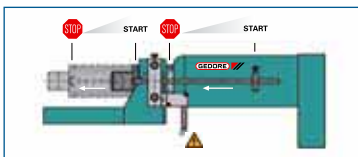

Code	No.	
4580230	249001	111.0
1 pump electro-hydraulic 380-415 V No. 254601 1 base unit with pivotable tripod No. 249311 without bending tools		
1547593	249002	111.0
1 pump electro-hydraulic 230 V No. 254651 1 base unit with pivotable tripod No. 249311 without bending tools		

E 249

PARTS

- ✔ Pumps exchangeable for benders no. 257, 258 and 280

Code	No.		
4582280	249310	42.5	1
Base unit with tripod for manual-hydraulic bending tool			
4640310	249311	53.7	1
Base unit with tripod for electro-hydraulic bending tool			
4584810	254200	21.5	1
Pump 2" manual-hydraulic			
1599984	254601	41.0	1
Pump 2" 380-415 V with electrical limiter			
1599992	254651	40.8	1
Pump 2" 230 V with electrical limiter			

E 249

BENDING TOOLS

- ✔ Consisting of bending former, pipe holder and aluminium slide rail
- ✔ For shaping stainless steel pipes, bending formers, pipe holders and steel bending rails - chemically nickel-plated - are available on request
- ✔ Special sizes available on request



Code	No.	Size	Ø mm	Electrical installation ducts EN 60423	Precision steel pipes EN 10305-3	Cu pipes EN 1057	r = mm		
1527339	249812	12,0		M 12	12	12	85	2.9	1
4640660	249815	15,0			15	15	85	2.9	1
4654290	249816	16,0		M16	16	16	85	2.9	1
4654370	249818	18,0			18	18	85	2.9	1
4654530	249820	20,0			20	20	85	2.9	1
1546090	249020	20,0		M20			100	3.9	1
4654610	249822	22,0			22	22	85	2.9	1
4582520	249825	25,0			25		85	3.5	1
1546120	249025	25,0		M25			100	3.9	1
4582600	249828	28,0			28		85	3.5	1
4580310	249028	28,0				28	100	3.5	1
4582790	249830	30,0			30		85	3.4	1
4580580	249030	30,0					100	3.7	1
4580660	249032	32,0			32		100	6.5	1
1546147	249132	32,0		M32			150	7.5	1
4580820	249035	35,0			35		100	6.0	1
4580900	249135	35,0				35	150	7.3	1
4581120	249138	38,0			38		150	7.1	1
4581200	249140	40,0			40		150	7.7	1
1546163	249240	40,0		M40			200	12.9	1
4581470	249142	42,0			42		150	7.7	1
1561944	249242	42,0					200	13.4	1
4581550	249145	45,0			45		150	7.5	1
4581710	249250	50,0		M50	50		200	13.1	1
4582010	249254	54,0					200	12.4	1
1742655	249503	3/8	17,2				85	4.0	1
1639935	249505	1/2	21,3				100	4.0	1
1422820	249507	3/4	26,9				100	6.5	1
1276190	249510	1	33,7				150	7.5	1
1549561	249512	1.1/4	42,4				150	7.5	1
1232401	249515	1.1/2	48,3				200	14.5	1
2125242	249605		12,7				100	3.9	1
2125250	249606		15,88				100	3.9	1
2125269	249607		19,05				100	3.9	1
2125277	249608		22,22				150	7.5	1
2125293	249610		25,4				200	12.9	1
2125315	249612		31,75				200	12.9	1



PIPE BENDING MACHINES – PUSHING BENDING OPERATION

max. bending capacities Pipe bending machines 255-260

Bender no.	Gas and water pipes EN 10205 (DIN 2440/2441)		Distilling pipes EN 10220 (DIN 2448)		Electrical installation pipes EN 60423	Railing tubes *)	Metric tubes *)		Multi-layer composite pipes
	up to 90°	up to 180°	up to 90°		up to 90°	up to 90°	up to 90°	up to 180°	up to 90°
	Size	Size	Size	Ø mm	Nominal size	Size	Ø mm	Ø mm	Ø mm
255 - 256	3/8 - 1.1/4"	–	3/8 - 1"	25 - 32	M12 - M20	3/8 - 3/4"	14 - 35	–	–
257 - 258	3/8 - 2"	3/4 - 1.1/2"	3/8 - 1.1/2"	25 - 51	M12 - M40	3/8 - 1.1/4"	14 - 51	25 - 50	40 - 63 (No. 258)
259 - 260	3/8 - 3"	–	3/8 - 2.1/2"	25 - 70	M12 - M50	3/8 - 2"	14 - 70	–	–

*) Specifications under reserve - as these are dependent on the respective wall thickness

255 - 256

PIPE BENDING MACHINE 3/8" - 1.1/4"

For gas and water pipes EN 10205 (DIN 2440/2441) up to max. 90°

Available in various designs:

- manually or electro-hydraulically operated
- with open or fold-open bending frame
- as the basic tool without bending former or as a set with bending former no. 263103-112
- Pressure 60 kN
- Delivery in assembly case

Optional bending tools under no. 263 - 265 available for:

- Distilling pipes EN 10220 (DIN 2448) from 3/8 to 1" or 25 to 32 mm
- Railing tubes from 3/8 to 3/4"
- Electrical installation pipes EN 60423 from M12 to M20
- Metric pipes from 14 to 35 mm
- Bending tools for stainless steel pipes on request



257 - 258

PIPE BENDING MACHINE 3/8" - 2"

For gas and water pipes EN 10205 (DIN 2440/2441) up to max. 90°

With bending tools as an option which can be used up to a max. 180°

Available in various designs:

- manually or electro-hydraulically operated
- with open or fold-open bending frame
- as the basic tool without bending former or as a set with bending former no. 263103-120
- Pressure 100 kN
- Delivery in assembly case

Optional bending tools under no. 263 - 267 available for:

- Distilling pipes EN 10220 (DIN 2448) from 3/8 to 1.1/2" or 25 to 51 mm
- Railing tubes from 3/8 to 1.1/4"
- Electrical installation pipes EN 60423 from M12 to M40
- Metric pipes from 14 to 51 mm
- Multi-layer composite pipes from 40 to 63 mm (no. 258)
- Gas and water pipes EN 10205 (DIN 2440/2441) from 3/4 to 1.1/2" up to 180°
- Metric pipes from 25 to 50 mm up to 180°
- straightening steel pipes and scaffold tubes 1.1/2"
- Bending tools for stainless steel pipes on request



Code	No.	included in delivery	Ill.	mm
4586190	255000	manual-hydraulic, fold-open bending frame, without bending formers	A	39.0
4586270	255100	manual-hydraulic, fold-open bending frame, with 5 bending formers no. 263103-112	A	48.0
4586350	255500	electro-hydraulic 380-415 V, fold-open bending frame, without bending formers	B	65.0
4586430	255510	electro-hydraulic 380-415 V, fold-open bending frame, with 5 bending formers no. 263103-112	B	74.0
4586510	255600	electro-hydraulic 230 V, fold-open bending frame, without bending formers	B	65.0
4586780	255610	electro-hydraulic 230 V, fold-open bending frame, with 5 bending formers no. 263103-112	B	74.0
4586860	256000	manual-hydraulic, open bending frame, without bending formers	C	47.0
4586940	256100	manual-hydraulic, open bending frame, with 5 bending formers no. 263103-112	C	56.0
4587080	256500	electro-hydraulic 380-415 V, open bending frame, without bending formers	D	73.0
4587160	256510	electro-hydraulic 380-415 V, open bending frame, with 5 bending formers no. 263103-112	D	82.0
4587240	256600	electro-hydraulic 230 V, open bending frame, without bending formers	D	73.0
4587320	256610	electro-hydraulic 230 V, open bending frame, with 5 bending formers no. 263103-112	D	82.0

Code	No.	included in delivery	Ill.	mm
4587400	257000	manual-hydraulic, fold-open bending frame, without bending formers	A	54.0
4587590	257100	manual-hydraulic, fold-open bending frame, with 7 bending formers no. 263103-120	A	75.0
4587670	257500	electro-hydraulic 380-415 V, fold-open bending frame, without bending formers	B	78.0
4587750	257510	electro-hydraulic 380-415 V, fold-open bending frame, with 7 bending formers no. 263103-120	B	99.0
4587830	257600	electro-hydraulic 230 V, fold-open bending frame, without bending formers	B	78.0
4587910	257610	electro-hydraulic 230 V, fold-open bending frame, with 7 bending formers no. 263103-120	B	99.0
4588050	258000	manual-hydraulic, open bending frame, without bending formers	C	73.0
4588130	258100	manual-hydraulic, open bending frame, with 7 bending formers no. 263103-120	C	95.0
4588210	258500	electro-hydraulic 380-415 V, open bending frame, without bending formers	D	98.0
4588480	258510	electro-hydraulic 380-415 V, open bending frame, with 7 bending formers no. 263103-120	D	119.0
4588560	258600	electro-hydraulic 230 V, open bending frame, without bending formers	D	98.0
4588640	258610	electro-hydraulic 230 V, open bending frame, with 7 bending formers no. 263103-120	D	119.0



**259 - 260****PIPE BENDING MACHINE 3/8" - 3"**

For gas and water pipes EN 10205 (DIN 2440/2441) up to max. 90°

**Available in various designs:**

- manually or electro-hydraulically operated
- with open or fold-open bending frame
- as the basic tool without bending former or as a set with bending former no. 263103-130
- Pressure 160 kN
- Delivery in assembly case

Optional bending tools under no. 263 - 265 available for:

- Distilling pipes EN 10220 (DIN 2448) from 3/8 to 2.1/2" or 25 to 70 mm
- Railing tubes from 3/8 to 2"
- Electrical installation pipes EN 60423 from M12 to M50
- Metric pipes from 14 to 70 mm

Bending tools for stainless steel pipes on request



Code	No.	included in delivery	Ill.	mm
4588720	259000	manual-hydraulic, fold-open bending frame, without bending formers	A	98.0
4588800	259100	manual-hydraulic, fold-open bending frame, with 9 bending formers no. 263103-130	A	173.0
4588990	259500	electro-hydraulic 380-415 V, fold-open bending frame, without bending formers	B	123.0
4589020	259510	electro-hydraulic 380-415 V, fold-open bending frame, with 9 bending formers no. 263103-130	B	198.0
4589100	259600	electro-hydraulic 230 V, fold-open bending frame, without bending formers	B	123.0
4589290	259610	electro-hydraulic 230 V, fold-open bending frame, with 9 bending formers no. 263103-130	B	198.0
4589370	260000	manual-hydraulic, open bending frame, without bending formers	E	120.0
4589450	260100	manual-hydraulic, open bending frame, with 9 bending formers no. 263103-130	E	207.0
4589530	260500	electro-hydraulic 380-415 V, open bending frame, without bending formers	F	155.0
4589610	260510	electro-hydraulic 380-415 V, open bending frame, with 9 bending formers no. 263103-130	F	242.0
4589880	260600	electro-hydraulic 230 V, open bending frame, without bending formers	F	155.0
4589960	260610	electro-hydraulic 230 V, open bending frame, with 9 bending formers no. 263103-130	F	242.0

258**PIPE BENDING MACHINE MSR 40 - 63 MM**

For multi-layer composite pipes up to a max. 90°

**Available in various designs:**

- With open bending frame
- manually or electro-hydraulically operated
- as basic tool without bending former or as a set with bending former no. 263940-963 and no. 258940-963
- Pressure 100 kN
- Delivery in assembly case

**Optional bending tools under no. 263 - 267 available for:**

- Gas and water pipes EN 10205 (DIN 2440/2441) from 3/8 to 2"
- Distilling pipes EN 10220 (DIN 2448) from 3/8 to 1.1/2" or 25 to 51 mm
- Railing tubes from 3/8 to 1.1/4"
- Electrical installation pipes EN 60423 from M12 to M40
- Metric pipes from 14 to 51 mm
- Gas and water pipes EN 10205 (DIN 2440/2441) from 3/4 to 1.1/2" up to 180°
- Metric pipes from 25 to 50 mm up to 180°
- straightening steel pipes and scaffold tubes 1.1/2"

Bending tools for stainless steel pipes on request



Code	No.	included in delivery	mm
4588050	258000	manual-hydraulic, open bending frame, without bending formers	73.0
2302829	258102	manual-hydraulic, open bending frame, with bending formers no. 263940-963 and counter-supports no. 258940-963	79.0
4588210	258500	electro-hydraulic 380-415 V, open bending frame, without bending formers	98.0
2302837	258512	electro-hydraulic 380-415 V, open bending frame, with bending formers no. 263940-963 and counter-supports no. 258940-963	104.0
4588560	258600	electro-hydraulic 230 V, open bending frame, without bending formers	98.0
2302845	258612	electro-hydraulic 230 V, open bending frame, with bending formers no. 263940-963 and counter-supports no. 258940-963	104.0

i 261

GEDORE also manufactures pipe benders for pipes up to 4" - please enquire!

**➔ 268****559****➔ 254****559****➔ 2631-2671****560****-****561**



254

PUMP manual-hydraulic

- Available in various power stages
- For bending without great effort
- Option to re-fit with electrical drive no. 254950 (380-415 V) or no. 254955 (230 V)



Code	No.	Size	Use in machine No.	Weight
4584730	254100	1.1/4	255-256	16.2
4584810	254200	2	249, 257-258, 2804	21.5
4585030	254300	3	259-260	29.3

254

PUMP electro-hydraulic

- Available in various power stages
- No. 254601 and no. 254651 with electrical limiter for continuous pre-setting and repetition in the production of pipe bends

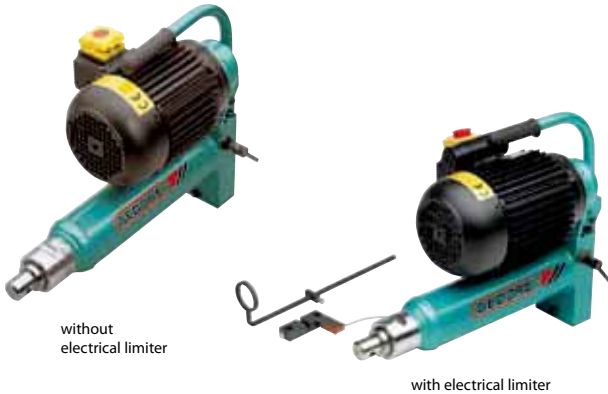

without electrical limiter

with electrical limiter

Code	No.	Size	Use in machine No.	Connection voltage Volt	Weight
4585380	254500	1.1/4	255-256	380-415	35.0
4585460	254550	1.1/4	255-256	230	35.0
4585540	254600	2	257-258	380-415	40.0
1599984	254601	2	249, 2804	380-415	41.0
4585620	254650	2	257-258	230	40.0
1599992	254651	2	249, 2804	230	40.8
4585700	254700	3	259-260	380-415	48.0
4585890	254750	3	259-260	230	48.0

269

HYDRAULIC OIL 1 litre

- For use with all GEDORE hydraulic pumps
- The volume stated is required each time



Code	No.	for pumps	required volume litre	Weight
4599920	269000	1.1/4"	0,90	880 1
		2"	1,25	
		3"	1,90	

E 254

GASKET SET

- For all GEDORE hydraulic pumps with machine number 254....
- For equipment with other than the stated machine no. available on request
- Contains the most-frequently required wear parts
- We also recommend that the hydraulic oil is changed each time, see no. 269



Code	No.	for	Weight	Quantity
4687890	254160	Machine no. 2541...	70	1
4689080	254260	Machine no. 2542...	75	1
4690170	254360	Machine no. 2543...	80	1
4690840	254560	Machine no. 2545...	70	1
4624620	254660	Machine no. 2546...	75	1
4691140	254760	Machine no. 2547...	80	1



When ordering spares, do indicate the pump number affixed at the pump housing

E 255 - E 260

BENDING FRAME

- Available in the open or fold-open design
- Without add-on components



fold-open

open

Code	No.	Size	Use in machine No.	Execution	Weight
4641200	255010	1.1/4	255	fold-open	7.7
4641550	256010	1.1/4	256	open	15.4
4642010	257010	2	257	fold-open	12.4
4642440	258010	2	258	open	31.2
4642870	259010	3	259	fold-open	37.2
4643170	260010	3	260	open	95.0

E 255 - E 260

COUNTER-SUPPORT (PIECE)

- Please note: 2 pieces of them are needed

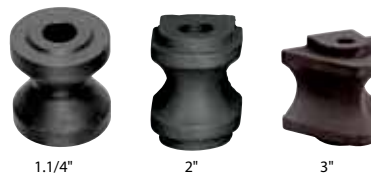

1.1/4"

2"

3"

Code	No.	Size	Use in machine No.	Weight	Quantity
4641390	255015	1.1/4	255	1.6	1
4641630	256015	1.1/4	256	1.4	1
4642280	257015	2	257	3.2	1
4642520	258015	2	258	2.9	1
4642950	259015	3	259	5.3	1
4643250	260015	3	260	4.3	1



E 255 - E 260

COUNTER-SUPPORT FIXING PIN (PIECE)

► Please note: 2 pieces of them are needed



Code	No.	Size	Use in machine No.		
4641470	255020	1.1/4	255	300	1
4641710	256020	1.1/4	256	850	1
4642360	257020	2	257	440	1
4642600	258020	2	258	960	1
4643090	259020	3	259	480	1
4643330	260020	3	260	2020	1

E 255 - E 260

U-YOKE



Code	No.	Size	Use in machine No.		
4721660	256030	1.1/4	255-256	180	1
4641980	258030	2	249, 257-258, 2804	400	1
4643410	260030	3	259-260	480	1

254

ELECTRICAL CONVERSION KIT

- Complete retrofitting set for hand hydraulic pumps consisting of electric motor (380-415 V or 230 V), cam drive, conveying unit, carrying handle and all incidental parts needed
- For all hand-operated GEDORE hydraulic pumps 1.1/4", 2" and 3" from 2001, for older pumps on request



► * Can only be used in connection with electrical limiter no. 254680



Code	No.	Use in machine No.	Connection voltage Volt	
4718870	254950	249*, 255-260, 2804*	380-415	19.0
4718950	254955	249*, 255-260, 2804*	230	19.0

254

ELECTRICAL LIMITER

- For continuous pre-setting and repetition in the production of pipe bends
- Electrically-powered pipe and angle bending tools no. 249 and 2804 can be upgraded
- Enamelled black

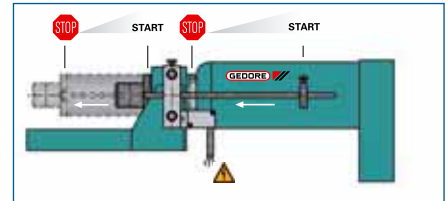
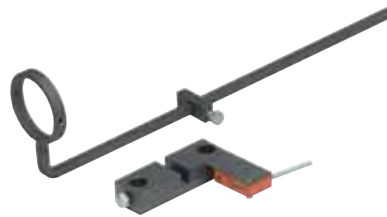

Code	No.	Use in machine No.	
1441345	254680	249, 2804	750

254

EXTENSION CABLE

- For electro-hydraulic pumps 1.1/4", 2" and 3"



380-415 V



230 V

Code	No.	Description	Connection voltage Volt		
4694080	254982	CEE extension cable 5 m	380-415	1.7	1
4694160	254983	CEE extension cable 10 m	380-415	3.1	1
4694240	254984	Safety extension cable 5 m	230	0.9	1
4694320	254985	Safety extension cable 10 m	230	1.6	1

268

INSTALLATION TRIPOD, PIVOTABLE

- Available in 2 sizes
- For GEDORE pipe bender no. 255-260 (standard equipment for benders no. 246, 249 and 2804)
- Enamelled blue



Code	No.	Height	Use	
4599760	268000	480	for manual-hydraulic benders 1.1/4" and 2"	6.2
4599840	268001	680	for manual-hydraulic benders 3" and electric-hydraulic benders 1.1/4" to 3"	17.4



2631

GREY CAST IRON BENDING FORMER UP TO 90°

- For gas and water pipes EN 10255 (DIN 2440/2441)
- Enamelled black



Code	No.	Use in machine No.	Size	Ø mm	r = mm	
4539000	263103	255-260	3/8	17,2	45	0.9
4539190	263105	255-260	1/2	21,3	50	1.3
4539270	263107	255-260	3/4	26,9	75	2.2
4590460	263110	255-260	1	33,7	100	2.3
4590540	263112	255-260	1.1/4	42,4	115	2.4
4539350	263115	257-260	1.1/2	48,3	150	5.3
4539430	263120	257-260	2	60,3	200	6.7
4590620	263125	259-260	2.1/2	76,1	320	21.2
4590700	263130	259-260	3	88,9	380	30.4

2630

STEEL BENDING FORMER UP TO 90°

- For gas and water pipes EN 10255 (DIN 2440/2441)
- For surface-protective bending
- Phosphated



Code	No.	Use in machine No.	Size	Ø mm	r = mm	
4644220	263003	255-260	3/8	17,2	45	1.9
4655850	263005	255-260	1/2	21,3	50	1.3
4655930	263007	255-260	3/4	26,9	75	2.2
4656070	263010	255-260	1	33,7	100	2.3
4656150	263012	255-260	1.1/4	42,4	126	5.8
4656230	263015	257-260	1.1/2	48,3	145	5.3
4656310	263020	257-260	2	60,3	200	11.2
4656580	263025	259-260	2.1/2	76,1	320	21.2
4656660	263030	259-260	3	88,9	380	44.5

2632

COUNTER-SUPPORT (PAIR) UP TO 90°

- For surface-protective bending of uncoated steel pipes and the like
- Hardened, phosphated

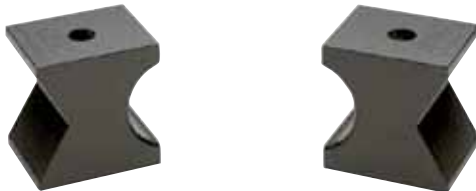

Code	No.	Use in machine No.	
4591510	263267	257	9.1
4591780	263268	258	8.5
4591860	263269	259	15.6
4591940	263270	260	13.6



922



487



2640

STEEL BENDING FORMER UP TO 90°

- For standard-walled distilling pipes EN 10220 (DIN 2448) and metric pipes
- Phosphated



Code	No.	Use in machine No.	Size	Ø mm	r = mm	
4595260	264003	255-260	3/8	17,2	55	2.0
4595340	264005	255-260	1/2	21,3	75	2.5
4595420	264007	255-260	3/4	26,9	90	3.5
4595500	264010	255-260	1	33,7	130	5.4
4595690	264012	257-260	1.1/4	42,4	180	10.2
4596230	264048	257-260	1.1/2	48,3	220	11.8
4596660	264060	259-260	2	60,3	270	21.3
4596900	264076	259-260	2.1/2	76,1	420	49.3
4592750	264014	255-260		14,0	70	2.2
4592830	264015	255-260		15,0	70	2.3
4592910	264016	255-260		16,0	70	2.2
4593050	264018	255-260		18,0	90	3.4
4593130	264020	255-260		20,0	90	3.4
4593210	264022	255-260		22,0	90	3.2
4595770	264025	255-260		25,0	115	3.6
4595850	264030	255-260		30,0	140	6.7
4595930	264032	255-260		32,0	140	6.6
4596070	264038	257-260		38,0	170	8.2
4596150	264044	257-260		44,5	190	10.7
4596310	264051	257-260		51,0	220	15.4
4596580	264057	259-260		57,0	250	15.1
4596740	264063	259-260		63,5	270	22.1
4596820	264070	259-260		70,0	315	23.9

2649

STEEL BENDING FORMER UP TO 90°

- For electrical installation pipes EN 60423
- Phosphated



Code	No.	Use in machine No.	Ø mm	r = mm	
1549626	264912	255-260	M12	115	4.1
4597390	264916	255-260	M16	115	4.1
1549634	264920	255-260	M20	130	5.4
1549642	264925	257-260	M25	160	5.7
1549650	264932	257-260	M32	170	8.7
1549669	264940	257-260	M40	220	10.4
1549677	264950	259-260	M50	250	19.5

2650

STEEL BENDING FORMER UP TO 90°

- For railing pipes with wall thickness from 1.75 to 2.00 mm
- Phosphated



Code	No.	Use in machine No.	Size	Ø mm	r = mm	
4539510	265003	255-260	3/8	17,2	110	3.6
4598280	265005	255-260	1/2	21,3	110	3.6
4598010	265007	255-260	3/4	26,9	137	6.1
4598360	265010	257-260	1	33,7	190	9.4
4545830	265012	257-260	1.1/4	42,4	220	12.4
4644650	265015	259-260	1.1/2	48,3	250	13.7
4644730	265020	259-260	2	60,3	315	25.0



2633

STEEL BENDING FORMER UP TO 180°

- For gas and water pipes EN 10255 (DIN 2440/2441)
- For bends up to 180° piston extension no. 260819 and counter-support no. 263503 - 263504 are required
- Phosphated



Code	No.	Use in machine No.	Size	Ø mm	r = mm	↕
4592240	263307	257-258	3/4	26,9	110	4.7
4592320	263310	257-258	1	33,7	115	6.1
4592400	263312	257-258	1.1/4	42,4	115	6.4
4592590	263315	257-258	1.1/2	48,3	140	9.4

2634

STEEL BENDING FORMER UP TO 180°

- For metric pipes
- For bends up to 180° piston extension no. 260819 and counter-support no. 263503 - 263504 are required
- Phosphated



Code	No.	Use in machine No.	Ø mm	r = mm	↕
4593480	263425	257-258	25	110	3.5
4593560	263428	257-258	28	110	6.6
4593640	263430	257-258	30	110	6.4
4593720	263432	257-258	32	130	7.4
4593800	263435	257-258	35	130	7.1
4593990	263438	257-258	38	150	10.8
4594020	263440	257-258	40	150	10.3
4594100	263442	257-258	42	150	11.9
4594290	263448	257-258	48	150	11.3
4594370	263450	257-258	50	150	10.8

2608

WORKING PISTON EXTENSION

- For producing bends up to 180°
- For bending formers no. 2633 and 2634

Code	No.	↕ (mm)	↕
4696450	260819	160	2.4

2635

COUNTER-SUPPORT (PAIR) UP TO 180°

- For producing hairpin bends up to 180°
- For bending formers no. 2633 and 2634
- Enamelled blue



Code	No.	Use in machine No.	↕
4594610	263503	257	17.5
4594880	263504	258	16.8

2639

BENDING FORMER MSR UP TO 90°

- For multi-layer composite pipes
- A counter-support set no. 2589 is needed for each size
- For surface-protective bending
- Made of plastic



Code	No.	Use in machine No.	Ø mm	r = mm	↕
2302853	263940	258	40	160	1.7
2302861	263950	258	50	200	2.1
2302888	263963	258	63	220	2.4

2589

COUNTER-SUPPORT (PAIR) MSR UP TO 90°

- For surface-protective bending of multi-layer composite pipes
- Made of plastic



Code	No.	Use in machine No.	↕
2302918	258940	258	2.1
2302934	258950	258	2.0
2302942	258963	258	1.9

2670

STRAIGHTENING TOOL

- For steel pipes and scaffold tubes 1.1/2"
- We recommend its use together with the counter-supports no. 267101 - 267102
- Phosphated



Code	No.	Use in machine No.	Size	Ø mm	↕
4697690	267015	257-258	1.1/2	48,3	6.2

2671

STRAIGHTENING COUNTER-SUPPORT (PAIR)

- For steel pipes and scaffold tubes 1.1/2"
- The ideal supplement for straightening tool no. 267
- Phosphated



Code	No.	Use in machine No.	Size	Ø mm	↕
1548379	267101	257	1.1/2	48,3	8.3
1546961	267102	258	1.1/2	48,3	7.7



ECCENTRIC ANGLE BENDERS

max. bending capacities Angle benders 280

	70 mm working height		100 mm working height		120 mm working height	
	cold mm	hot mm	cold mm	hot mm	cold mm	hot mm
Flat steel EN 10058 (DIN 1017) (material strength 370 N/mm ²)	70 x 6 (70 x 10)* (50 x 15)* (30 x 20)*	70 x 10 (70 x 20)* (50 x 25)*	100 x 10 80 x 12 50 x 15 30 x 20	100 x 20 80 x 25	120 x 8 100 x 10 80 x 12 50 x 15 30 x 20	120 x 20 80 x 25
Square steel stock EN 10059 (DIN 1014) (material strength 370 N/mm ²)	6 (22)*	10 (30)*	22	30	22	30
Round steel stock EN 10060 (DIN 1013) (material strength 370 N/mm ²)	6 (25)*	10 (30)*	25	30	25	30
Angled steel stock EN 10056-1 (DIN 1028) (material strength 370 N/mm ²)	70 x 6	70 x 9	100 x 10	100 x 12	120 x 10	120 x 15
CU-flat bars EN 13601 (material strength 250 N/mm ²)	60 x 6 (60 x 30)*		100 x 30		120 x 10 100 x 30	
AL-flat bars EN 754-5 (DIN 1769) (material strength 160 N/mm ²)	70 x 10 (70 x 30)*		100 x 30		120 x 15 100 x 30	

* optional bending tool no. 280072 is necessary

280

ECCENTRIC ANGLE BENDER 70 mm working height

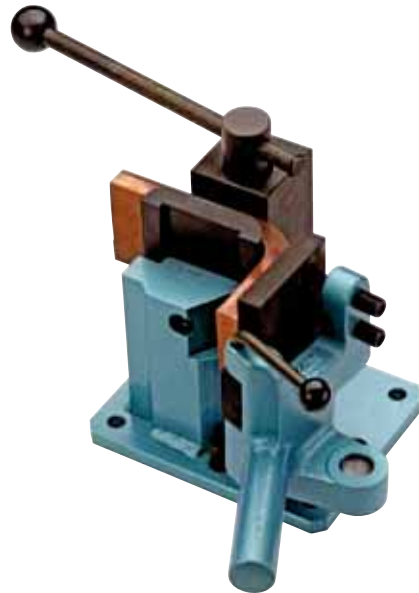

- ✔ For round, flat and angled stocks in steel, copper or aluminium up to 90°
- ✔ With bending tool sharp-edged / r = 4 mm no. 280071 for material thicknesses up to 6 mm
- ✔ Optionally available is the bending tool no. 280072 for greater material thicknesses - see E 280 bending tools
- ✔ With stepless adjustable angle stop no. 280125
- ✔ With length stop 400 mm no. 280130
- ✔ Manual base unit for mounting on a workbench (with optional available angle no. 280250 for vice fixture)



Code	No.	Included in delivery	
4539940	280070	Basic tool 70 mm working height, manual, with bending lever extension no. 268230	24.3

E 280



ACCESSORIES

Code	No.	Description		
2009544	280250	Angle for vice fixture	3.3	1
4644810	280110	Modification set for 100 mm working height	7.5	1
4645380	280174	Modification set for 120 mm working height	9.0	1

E 280

BENDING TOOLS



Code	No.	Description		
4605240	280071	Standard bending tool, sharp-edged / r = 4 mm for material thicknesses up to 6 mm	1.0	1
4605320	280072	Radiused bending tool r = 15 mm / r = 25 mm for material thicknesses up to 30 mm	1.1	1



 **923**



 **487**



280

ECCENTRIC ANGLE BENDER 100 mm working height

- For round, flat and angled stocks in steel, copper or aluminium up to 90°
- With bending tool sharp-edged / r = 4 mm no. 280111 for material thicknesses up to 6 mm
- With bending tool r = 15 mm / r = 25 mm no. 280112 for material thicknesses up to 30 mm
- Optionally available are bending tools for a diversity of applications - see E 280 bending tools
- With stepless adjustable angle stop no. 280125, elektro-hydraulische Geräte mit stufenlos einstellbarer Endabschaltung
- With length stop 400 mm no. 280130
- Manual base unit for mounting on a workbench (with optional available angle no. 280250 for vice fixture)
- Hydraulic equipment mounted on pivotable tripod

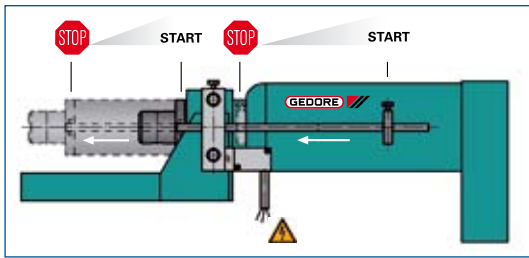
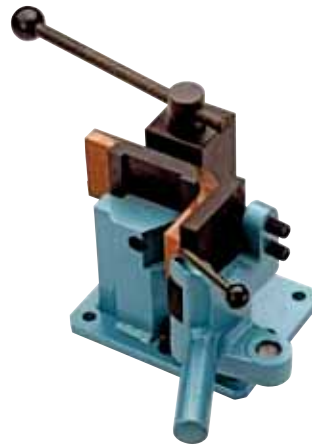

Code	No.	Included in delivery		
4535010	280100	Basic tool 100 mm working height, manual, with bending lever extension no. 268230	26.5	
4606640	280400	Basic tool 100 mm working height, on base plate with tripod No. 280210 and pump, manual-hydraulic no. 254200	102.4	
4606720	280401	Basic tool 100 mm working height, on base plate with tripod No. 280210 and pump, electro-hydraulic, 380-415 V no. 254601	126.9	
1547585	280402	Basic tool 100 mm working height, on base plate with tripod No. 280210 and pump, electro-hydraulic, 230 V no. 254651	126.9	

E 280

ACCESSORIES

► Pumps exchangeable for benders no. 249, 257 and 258

Code	No.	Description		
2009544	280250	Angle for vice fixture	3.3	1
4645380	280174	Modification set for 120 mm working height	9.0	1
4606560	280210	Base plate with tripod for use with hydraulic pump (in connection with no. 254200, no. 254601 or no. 254651)	33.2	1
4584810	254200	Pump 2", manual-hydraulic	21.5	1
1599984	254601	Pump 2" 380-415 V with electrical limiter	41.0	1
1599992	254651	Pump 2" 230 V with electrical limiter	40.8	1

E 280

BENDING TOOLS

Code	No.	Description		
4605400	280111	Standard bending tool, sharp-edged / r = 4 mm for material thicknesses up to 6 mm	1.5	1
4605590	280112	Radiused bending tool r = 15 mm / r = 25 mm for material thicknesses up to 30 mm	1.6	1
4605670	280113	Bending tool for producing saddles and rectangular bends, sharp-edged for material thicknesses up to 3 mm	0.9	1
4605750	280114	Bending tool for producing saddles and rectangular bends, r = 4 mm for material thicknesses up to 6 mm	0.9	1
4605830	280115	Bending tool for making diamond bends	0.7	1
4605910	280116	Bending tool for high saddles (use only in connection with no. 280113 + no. 280114)	1.2	1
4606050	280117	Offset block for narrow saddles	2.4	1

921

487



280

ECCENTRIC ANGLE BENDER 120 mm working height

- ✔ For round, flat and angled stocks in steel, copper or aluminium up to 90°
- ✔ With bending tool sharp-edged / r = 4 mm no. 280161 for material thicknesses up to 6 mm
- ✔ With bending tool r = 15 mm / r = 25 mm no. 280162 for material thicknesses up to 30 mm
- ✔ With stepless adjustable angle stop no. 280125, elektro-hydraulische Geräte mit stufenlos einstellbarer Endabschaltung
- ✔ With length stop 400 mm no. 280130
- ✔ Manual base unit for mounting on a workbench (with optional available angle no. 280250 for vice fixture)
- ✔ Hydraulic equipment mounted on pivotable tripod

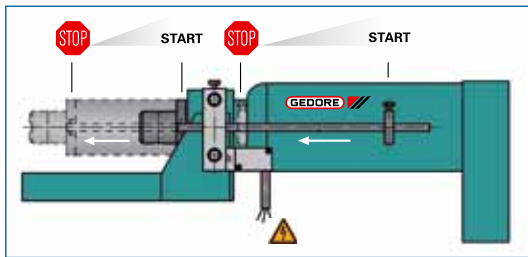



Code	No.	Included in delivery	
4606130	280120	Basic tool 120 mm working height, manual, with bending lever extension no. 268230	27.9
4645620	280420	Basic tool 120 mm working height, on base plate with tripod No. 280210 and pump, manual-hydraulic no. 254200	103.8
4645700	280421	Basic tool 120 mm working height, on base plate with tripod No. 280210 and pump, electro-hydraulic, 380-415 V no. 254601	128.3
1544950	280422	Basic tool 120 mm working height, on base plate with tripod No. 280210 and pump, electro-hydraulic, 230 V no. 254651	128.3

E 280

ACCESSORIES



- ✔ Pumps exchangeable for benders no. 249, 257 and 258

Code	No.	Description		
2009544	280250	Angle for vice fixture	3.3	1
4606560	280210	Base plate with tripod for use with hydraulic pump (in connection with no. 254200, no. 254601 or no. 254651)	33.2	1
4584810	254200	Pump 2", manual-hydraulic	21.5	1
1599984	254601	Pump 2" 380-415 V with electrical limiter	41.0	1
1599992	254651	Pump 2" 230 V with electrical limiter	40.8	1

E 280

BENDING TOOLS



Code	No.	Description		
4645030	280161	Standard bending tool, sharp-edged / r = 4 mm for material thicknesses up to 6 mm	1.8	1
4645110	280162	Radiused bending tool r = 15 mm / r = 25 mm for material thicknesses up to 30 mm	2.0	1



RING BENDING MACHINE

Maximum bending capacities Ring bending machine no. 285

	mm
Flat bar EN 10058 (DIN 1017) (material strength 370 N/mm ²)	50 x 6
Flat bar, vertical EN 10058 (DIN 1017) (material strength 370 N/mm ²)	20 x 5 *
Square iron EN 10059 (DIN 1014) (material strength 370 N/mm ²)	13 x 13
Round bar EN 10060 (DIN 1013) (material strength 370 N/mm ²)	15 *
Angled sections EN 10056-1 (DIN 1028) (material strength 370 N/mm ²)	20 x 20 x 3 *
T-iron EN 10055 (DIN 1024) (material strength 370 N/mm ²)	20 x 20 x 3 *
Pipes	6 x 1.0 upto 18 x 1.5 *

* Please note:

Optional bending tools are required - see E 285

285

RING BENDING MACHINE

- Manual 3-roller ring bending machine
- Vertical operation
- Standard roller set for flat and square stock included
- With two speeds
- Base unit for mounting on a workbench
(with optional available angle no. 285250 for vice fixture)
- Enamelled blue



Code	No.		
4606800	285000	30.0	
Basic tool with standard roller set			

E 285

ACCESSORIES

Code	No.		
2009552	285250	3.3	1
Angle for vice fixture			

267

Straightening tools for scaffold tubes can be found under no. 267 on Pages



561

E 285

BENDING TOOLS



285001 285002 285006-018

Code	No.		
4606990	285001	1.5	1
2-piece upper roller for shaping L and T sections, with leg inside			
4607020	285002	2.7	1
Set 2-piece lower rollers for shaping vertical flat stock, L and T sections, with leg outside			
4607100	285006	2.0	1
1 set rollers for shaping tubes 6x1 mm (1 upper drive roller, 2 lower rollers)			
4607290	285008	2.0	1
1 set rollers for shaping tubes 8x1 mm (1 upper drive roller, 2 lower rollers)			
4607370	285010	1.9	1
1 set rollers for shaping tubes 10x1 mm (1 upper drive roller, 2 lower rollers)			
4607450	285012	1.9	1
1 set rollers for shaping tubes 12x1 mm (1 upper drive roller, 2 lower rollers)			
4607530	285014	1.8	1
1 set rollers for shaping tubes 14x1 mm (1 upper drive roller, 2 lower rollers)			
4607610	285015	1.8	1
1 set rollers for shaping tubes 15x1 mm (1 upper drive roller, 2 lower rollers)			
4607880	285016	1.7	1
1 set rollers for shaping tubes 16x1 mm (1 upper drive roller, 2 lower rollers)			
4607960	285018	1.7	1
1 set rollers for shaping tubes 18x1.5 mm (1 upper drive roller, 2 lower rollers)			

PIPE STRAIGHTENING TOOL

286

PIPE STRAIGHTENING TOOL MSR

- From 14 to 26 mm Ø
- For multi-layer composite pipes (MSR) and soft copper pipes
- For use in a vice or in connection with pivoted and mobile coil reel
- Coil reel suitable for pipe coils from 220 to 1100 mm Ø, maximum pipe-coil height 400 mm

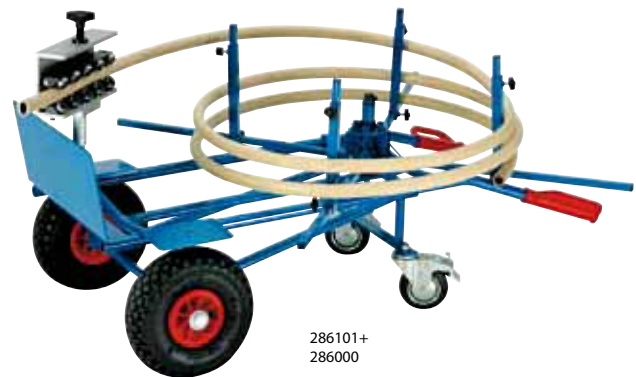

286101+
286000



286000

Code	No.		
1523066	286000	2.5	
Pipe straightening tool, without coil reel			
1531123	286101	22.5	
Coil reel, mobile, without straightening tool			





APPLICATIONS OF THE GEDORE PIPE BENDER

Size	Outer diameter	Wall thickness	No. 2400 2405	No. 241	No. 2415	No. 2420 2423 2424 2425	No. 243	No. 244	No. 2454 2455 2456	No. 246	No. 249	No. 255 256	No. 257 258	No. 259 260	No. 276	No. 278	No. 285
Gas and water pipes EN 10255-M (DIN 2440)																	
1/8"	10,2 mm	2,00 mm															180°
1/4"	13,5 mm	2,35 mm															180°
3/8"	17,2 mm	2,35 mm								180°		90°	90°	90°			180°
1/2"	21,3 mm	2,65 mm								180°		90°	90°	90°			180°
3/4"	26,9 mm	2,65 mm								180°		90°	180°*	90°			180°
1"	33,7 mm	3,25 mm										90°	180°*	90°			
1.1/4"	42,4 mm	3,25 mm										90°	180°*	90°			
1.1/2"	48,3 mm	3,25 mm											180°*	90°			
2"	60,3 mm	3,65 mm											90°	90°			
2.1/2"	76,1 mm	3,65 mm												90°			
3"	88,9 mm	4,05 mm												90°			
Gas and water pipes EN 10255-H (DIN 2441)																	
1/8"	10,2 mm	2,65 mm															180°
1/4"	13,5 mm	2,90 mm															180°
3/8"	17,2 mm	2,90 mm										90°	90°	90°			180°
1/2"	21,3 mm	3,25 mm										90°	90°	90°			180°
3/4"	26,9 mm	3,25 mm										90°	180°*	90°			180°
1"	33,7 mm	4,05 mm										90°	180°*	90°			
1.1/4"	42,4 mm	4,05 mm										90°	180°*	90°			
1.1/2"	48,3 mm	4,05 mm											180°*	90°			
2"	60,3 mm	4,50 mm											90°	90°			
2.1/2"	76,1 mm	4,50 mm												90°			
3"	88,9 mm	4,85 mm												90°			
Distilling pipes EN 10220 (DIN 2448)																	
3/8"	17,2 mm	1,80 mm										90°	90°	90°			180°
1/2"	21,3 mm	2,00 mm										90°	90°	90°			180°
	25,0 mm	2,00 mm										90°	90°	90°			180°
3/4"	26,9 mm	2,30 mm										90°	90°	90°			180°
	30,0 mm	2,60 mm										90°	90°	90°			180°
	31,8 mm	2,60 mm										90°	90°	90°			
1"	33,7 mm	2,60 mm										90°	90°	90°			
	38,0 mm	2,60 mm											90°	90°			
1.1/4"	42,4 mm	2,60 mm											90°	90°			
	44,5 mm	2,60 mm											90°	90°			
1.1/2"	48,3 mm	2,60 mm											90°	90°			
	51,0 mm	2,60 mm											90°	90°			
	57,0 mm	2,90 mm												90°			
2"	60,3 mm	2,90 mm												90°			
	63,5 mm	2,90 mm												90°			
	70,0 mm	2,90 mm												90°			
2.1/2"	76,1 mm	2,90 mm												90°			



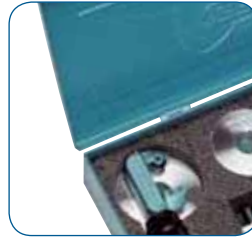
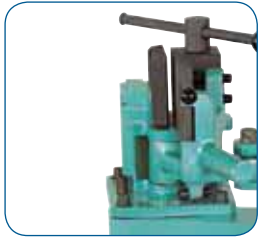

APPLICATIONS OF THE GEDORE PIPE BENDER

Size	Outer diameter	Wall thickness	No. 2400 2405	No. 241	No. 2415	No. 2420 2423 2424 2425	No. 243	No. 244	No. 2454 2455 2456	No. 246	No. 249	No. 255 256	No. 257 258	No. 259 260	No. 276	No. 278	No. 285	
Electrical installation pipes EN 60423																		
M 12	12,0 mm	1,00 mm										90°	90°	90°	90°	180°		
M 16	16,0 mm	1,00 mm										90°	90°	90°	90°	180°		
M 20	20,0 mm	1,00 mm										90°	90°	90°	90°	180°		
M 25	25,0 mm	1,20 mm										90°		90°	90°	180°		
M 32	32,0 mm	1,20 mm										90°		90°	90°	180°		
M 40	40,0 mm	1,20 mm										90°		90°	90°			
M 50	50,0 mm	1,20 mm										90°		90°				
Banister-rail tubes																		
3/8"	17,2 mm	1,75 mm										90°	90°	90°	90°	180°		
1/2"	21,3 mm	1,75 mm										90°	90°	90°	90°	180°		
3/4"	26,9 mm	2,00 mm										90°	90°	90°	90°	180°		
1"	33,7 mm	2,00 mm										90°		90°	90°			
1.1/4"	42,4 mm	2,00 mm										90°		90°	90°			
1.1/2"	48,3 mm	2,00 mm										90°		90°				
2"	60,3 mm	2,00 mm												90°				
Multi-layer composite pipes																		
	14,0 mm	2,00 mm				90°			90°	180°					180°			
	16,0 mm	2,00 mm				90°			90°	180°	90°				180°			
	18,0 mm	2,00 mm	180°			90°			90°	180°	90°				180°			
	20,0 mm	2,00 mm	180°			90°			90°	180°	90°				180°			
	26,0 mm	3,00 mm							90°						180°			
	32,0 mm	3,00 mm							90°		90°				180°			
	40,0 mm	3,50 mm									90°		90° (258)					
	50,0 mm	4,00 mm									90°		90° (258)					
	63,0 mm	4,50 mm											90° (258)					
Copper pipes EN 1057 half-hard in mm			12-22*			10-22*				6-28*	12-35				6-22		6-18*	
Copper pipes EN 1057 soft in mm			12-22	4,75-12	4,75-10	10-22*	6-16*	10-22	5-22	6-28*	12-35				6-22		6-18*	
Sheathed copper pipes in mm			*			*	*		*		*				*			
Thin-walled NF pipes in mm			12-22	4,75-12	4,75-10	10-22*	6-16*	10-30		12-28*	12-42				10-32			
Hydraulic pipes EN 10305-1 (DIN 2391) in mm			10-15 (2405)	4,75-12		10-18*	6-12*	10-22	5-18*	12-22*	12-42	14-32*	14-50*	14-76,1*	6-28*	3-25*	6-18*	
Precision steel pipes EN 10305-3 (DIN 2394) in mm			10-15 (2405)	4,75-12		10-18*	6-12*	10-22	5-18*	12-22*	12-54	14-32*	14-50*	14-76,1*	6-28*	3-25*	6-18*	
Stainless steel pipes EN 10088-3 (DIN 17 440) in mm						10-18*			5-18*	12-22*	12-42*	14-32*	14-40*	14-60,3*	6-28*	3-25*		

*) depending on size / finish / pipe properties - see article description



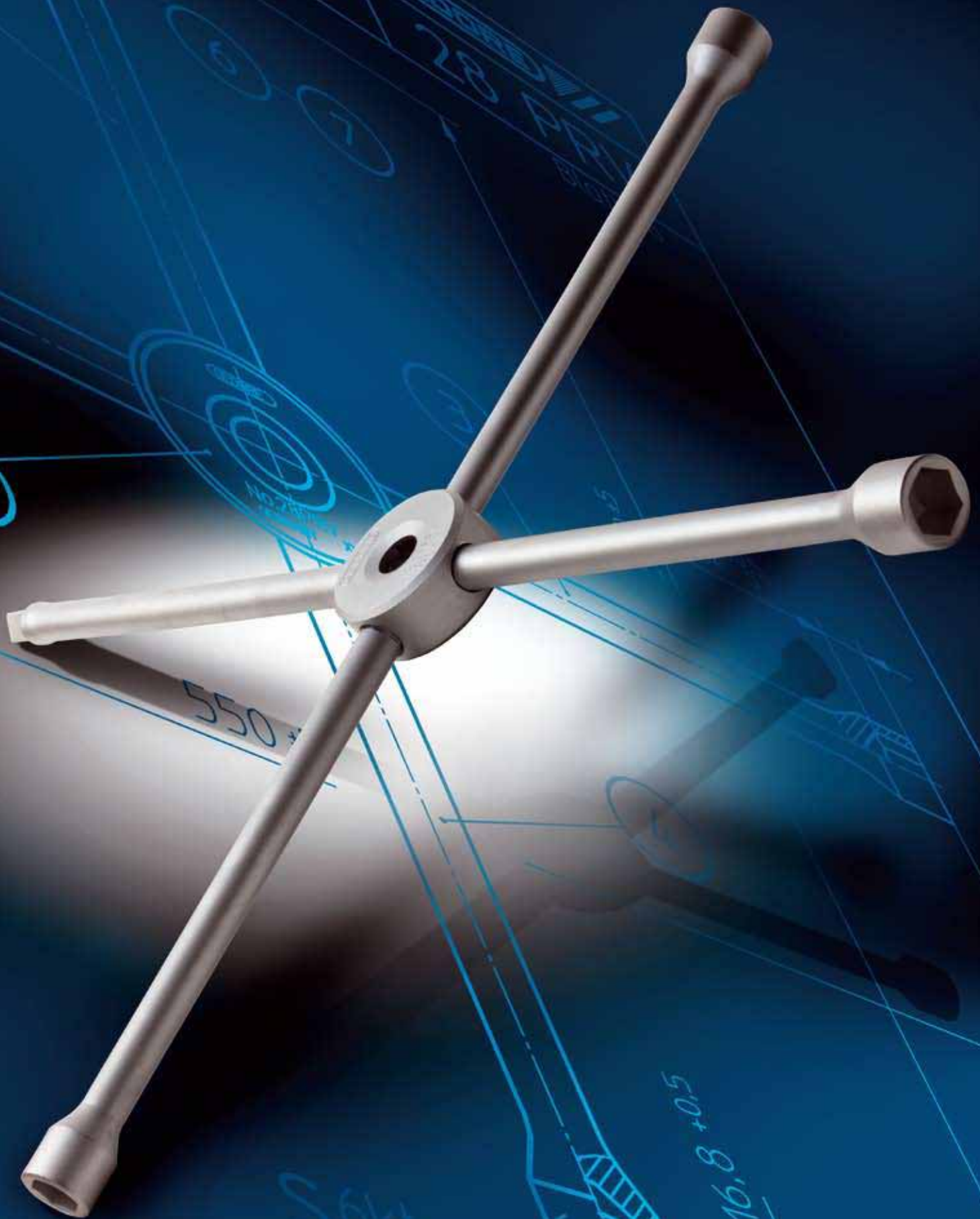













AUTOMOTIVE TOOLS

SPECIALISED TOOLS



++ FOR SPECIAL PURPOSES+



SERVICE / FEATURES		570 - 571
TYRE FITTING / REMOVAL		572 - 574
BRAKES		574
OIL SERVICE / V-BELTS / FILTERS		575
PISTONS / VALVES		576 - 577
ELECTRIC SYSTEM		578 - 579
SPARK PLUGS		580 - 581
LIFTERS		582
EXHAUST / ENGINE / VARIOUS		583
CAR BODY WORK		584 - 585
BODYWORK TOOL SETS / SHEET METAL FORMING TOOLS		586
EQUIPMENT		587



AUTOMOTIVE SPECIAL TOOLS



588 - 589

++ AUTOMOTIVE TOOLS ON REQUEST: -----
 MOBILE TOOL CABINET AND TOOL CHEST WITH MOTORCYCLE TOOL SET ++

- ▶ Ideal for service, maintenance and repair work
- ▶ Developed from everyday workshop routine
- ▶ Universal multi-use kit
- ▶ Metric and/or imperial tools
- ▶ With Check-Tool-system

**365-PIECE
 2005-2430 MOT**



2005...



CT-43 KTX

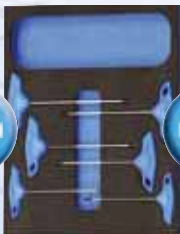

CT-42 TX

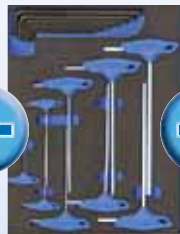

CT-DT 42

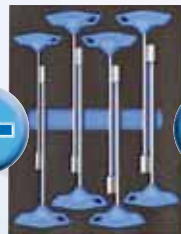

CT-33T



CT-D 20



CT-D 30

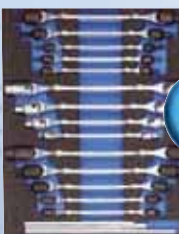

CT-TX

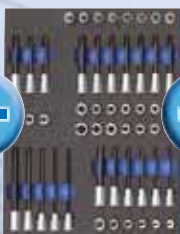

CT-30 TX

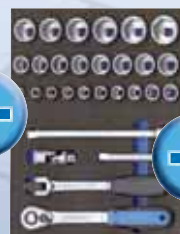

CT-D 19



CT 7-7R



CT 8000





MOBILE TOOL CABINET WITH CAR TOOL SET

++

**258-PIECE
2005 AUTO**



2005...

CT-119

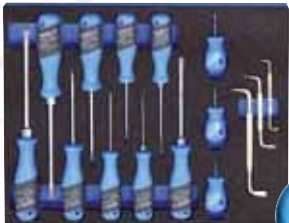

CT-2160



CT-8000



CT 2-7



CT-U-20



CHECK-TOOL-SYSTEM

- ✔ 2-colour plastic insert provides easy optical check of completeness
- ✔ Ideally suited for use in sensitive areas, where it is essential to ensure that no tools are left behind
- ✔ Underlay blue, overlay black. A visible blue pocket indicates a missing tool
- ✔ Each tool is securely held in its own pocket, prevented from slipping and protected from damage
- ✔ Grip recesses facilitate removal of the tools
- ✔ Clearly visible tool contours simplify replacement into the correct pocket
- ✔ Resistant to oil and grease

Suitable for tool trolley 2005 and workbench 1504 XL



TYRE FITTING / REMOVAL

Four-way wheel wrench

- Hot forged hexagon
- The collar, typical of GEDORE 4-way wheel wrenches, enlarges the welding area. The positive-fit joint remains solid even under extreme loading.



28 PKH

2-WAY WHEEL WRENCH FOR CARS

- An indispensable tool for all usual car wheel nuts
- With a protective central reinforcement (DBGM = German utility patent)
- Practical and strong, with long lever arm, a space-saver in the car boot
- GEDORE vanadium steel 31CrV3, chrome-plated
- Dimensions: 410 x 260 mm



Code	No.	Ø mm	Ø mm	g	l
6227290	28 PKH	17x19 (3/4")	26x28,5	1020	1

28 PR + 28 PRV

UNIVERSAL 4-WAY WHEEL WRENCH for cars and small trucks

- Acc. to DIN 3119, ISO 6788
- With solid turned centre, for the car and truck workshop
- With extra long lever arm and great range of sockets
- GEDORE vanadium steel 31CrV3, chrome-plated
- Dimensions: 550 x 550 mm

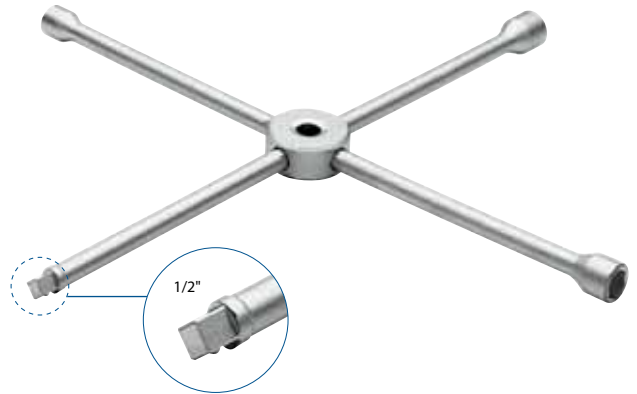

Code	No.	Ø mm	Ø mm	g	l
6227530	28 PR	17x19 (3/4")x21x24	26x28,5x30,5x35,5	2315	1
6227880	28 PRV	17x19 (3/4")x21x1/2" 4kt	26x28,5x30,5x17,5	2255	1

28 PU + 28 PUV

4-WAY WHEEL WRENCH FOR CARS

- For car wheel nuts in metric and inch sizes
- Acc. to DIN 3119, ISO 6788
- With protective central reinforcement (DBGM = German utility patent)
- GEDORE vanadium steel 31CrV3
- GEDORIT silver powder-coated
- CS = chrome-plated
- Dimensions: 420 x 420 mm

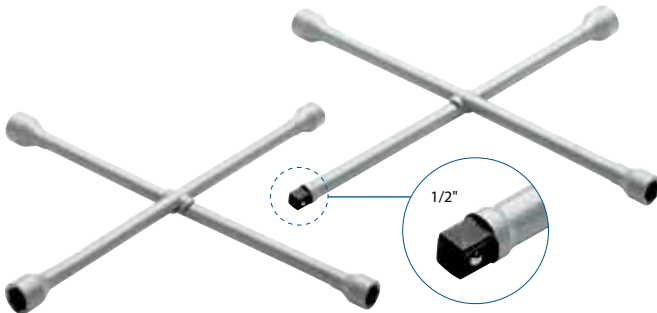

Code	No.	Ø mm	Ø mm	g	l
6227610	28 PU	17x19 (3/4")x21x11/16"	26x28,5x30,5x26	1285	1
6227960	28 PU CS	17x19 (3/4")x21x11/16"	26x28,5x30,5x26	1290	1
6228260	28 PUV	17x19 (3/4")x21x1/2" 4kt	26x28,5x30,5x17,5	1315	1



8573-00 • 4550-20



**240
-
241
252**

- For the controlled tightening of wheel nuts or studs, we recommend torque wrenches
- For truck wheels, we specially recommend the DR-LKW torque wrench
- For tightening and wrench sizes see tables in annex





28 CU

4-WAY WHEEL WRENCH FOR SMALL TRUCKS

- For delivery vans and light trucks, buses and tractors
- Acc. to DIN 3119, ISO 6788
- GEDORE vanadium steel 31CrV3
- GEDORIT silver powder-coated
- Dimensions: 600 x 600 mm



Code	No.	Ø mm	Ø mm	↕	📦
6228500	28 CU	19x24x22x27 (3/4x15/16x7/8x1.1/16")	28,5x32x34,5x38,5	3155	1

28 L - LM - LV

4-WAY WHEEL WRENCH FOR TRUCKS

- For trucks, agricultural machines, tractors and industrial uses
- Acc. to DIN 3119, ISO 6788
- GEDORE vanadium steel 31CrV3
- GEDORIT silver powder-coated
- Dimensions: 750 x 750 mm

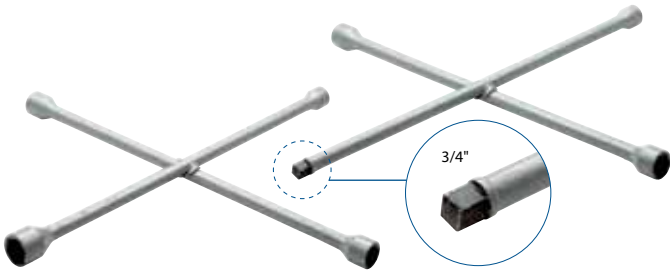

Code	No.	Ø mm	Ø mm	↕	📦
6228770	28 LM	24x27x30x32	34,5x38,5x42x45	5555	1
6228850	28 L	24x27x32x38	34,5x38,5x45x52	5610	1
6229150	28 LV	24x32x27x3/4" 4kt	34,5x45x38,5x26	5515	1

28 LR + 28 LRV

4-WAY WHEEL WRENCH FOR TRUCKS

- For trucks and heavy machines
- With turned centre, especially sturdy
- GEDORE vanadium steel 31CrV3, chrome-plated
- Dimensions: 750 x 750 mm

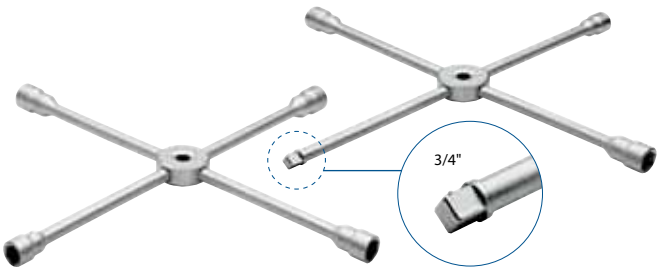

Code	No.	Ø mm	Ø mm	↕	📦
6228930	28 LR	27x30x32x33	40x44x46x46	6085	1
6228420	28 LRV	27x30x32x3/4" 4kt	40x44x46x26	5980	1

28 LRZ

4-WAY WHEEL WRENCH FOR TRUCKS

- For trucks and heavy machines
- With solid centre
- With plug-in arms and pin locking
- For practical stowage in buses and trucks
- GEDORE vanadium steel 31CrV3, chrome-plated. DBGM.G 8409214.9 (DBGM = German utility patent)
- Dimensions: 750 x 750 mm
- Complete in sturdy metal case with handle, dimensions: 550 x 125 x 55 mm

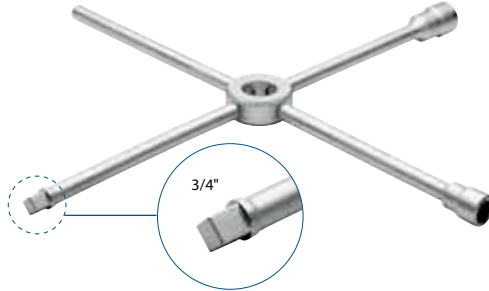

Code	No.	Contents	↕	📦
6228690	28 LRZ	E-28 LRZ-MS -DS -3/4" -27 -32 2161 PH 1	7,5	1

Code	No.	Description	↕ mm	Ø	↕	📦
6224430	E-28 LRZ-MS	Centre piece 35 mm, d 88 mm	35	88	976	1
6224510	E-28 LRZ-DS	Lever handle 354 mm, d 22 mm	354	22	1022	1
6224780	E-28 LRZ-3/4	Arm 3/4", 354 mm	354	26	1096	1
6224860	E-28 LRZ-24	Arm 24 mm, 354 mm	354	36	1060	1
6224940	E-28 LRZ-27	Arm 27 mm, 354 mm	354	40	1154	1
6225080	E-28 LRZ-30	Arm 30 mm, 354 mm	354	44	1154	1
6225160	E-28 LRZ-32	Arm 32 mm, 354 mm	354	46	1300	1
1482440	2161 PH 1	Screwdriver Stubby PH 1	75		33	10

28 PX

DOUBLE ENDED WHEEL WRENCH

- With extra long shaft and offset heads
- Especially handy and with great lever action
- A space-saver in the car boot
- Chrome-plated



Code	No.	Ø mm	Ø mm	↕ mm	↕	📦
6228340	28 PX	17x19 (3/4")	26x28,5	460	775	1

27

WHEEL SOCKET WRENCH FOR TRUCKS

- With great head depth, for protruding bolts, without tommy bar
- GEDORE vanadium steel 31CrV3, chrome-plated
- Please order tommy bar 27 D separately

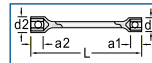

Code	No.	Ø mm	Ø AF	L	a ₁	a ₂	d ₁	d ₂	Ø	↕	📦
6225240	27 24x27	24 x 27	15/16 x 1.1/16	400	34,5	34,5	36	40		1148	1
6220010	27 27x32	27 x 32		400	34,5	34,5	40	46		1453	1
6220280	27 28x32	28 x 32		400	34,5	34,5	41	46		1134	1
6220360	27 28x33	28 x 33		400	34,5	34,5	44	47		1424	1
6225910	27 30x32	30 x 32	1.3/16 x 1.1/44	400	34,5	34,5	44	46		1459	1
6220440	27 30x33	30 x 33		400	34,5	34,5	44	47		1442	1
6225400	27 32x38	32 x 38	1.1/4 x 1.1/2	400	34,5	34,5	46	54		1509	1
6227100	27 D			630					18	1260	1



8568 -35 DREMOMETER DR LKW



242







38

TYRE LEVER

- ▶ Profiled pattern, forged from solid stock
- ▶ With protective surfaces for light-alloy wheels
- ▶ GEDORE vanadium steel 31CrV3, chrome-plated





Code	No.	↳mm↳	↳Inch↳		
6332320	38 8	200	8	99	10
6332400	38 12	305	12	221	10
6332670	38 16	400	16	405	10
6332830	38 20	500	20	602	1
6332910	38 24	610	24	927	1

39

TYRE LEVER heavy-duty pattern, for trucks

- ▶ Heavy-duty, offset pattern
- ▶ GEDORE vanadium steel 31CrV3, chrome-plated





Code	No.	↳mm↳	↳Inch↳		
6333050	39	610	24	1365	1

631

HUBCAP REMOVING TOOL

- ▶ For damage-free removal of chrome-plated hubcaps
- ▶ Chrome-plated





Code	No.	↳mm↳		
6520830	631	150	166	1

8276

BALANCE WEIGHT PLIERS

- ▶ For removing, cutting, and attaching balancing weights
- ▶ GEDORE vanadium steel 31CrV3



Code	No.	↳mm↳	↳Inch↳		
6739350	8276-250 C	250	10	386	1



BRAKES

135

BRAKE SPRING PLIERS

- ▶ For drum brakes
- ▶ With special holder and support crown, particularly suitable for glued brake linings
- ▶ GEDORE vanadium steel 31CrV3, chrome-plated





Code	No.	↳mm↳	↳Inch↳		
6405300	135 13	330	13	389	1
6405490	135 19	480	19	956	1

135

BRAKE SPRING PLIERS heavy-duty pattern

- ▶ For drum brakes
- ▶ With replaceable spring hooks (E-135 20) and hand protectors
- ▶ GEDORE vanadium steel 31CrV3, chrome-plated





Code	No.	↳mm↳	↳Inch↳		
6400180	135 20	500	20	1058	1
5400480	E-135 20			16	1

1600

PLIERS FOR BRAKE CABLE SPRINGS

- ▶ For the installation and removal of handbrake cables





Code	No.	↳mm↳	↳Inch↳		
6630340	1600-402	227	8.1/2	234	1

643

BRAKE CALIPER BRUSH

- ▶ For cleaning all brake calipers
- ▶ With blue plastic handle





Code	No.	↳mm↳		
6531440	643	225	94	5

8726

BRAKE CALIPER FILE



Code	No.	↳mm↳	↳Inch↳		
6770780	8726	260	10	131	1



**OIL SERVICE****299****DRAIN PLUG WRENCH**

- For square plugs on engine sumps and oil drums, in nine common sizes
- GEDORE vanadium steel 31CrV3, chrome-plated
- 5 square sizes: 8.7, 9.5, 10.5, 11.5, 13 mm
- 4 tapered sizes: 6.8-8.7, 10.5-13, 15.2-18, 16.5-19 mm
- One screwdriver blade: 5.5 x 18 mm



Code	No.	↳mm↵	↕	📦
6464580	299	220	459	5

298**OIL CAN**

- 298-00 / 298-01** Plastic oil can with sliding brass tube and cap
- 298-02** simple oil can in plastic



Code	No.	litre	Pint	↕	📦
6390010	298-00	0.250	1/2	979	1
6390280	298-01	0.125	1/4	74	1
6390360	298-02	0.025	1/16	10	1

298-04**OIL CAN**

- Strong, cast iron pattern with pump, 300 ml



Code	No.	litre	Pint	↕	📦
6390520	298-04	0.3	5/8	492	1

298-05**OIL CAN**

- For working in every position
- With double-stroke metal pump
- Strong, cast iron pattern, 300 ml



Code	No.	litre	Pint	↕	📦
6390600	298-05	0.3	5/8	453	1

V-BELTS / FILTERS**37 + 37 V****UNIVERSAL FILTER WRENCH**

- For all usual oil filters and round screwed unions
- Adjustable metal strap, nickel-plated
- 37** with handle
- 37 V** with 1/2" square drive for all 1/2" tools



Code	No.	mm	↳mm↵ (appr.)	↕	📦
6327670	37	80-110	285	349	1
6327750	37 V	80-110	150	265	1

36**STRAP WRENCH**

- With strong, non-slip fabric strap, extra wide = 25 mm
- 36 1-140 made from C45 steel
- 36 2-200 made from GEDORE vanadium steel 31CrV3
- Chrome-plated
- Spare straps E-36 1 / E-36 2



Code	No.	mm	↳mm↵	Ø mm	Ø inch	↕	📦
6327320	36 1-140	25	220	140	9/64	278	1
6327400	36 2-200	25	285	200	13/64	578	1
5327380	E-36 1-140	25	480			62	1
5327460	E-36 2-200	25	900			104	1

36 Z**SPECIAL STRAP WRENCH**

- For tightening and counter-holding V-belt pulley wheels



Code	No.	↳mm↵	Ø mm	Ø inch	↕	📦
6320070	36 Z-140	257	160	5/32	379	1
1380613	E-36 Z-140				80	1

**920 · 921 · 922****487**



PISTONS / VALVES

654

VALVE GRINDER

- ✔ With automatic lapping direction reversal
- ✔ For clamping in hand drills
- ✔ Supplied with suction cups 652-20, 25, 30 and 37 mm



Code	No.	↳mm↳	Ø mm	↳↳	↳
6535270	654	135	65	750	1

653

VALVE LAPPING TOOL

- ✔ Hand-held type with suction cup 652-25
- ✔ Beech wood handle



Code	No.	↳mm↳	Ø mm	↳↳	↳
6532680	653	225	25	50	1

652

SPARE RUBBER SUCTION CUP for 653 and 654



Code	No.	↳mm↳	Ø mm	↳↳	↳
6530120	652-20	38	20	10	1
6532410	652-25	38	25	11	1
6530200	652-30	38	30	12	1
6530390	652-37	38	37	16	1

124

PLIERS FOR VALVE SEALS

- ✔ For pulling valve shaft sealing rings and removing valve spring supports
- ✔ For VW Audi, BMW, Mercedes, Opel, Ford, Nissan etc.
- ✔ Gun-metal finish, handles chrome-plated



Code	No.	↳mm↳	↳Inch↳	↳↳	↳
6399310	124	250	10	348	1

128

VALVE SPRING COMPRESSOR

- ✔ For overhead valve engines
- ✔ With one pair each of straight and offset hooks
- ✔ Bright nickel-plated



Code	No.	↳mm↳	↳Inch↳	mm	↳Inch↳	↳↳	↳
6398500	128 2-225	290	11.1/2	60-225	2.3/8-9	1.3	1
6398690	128 1-280	390	15	120-280	4.3/4-11.1/2	3.2	1

E-128

HOOKS (PAIR)



Code	No.	Description	↳↳	↳
5398720	E-128 1	Hooks, pair, straight pattern for no. 128 1-280	111	1
5398560	E-128 2	Hooks, pair, straight pattern for no. 128 2-225	118	1
5398990	E-128 1A	Hooks, pair, offset pattern for no.c	114	1
5398640	E-128 2A	Hooks, pair, offset pattern for no. 128 2-225	116	1

125

PISTON RING COMPRESSOR

- ✔ In special band spring steel, with continuous adjustment
- ✔ With clamping wrench



Code	No.	↳mm↳	↳Inch↳	Ø mm	↳↳	↳
6396720	125 0	50	2	40-75	115	1
6396800	125 1	80	3	57-125	257	1
6396990	125 2	80	3	90-175	294	1
6397020	125 3	165	6.1/2	90-175	548	1

126

PISTON RING PLIERS

- ✔ With prism holder for secure fitting of piston rings
- ✔ With adjusting screw
- ✔ Bright nickel-plated



Code	No.	↳mm↳	↳Inch↳	Ø mm	↳↳	↳
6397100	126 0-60	210	8.1/4	30-60	158	1

126

PISTON RING PLIERS

- ✔ For securely fitting piston rings
- ✔ Handles blue coated
- ✔ Bright nickel-plated



Code	No.	↳mm↳	↳Inch↳	Ø mm	↳↳	↳
6397370	126 1-100	200	8	55-100	296	1
6397450	126 2-120	240	9.1/2	80-120	344	1
6397530	126 3-160	240	9.1/2	110-160	402	1



**127****PISTON RING PLIERS**

- With prism holder for safe piston ring spreading
- In special steel
- Prism holders hardened
- Chrome-plated, tips gun-metal finish



Code	No.	mm	inch	mm	mm	mm
6397610	127	220	8.5/8	60-160	207	1

132-4**HOSE CLAMP PLIERS CLIC**

- With revolving locking bolts for CLIC hose clamps
- To open or close, just turn the plier by 180 degrees
- The pivotable bolts enable the usage even in hard-to-reach areas
- CLIC hose clamps are used on rubber and silicone hoses (e.g. automotive industry for fuel-, oil- and cooler-systems)
- Made from steel sheet, nickel-plated



Code	No.	mm	mm	mm	mm
1894404	132-4	210	181		1

132**HOSE CLAMP PLIERS**

- For self-clamping hose clamps
- Handles chrome-plated



Code	No.	mm	inch	mm	mm
6399900	132	220	8.3/4	215	1

134**HOSE CLAMP PLIERS**

- With self-adjusting joint, DBGM (= German utility patent)
- Angled jaw
- Bright nickel-plated, joint gun-metal finish



Code	No.	mm	inch	mm	mm
6391330	134	180	7	411	1

132-2 / -3**HOSE CLAMP PLIERS**

- 132.2: Rotating v-jaws for spring hose clamps with flat butt ends
- The pliers allow the clamp to be opened and closed without damaging the hose, even in hard-to-reach areas
- 132.3: Rigid v-jaws
- For use on VAG-vehicles (e.g. VW, Audi, Škoda, Seat)
- Made from steel sheet, nickel-plated



Code	No.	mm	mm	mm	mm
1894382	132-2	207	192		1
1894390	132-3	195	165		1

134 B**HOSE CLAMP PLIERS**

- Bowden-cable operation
- With self-adjusting joint, DBGM (= German utility patent)
- Angled jaw
- Bright nickel-plated, joint gun-metal finish

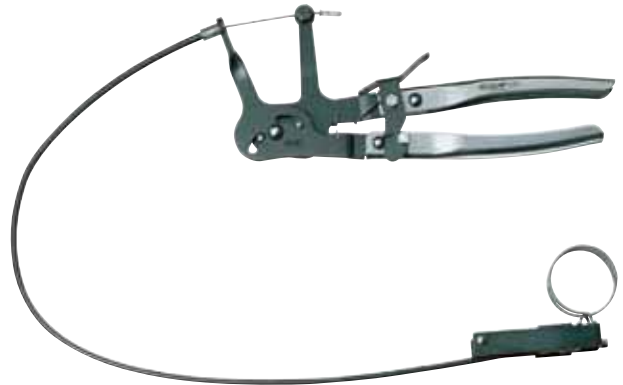

Code	No.	mm	inch	mm	mm
6390950	134 B	180	7	596	1

132 CLIC**HOSE CLAMP PLIERS**

- For CLIC-R hose clamps
- Polished, bright nickel-plated, joint gun-metal finish
- Forged execution for clamp diameter 5 - 30 mm



Code	No.	mm	inch	mm	mm
1396714	132 CLIC	180	7	247	1

8317**BOWDEN CABLE CUTTER**

- For cutting wire rope up to 2 mm diameter and bowden-cable sleeves up to 5 mm diameter
- Crimping of bowden-cable sleeves and end-sleeves 1.5 mm and 2 mm
- For medium hard wire
- With opening spring, transport lock and width adjustment
- Induction-hardened cutting edges
- Innovative GEDORE cutting form produces a precision cut
- Low overall weight



Code	No.	mm	mm	mm	mm
2011638	8317-160 JC	170	150		1



ELECTRIC SYSTEM

S 89

TERMINAL-EXTRACTION TOOLS

- Tools for the damage-free removal of contacts in cable looms
- **S 8905** - Basic set 5 pieces for cars
- **S 8910 UNI** - Universal set 10 pieces for cars and trucks
- **S 8910 LKW** - 10 pieces for trucks and HGV



S 8905

Code	No.	Contents	574
1976443	S 8905	E-8703-5 E-8704-5 E-8804-0 E-8807-0 E-8908-9	579
1976451	S 8910 UNI	E-8703-5 E-8704-5 E-8705-0 E-8804-0 E-8806-9 E-8807-0 E-8905-8 E-8908-9 E-9002-8 E-9300-5	731
1976478	S 8910 LKW	E-8703-5 E-8706-5 E-8706-7 E-9000-2 E-9001-4 E-9903-2 E-2105-4 E-2409-0 E-2500-8 E-2502-0	765



S 8140 A



338

TERMINAL-EXTRACTION TOOLS

- Art-No. Contact / Measure / for contact / for which vehicles**
- **E-8703-5** **Round plug 1.6 for pins and sockets** / DC, BMW, trucks, buses
 - **E-8704-5** **Round plug 3.5 for pins and sockets** / DC, Fiat, Opel, trucks, buses
 - **E-8705-0** **Round plug 2.5** / DC, BMW, Opel, trucks, buses
 - **E-8706-5** **Round plug 4.0 ABS contact** / Trucks, buses: Iveco, Mack, MAN, MB, Renault, Scania, Volvo
 - **E-8706-7** **Mounting sleeve ABS contact** / Trucks, buses: Iveco, Mack, MAN, MB, Renault, Scania, Volvo
 - **E-8804-0** **Flat plug 2.8 JPT for Junior (Power) Timer contacts** / BMW, VW-Audi, trucks, buses
 - **E-8807-0** **Flat plug 5.8 SPT contacts (AMP)** / BMW, Opel, trucks, buses
 - **E-8806-9** **Flat plug Micro/MQS** / BMW, Opel, trucks, buses
 - **E-8905-8** **Flat plug 2.8/5.8 JT/Ducon** / DC, BMW, Renault, trucks, buses
 - **E-8908-9** **Flat plug 2.8/5.8 Standard-Timer contact with snap-in pin** / DC, BMW, Renault, trucks, buses
 - **E-9000-2** **Flat plug contacts with 2 snap-in pins** / Trucks: Mack, MB, Renault, Scania, Volvo
 - **E-9002-8** **Flat plug 2.8/5.8 JT/Ducon** / Cars, trucks, buses
 - **E-9001-4** **Solder contact 2.8** / Trucks: Mack, MB, Renault, Volvo
 - **E-9300-5** **Flat plug 1.5 MT II + III** / BMW, Opel, Skoda, trucks, buses
 - **E-9903-2** **Flat plug 1.6 Micro-Timer, I-Contact, JT, Ducon, GAE** / Cars: Fiat, Ford, Mazda, Opel, PSA, Renault, Saab, VW-Audi; Trucks: Fendt, Mack, Renault, Scania, Volvo
 - **E-2105-4** **Round plug 1.5 MKR / MKS** / Trucks: Mack, MAN, Renault, Volvo
 - **E-2409-0** **Round plug 2.5 VKR contact** / Trucks: Mack, MAN, Renault, Volvo
 - **E-2500-8** **Flat plug 0.64 Bosch BMK** / Trucks: Iveco, Mack, MB, MAN, Renault, Scania, Volvo
 - **E-2502-0** **Flat plug universal for secondary locking** / Trucks: Iveco, Mack, MB, MAN, Renault, Scania, Volvo

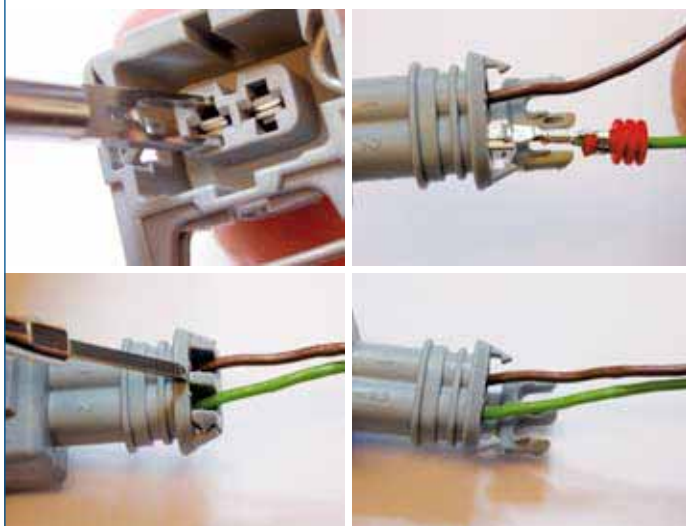

Terminal-extraction tools

- Complex cable connections are used everywhere in the modern automotive sector
- To avoid having to thread a new cable loom when damage occurs, the connector can be opened and the faulty connection repaired
- Terminal-extraction tools enable non-destructive removal of the electrical connector pin from its casing
- The tool release the lock between the pin and casing without damaging the components

Tips for use:

- The connection must be disconnected from the battery. It must not be live!
- First of all, open the additional secondary sealing. Secondary covers can take the form of caps, lids or slides. In many cases, they are a different colour from the actual pin.
- Push on the ends of the terminal-extraction tool as far as they will go, applying light pressure. Use the cable to press against.
- After unlocking, pull the pin on the cable out of the casing.
- After separating the pin and casing, check the components for damage, and replace as required.
- Do not use terminal-extraction tools as levers!
- Secondary cover closed
- Secondary cover open
- Insert flat pin tool into unlocking channel and release pin
- Remove released pin from casing



4612

VOLTAGE TESTER

- For 6-48 Volt
- Use: automobile, utility vehicles
- LED displays the voltage in the area of 12, 24, 48 V as well as the polarity
- For work in confined areas
- TÜV and GS tested, IEC / EN 61010-1 (DIN VDE 0411)
- Measurements: 145 x 25 x 16mm
- Protection classification IP40, protection class III



Code	No.	Stk	Ein
1881647	4612	120	1

610

BATTERY SERVICING TOOLS 13 pieces

- Large assortment of tools for battery care and servicing
- In practical sheet steel case with two plastic inserts
- With acid-resistant primer, stove enamelled blue
- Dimensions: 400 x 220 x 140 mm



Code	No.	Contents	Stk	Ein
6523260	610	Open ended spanner No. 6 10x13 Water pump pliers No. 145 10 C Screwdriver No. 2150 6.5 Cleaning brush No. 601 Cell filler No. 604 Acid tester No. 605 Battery terminal puller No. 1.12/01 Battery terminal opener No. 607 Battery carrying strap No. 609 Universal canister No. 611 Plastic box No. 611 A Cable knife No. 4522 Insulating tape No. 4629	4565	1

601 - 609

BATTERY SERVICING TOOLS

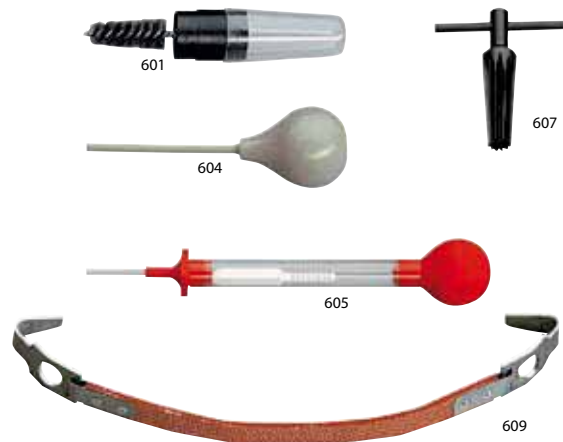

Code	No.	Description	Stk	Ein
6522100	601	Battery cleaning brush	85	5
6522450	604	Battery cell filler	68	5
6522530	605	Battery acid tester	97	1
6522880	607	Terminal opener	144	1
6523180	609	Battery carrying belt	160	1

622

BATTERY TESTER

- For 12 Volt batteries 30 - 180 Ah
- For checking the generator, starter and service voltage
- Automatic test running
- Loading test with CCA-display



Code	No.	Stk	Ein
6524580	622	1360	1



S 1400 ZM



65





SPARK PLUGS

50 - 59

SPARK PLUG SOCKET

- With retention spring
- For use in confined areas, with jointed tools 3/8" or 1/2" square drive or tommy bar Ø 8 mm
- GEDORE vanadium steel 31CrV3, chrome-plated, polished head

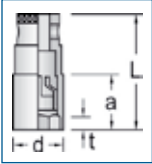

Code	No.	U	Ø mm	Ø _F	□"	L	t	a	d	↕	⊞
6361690	50		20.8	13/16	1/2	63.5	7.0	25.5	27.5	136	10
6362580	52		20.8	13/16	3/8	63.5	7.0	25.5	27.5	148	5
6362740	53		16.0		3/8	63.5	7.0	20.5	21.5	103	5
6363040	54		16.0		1/2	63.5	7.0	20.5	21.5	95	10
6361770	56		18.0		3/8	63.5	7.0	20.5	23.5	138	5
6361930	57		18.0		1/2	63.5	7.0	20.5	23.5	125	5
2004259	59	U	13.0		3/8	63.5	7.0		18.0	74	1

50 MH - 59 MH

SPARK PLUG SOCKET with magnet

- With two magnets
- For use in confined spaces with jointed tools 3/8" or 1/2" square drive or tommy bar Ø 8 mm
- With powerful magnets in the hexagon surface, which hold the spark plug safely on the hexagon
- Wide opening gives space to the spark plug and makes it easier to put on the socket in confined areas
- The ceramic core of the spark plug remains untouched
- GEDORE vanadium steel 31CrV3, chrome-plated, polished head

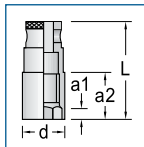

Code	No.	Ø mm	Ø _F	□"	L	a ₁	a ₂	d	↕	⊞
6361420	50 MH	20.8	13/16	1/2	63.5	7.0	30.5	27.5	136	5
6361500	52 MH	20.8	13/16	3/8	63.5	7.0	30.5	27.5	146	5
6363390	53 MH	16.0		3/8	63.5	7.0	30.5	21.5	100	5
6363470	54 MH	16.0		1/2	63.5	7.0	30.5	21.5	94	5
6361850	56 MH	18.0		3/8	63.5	7.0	30.5	23.5	137	5
6362150	57 MH	18.0		1/2	63.5	7.0	30.5	23.5	127	5
6366220	59 MH	13.0		3/8	63.5	7.0	30.5	18.0	74	1



SAFETY NOTES

- For engines with ignition coils integrated in the spark-plug connector (coil-on-plug), use only spark-plug sockets with retainer springs! (Nos. 50 - 59)
- Do not use magnetic spark-plug spanners on coil-on-plug spark plugs!
- This can result in control unit faults!

53 S

SPARK PLUG SOCKET 3/8" with hexagon drive

- Ideal for motorcycles
- For use in confined areas, with jointed tools 3/8" square drive or tommy bar Ø 8 mm or spanners 19 mm
- With retention spring
- GEDORE vanadium steel 31CrV3, chrome-plated, polished head



Code	No.	Ø mm	Ø _F	□"	L	↕	⊞
2237997	53 S	16.0	5/8	3/8	63.5		103

59 GK

GLOW PLUG SOCKET 3/8"

- For diesel engines



Code	No.	Ø mm	□"	L	a	↕	⊞
1897446	59 GK 10x70	10	3/8	70	30	70	1

D 55

SPARK PLUG SOCKET 3/8" UD profile

- With retention spring
- For use with jointed tools 3/8" square drive or tommy bar Ø 8 mm

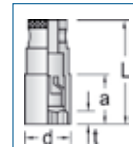

Code	No.	Ø mm	□"	□	L	t	a	d	↕	⊞
1793586	D 55	14	3/8	10	63.5	7.0	22.5	19.2	68	1

S 51 GU

SET OF SPARK PLUG SOCKETS 3/8" 10 pieces

- 4 spark plug sockets with magnets, 1 socket with UD profile
- Reversible ratchet with flexible head and fine tooth mechanism, 3/8" square drive
- 3 extensions, 1 universal joint
- GEDORE vanadium steel 31CrV3
- GEDORIT blue steel case



Code	No.	Contents	↕	⊞
1795554	S 51 GU	52 MH 53 MH 56 MH 59 MH D 55 3093 GU-3 3090-3 -5 -10 3095	2523	1



S 56 U-10 K

SET OF SPARK PLUG SOCKETS 3/8" 8 pieces

- Compact plastic ratchet
- 3 spark plug sockets with magnets, 1 extension
- Feeler gauge, spark-plug brush and magnetic pick-up tool
- With maintenance accessories
- GEDORE vanadium steel 31CrV3, chrome-plated



Code	No.	Contents	🔧	📦
1795570	S 56 U-10 K	52 MH 53 MH 56 MH 3093 U-10 K 3090-7 640-500 648 702 20 M	1958	1

D 48

SPARK PLUG SOCKET WRENCH

- Double ended
- Forged from solid stock
- With fully pivoting sheet metal covered lever
- With sheet clip
- GEDORE vanadium steel 31CrV3, chrome-plated

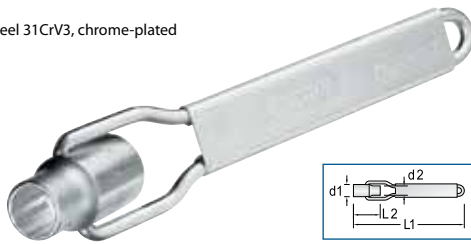

Code	No.	Ø mm	Ø AF	L ₁	L ₂	d ₁	d ₂	🔧	📦
6360100	D 48	16 x 20,8	5/8 x 13/16	232	56	27,5	21,5	233	5

DS 49

SPARK PLUG SOCKET WRENCH

- With rubber holder and offset bores
- Forged and hardened, chrome-plated
- With angled tommy bar No. 49 D Ø 8 mm
- In seamless precision tubing as per DIN 2391-ST 55, chrome-plated



Code	No.	Ø mm	Ø AF	L	d ₁	d ₂	🔧	📦
6361340	DS 49 R	16 x 20,8	5/8 x 13/16	190	24	25	324	1

Code	No.	Description	L	Ø	🔧	📦
6361260	49 R	Spark plug socket wrench 16x20.8 mm	190	270	5	
6360530	49 D	Tommy bar 175 mm, d 8 mm	175	8	73	5

Deviant packing units see article description.

58

SPARK PLUG SOCKET WRENCH

- With retention spring and joint
- Universal wrench, particularly suitable for MERCEDES vehicles
- GEDORE vanadium steel 31CrV3, chrome-plated



Code	No.	Ø mm	Ø AF	L	d	🔧	📦
6363200	58 16	16.0	5/8	500	22.5	647	1
6363120	58 20,8	20.8	13/16	500	27.0	653	1

PR 265 - PR 345

SPARK PLUG SOCKET WRENCH

- With tommy bar 26 D 8 and 1/2" square drive for use with the torque wrenches
- Particularly suitable for Renault and Peugeot

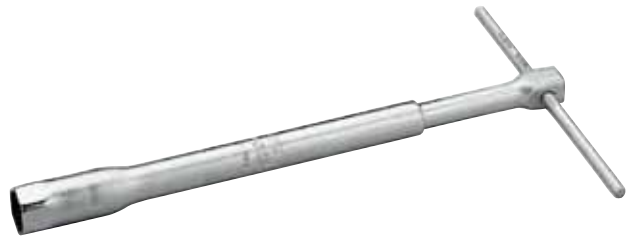

Code	No.	Ø mm	Ø AF	L	d	🔧	📦
6646340	PR 265	16.0	5/8	270	20.2	250	1
6646930	PR 345	20.8	13/16	327	25.5	492	1

647 - 648

SPARK PLUG BRUSH

- With plastic handle and brass wire bristles



Code	No.	Ø mm	L	🔧	📦
6531950	647	180	22	10	
6532090	648	100	9	5	



LIFTERS

121

SUCTION CUP LIFTER with 2 cups

- ✔ With suction mechanism and safety locking
- ✔ In ABS, resistant to oil and acids
- ✔ Fixed suction cups
- ✔ Lifting capacity 60 kg



Code	No.	↳mm↳	∅	↕	📦
6391090	121	325	120	577	1

121-3

SUCTION CUP LIFTER with 3 cups

- ✔ Increased lifting safety with three fixed suction cups
- ✔ Aluminium, enamelled blue
- ✔ Lifting capacity 100 kg



Code	No.	∅	↕	📦
6390790	121-3	120	1403	1

640

MINI MAGNETIC LIFTER

- ✔ Flexible thin shaft for the smallest apertures



Code	No.	↳mm↳	Magnet-∅	∅	↕	📦
6530630	640-120	400	4	120	24	1
1785338	640-270	400	5	270	25	1

640

MAGNETIC LIFTER

- ✔ With flexible shaft and plastic handle
- ✔ Bright nickel-plated



Code	No.	↳mm↳	Magnet-∅	∅	↕	📦
6531010	640-500	460	9	500	95	1
6531280	640-1800	520	15	1800	230	1
6531360	640-3000	520	19	3000	275	1

121 G

SUCTION CUP LIFTER with 2 cups

- ✔ With suction mechanism and safety locking
- ✔ In ABS, resistant to oil and acids
- ✔ Movable suction cups
- ✔ Particularly suitable for curved panes
- ✔ Lifting capacity 45 kg



Code	No.	↳mm↳	∅	↕	📦
6391170	121 G	390	120	642	1

121 G-3

SUCTION CUP LIFTER with 3 cups

- ✔ Three movable suction cups, resistant to oil and acids, in ABS
- ✔ Particularly suitable for curved panes
- ✔ Cups blue colour, handle black aluminium
- ✔ Lifting capacity 100 kg



Code	No.	∅	↕	📦
6390870	121 G-3	120	1345	1

642

MAGNETIC LIFTER with lamp

- ✔ For searching and lifting small metal parts in confined areas
- ✔ With flexible shaft and optical fibres leading through the shaft to the magnet
- ✔ If necessary, the magnet can be removed



Code	No.	↳mm↳	∅	↕	📦
6530470	642	500	350	165	1

642 SP

MAGNETIC LIFTER with lamp, mirror and clip

- ✔ For searching and lifting small metal parts in confined areas
- ✔ If necessary, the magnet can be removed
- ✔ E-642 SP = detachable mirror with clip



Code	No.	↳mm↳	∅	↕	📦
6536750	642 SP	500	350	172	1
1520849	E-642 SP			10	1



**641****CLAW GRIPPER**

- With flexible shaft for grasping small parts
- Also suitable for inserting split pins, dowels, etc. in confined areas
- Max. gripping capacity 14 mm



Code	No.	l mm	Ø	W	H
6531520	641	540	7	103	1

611**UNIVERSAL CANISTER**

- For distilled water
- 2 litres contents
- With plug-in pouring spout
- Polyethylene, black, cap and spout red



Code	No.	L	H	W	litre	W	H
6523340	611	75	220	180	2	226	1

EXHAUST / ENGINE / VARIOUS**4588****CHAIN PIPE CUTTER**

- For cutting pipes at inaccessible places
- Gun-metal finish, handles nickel-plated
- Spare chain E 4588 A



Code	No.	handle length	chain length	Ø mm	Ø inch	W	H
6697840	4588	230	260	25-75	1-3	562	1
5697390	E-4588 A		260			184	1

614**ANTI-FREEZE TESTER**

- For ethylene glycol mixtures
- Practical, reliable apparatus with high measuring accuracy
- Easy-to-read scale with degrees Celsius
- Made from high-quality impact-resistant plastics
- Corrosion-proof
- Suction tube length: 185 mm



Code	No.	W	H
6523770	614	150	1

4589**CHAIN PIPE CUTTER**

- For pipes with Ø 75 mm and wall thickness 2.6 mm
- Also suitable for stainless steel pipes
- Spare chain E 4589 A



Code	No.	length appr.	Ø mm max	W	H
1446940	4589	246	80	909	1
1446959	E-4589 A	315		200	1

8134**INSTALLATION PLIERS**

- For spreading horseshoe pattern circlips of shaft retainers on motors, gearboxes, clutches, etc.
- For VW, AUDI and American vehicles
- GEDORE vanadium steel 31CrV3



Code	No.	l mm	l inch	W	H
6722030	8134-170 C	170	6.3/4	191	1

1600**SPECIAL PIN PUNCH**

- For removal of split pins
- 1600-38** for door hinges, e.g. Opel
- 1600-39** for brake calipers and disc brakes
- 1600-40** with 3 mm guide pin

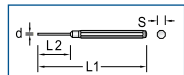

Code	No.	L ₁	L ₂	d	s	W	H
6630180	1600-38	180	90	5	10	72	5
6633950	1600-39	180	90	4	10	67	5
6634090	1600-40	180	85	6	10	77	5

**8385****348**



CAR BODY WORK

269

BODYWORK FILE

- With light-alloy handle and flexible milled file blades
- 269 K complete with 269 F 9
- 269 L without milled file blade



Code	No.	↔mm↔	↔inch↔	⚖	📦
6460080	269 K			1050	1
6460160	269 L			614	1

269 F

FLEXIBLE MILLED FILE BLADES



Code	No.	↔mm↔	Teeth *	⚖	📦
5460030	269 F 7	354	7	249	1
5460110	269 F 9	354	9	289	1
5460380	269 F 12	354	12	303	1

252 - 297

PLANISHING HAND ANVILS

- Made from hardened and tempered steel to EN 10083
- Enamelled, with ground faces

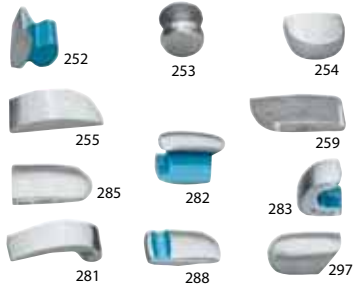

Code	No.	Measurements	⚖	📦
6456990	252	72 x 55 x 63	1206	1
6457020	253	∅ 58.5 x 60	844	1
6457100	254	80 x 60 x 33	1070	1
6457290	255	120 x 58 x 23	942	1
6457610	259	125 x 55 x 25	1028	1
6461720	281	130 x 55 x 36	933	1
6461800	282	100 x 40 x 80 x 70 x 62	1372	1
6461990	283	70 x 54 x 68	1302	1
6462020	285	111 x 68 x 23.5	999	1
6463340	288	104 x 66 x 25	987	1
6464230	297	110 x 51 x 55	1606	1

265

BENDING TOOL

- Made from hardened and tempered steel to EN 10083
- Enamelled, ground faces



Code	No.	↔mm↔	↔inch↔	⚖	📦
6458420	265	430	17	838	1

289 - 291

BODYWORK SPOON

- Made from hardened and tempered steel to EN 10083
- Enamelled, with ground faces

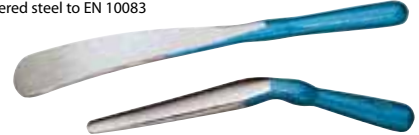

Code	No.	↔mm↔	↔inch↔	⚖	📦
6463420	289	275	11	545	1
6463690	291	390	16	1014	1

292 - 293

BODYWORK LEVER

- GEDORE vanadium steel 31CrV3
- Enamelled, with ground faces



Code	No.	↔mm↔	↔inch↔	⚖	📦
6463770	292	450	16	1888	1
6463850	293	500	19	2186	1

251

FLAT ROUND FACE HAMMER

- With ergonomic ash handle (E-251 E)
- Made from hardened and tempered steel to EN 10083
- Enamelled blue, with ground faces



Code	No.	↔mm↔	↑mm	●mm	●mm	⚖	📦
6456720	251	300	155	40	31	497	1
1808621	E-251 E	300				111	1

261

PLANISHING HAMMER

- With ergonomic ash handle (E-261 E)
- Made from hardened and tempered steel to EN 10083
- Enamelled blue, with ground faces



Code	No.	↔mm↔	↑mm	●mm	⚖	📦
6457960	261	325	160	31	512	1
1440934	E-261 E	325			111	1

260



586



271

LONG REACH HAMMER

- With ergonomic ash handle (E-271 E)
- Made from hardened and tempered steel to EN 10083
- Enamelled blue, with ground faces



Code	No.	↳mm↳	↑mm	●mm	↕mm	📦
6460320	271	330	160	28	673	1
1634844	E-271 E	330			111	1

272 - 273 - 274

SMOOTHING HAMMER

- With ergonomic ash handle (E-251 E, E-274 E)
- Made from hardened and tempered steel to EN 10083
- Enamelled blue, with ground faces
- The K models have one milled cross-hatched face and one square non-milled face



Code	No.	↳mm↳	↑mm	●mm	■mm	↕mm	📦
6460400	272	300	105	32	25	306	1
6460590	272 K	300	105	32	25	322	1
6460670	273	300	100	40	35	403	1
6460750	273 K	300	100	40	35	395	1
6460830	274	320	115	46	40	543	1
6460910	274 K	320	115	46	40	521	1
1808621	E-251 E	300				111	1
1808664	E-274 E	320				90	1

275 - 276

EMBOSSING HAMMER

- With ergonomic ash handle (E-251 E)
- Made from hardened and tempered steel to EN 10083
- Enamelled blue, with ground faces



Code	No.	↳mm↳	↑mm	●mm	↕mm	📦
6461050	275	300	160	40	446	1
6461130	276	300	160	40	446	1
1808621	E-251 E	300			111	1

277

POINT PEIN HAMMER

- With ergonomic ash handle (E-251 E)
- Made from hardened and tempered steel to EN 10083
- Enamelled blue, with ground faces



Code	No.	↳mm↳	↑mm	●mm	↕mm	📦
6461210	277	300	137	37	331	1
1808621	E-251 E	300			111	1

278

PLANISHING / GROOVING HAMMER

- With ergonomic ash handle (E-251 E)
- Made from hardened and tempered steel to EN 10083
- Enamelled blue, with ground faces



Code	No.	↳mm↳	↑mm	●mm	↕mm	📦
6461480	278	300	160	40	406	1
1808621	E-251 E	300			111	1

279

STEEL / RUBBER HAMMER

- With ergonomic ash handle (E-279 E)
- Made from hardened and tempered steel to EN 10083
- Enamelled blue, with ground faces
- Spare rubber cap (E-279)



Code	No.	↳mm↳	↑mm	●mm	●mm	↕mm	📦
6461560	279	360	138	55	33	1022	1
1492330	E-279			55		40	1
1808710	E-279 E	360				150	1





BODYWORK TOOL SETS



- Professional selection of tools
- Available loose or in a sturdy steel case, powder-coated blue hammer finish

260

BODYWORK TOOL SET 8 pieces

- Workshop selection
- Well-chosen workshop assortment for universal use
- In sheet steel case
- Dimensions: 525 x 206 x 78 mm





Code	No.	Contents		
6457880	260	S 260	7.4	1
6459150	S 260	251 252 253 254 255 281 273 K 226 E-2	6.7	1

280

BODYWORK TOOL SET 12 pieces

- Large workshop assortment
- Good selection of the most common bodywork tools
- In sheet steel case
- Dimensions: 545 x 230 x 110 mm





Code	No.	Contents		
6461640	280	S 280	16.9	1
6462290	S 280	272 K 273 K 225 E-32 277 278 281 282 288 291 292 293 259	11.8	1

300

BODYWORK TOOL SET 8 pieces

- Extremely versatile assortment
- Selection of the most common bodywork tools
- In sheet steel case
- Dimensions: 525 x 206 x 78 mm



Code	No.	Contents		
6462370	300	S 300	9.7	1
6462100	S 300	252 255 261 281 282 291 273 K 248 ST-30	7.2	1





SHEET METAL FORMING TOOLS

8532

OFFSETTING PLIERS WITH PUNCH

- Combination pliers for offsetting sheet metal edges up to 1 mm and for punching sheet metal for spot welding
- The rotating head makes both operations possible using one tool
- Single-handed, low-force operation







Code	No.					
6751130	8532	22	5	325	1258	1

8533

PUNCH PLIERS

- With adjustable stop for punching sheet metal up to 1.5 mm



Code	No.					
6751640	8533	up to 30	5	260	955	1



**EQUIPMENT****905****CREEPER**

- ✔ Comfortable, ergonomically shaped one-piece creeper
- ✔ With practical carrying handle
- ✔ Made from PP (polypropylene) - kind on the skin, resistant to oil, grease and brake fluid
- ✔ Six swivel rollers ensure easy and safe manoeuvrability
- ✔ Fatigue-free working, with head/neck cushion for maximum comfort
- ✔ Bucket moulding gives additional hold and allows maximum freedom of movement
- ✔ Two storage trays (right/left) to keep tools and small parts within easy reach
- ✔ Carrying capacity: 130 kg
- ✔ Temperature range -30° C to +60° C
- ✔ Dimensions: 115 x 1030 x 480 mm



Code	No.		
1823698	905	5.0	1

906**KNEELING BOARD**

- ✔ Made from solid foam, blue/black
- ✔ With indented grip
- ✔ Dimensions: 450 x 210 x 30 mm

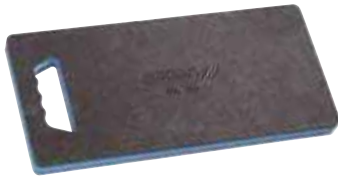

Code	No.		
1942948	906	110	1

907**WING PROTECTOR**

- ✔ Protection from unwanted scratches, dents and dirt
- ✔ Magnetic attachment keeps paintwork safe from damage - also attaches to galvanised steel sheet
- ✔ Rugged, padded imitation leather and reinforced edges provide a perfect, cushioned working area
- ✔ Dimensions: 1100 x 650 mm with wheel cut-out to allow free access



Code	No.		
1942956	907	620	1

K 19**212****BATTERY SCREWDRIVER
PNEUMATIC TOOLS****Please ask for
our detailed
priced leaflet!****711****467**





Spezial-Werkzeugbau-GmbH

When it is a matter of easing and optimizing repairs on vehicles, then across the world you will find KLANN special tools being used again and again.

For over 30 years now we have been developing and manufacturing innovative special tools for all types of vehicles. Our prime aim is to make repairs safer, quicker and thus more reasonable in price.

That is why we undertake intensive developments in our own testing plant so as to react more rapidly to market requirements. We use the most up-to-date technology in production and effect training directly on vehicles in our testing plant.

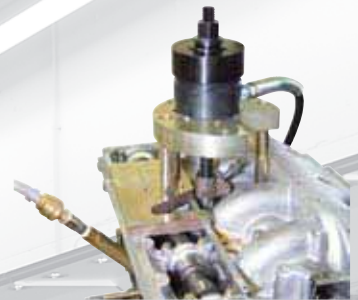
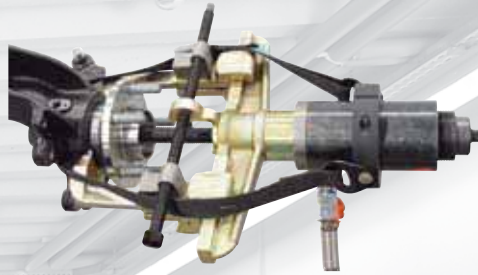

More information?!

You can find more information and the special tools in our main catalogue or on the Internet under:

www.klann-online.de



Quality Special Tools...
long-lasting, reliable and innovative



KIS

Klann Information System

KIS - Klann Information System
Service is the name of the game for us!
Have you heard of our online
Klann Information System?
Here you can transcode OE tool numbers
into KLANN Item Nos.

KLANN-Spezial-Werkzeugbau-GmbH

Breslauer Strasse 41
78166 Donaueschingen
Postfach 1329
78154 Donaueschingen

Tel: +49 (0) 771 / 8 32 23-0
Fax: +49 (0) 771 / 8 32 23-90
info@klann-online.de

www.klann-online.de

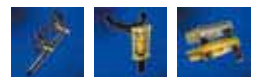

Partner in the **GEDORE** Group

++ SAFETY NOTES

Health is the most important factor when it comes to living a happy life. To ensure that you use our tools safely, please observe the following information.*

* Furthermore, the relevant safety guidelines of various institutions apply, e.g. the guidelines of the trade associations, employers' instructions and the statutory specifications of the respective country.

GENERAL

- ✔ Always wear safety goggles for tasks involving chips or the possibility of parts splintering.
- ✔ Only use the hand tools for their intended purpose.
- ✔ Never modify or tamper with tools. Exceptions: Professional regrinding of chisels, scrapers, cutting tools as well as hammer edges.
- ✔ Never work with damaged tools. Damaged tools must be replaced immediately.
- ✔ Handles must be free of oil and grease.
- ✔ Depending on the task, protect your hands by wearing work gloves.
- ✔ Work on live circuits may only be performed by qualified personnel using suitable VDE tools.
- ✔ Choose a safe surface to ensure stability. Wear safety shoes.
- ✔ Wear the specified ear protection when working in noisy environments.



TOOL TROLLEY

- ✔ Read the operating instructions.
- ✔ Only open one drawer at a time. Opening several drawers at a time increases the tilting moment and the tool trolley can overturn.
- ✔ Always store the heaviest tools in the bottom (heavy-duty) drawer. Storing heavy tools in the upper drawers relocates the centre of gravity upwards which in turn increases the tilting moment. The tool trolley can overturn.
- ✔ Observe the permissible load capacity of individual drawers and the overall load capacity of the tool trolley.
- ✔ Only move the tool trolley when the drawers are closed and locked. Watch out for loose items on the shelf or working area.
- ✔ Always activate the total brake when "parking" the tool trolley. Only then is the tool trolley secured against unintentional movements.
- ✔ Always move the tool trolley facing downwards on slopes.
- ✔ Do not use the tool trolley for climbing.
- ✔ Never store pointed or sharp items loosely in the tool trolley. Scribers can be made safe by sticking them in a cork, for example.



TOOL CHESTS

- ✔ Do not use the tool chest for climbing.
- ✔ Never store pointed or sharp items loosely in the tool chest. Scribers can be made safe by sticking them in a cork, for example.
- ✔ Take care of your back by going down on your hunkers and keeping your upper body straight when lifting out the tool box.



SPANNERS

- ✔ Only use spanner sizes and profiles which fit the bolt or nut head.
- ✔ Do not use spanners as levers or as striking tools.
- ✔ Select the spanner in accordance with the screwed connection. This particularly applies to screwed connections with high torques.
- ✔ Never extend the tool lever arm except when the tools are designed especially for this purpose, e.g. single-ended ring spanners.
- ✔ Never hit a spanner with a hammer except when the tools have an area designed especially for this purpose, e.g. slogging spanners.
- ✔ Always apply the spanner at a right angle to the bolt axis.
- ✔ Always pull the spanner towards you. Never push the spanner away from you. If for design reasons you can only press the spanner away from you, use your open hand to prevent injuring your knuckles.
- ✔ Ring spanners transmit the forces more consistently. Ring spanners are therefore more suitable for large torques.
- ✔ Apply open-ended spanners in such a way that the angle of the jaw is facing in the direction of rotation.
- ✔ If a torque is specified for the screwed connection, use a torque wrench.
- ✔ Never work with damaged spanners. Do not repair damaged spanners but rather replace them without delay.

ALWAYS STORE THE HEAVIEST TOOLS IN THE BOTTOM (HEAVY-DUTY) DRAWER.

- ✔ When the bottom drawer is opened, the centre of gravity is relocated to a safe range.
- ✔ Storing heavy tools in the upper drawers relocates the centre of gravity upwards.
- ✔ When the drawer is opened, the centre of gravity is relocated to a critical range.
- ✔ This makes the tool trolley very susceptible to lateral forces. If the trolley is exposed to lateral forces such as impact, it can overturn.
- ✔ Always observe the load capacity for each drawer to ensure that you always stay in the safe range.

S 1 = tool trolley centre of gravity when the drawer is closed
 S 2 = tool trolley centre of gravity when the drawer is opened
 red = critical range- danger of overturning





++ SAFETY NOTES



SCREWDRIVERS

- Choose the screwdriver which is suitable for the respective bolt head profile.
- Place the workpiece on a ledge or clamp it. This helps to avoid injuries incurred by sliding blades.
- Avoid cuts by directing the requisite pressure for releasing or tightening the bolt head away from your body.
- Wear protective gloves when working with screwdrivers.
- If the screwdriver is too long, do not under any circumstances shorten the blade or handle. Choose a shorter screwdriver.
- Do not use the screwdriver as a caulking or crushing tool.
- Light hammer impact may only be applied for loosening screws using suitable screwdrivers with striking cap or continuous blade.
- If the bolt fails to loosen, use the GEDORE impact driver set no. K 1900-013 to release the bolt without destroying it.
- Insulated and tested screwdrivers must be used when working on electrical systems.



PNEUMATIC TOOLS

- Read the operating instructions.
- Wear safety goggles and ear protection. Wear a dust mask as well when carrying out grinding work.
- Always disconnect the power supply before changing tools.
- Only work with original protective devices.
- Ensure that the voltage or pressure in the line complies with the information provided on the type plate.
- Only use tools which are suitable for impact sockets.
- Observe the permissible diameters and torques for accessories.
- Be aware of your environment. Do not endanger any other persons, e.g. by flying sparks.



RATCHETS, TOOLS AND SOCKETS

- Ratchets are suitable for swift releasing and tightening.
- Avoid jerky movements with the ratchet, e.g. caused by hammer impact.
- The square drive and the tool and socket square drive must be of the same size.
- Select the drive size in accordance with the screwed connection. This particularly applies to screwed connections with high torques.
- Ensure that the ball engages properly in the ball catch.
- Always pull the tool towards you. Never push the tool away from you. If for design reasons you can only press the tool away from you, use your open hand to prevent injuring your knuckles.
- Only use suitable sockets and connections for the impact driver. Use a safety pin and ring to secure the connection between the socket, extension and machine.
- When using reducers, the smaller drive's torque always applies.
- Do not use ratchets as levers or as striking tools.



VDE TOOLS

- Work on electrically live equipment may only be carried out by trained electricians.
- Only tools and safety equipment marked with the double triangle or bell 1000 V symbol (refer to BGV A3) may be used.
- Before commencing any work, check the insulation for damage.
- Damaged tools must not be used.
- The regulations of the employers' liability insurance associations and power supply companies must be complied with.
- GEDORE VDE tools are approved for work on live circuits at voltages up to 1000 V AC and 1500 V DC.
- Tools must not be combined unless they are designed to be securely joined together.



SAFETY NOTES

- Read the operating instructions!
- Use only original spare parts and accessories for your GEDORE puller. Never use worn, modified or defective spare parts or accessories.
- Wear goggles and protective clothing when working. For added safety, use the GEDORE safety cover 5.10!
- Before pulling, ensure that the legs are in contact with the part to be pulled and are firmly tightened so that the spindle operates centrally along the axis of the puller.
- Attention! When using a puller, forces of up to several tons are generated! Take care to ensure that the puller is correctly positioned and is vertical to the component being pulled.
- Do not use electric or pneumatic power or percussion drivers.

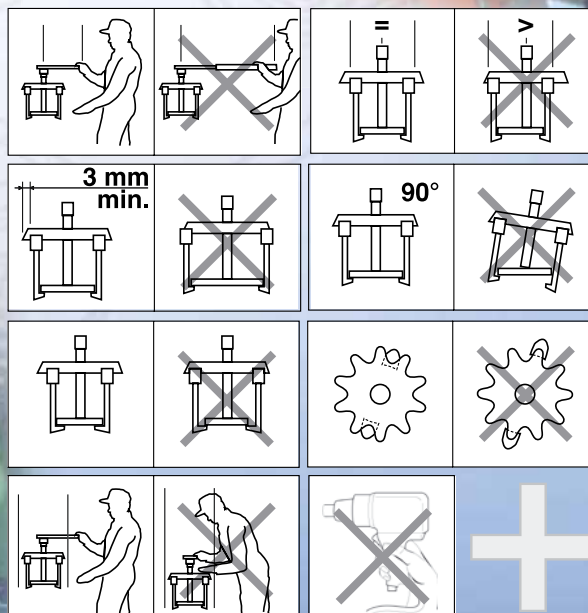

++ SAFETY NOTES



SCREW CLAMPS

- Screw clamps are only suitable for temporarily securing the workpieces.
- Observe the clamping range.
- The clamped connection must not be exposed to any vibrations or impact. Otherwise, there is a risk of the connection releasing unintentionally.
- Do not use screw clamps as a substitute for a handle.
- Never use screw clamps for securing railings, work platforms or scaffolding.



PIPE BENDING SYSTEMS

- Read the operating instructions.
- Never use defective or worn pipe bending systems. Replace defective or worn parts with original parts.
- Use suitable systems and tools for bending.
- Wear safety goggles, safety shoes and protective clothing.
- Ensure stability of the pipe bending system during the bending process.



TORQUE TOOLS

- Read the operating instructions.
- Only use correctly calibrated torque wrenches.
- Treat torque wrenches as measuring equipment. Store torque wrenches carefully.
- Only use torque wrenches within the permissible torque range.
- Stop tightening the bolt immediately once you feel and hear the "click" signal.
- Apply the torque wrench at a right angle to the screwed connection.
- Only use original end fittings or accessories which fit the respective torque wrench.
- Where possible, do not use any reducers.
- Never loosen bolts using a torque wrench.
- Never use the torque wrench as a hammer.
- Slacken the torque wrench after completing work.
- Never use defective or worn accessory parts. Replace defective or worn parts with original parts.
- Only use one hand on the handle of the torque wrench; two-handed operation is only possible using DREMOMETER A - F.



CUTTING TOOLS

- Always set cutting tools down on a clearly visible place. Handles should always point towards you.
- Sharpen your cutting tools regularly. Blunt cutting tools represent a greater risk of injury than sharp ones. Blunt cutting tools require more force to be applied.
- Store cutting tools separately. This protects the blades and your fingers.
- Set shears down with their tips closed. This protects the blades and your fingers.



SAFETY NOTES

- For engines with ignition coils integrated in the spark-plug connector (coil-on-plug), use only spark-plug sockets with retainer springs! (Nos. 50 - 59)
- Do not use magnetic spark-plug spanners on coil-on-plug spark plugs!
- This can result in control unit faults!



SAFETY NOTES FOR STRIKING TOOLS

Chisels

- Wear safety glasses and safety gloves!
- Before starting work, check that the chisel blade is sharp and the striking end is burr-free! The blades must be properly wet-sharpened!
- Select the appropriate type and size of chisel for the work to be carried out!
- Hold the chisel with a firm grip!
- When working, keep your eyes on the chisel tip!
- Wherever possible, use a chisel with hand guard.
- Never use chisels on workpieces harder than 40 HRC!
- Set safety guards in place to prevent splinters and chips posing a hazard for other people!

Centre punches, drifts and mortise chisels

- These tools are subject to the same safety rules as chisels.





++ SAFETY NOTES



WORK GLOVES

- Read the operating instructions.
- Ensure that your work gloves are suitable for the respective task to be performed. Examine your work gloves for damage before use. Damaged work gloves must be replaced.
- Only work using work gloves which fit your hands perfectly.
- Store your work gloves in a clean and dry place.



EAR PROTECTION

- Read the operating instructions.
- Ensure that your ear protection is suitable for the respective task to be performed.
- Examine your ear protection for damage before use. Ear protection displaying damage must be replaced.
- Wear ear protection for the entire duration of your stay in noisy areas.
- Store your ear protection in a clean and dry place.
- Avoid impact against the earpieces. Otherwise, this can lead to a noise level which is harmful for your ears.



SAFETY GOGGLES

- Read the operating instructions.
- Ensure that your safety goggles are suitable for the respective task to be performed.
- Examine your safety goggles for damage before use. Damaged safety goggles must be replaced.
- Store safety goggles in dry areas. Use the black plastic bag provided for this purpose. This will help you to avoid scratches on the lenses.
- Clean the lenses regularly under running water, not when dry.
- Do not wear safety goggles on top of standard spectacles. Mechanical effects can be transferred which may be dangerous.



PLIERS

- Wear protective goggles when working with pliers! Ejected bits of wire and circlips not correctly positioned in the tip of the pliers pose a risk to your eyes!
- Check on the jaws for wear and tear! Worn jaws result in slipping and thus in accidents.
- The joint of the pliers is not to have any noticeable play! Exceptions are the sliding joints.
- When cutting wire, choose pliers that match the wire diameter and wire hardness!
- Never use pliers as hammers!
- Only insulated and tested pliers are to be used when working on electrical equipment!
- Grip wrenches are only for briefly fixing workpieces!



SAFETY NOTES FOR HAMMERS

- Wear safety glasses and safety gloves!
- Use the hammer only for its intended purpose!
- Never misuse the hammer as a lever!
- Before starting work, check that the hammer head is securely attached to the shaft!
- Select the appropriate type and size of hammer for the work to be carried out!
- Never hit two hammers together!
- Never use steel hammers on workpieces harder than 46 HRC! Use suitable plastic-faced hammers for this! In case of doubt, the healthier choice is a suitable plastic-faced hammer.
- Avoid bouncing blows!
- Use only the work faces of the hammer! Blows with the side face damage the non-hardened hammer eye. This can loosen the grip of the shaft in the hammer head.
- If a burr forms on the pein or face of the hammer head, this must be immediately removed. Failure to do this can pose the risk of splintering when the hammer is in use.
- Grip the hammer shaft as far away from the hammer head as possible! This improves the impact effect and avoids vibrations.
- Do not store hammers with wooden shafts in warm, dry environments! Wood is a natural product. Dry, warm storage conditions cause the shaft to lose moisture and shrink, so that the hammer shaft is no longer a tight fit in the hammer head. Opposite storage conditions also have a negative effect on the wooden shaft. Do not store the wooden shaft in too damp conditions! Too much moisture causes the wooden shaft to swell up and destroys the wooden fibres. This can result in the wooden shaft snapping behind the eye area.
- Use only approved hammers for work in explosion-hazard areas!
- Use only suitable GEDORE replacement shafts and wedges.



++ TIGHTENING / TEST TORQUE

Suggested bolt tightening torque in N-m (Newton metres)							Wrench/spanner test torques in accordance with DIN ISO 1711-1 (minimum guaranteed values) N-m													
These torque levels are guideline values for metric standard threads in accordance with DIN ISO 261 and head sizes in accordance with DIN EN ISO 4762, DIN EN ISO 4032, DIN EN ISO 4014, and DIN 931-2, 6912, 7984 und 7990. These produce a 90% utilization of the bolt yield strength. The calculations are based on a friction coefficient of 0.14 (new bolt) without any after treatment, non-lubricated). Please note: in extreme cases, e.g. for bolts lubricated with MoS_2 compound and with cadmium-plated connecting elements on both sides, the tightening torque should be reduced by around 20%.							No. 2, 2A, 2B		No. 4		No. 6, No. 1B, 308, 7		No. 25		No. 26 R No. 626		No. 35 A No. 35 B No. 3112		No. 894 No. 895	
							Tightening values for quality grade as per DIN 267							mm						
	4.6	5.6	6.9	8.8	10.9	12.9	mm													
M 2	0,123	0,162	0,314	0,373	0,520	0,628	4			1,90										
M 2,2	0,196	0,265	0,510	0,598	0,843	1,010	4,5*			2,64										
M 2,5	0,284	0,373	0,726	0,863	1,206	1,451	5	11,5		3,55										
M 3	0,441	0,588	1,128	1,344	1,883	2,256	5,5	14,4		4,64		14,4				2,32				
M 3,5	0,677	0,902	1,736	2,060	2,893	3,481	6*	17,6	7,4	5,92		17,6				2,96				
M 4	1,000	1,344	2,599	3,040	4,315	5,148	7	25,2	11,4	9,12		25,2				4,56				
M 5	1,916	2,648	5,099	6,031	8,483	10,200	8 9*	34,5 45,4	16,6 23	13,3 18,4		34,5 45,4	34,5 45,4	6,65 9,20						
M 6	3,432	4,511	8,728	10,300	14,710	17,652	10	58,1	31	24,8	58,1	58,1	58,1	12,4						
M 7	5,590	7,453	14,220	17,162	24,517	28,439	11 12*	72,7 89,1	40,4 51,5	32,3 41,2	72,7 89,1	72,7 89,1	72,7 89,1	16,1 20,6						
M 8	8,238	10,787	21,575	25,497	35,304	42,168	13 14*	107 128	64,5 79,4	51,6 63,5	107 128	107 128	107 128	25,8 31,7						
M 10	16,67	21,575	42,168	50,014	70,608	85,317	15 16 17*	150 175 201	96,2 115 134	77,0 92,3 107	150 175 201	150 175 201	150 175 201	38,5 46,1 53,5						
M 12	28,44	38,246	73,550	87,279	122,60	147,10	18 19* 20*	230 261 294	160 186 215	128 149 172	230 261 294	230 261 294	230 261 294	64,0 74,5 86,0						
M 14	45,11	60,801	116,70	138,30	194,20	235,40	21 22* 23*	330 368 408	247 281 319	198 225 255	330 368 408	330 368 408	330 368 408	99,0 112 127						
M 16	69,63	93,163	178,5	210,80	299,10	357,90	24 25* 26*	451 496 544	359 402 449	287 322 359	451 496 544	451 496 544	451 496 544	143 161 179						
M 18	95,12	127,50	245,20	289,3	411,90	490,30	27 28*	594 647	499 552	399 442	594 647	594 647	594 647	199 221						
M 20	135,3	180,45	384,10	411,90	578,60	696,30	30	760	670	536	760	760	760	268						
M 22	182,4	245,16	470,70	559,00	784,50	941,40	32* 34	884 1019	804 951	643 761	884 1019	884 1019	884 1019	321 381						
M 24	230,5	308,91	598,20	711,00	1000	1196	36	1165	1117	894	1165	1165	1165	447						
M 27	343,2	460,90	887,50	1049	1481	1775	41	1579	1442	1154	1579	1579	1579	577						
M 30	465,8	622,72	1206	1422	2010	2403	46	2067	1816	1453	2067	2067	2067	726						
M 33	632,5	848,30	1628	1932	2716	3266	50	2512	2145	1716	2512	2512	2512	858						
M 36	814,0	1089	2099	2481	3491	4197	55	3140		2077	3140	3140	3140	1038						
M 39	1059	1412	2716	3226	4531	5443	60	3849		2471	3849		3849	1235						
M 42	1304	1746	3364	3991	5609	6727	65	4021		2900	4021		4021	1422						
M 45	1638	2177	4207	4992	7012	8414	70	4658		3364	4658		4658	1618						
M 48	1981	2638	5080	6021	8473	10150	75	5394		3862			5394	1765						
M 52	2540	3393	6541	7747	10885	13092	80	6178		4394			6178	1912						
M 56	3168	4227	8149	9650	13582	16279	85	6963					6963	2059						
M 60	3932	5247	10101	11964	16867	20202	90	7845					7845	-						
M 64	4737	6306	12160	14416	20300	24320	95	8336					8336	-						

* These sizes are not included in DIN ISO 272

Note:

In reference to the "spanner test torque as per DIN ISO 1711-1" column, we explicitly point out that these are minimum guarantee values. Bolts from M39 in quality grades 4.6, 5.6, 6.9, 8.8, 10.9 and 12.9 are not standardised.





++ TIGHTENING / TEST TORQUE



Wrench/spanner test torques in accordance with DIN ISO 1711-1 (minimum guaranteed values) N-m						Test torques for tightening tools for hexagon socket head screws									
M	mm	With internal square as per DIN 3120					DIN EN ISO 4762	No. 42T, DT42 No. 42, 42EL	No. IN 34	With hexagon head as per DIN 7422					
		6,3	10	12,5	20	25				6,3	10	12,5	20	25	
		No. 20 No. D 20	No. 30 No. D 30	No. 19 No. D 19	No. 32 No. D 32	No. D 21				No. IN 20	No. IN30	No. IN 19	No. IN 32	No. IN 21	
		1/4"	3/8"	1/2"	3/4"	1"									
M 2	4	10,4					1,5	0,82							
M 2,2	4,5*	12,6					2	1,9							
M 2,5	5	15,1													
M 3	5,5	17,8					2,5	3,8							
M 3,5	6*	20,6	23,2												
M 4	7	26,8	33,2				3	6,6	6,6	6,6					
M 5	8	33,6	45,5	94,1			4	16	16	16	16	16			
	9*	41,1	59,9	119,2											
M 6	10	49,1	76,7	147			5	30	30	30	30	30			
M 7	11	57,8	96	178											
	12*	67,0	118	212											
M 8	13	68,6	141	249			6	52	52	52	52	52			
	14*	68,6	169	288			7	80			80	80			
M 10	15		198	331			8	120	120	120	120	120			
	16		225	377											
	17*		225	425			9	165			165				
M 12	18		225	477			10	220	220		220	220			
	19*		225	531											
	20*		225	569			12	370	370		370				
M 14	21		225	569	569										
	22*		225	569	569										
	23*			569	569										
M 16	24			569	569		14	590	590		590	590			
	25*			569	583										
	26*			569	624										
M 18	27			569	665										
	28*			569	707										
M 20	30			569	795		17	980	980		1000	1000	1000		
M 22	32*			569	888										
	34			569	984										
M 24	36				1084	1677	19	1360	1360		1400	1400	1400		
M 27	41				1353	1910									
M 30	46				1569	2143	22	2110				2100	2100		
M 33	50				1569	2329	24	2750							
M 36	55				1569	2562	27	3910							2700
M 39	60				1569	2795	30	4000							
M 42	65					2795	32	4000							
M 45	70					2795									
M 48	75					2795	36	4000							
M 52	80					2795									
M 56	85														
M 60	90														
M 64	95														

The matching test torques are derived from the theoretical load capability of the connecting square drive.

Note:

Hand tightening sockets are unsuited to use with impact drivers. Inappropriate use poses an accident risk. Power driver sockets can be found on page 211.



HEAD WIDTHS AND THREAD DIAMETERS

mm				Nominal size		Thread diameter Ø		Nominal size	
	Metric as per DIN ISO 272	Metric for high-tensile bolted structural joints as per EN 14399-4	"AF"	Inch	mm	Whitw.	BS 916 1083	Inch	mm
2,5 3 3,2	1 1,4 and 1,2 1,6								
4 4,5 5	2 2,3 2,5		5/32 3/16	0,1562 0,1875	3,97 4,76	8 BA 7 BA 6 BA		0,152 0,172 0,193	3,86 4,37 4,90
5,5 6	3 3,5		7/32 1/4	0,2187 0,2500	5,56 6,35	5 BA 4 BA 1/16 W		0,220 0,248 0,256	5,59 6,30 6,90
7 7+8	4 5		9/32 5/16	0,2812 0,3125	7,14 7,94	3 BA 3/32 W 2 BA		0,282 0,297 0,324	7,16 7,54 8,23
9 8+10	5 old 6		11/32 3/8 13/32	0,3438 0,3750 0,4062	8,73 9,52 10,32	1/8 W 1 BA 0 BA	(3/16) (7/32)	0,340 0,365 0,413	8,64 9,27 10,49
11 12 10+13	7 8		7/16 1/2	0,4375 0,5000	11,11 12,70	3/16 W 1/4 W	1/4 5/16	0,445 0,525	11,30 13,34
14* 15 16	8 old 10 autom. 10		9/16 19/32 5/8	0,5625 0,5938 0,6250	14,29 15,08 15,88	5/16 W	3/8	0,600	15,24
13+15+17 18 15+18+19	10 12 12		11/16 3/4	0,6875 0,7500	17,46 19,05	3/8 W	7/16	0,710	18,03
20* 18+21 22+24	14 14	12	25/32 13/16 7/8	0,7812 0,8125 0,8750	19,84 20,64 22,22	7/16 W	1/2	0,820	20,83
23* 21+24* 25*+27*	16		15/16 1.	0,9375 1,0000	23,81 25,40	1/2 W	9/16	0,920	23,37
26* 27 27+28*+30	18	16	1.1/16	1,0625	26,99	9/16 W 5/8 W	5/8 (11/16)	1,010 1,100	25,65 27,94
27+30+34 32+36+41	20 22	20	1.1/8 1.3/16 1.1/4	1,1250 1,1875 1,2500	28,58 30,16 31,75	11/16 W	3/4	1,200	30,48
34 36+41	22 24	22	1.5/16 1.3/8 1.7/16	1,3125 1,3750 1,4375	33,34 34,92 36,51	3/4 W 13/16 W	7/8 (15/16)	1,300 1,390	33,02 35,31
38* 41+46	27	24	1.1/2 1.5/8 1.11/16	1,5000 1,6250 1,6875	38,10 41,28 42,86	7/8 W 1. W	1. 1.1/8	1,480 1,670	37,59 42,42
46+50	30	27	1.3/4 1.13/16 1.7/8	1,7500 1,8125 1,8750	44,45 46,04 47,62	1.1/8 W	1.1/4	1,860	47,24
50+55 55+60	33 36	30	2. 2.1/16 2.3/16	2,0000 2,0625 2,1875	50,80 52,39 55,56	1.1/4 W	1.3/8	2,050	52,07
60+65	39	36	2.1/4 2.3/8 2.7/16	2,2500 2,3750 2,4375	57,15 60,32 61,91	1.3/8 W 1.1/2 W	1.1/2 1.5/8	2,220 2,410	56,39 61,21
65 70	42 45		2.9/16 2.5/8 2.3/4	2,5625 2,3750 2,7500	65,09 66,68 69,85	1.5/8 W 1.3/4 W	1.3/4 2.	2,580 2,760	65,53 70,10
75	48		2.13/16 2.15/16 3	2,8125 2,9375 3,0000	71,44 74,61 76,20	(1.7/8 W)			76,70
80 85 90	52 56 60		3.1/8 3.3/8 3.1/2	3,1250 3,3750 3,5000	79,38 85,72 88,90		2.1/4 2.1/2	3,150 3,550	80,01 90,17
95 100	64 68		3.3/4 3.7/8	3,7500 3,8750	95,25 98,42		2.3/4	3,890	98,81
105 110 115	72 76 80		4.1/8 4.1/4 4.1/2	4,1250 4,2500 4,5000	104,78 107,95 114,30		3. 3.1/4	4,180 4,530	106,17 115,06
120 125*	85		4.5/8 4.7/8 5.	4,6250 4,8750 5,0000	117,48 123,82 127,00		3.1/2	4,850	123,19
130 135 140*	90 95		5.1/4 5.3/8 5.5/8	5,2500 5,3750 5,6250	133,35 136,52 142,88		3.3/4 4.	5,180 5,550	131,57 140,97
145 150 155	100 105 110		5.3/4 6. 6.1/8	5,7500 6,0000 6,1250	146,05 152,40 155,58		4.1/2	6,380	162,05
160* 165 170	115 120								
175* 180 185	125 130								
200 210	140 150								

* not standardised





Nominal size /s in mm	Tolerance class 1 as per ISO 691 dimensions		Tolerance class 2 ^a as per ISO 691 dimensions	
	min.	max.	min.	max.
2 ≤ s < 3	+0,02	+0,08	+0,02	+0,12
3 ≤ s < 4	+0,02	+0,10	+0,02	+0,14
4 ≤ s < 6	+0,02	+0,12	+0,02	+0,16
6 ≤ s < 10	+0,03	+0,15	+0,03	+0,19
10 ≤ s < 12	+0,04	+0,19	+0,04	+0,24
12 ≤ s < 14	+0,04	+0,24	+0,04	+0,30
14 ≤ s < 17	+0,05	+0,27	+0,05	+0,35
17 ≤ s < 19	+0,05	+0,30	+0,05	+0,40
19 ≤ s < 26	+0,06	+0,36	+0,06	+0,46
26 ≤ s < 33	+0,08	+0,48	+0,08	+0,58
33 ≤ s < 55	+0,10	+0,60	+0,10	+0,70
55 ≤ s < 75	+0,12	+0,72	+0,12	+0,92
75 ≤ s < 105	+0,15	+0,85	+0,15	+1,15
105 ≤ s < 150	+0,20	+1,00	+0,20	+1,40
150 ≤ s < 210	+0,25	+1,25	-	-

^aThis tolerance class applies only to ring spanners or socket wrenches that have not been manufactured by material removal.

Spanner sizes in accordance with this international standard must be marked with:

- a) Spanner head size
- b) Reference to the international standard, i.e. ISO 691
- c) Nominal size s in millimetres
- d) Tolerance class 1 or 2

CONVERSION TABLES

INCH TO DECIMAL-INCHES AND MM

in.	dec.in.	mm	in.	dec.in.	mm
0	0	0	1/2	0.5	12,7000
1/64	0.015625	0,3969	33/64	0.515625	13,0969
1/32	0.03125	0,7938	17/32	0.53125	13,4938
3/64	0.046875	1,1906	35/64	0.546875	13,8906
1/16	0.0625	1,5875	9/16	0.5625	14,2875
5/64	0.078125	1,9844	37/64	0.578125	14,6844
3/32	0.09375	2,3812	19/32	0.59375	15,0812
7/64	0.109375	2,7781	39/64	0.609375	15,4781
1/8	0.125	3,1750	5/8	0.625	15,8750
9/64	0.140625	3,5719	41/64	0.640625	16,2719
5/32	0.15625	3,9688	21/32	0.65625	16,6688
11/64	0.171875	4,3656	43/64	0.671875	17,0656
3/16	0.1875	4,7625	11/16	0.6875	17,4625
13/64	0.203125	5,1594	45/64	0.703125	17,8594
7/32	0.21875	5,5562	23/32	0.71875	18,2562
15/64	0.234375	5,9531	47/64	0.734375	18,6531
1/4	0.25	6,3500	3/4	0.75	19,0500
17/64	0.265625	6,7469	49/64	0.765625	19,4469
9/32	0.28125	7,1438	25/32	0.78125	19,8438
19/64	0.296875	7,5406	51/64	0.796875	20,2406
5/16	0.3125	7,9375	13/16	0.8125	20,6375
21/64	0.328125	8,3344	53/64	0.828125	21,0344
11/32	0.34375	8,7312	27/32	0.84375	21,4312
23/64	0.359375	9,1281	55/64	0.859375	21,8281
3/8	0.375	9,5250	7/8	0.875	22,2250
25/64	0.390625	9,9219	57/64	0.890625	22,6219
13/32	0.40625	10,3188	29/32	0.90625	23,0188
27/64	0.421875	10,7156	59/64	0.921875	23,4156
7/16	0.4375	11,1125	15/16	0.9375	23,8125
29/64	0.453125	11,5094	61/64	0.953125	24,2094
15/32	0.46875	11,9062	31/32	0.96875	24,6062
31/64	0.484375	12,3031	63/64	0.984375	25,0031
			1	1	25,4000



TORQUE CONVERSION TABLES

Torque conversion factors

Units to be	Corresponding unit								
	= mN-m	= cN-m	= N-m	= ozf-in	= lbf-in	= lbf-ft	= gf-cm	= kgf-cm (kp-cm)	= kgf-m (kp-m)
1 mN-m	1	0,1	0,001	0,142	0,009	0,0007	10,2	0,01	0,0001
1 cN-m	10	1	0,01	1,416	0,088	0,007	102	0,102	0,001
1 N-m	1000	100	1	141,6	8,851	0,738	10197	10,2	0,102
1 ozf-in	7,062	0,706	0,007	1	0,0625	0,005	72	0,072	0,0007
1 lbf-in	113	11,3	0,113	16	1	0,083	1152,1	1,152	0,0115
1 lbf-ft	1356	135,6	1,356	192	12	1	13826	13,83	0,138
1 gf-cm	0,098	0,01	0,0001	0,014	0,0009	0,00007	1	0,001	0,00001
1 kgf-cm (kp-cm)	98,07	9,807	0,098	13,89	0,868	0,072	1000	1	0,01
1 kgf-m (kp-m)	9807	980,7	9,807	1389	86,8	7,233	100000	100	1

Application:

Conversion formula:
Units to be converted x factor
= corresponding unit

Example:
Convert of 5 lbf-ft in cN-m

Solution:
5 x 135,6 = 678 cN-m

Conversion from N-m in kgf-m (kp-m)

N-m	1 N-m = 0,102 kgf-m									
	0	1	2	3	4	5	6	7	8	9
0	0,00	0,10	0,20	0,31	0,41	0,51	0,61	0,71	0,82	0,92
10	1,02	1,12	1,22	1,33	1,43	1,53	1,63	1,73	1,84	1,94
20	2,04	2,14	2,24	2,35	2,45	2,55	2,65	2,75	2,86	2,96
30	3,06	3,16	3,26	3,37	3,47	3,57	3,67	3,77	3,87	3,98
40	4,08	4,18	4,28	4,38	4,49	4,59	4,69	4,79	4,89	5,00
50	5,10	5,20	5,30	5,40	5,51	5,61	5,71	5,81	5,91	6,02
60	6,12	6,22	6,32	6,42	6,53	6,63	6,73	6,83	6,93	7,04
70	7,14	7,24	7,34	7,44	7,55	7,65	7,75	7,85	7,95	8,06
80	8,16	8,26	8,36	8,46	8,57	8,67	8,77	8,87	8,97	9,08
90	9,18	9,28	9,38	9,48	9,59	9,69	9,79	9,89	9,99	10,10
100	10,20	10,30	10,40	10,50	10,60	10,71	10,81	10,91	11,01	11,11

Conversion from kgf-m (kp-m) in N-m

kgf-m(kp-m)	1 kgf-m (kp-m) = 9,807 N-m									
	0	1	2	3	4	5	6	7	8	9
0	0,00	9,81	19,61	29,42	39,23	49,03	58,84	68,65	78,45	88,26
10	98,07	107,87	117,68	127,49	137,29	147,10	156,91	166,71	176,52	186,33
20	196,13	205,94	215,75	225,55	235,36	245,17	254,97	264,78	274,59	284,39
30	294,20	304,01	313,81	323,62	333,43	343,23	353,04	362,85	372,65	382,46
40	392,27	402,07	411,88	421,69	431,49	441,30	451,11	460,91	470,72	480,53
50	490,33	500,14	509,95	519,75	529,56	539,37	549,17	558,98	568,79	578,59
60	588,40	598,21	608,01	617,82	627,63	637,43	647,24	657,05	666,85	676,66
70	686,47	696,27	706,08	715,89	725,69	735,50	745,31	755,11	764,92	774,73
80	784,53	794,34	804,15	813,95	823,76	833,57	843,37	853,18	862,99	872,79
90	882,60	892,41	902,21	912,02	921,83	931,63	941,44	951,25	961,05	970,86
100	980,67	990,47	1000,28	1010,08	1019,89	1029,70	1039,50	1049,31	1059,12	1068,92

Conversion from N-m in lbf-ft

N-m	1 N-m = 0,7386 lbf-ft									
	0	1	2	3	4	5	6	7	8	9
0	0,00	0,74	1,48	2,21	2,95	3,69	4,43	5,16	5,90	6,64
10	7,38	8,11	8,85	9,59	10,33	11,06	11,80	12,54	13,28	14,01
20	14,75	15,49	16,23	16,96	17,70	18,44	19,18	19,91	20,65	21,39
30	22,13	22,86	23,60	24,34	25,08	25,81	26,55	27,29	28,03	28,76
40	29,50	30,24	30,98	31,72	32,45	33,19	33,93	34,67	35,40	36,14
50	36,88	37,62	38,35	39,09	39,83	40,57	41,30	42,04	42,77	43,52
60	44,25	44,99	45,73	46,47	47,20	47,94	48,68	49,42	50,15	50,89
70	51,63	52,37	53,10	53,84	54,58	55,32	56,05	56,79	57,53	58,27
80	59,00	59,74	60,48	61,22	61,96	62,69	63,43	64,17	64,91	65,64
90	66,38	67,12	67,86	68,59	69,33	70,07	70,81	71,54	72,28	73,02
100	73,76	74,49	75,23	75,97	76,71	77,44	78,18	78,92	79,66	80,39

Conversion from lbf-ft in N-m

lbf-ft	1 lbf-ft = 1,356 N-m									
	0	1	2	3	4	5	6	7	8	9
0	0,00	1,36	2,71	4,07	5,42	6,78	8,13	9,49	10,85	12,20
10	13,56	14,91	16,27	17,63	18,98	20,34	21,69	23,05	24,40	25,76
20	27,12	28,47	29,83	31,18	32,54	33,90	35,25	36,61	37,96	39,32
30	40,67	42,03	43,39	44,74	46,10	47,45	48,81	50,16	51,52	52,88
40	54,23	55,59	56,94	58,30	59,66	61,01	62,37	63,72	65,08	66,43
50	67,79	69,15	70,50	71,86	73,21	74,57	75,93	77,28	78,64	79,99
60	81,35	82,70	84,06	85,42	86,77	88,13	89,48	90,84	92,20	93,55
70	94,91	96,26	97,62	98,97	100,33	101,69	103,04	104,40	105,75	107,11
80	108,46	109,82	111,18	112,53	113,89	115,24	116,60	117,96	119,31	120,67
90	122,02	123,38	124,73	126,09	127,45	128,80	130,16	131,51	132,87	134,23
100	135,58	136,94	138,29	139,65	141,00	142,36	143,72	145,07	146,43	147,78

Conversion from N-m in lbf-in

N-m	1 N-m = 8,851 lbf-in									
	0	1	2	3	4	5	6	7	8	9
0	0,00	8,85	17,70	26,55	35,40	44,25	53,10	61,96	70,81	79,66
10	88,51	97,36	106,21	115,06	123,91	132,76	141,61	150,46	159,31	168,16
20	177,02	185,87	194,72	203,57	212,42	221,27	230,12	238,97	247,82	256,67
30	265,52	274,37	283,22	292,08	300,93	309,78	318,63	327,48	336,33	345,18
40	354,03	362,88	371,73	380,58	389,43	398,28	407,14	415,99	424,84	433,69
50	442,54	451,39	460,24	469,09	477,94	486,79	495,64	504,49	513,34	522,20
60	531,05	539,90	548,75	557,60	566,45	575,30	584,15	593,00	601,85	610,70
70	619,55	628,40	637,26	646,11	654,96	663,81	672,66	681,51	690,36	699,21
80	708,06	716,91	725,76	734,61	743,46	752,32	761,17	770,02	778,87	787,72
90	796,57	805,42	814,27	823,12	831,97	840,82	849,67	858,52	867,38	876,23
100	885,08	893,93	902,78	911,63	920,48	929,33	938,18	947,03	955,88	964,73

Conversion from lbf-in in N-m

lbf-in	1 lbf-in = 0,113 N-m									
	0	1	2	3	4	5	6	7	8	9
0	0,00	0,11	0,23	0,34	0,45	0,56	0,68	0,79	0,90	1,02
10	1,13	1,24	1,36	1,47	1,58	1,69	1,81	1,92	2,03	2,15
20	2,26	2,37	2,49	2,60	2,71	2,82	2,94	3,05	3,16	3,28
30	3,39	3,50	3,62	3,73	3,84	3,95	4,07	4,18	4,29	4,41
40	4,52	4,63	4,75	4,86	4,97	5,08	5,20	5,31	5,42	5,54
50	5,65	5,76	5,87	5,99	6,10	6,21	6,33	6,44	6,55	6,67
60	6,78	6,89	7,00	7,12	7,23	7,34	7,46	7,57	7,68	7,80
70	7,91	8,02	8,13	8,25	8,36	8,47	8,59	8,70	8,81	8,93
80	9,04	9,15	9,26	9,38	9,49	9,60	9,72	9,83	9,94	10,06
90	10,17	10,28	10,39	10,51	10,62	10,73	10,85	10,96	11,07	11,19
100	11,30	11,41	11,52	11,64	11,75	11,86	11,98	12,09	12,20	12,31





Comparison table of Vickers-Brinell-Rockwell hardness and tensile strength

Important prefix characters

Giga	G	1.000.000.000	= 10 ⁹
Mega	M	1.000.000	= 10 ⁶
Kilo	k	1.000	= 10 ³
Hecto	H	100	= 10 ²
Deca	Da	10	= 10 ¹
Deci	d	0,1	= 10 ⁻¹
Centi	c	0,01	= 10 ⁻²
Milli	m	0,001	= 10 ⁻³
Micro	μ	0,000001	= 10 ⁻⁶
Nano	n	0,000000001	= 10 ⁻⁹

Important SI units with conversions to old but still commonly used units

Length	metre	m		
Masa	kilogramme	kg		
Time	second	s		
Force	newton	N	= kg m/s ²	1 N = 0,102 kp
Torque	newton metre	N·m		9,81 N·m = 1 kp·m
Energy (work)	joule	J	= N·m	
Heat quantity	joule	J		1 J = 0,239 cal
Power	watt	W	= N·m/s	1 kW = 1,36 PS = 860 kcal/h
Pressure	pascal	Pa	= N/m ²	100 000 Pa = 1 bar = 10 mWS
Electrical current	ampere	A		
Temperature	kelvin	K		1 K = 1 °C

Conversion table, mass and weight

1 megagramme (Mg)	= 1.000 kg	= 10.000 hg	= 100.000 dag	= 1.000.000 g
1 ton (to.)	= 1.000 kg			
1 kilogramme (kg)		= 10 hg	= 100 dag	= 1000 g
1 hectogramme (hg)			= 10 dag	= 100 g
1 decagramme (dag)				= 10 g
1 gramme (g)	= 10 dg	= 100 cg	= 1000 mg	
1 decigramme (dg)		= 10 cg	= 100 mg	
1 centigramme (cg)			= 10 mg	
1 miligramme (mg)			= 1 mg	

Conversion table, force and torque

1 newton	= 0,102 kp
1 kilopond (kp)*	= 9,81 N
1 kilopond metre (kp·m)*	= 9,81 N·m

* Statutory unit in the Federal Republic of Germany until 1977

Material properties

	Density g/cm ³	Expansion 1/°C	Melting point °C	Modulus of elasticity N/mm
Aluminium	2,7	0,000024	660,1	72 000
Lead	11,3	0,000029	327,3	16 000
Iron (Steel)	7,86	0,000012	1540	210 000
Gold	19,3	0,000014	1063	79 000
Copper	8,9	0,000017	1083	126 000
Zinc	7,1	0,000026	419	94 000
Glass	2,2-2,9	0,000008	800-1500	68 000
Air	0,0013	0,0036		
Wood		0,5-0,7		10 000
Plastics/synthetic materials:				
PS	1,05	0,00008		3 400
PP	0,9	0,00018		1 200
ABS	1,05	0,00010		2 500

Examples

Example 1:
Expansion of a steel body of 100 mm in length at a temperature of 10° C.
Length y expansion coefficient x °C exp. = 100 mm x 0,000012 x 10 = 0,012 mm = 12 μm

Example 2:
Elastic expansion e = s/E.
A body of 100 mm in length made of ABS is stretched with s = 50 N/mm².
e = 50 N/mm²: 2500 N/mm² = 0.02.
The expansion is: 100 mm x 0.02 = 2 mm.

Example 3:
Two steel plates with a total thickness of 20 mm are pre-stressed by means of a screw connection of s = 50 N/mm²: e = 50: 210000 = 0.00024. The compression in the surrounding area of the screw is 20 mm x 0.00024 = 0,0048 mm = 5 μm.

**The elastic compression induces a continuous pre-tension of the screw connection.
A properly tensed screw connection is selfinhibiting.**

Vickers hardness HV 30	Brinell hardness HB 30	Rockwell hardness HRB	Rockwell hardness HRC	Tensile strength sB N/mm ²
80	80,7	36,4	-	270
85	85	42,4	-	290
90	90	47,4	-	310
95	95	52,0	-	320
100	100	56,4	-	340
105	105	60,0	-	360
110	110	63,4	-	380
115	115	66,4	-	390
120	120	69,4	-	410
125	125	72,0	-	420
130	130	74,4	-	440
135	135	76,4	-	460
140	140	78,4	-	470
145	145	80,4	-	490
150	150	82,2	-	500
155	155	83,8	-	520
160	160	85,4	-	540
165	165	86,8	-	550
170	170	88,2	-	570
175	175	89,6	-	590
180	180	90,8	-	600
185	185	91,8	-	620
190	190	91,5	-	640
195	195	94,0	-	660
200	200	95,0	-	670
205	205	95,8	-	680
210	210	96,6	-	710
215	215	97,4	-	720
220	220	98,2	-	730
225	225	99,0	-	750
230	230	-	19,2	760
235	235	-	20,2	780
240	240	-	21,2	800
245	245	-	22,1	820
250	250	-	23,0	830
255	255	-	23,8	850
260	260	-	24,6	870
265	265	-	25,4	880
270	270	-	26,9	900
275	275	-	27,1	920
280	280	-	27,6	940
285	285	-	28,3	950
290	290	-	29,0	970
295	295	-	29,6	990
300	300	-	30,3	1010
310	310	-	31,5	1040
320	320	-	32,7	1080
330	330	-	33,8	1110
340	340	-	34,9	1140
350	350	-	36,0	1170
360	359	-	37,0	1200
370	368	-	38,0	1230
380	376	-	38,9	1260
390	385	-	39,8	1290
400	392	-	40,7	1320
410	400	-	41,5	1350
420	408	-	42,4	1380
430	415	-	43,2	1410
440	423	-	44,0	1430
450	430	-	44,8	1460
460	-	-	45,6	(1490)
470	-	-	46,3	(1520)
480	-	-	47,0	(1550)
490	-	-	47,7	(1580)
500	-	-	48,3	(1600)
510	-	-	49,1	(1630)
520	-	-	49,7	(1660)
530	-	-	50,4	(1690)
540	-	-	51,0	(1710)
550	-	-	51,6	(1740)
560	-	-	52,2	(1770)
570	-	-	52,8	(1790)
580	-	-	53,3	(1820)
590	-	-	53,9	(1850)
600	-	-	54,4	(1870)
610	-	-	55,0	(1900)
620	-	-	55,5	(1930)
630	-	-	56,0	(1950)
640	-	-	56,5	(1980)
650	-	-	57,0	(2000)
660	-	-	57,5	(2030)
670	-	-	58,0	(2050)
680	-	-	58,5	(2080)
690	-	-	59,0	(2110)
700	-	-	59,5	(2130)
720	-	-	60,4	(2170)
740	-	-	61,2	(2220)
760	-	-	62,0	(2260)
780	-	-	62,8	(2300)
800	-	-	63,6	-
820	-	-	64,3	-
840	-	-	65,0	-
860	-	-	65,7	-
880	-	-	66,3	-
900	-	-	66,9	-
920	-	-	67,5	-
940	-	-	68,0	-



GUIDELINE VALUES FOR THE COEFFICIENT OF FRICTION μ

Screw thread		blackened or Zinc-phosphate			Steel	
		pressed rolled	rolled cut	sharpened	cadmium-plated 6 μ	zinc-plated 6 μ
Steel	ground	0,14	0,10	0,16	0,10	0,10
	sharpened	0,16	0,10	0,16	0,10	0,10
	ground sharpened	0,14		0,10		
	turned sharpened	0,10				
	turned sharpened	0,10		0,10	0,10	0,10
	cadmium-plated				0,14	
	zinc-plated					0,10
	cadmium-plated	0,10		0,10	0,14	
	zinc-plated	0,10		0,10		0,14



CHOOSING THE RIGHT FRICTION VALUE

In order to exactly define the pre-tension force and the tightening torque, it is essential to know the coefficient friction. However, it would seem almost impossible to specify definite values for the coefficients of friction for the large variety of possible surface and lubrication conditions and above all for their variance. Added to this are the variances of the various different tightening methods which also constitute a greater or lesser factor of uncertainty. For this reason, it is only possible to make recommendations on the choice of the coefficient of friction. 80% of the tightening-torque values apply for countersunk head screws on account of the remaining base thickness.

GUIDELINE VALUES FOR THE COEFFICIENT OF FRICTION μ

In order to exactly define the pre-tension force and the tightening torque, it is essential to know the coefficient of friction. However, it would seem almost impossible to specify definite values for the coefficients of friction for the large variety of possible surface and lubrication conditions and above all for their variance.

The following circumstances influence the friction value:

The surfaces and the nature of the materials being screwed, the method of lubrication, the sliding path due to the flexibility and the tightening method, i.e. the number and the speed of the tightening cycles and finally the tightening path - the so-called hard or soft screw case. The sum total of these items represents a greater or lesser factor of uncertainty. Even DIN-equivalent screws can differ considerably in their friction value because of being delivered by different suppliers, depending on the screw lot and depending on their storage and, in particular, on the oiling or greasing performed in the course of installation. Please note that around 80 to 90% of the tightening torque in most tightening procedures is required for overcoming the friction in the screw.

Important remark:

For this reason, it is only possible to give recommendations on the choice of the friction value. We point out explicitly that the following tables only contain guideline values. In all cases, a detailed screw calculation is more reliable than these tables! That applies particularly for parts which are relevant to safety, are subject to official regulations or perform sealing functions. The tables should only be utilised where the manufacturer of the screws or elements being connected has made no specifications on the required tightening torques.





FRICION VALUE μ_{ges} 0,10 AND 0,14

Friction value μ_{ges} 0,10		Shank screws with metric ISO medium threads in accordance with DIN ISO 261											
μ_{ges} 0,10	P mm	4.6		5.6		6.8		8.8		10.9		12.9	
		F_{sp} N	M_A N-m	F_{sp} N	M_A N-m	F_{sp} N	M_A N-m	F_{sp} N	M_A N-m	F_{sp} N	M_A N-m	F_{sp} N	M_A N-m
M 2	0,4	367	0,108	459	0,135	734	0,216	979	0,288	1.376	0,405	1.651	0,486
M 2,5	0,45	610	0,221	763	0,276	1.221	0,441	1.628	0,588	2.289	0,827	2.747	0,993
M 3	0,5	915	0,392	1.144	0,491	1.830	0,785	2.441	1,047	3.432	1,472	4.118	1,766
M 3,5	0,6	1.228	0,617	1.535	0,771	2.456	1,234	3.274	1,645	4.605	2,313	5.526	2,776
M 4	0,7	1.587	0,914	1.983	1,142	3.173	1,827	4.231	2,436	5.950	3,426	7.139	4,111
M 4,5	0,75	2.059	1,325	2.574	1,656	4.118	2,649	5.491	3,532	7.722	4,967	9.266	5,961
M 5	0,8	2.593	1,843	3.242	2,304	5.187	3,686	6.915	4,915	9.725	6,912	11.670	8,294
M 6	1	3.661	3,140	4.576	3,925	7.322	6,280	9.762	8,373	13.728	11,775	16.473	14,130
M 8	1,25	6.713	7,609	8.391	9,511	13.426	15,218	17.901	20,291	25.173	28,534	30.208	34,240
M 10	1,5	10.683	15,06	13.354	18,82	21.366	30,11	28.488	40,15	40.061	56,46	48.073	67,75
M 12	1,75	15.571	26,24	19.463	32,80	31.142	52,48	41.522	69,97	58.390	98,39	70.068	118,07
M 14	2	21.377	41,92	26.721	52,40	42.753	83,83	57.004	111,78	80.162	157,19	96.195	188,62
M 16	2	29.373	64,80	36.717	81,01	58.747	129,61	78.329	172,81	110.150	243,02	132.180	291,62
M 18	2,5	35.742	89,80	44.678	112,25	71.484	179,60	95.312	239,46	134.033	336,75	160.840	404,09
M 20	2,5	45.896	126,57	57.370	158,21	91.792	253,14	122.389	337,52	172.109	474,64	206.531	569,57
M 22	2,5	57.312	172,1	71.640	215,1	114.623	344,2	152.831	459,0	214.919	645,4	257.905	774,5
M 24	3	66.090	218,7	82.612	273,4	132.180	437,4	176.240	583,2	247.837	820,2	297.402	984,2
M 27	3	86.922	319,7	108.653	399,6	173.845	639,3	231.793	852,4	325.959	1.198,7	391.150	1.438,4
M 30	3,5	105.686	434,0	132.107	542,5	211.371	868,0	281.828	1.157,3	396.321	1.627,4	475.585	1.952,9
M 33	3,5	131.646	589,0	164.557	736,3	263.292	1.178,1	351.056	1.570,8	493.672	2.208,9	592.407	2.650,7
M 36	4	154.529	757,7	193.161	947,1	309.057	1.515,4	412.076	2.020,5	579.482	2.841,4	695.379	3.409,6
M 39	4	185.617	978	232.021	1.223	371.233	1.957	494.978	2.609	696.062	3.669	835.275	4.403
M 42	4,5	212.619	1.212	265.774	1.515	425.238	2.424	566.983	3.232	797.321	4.545	956.785	5.454
M 45	4,5	248.834	1.510	311.043	1.888	497.669	3.020	663.559	4.027	933.129	5.663	1.119.755	6.795
M 48	5	279.956	1.819	349.945	2.274	559.912	3.638	746.550	4.850	1.049.836	6.821	1.259.803	8.185
M 52	5	335.711	2.346	419.639	2.932	671.422	4.692	895.229	6.256	1.258.916	8.797	1.510.700	10.557
M 56	5,5	387.206	2.919	484.007	3.649	774.412	5.839	1.032.549	7.785	1.452.022	10.948	1.742.427	13.137
M 60	5,5	452.319	3.632	565.399	4.540	904.639	7.265	1.206.185	9.686	1.696.198	13.621	2.035.438	16.345
M 64	6	511.800	4.392	639.751	5.490	1.023.601	8.784	1.364.801	11.713	1.919.252	16.471	2.303.102	19.765
M 68	6	586.272	5.319	732.840	6.649	1.172.545	10.638	1.563.393	14.184	2.198.521	19.947	2.638.225	23.936

Shank screws with metric ISO fine-pitch thread in accordance with DIN ISO 261													
M 8	1	7.343	8,10	9.179	10,13	14.687	16,20	19.582	21,60	27.537	30,38	33.045	36,45
M 10	1	12.288	16,57	15.360	20,71	24.576	33,14	32.768	44,19	46.080	62,14	55.297	74,57
M 12	1,5	16.522	27,34	20.653	34,17	33.045	54,68	44.060	72,91	61.959	102,52	74.351	123,03
M 14	1,5	23.624	44,89	29.530	56,11	47.249	89,78	62.998	119,70	88.591	168,33	106.309	202,00
M 16	1,5	31.988	68,63	39.984	85,79	63.975	137,26	85.300	183,01	119.953	257,36	143.944	308,83
M 18	1,5	41.612	99,49	52.015	124,36	83.223	198,98	110.965	265,30	156.044	373,08	187.253	447,70
M 20	1,5	52.497	138,4	65.621	173,0	104.993	276,8	139.991	369,1	196.862	519,0	236.235	622,8
M 22	1,5	64.642	186,3	80.803	232,8	129.284	372,6	172.379	496,7	242.408	698,5	290.890	838,3
M 24	1,5	78.048	244,1	97.560	305,1	156.096	488,1	208.129	650,8	292.681	915,2	351.217	1.098,3

Friction value μ_{ges} 0,14		Shank screws with metric ISO medium threads in accordance with DIN ISO 261											
μ_{ges} 0,14	P mm	4.6		5.6		6.8		8.8		10.9		12.9	
		F_{sp} N	M_A N-m	F_{sp} N	M_A N-m	F_{sp} N	M_A N-m	F_{sp} N	M_A N-m	F_{sp} N	M_A N-m	F_{sp} N	M_A N-m
M 2	0,4	338	0,130	422	0,163	675	0,261	901	0,348	1.267	0,489	1.520	0,587
M 2,5	0,45	563	0,269	703	0,336	1.125	0,537	1.500	0,716	2.110	1,007	2.532	1,209
M 3	0,5	845	0,480	1.056	0,600	1.689	0,961	2.253	1,281	3.168	1,801	3.801	2,161
M 3,5	0,6	1.133	0,754	1.416	0,942	2.266	1,507	3.021	2,009	4.248	2,826	5.098	3,391
M 4	0,7	1.463	1,115	1.829	1,393	2.927	2,229	3.902	2,972	5.487	4,180	6.585	5,016
M 4,5	0,75	1.901	1,621	2.376	2,026	3.801	3,242	5.068	4,323	7.127	6,079	8.553	7,295
M 5	0,8	2.395	2,261	2.994	2,827	4.790	4,523	6.387	6,030	8.982	8,480	10.778	10,176
M 6	1	3.379	3,843	4.224	4,803	6.758	7,685	9.011	10,247	12.671	14,410	15.205	17,292
M 8	1,25	6.202	9,349	7.753	11,686	12.404	18,698	16.539	24,931	33.258	35,059	27.909	42,070
M 10	1,5	9.876	18,54	12.345	23,18	19.752	37,09	26.336	49,45	37.034	69,54	44.441	83,44
M 12	1,75	14.400	32,37	18.000	40,46	28.801	64,74	38.401	86,32	54.001	121,38	64.801	145,66
M 14	2	19.775	51,77	24.719	64,71	39.551	103,54	52.734	138,06	74.158	194,14	88.989	232,97
M 16	2	27.221	80,62	34.027	100,77	54.443	161,24	72.591	214,98	102.080	302,32	122.497	362,78
M 18	2,5	33.078	111,09	41.347	138,86	66.155	222,17	88.207	296,23	124.041	416,58	148.850	499,89
M 20	2,5	42.534	157,46	53.167	196,82	85.067	314,91	113.423	419,88	159.501	590,46	191.401	708,55
M 22	2,5	53.175	215,1	66.469	268,9	106.350	430,2	141.800	573,7	199.406	806,7	239.288	968,0
M 24	3	61.248	272,1	76.560	340,1	122.497	544,2	163.329	725,6	229.681	1.020,3	275.617	1.224,4
M 27	3	80.670	399,9	100.837	499,9	161.339	799,9	215.119	1.066,5	302.512	1.499,7	363.014	1.799,7
M 30	3,5	98.027	541,7	122.533	677,2	196.054	1.083,4	261.405	1.444,6	367.600	2.031,5	441.120	2.437,7
M 33	3,5	122.241	738,5	152.801	923,2	244.482	1.477,1	325.976	1.969,4	458.404	2.769,5	550.084	3.323,4
M 36	4	143.413	948,0	179.266	1.185,0	286.826	1.896,0	382.434	2.528,0	537.798	3.555,0	645.358	4.265,9
M 39	4	172.420	1.229	215.525	1.536	344.839	2.457	459.786	3.276	646.574	4.607	775.888	5.529
M 42	4,5	197.407	1.519	246.758	1.899	394.813	3.038	526.417	4.050	740.275	5.696	888.329	6.835
M 45	4,5	231.206	1.898	289.007	2.373	462.412	3.796	616.549	5.062	867.022	7.118	1.040.426	8.541
M 48	5	260.008	2.282	325.010	2.853	520.015	4.565	693.354	6.086	975.029	8.559	1.170.035	10.211
M 52	5	312.056	2.954	390.070	3.692	624.112	5.907	832.149	7.876	1.170.209	11.076	1.404.251	13.292
M 56	5,5	359.843	3.672	449.804	4.591	719.686	7.345	959.581	9.793	1.349.411	13.772	1.619.293	16.526
M 60	5,5	420.651	4.582	525.813	5.728	841.301	9.164	1.121.735	12.219	1.577.440	17.183	1.892.928	20.619
M 64	6	475.860	5.536	594.825	6.920	951.720	11.071	1.268.960	14.762	1.784.476	20.759	2.141.371	24.911
M 68	6	545.427	6.720	681.784	8.400	1.090.855	13.440	1.454.473	17.919	2.045.353	25.199	2.454.423	30.239

Shank screws with metric ISO fine-pitch thread in accordance with DIN ISO 261													
M 8	1	6.805	10,08	8.507	12,60	13.611	20,15	18.148	26,87	25.520	37,79	30.624	45,35
M 10	1	11.418	20,83	14.272	26,04	22.835	41,66	30.447	55,55	42.816	78,11	51.379	93,73
M 12	1,5	15.312	34,01	19.140	42,51	30.624	68,02	40.832	90,69	57.420	127,54	68.904	153,05
M 14	1,5	21.934	56,25	27.418	70,32	43.868	112,51	58.491	150,01	82.253	210,96	98.703	253,15
M 16	1,5	29.741	86,50	37.177	108,12	59.483	172,99	79.310	230,66	111.530	324,36	133.836	389,23
M 18	1,5	38.733	125,95	48.417	157,44	77.467	251,91	103.289	335,88	145.250	472,		

FRICION VALUE μ_{GES} 0,14



Friction value μ_{ges} 0,14

Shank screws with metric ISO medium threads in accordance with DIN ISO 261

μ_{ges} 0,14	P mm	4.6		5.6		6.8		8.8		10.9		12.9	
		F_{sp} N	M_A N-m	F_{sp} N	M_A N-m	F_{sp} N	M_A N-m	F_{sp} N	M_A N-m	F_{sp} N	M_A N-m	F_{sp} N	M_A N-m
M 2	0,4	324	0,140	405	0,175	647	0,280	863	0,373	1.214	0,525	1.456	0,630
M 2,5	0,45	539	0,289	674	0,361	1.079	0,578	1.439	0,770	2.023	1,083	2.428	1,300
M 3	0,5	810	0,517	1.013	0,647	1.620	1,035	2.161	1,380	3.038	1,940	3.646	2,328
M 3,5	0,6	1.086	0,811	1.358	1,014	2.173	1,622	2.897	2,163	4.074	3,042	4.889	3,650
M 4	0,7	1.403	1,199	1.754	1,499	2.806	2,398	3.742	3,198	5.262	4,497	6.314	5,396
M 4,5	0,75	1.823	1,746	2.279	2,182	3.646	3,492	4.861	4,656	6.836	6,547	8.204	7,857
M 5	0,8	2.298	2,438	2.872	3,047	4.596	4,875	6.127	6,500	8.617	9,141	10.340	10,969
M 6	1	3.241	4,139	4.051	5,173	6.482	8,277	8.643	11,036	12.154	15,520	14.584	18,623
M 8	1,25	5.951	10,083	7.438	12,603	11.901	20,165	15.868	26,887	22.315	37,809	26.778	45,371
M 10	1,5	9.477	20,01	11.847	25,02	18.955	40,03	25.273	53,37	35.540	75,05	42.648	90,06
M 12	1,75	13.821	34,96	17.277	43,69	27.642	69,91	36.857	93,22	51.830	131,08	62.195	157,30
M 14	2	18.982	55,93	23.728	69,91	37.964	111,86	50.619	149,15	71.183	209,74	85.419	251,69
M 16	2	26.145	87,30	32.682	109,13	52.291	174,61	69.721	232,81	98.045	327,39	117.654	392,87
M 18	2,5	31.755	120,08	39.694	150,10	63.510	240,15	84.680	320,20	119.081	450,29	142.897	540,34
M 20	2,5	40.852	170,52	51.065	213,14	81.704	341,03	108.939	454,71	153.195	639,43	183.834	767,32
M 22	2,5	51.093	233,3	63.867	291,7	102.187	466,6	136.249	622,2	191.600	875,0	229.921	1.050,0
M 24	3	58.827	294,7	73.534	368,3	117.654	589,3	156.872	785,7	220.601	1.104,9	264.721	1.325,9
M 27	3	77.519	433,9	96.899	542,4	155.038	867,9	206.717	1.157,2	290.696	1.627,2	348.835	1.952,7
M 30	3,5	94.179	587,3	117.724	734,2	188.358	1.174,6	251.144	1.566,2	353.172	2.202,5	423.806	2.642,9
M 33	3,5	117.488	801,9	146.860	1.002,3	234.977	1.603,8	313.302	2.138,3	440.581	3.007,0	528.697	3.608,5
M 36	4	137.811	1.028,6	172.264	1.285,7	275.623	2.057,2	367.497	2.742,9	516.793	3.857,2	620.152	4.628,6
M 39	4	165.738	1.335	207.172	1.668	331.475	2.669	441.967	3.559	621.516	5.005	745.819	6.006
M 42	4,5	189.724	1.649	237.155	2.061	379.448	3.298	505.930	4.397	711.465	6.183	853.758	7.420
M 45	4,5	222.267	2.063	277.834	2.578	444.534	4.125	592.712	5.500	833.501	7.735	1.000.201	9.282
M 48	5	249.916	2.479	312.395	3.099	499.833	4.958	666.444	6.610	937.186	9.296	1.124.624	11.155
M 52	5	300.035	3.212	375.043	4.014	600.069	6.423	800.093	8.564	1.125.130	12.043	1.350.156	14.452
M 56	5,5	345.954	3.992	432.442	4.990	691.908	7.984	922.544	10.645	1.297.327	14.969	1.556.793	17.963
M 60	5,5	404.516	4.985	505.645	6.232	809.031	9.970	1.078.709	13.294	1.516.934	18.695	1.820.321	22.433
M 64	6	457.571	6.021	571.964	7.526	915.142	12.042	1.220.189	16.056	1.715.891	22.579	2.059.069	27.095
M 68	6	524.576	7.315	655.720	9.143	1.049.152	14.629	1.398.869	19.506	1.967.160	27.430	2.360.592	32.916

Shank screws with metric ISO fine-pitch thread in accordance with DIN ISO 261

M 8	1	6.536	10,91	8.170	13,64	13.073	21,83	17.430	29,10	24.511	40,92	29.413	49,11
M 10	1	10.976	22,64	13.720	28,29	21.952	45,27	29.270	60,36	41.161	84,88	49.393	101,86
M 12	1,5	14.707	36,83	18.383	46,04	29.413	73,66	39.218	98,22	55.150	138,12	66.180	165,74
M 14	1,5	21.080	61,07	26.351	76,34	42.161	122,14	56.214	162,86	79.052	229,02	94.862	274,82
M 16	1,5	28.598	94,08	35.748	117,60	57.196	188,16	76.262	250,88	107.243	352,80	128.692	423,35
M 18	1,5	37.260	137,20	46.575	171,50	74.519	274,40	99.359	365,87	139.724	514,51	167.669	617,41
M 20	1,5	47.065	191,8	58.831	239,7	94.130	383,6	125.506	511,4	176.494	719,2	211.792	863,0
M 22	1,5	58.014	259,2	72.517	324,0	116.027	518,4	154.703	691,2	217.551	971,9	261.062	1.166,3
M 24	1,5	70.106	340,7	87.632	425,9	140.212	681,5	186.949	908,6	262.897	1.277,7	315.477	1.533,3

Specifications given without warranty

LEGEND

- μ_{ges} = Average friction value for thread and underhead seat
- P = Pitch of the thread
- F_{sp} = Axial pre-tension force in the screw for 90% utilisation of the screw yield point (determined in accordance with the shape-changing-energy hypothesis)
- M_A = Tightening torque during installation

IMPORTANT REMARKS

Please make sure to read our information relating to the guideline values of the thread friction values on page 600. Taking into consideration the friction values, the above-specified table values only apply for headless screws (expanding screws generally require lower tightening values). The effective friction diameter in the screw underhead seat was defined as 1.3 x external thread diameter. For this reason, it is only possible to use them in the case of normal shank screws, generally hexagon-headed and cylindrical-head screws (e.g. DIN EN ISO 4014, 4017, 4764, DIN 7984). When screws of high strengths (8.8 to 12.9) and tensed parts made of "soft" construction materials are used, a verification of the interfacial pressure under the screw head is strongly recommended.





THE PROPERTIES OF SCREWS AND NUTS ARE DESCRIBED WITH THE AID OF STRENGTH CLASSES.

This is shown in the table below on the basis of 10 strength classes for which the properties such as tensile strength, hardness, yield point, elongation after fracture, etc. are shown.

Section ISO 898-1	Mechanical and physical properties	Strength class											
		3.6	4.6	4.8	5.6	5.8	6.8	8.8 d ≤ 16 mm	8.8 1 3 d > 16 mm 3	9.8 2	10.9	12.9	
5.1	Norm, tensile strength R _m , nominal	N/mm ²	300	400	400	500	500	600	800	800	900	1000	1200
5.2	Norm, tensile strength R _m , min. 4 5	N/mm ²	330	400	420	500	520	600	800	830	900	1040	1220
5.3	Vickers hardness HV F ≥ 98 N	min.	95	120	130	155	160	190	250	255	290	320	385
		max.	220 6	220 6	220 6	220 6	220 6	250	320	335	360	380	435
5.4	Brinell hardness HB F = 30 D ²	min.	90	114	124	147	152	181	238	242	276	304	366
		max.	–	–	209 6	–	–	238	304	318	342	361	414
5.5	Rockwell hardness HR	min.	HRB	52	67	71	79	82	89	–	–	–	–
		min.	HRC	–	–	–	–	–	22	23	28	32	39
		max.	HRB	95,0 6	95,0 6	95,0 6	95,0 6	95,0 6	99,5	–	–	–	–
		max.	HRC	–	–	–	–	–	32	34	37	39	44
5.6	Surface hardness HV 0,3	max.	–	–	–	–	–	–	–	–	7	–	
5.7	Lower yield point R _{el} 8 in N/mm ²	Nominal value	180	240	320	300	400	480	–	–	–	–	–
		min.	190	240	340	300	420	480	–	–	–	–	–
5.8	0.2%-yield strength R _{p0.2} 9 in N/mm ² raised	Nominal value	–	–	–	–	–	–	640	640	720	900	1080
		min.	–	–	–	–	–	–	640	660	720	940	1100
5.9	Wind-up force under test force	S _p /R _{el}	0,94	0,94	0,91	0,93	0,90	0,92	0,91	0,91	0,90	0,88	0,88
		S _p /R _{p0.2} S _p	180	225	310	280	380	440	580	600	650	830	970
5.10	Fracture torque M _b	N·m min.	–	–	–	–	–	–	see ISO 898-7				
5.11	Elongation after fracture A in %	min.	25	22	–	20	–	–	12	12	10	9	8
5.12	Fracture construction Z	% min.	–	–	–	–	–	–	52	52	48	48	44
5.13	Strength under diagonal pull strain 5		The values under diagonal pull strain for whole screws (not pin screws) must not fall below the minimum tensile strengths stated in Section 5.2										
5.14	Notched bar impact KU	J min.	–	–	–	25	–	–	30	30	25	20	15
5.15	Notched impact strength		no fracture										
5.16	Minimum height of the non-decarbonised thread zone E Maximum depth of decarburisation G	mm	–	–	–	–	–	–	1/2 H ₁	1/2 H ₁	1/2 H ₁	2/3 H ₁	3/4 H ₁
		mm	–	–	–	–	–	–	0,015	0,015	0,015	0,015	0,015
5.17	Hardness after tempering		Hardness drop max. 20 HV										
5.18	Surface condition		in accordance with ISO 6157-7 or ISO 6157-3, where applicable										

1 In the case of screws of the strength class 8.8 having a thread diameter $d \leq 16$ mm, an increased danger of scraping exists for nuts if the screw connection is tightened with a force exceeding the test force of the screw. It is recommended to comply with the standard ISO 898-2.

2 The strength class 9.8 only applies for nominal thread diameters ≤ 16 mm.

3 For steel screws, the limit is 12 mm.

4 The minimum tensile strengths apply for screws with nominal lengths $l \geq 2.5 d$. The minimum hardness values apply for screws with nominal length $l < 2.5 d$ and for those products which cannot be tested in a tensile test (e.g. on account of their head shape).

5 For tests on full screws, the fracture forces used to calculate R_m must concur with the properties of the screws at higher temperature.

6 A hardness value at the end of the screw is permitted to be 250 HV, 238 HB or 99.5 HRC at most.

7 The surface hardness on the relevant product must not exceed 30 Vickers points of the measured core hardness if both the surface hardness and the core hardness are determined with HV 0.3. For the strength class 10.9, a surface hardness of 390 HV must not be exceeded.

8 If the lower yield point R_{el} cannot be determined, the 0.2% yield strength R_{p0.2}, lowered, applies. For the strength classes 4.8, 5.8 and 6.8, the values for R_{el} are only specified on a calculation basis - they are not tested.

9 The yield point ratio corresponding to the description of the strength class and the minimum wind-up force on the 0.2% yield strength R_{p0.2}, both apply for machine-processed test pieces. When full screws are tested, these values vary on account of the effects of the manufacturing process and the size factors.

Excerpt from EN ISO 898-1



TIGHTENING TORQUES FOR WHEEL NUTS AND WHEEL SCREWS OF INDUSTRIAL VEHICLES, SERIAL WHEEL RIMS

(in the case of aluminium wheel rims, comply with the manufacturer's specifications!)

Vehicle manufacturer	Thread	Pin centring	Middle centring	Trilex
Bergische axles BPW				
all	M18x1,5	270	320	270-300
	M18x2			
	M20x1,5	350	450	320-350
	M20x2			
	M22x1,5	450-500	600-650	
	M20x2			
7/8"-BSF				
DAF all	M18x1,5		340-400	
	M20x1,5		450-520	
	M22x1,5		700	
Evobus all	M18x1,5	300		300
	M18x2			
	M20x1,5	400		350
	M20x2			
	M22x1,5	450	600	
Iveco all	M18x1,5	380-450	335-410	370-400
	M20x1,5		440-540	
	M22x1,5		580-650*	
			599-732**	
Kässbohrer axles				
all	M18x1,5	270	320	270-300
	M18x2			
	M20x1,5	350	450	320-350
	M20x2			
	M22x1,5	450-500	600-650	
	M20x2			
	7/8"-BSF			
MAN all	M18x1,5	285	390	285
	M18x2			
	M20x1,5	390	475	335
	M20x2			
	M22x1,5	475	575	575
Mercedes Benz all, apart from Unimog	M16x1,5			200
	M18x1,5			300
	M20x1,5			350
	M22x1,5			450
				600
Unimog	M18x1,5	400	450	
	M20x1,5		600	
Renault Trucks all	M22x1,5		450-550	315-385
Sauer axles SAF all	M18x2			270-300
	M20x2			320-350
	M22x1,5			430
	M22x2			430
				600
Scania all	7/8"-11 BSF		600	350
Volvo FL, FLC	M18x1,5		375±65	
	M20x1,5		450±45	
	M22x1,5		600±50	
FS7, FL6, FL7, FL10, FL12, F, N, FH, NL, FM, FE	M20x1,5		525±75*** / 450±50****	360±40
	M22x1,5		200±8Nm + 90±10° *****	
	7/8"-14 UNF		200±8Nm + 90±10° *****	

* = drum brake
 ** = disc brake
 *** = black surface (phosphated)
 **** = grey surface (Dacromet)
 ***** = when checking min. 670 Nm



8561-8563



**240
241**

4550



252





TIGHTENING TORQUES FOR WHEEL NUTS AND WHEEL SCREWS OF CARS AND ESTATE CARS

Cars (in the case of aluminium wheel rims, comply with the manufacturer's specifications!)



Vehicle manufacturer		Tightening torque N-m	Vehicle manufacturer		Tightening torque N-m	Vehicle manufacturer		Tightening torque N-m	
ALFAROMEO	Alfa 33	88-108	ISUZU	Trooper until 1992	80-118	NISSAN	Micra (1992-02)/X-Trail	98-117	
	Alfa 145/146/147/Spider/GTV	83-103		Trooper from 1992	118		Almera (2002-02)/Maxima (2000-02)/Serena (1996-02)	98-118	
	Alfa 155 (V6)	73-90		Campo until 1997	78-98		Terrano II/Patrol GR/Pick-Up	118-147	
	Alfa 156	98		Campo from 1998	82				
	Alfa 164	95-105	JAGUAR	X-Type (2001-02)	68-92	OPEL	Agila	85	
	Alfa 166	86		S-Type	128		Frontera-B (1999-02)	120	
		XJ6		65-85	other models		110		
AUDI	A2/A3/S3/A4/A6/100/A8/S8/TT	120	XJR/XJ12	88-102	PEUGEOT	106/206/Estate	85		
	Audi 80/Coupé/Cabriolet/Audi Audi Quattro	200	XJ8/XJ-S	66-82		306	80		
		110				307/406/605/607	90		
BMW	3 Serie/5 Serie	90-110	KIA	Pride/Mentor/Sephia/Clarus/Carens		88-118	806/Expert	100	
	M5	100		Sedona/Sportage		88-108	Boxer	160-180	
	Z3	100-110		Besta	90-120	PORSCHE	all models	130	
	X5	140	LADA	Samara/Riva	70-78		RENAULT	Twingo/Clio/Megane/Safrane/Kangoo R5	90
	CHRYSLER	Neon (1994-99)/Stratus/Neon (1999-02)/PT Cruiser		109-150	Niva	88-91	ROVER	Clio Sport/Scenix RX4	80
Voyager (1987-90)/Caravan		129	LANCIA	other models	86	Laguna/Espace		100	
Voyager (2001-02)		110-135		Dedra/Kappa	98	Trafic (2000-02)		142	
Jeep Wrangler (1993-96)		102		LAND ROVER	Freelander	115		Master	155
Jeep Wrangler (1996-02)		109-150	Defender		100-120	SAAB		900 (1993-98)	90-110
Jeep Cherokee (1997-01)		115-150	Discovery until 1998		129		9000 (1989-97)	105-125	
Jeep Grand Cherokee (1997-01)		115-150	Discovery from 1998	140	9-3		110		
CITROËN		AX10/AX11/AX14/AX GT/AX GTI/AX Sport/ZK	90	Range Rover from 1994	108	9-5	120		
	Saxo/Xsara	85	LEXUS	all models	103	SEAT	Arosa/Inca	110	
	Xantia/XM	90		LOTUS	Elise (lightweight metal wheel rims)		90	Ibiza/Cordoba	110
	C5	80-100	Elan (lightweight metal wheel rims)		80-88		Toledo (1999-02)/Leon	120	
	C15E	70	Excel (lightweight metal wheel rims)		88		Alhambra	140	
	DAEWOO	Matiz	90-110	Esprit (lightweight metal wheel rims)	100	SKODA	Fabia/Octavia	120	
	Nexia/Lanos/Espero/Nubira	80	MAZDA	121 from 1995	85		SUBARU	all models	78-98
Leganza	100	323 from 1998		90-117	SUZUKI			Alto	70-100
Tacuma	108	626 from 1997		80-115		Swift		80-80	
Musso/Korando/	80-120	Xedos 6 from 1994				Liana/Ignis/Baleono/Wagon			
Cuore/Applause/YRV/Move/Grand Move/Terios	88-118	MX-6 from 1994				R/Super Carry (1999-02)	85		
Charade/Sirion/Hi-Jet	89-118	MVP from 1999		89-117	Jimmy/Grand Vitara	95			
Sportrak	90-120	Xedos 9		88-127	Vitara	80-100			
FIAT	other models	86		MX-5 from 1998	90-117	TOYOTA	Yaris, Corolla, Carina, Avensis, Camry, MR2, Paseo, Celica, Supra, Picnic, Previa, RAV4, 4 Runner	103	
	Stilo/Croma/Coupé/	98		Demio	87-117		VOLKSWAGEN	Landcruiser Colorado/Prado (1996-02)	110
	Ulysee/Scudo	100		Premacy	80-117			Lupo, Caddy, Golf, Polo	110
	Ducato/Talento	160	Tribute	133	Passat (1996-02), Beetle			120	
	Ducato Maxi	180	E-Series	90-120	Sharan (2001-02)	170			
FORD	KA/Mondeo (1996-00)/Scorpio/Puma	85	MERCEDES-BENZ	other models	110	Transporter (1996-02), LT (1996-02)	180		
	Fiesta (1990-93)	70-100		S-Class (1998-02)/M-Class	150	VOLVO	S40/V40 (1998-02), S70/V70 (1997-00), C70	110	
	Fiesta (1994-02)/	85		CL (1999-02)	150		S60 (2002-02), V70 (2000-02), S80	140	
	Focus (1998-02)			V-Class (1995-02)/Vito	175				
	Escort/Estate (1995-00)/Sierra	100		200GE/230GE	190				
	Probe	88-117		Sprinter (1995-02)	180 + 20				
	Cougar	128	MB 100D	140					
	Galaxy (2001-02)	170	508D/510	160-180					
	Maverick (2001-02)	133	814 DA	250					
	Explorer	135	MINI	Mini One/Mini Cooper	90-110				
	Transit 80/100 (1991-00)	75-95							
	Transit 130 (außer 1995)/150	155-180 (175)							
	Transit (2002-02)	200	MITSUBISHI	Colt/Lancer (1996-02)/Galant (1997-02)	98				
HONDA	all models	108-110		Carisma	98-117				
	HYUNDAI	other models		90-110	Eclipse (1996-02)	117-137			
Pony (bis 90)/Stellar/		70-80		3000 GT (1993-01)/L200	120-140				
S Coupé (90-92)		88-108		Space Star	98-117				
H1/H200		120-140		Space Runner (1998-02)	98				
				Space Wagon (1998-02)	98				
		Shogun Pinin		98					
		Shogun Pajero	100-120						

10 N-m ≈ 1 kp-m

Specifications given without warranty.

Mounting wheels

Using a torque wrench, lighten the wheel nuts and screws uniformly over the cross up to the specified torque. Without fail, check the torque following a travelling distance of approx. 50 km after the wheel is mounted and at regular intervals. If a wheel-specific general operating licence is the case, it must comply with the tightening torque specified here.

Use regulation-compliant wheel attachment elements

(Do not mix up spherical and conical, different lengths, parts for steel and lightweight-metal wheels etc.! Ensure sound strength quality!) Replace difficult-to-manipulate or corroded screws and nuts! Exercise caution with lubricants!



Specifications given without warranty.

Article Index

Article	Page
A	
Accessories	562 - 565
Accessories for socket wrenches 1/2" in 1/3 tool module	88
Adaptor	226
Adaptor for 7 R / 7 UR	109
Adaptor pieces for screwdriver bits	225, 229
Adaptor set 1/4"	157
Additional drawer	31
Adjustable breaking wrench ATB with scale	261
Adjustable spanner open end	113
Adjustable wrench	491, 504
Air hydraulic pump for heavy-duty pullers	414
Aligning tools for treadles	470
All-steel screw clamp	479
Aluminium prybar	459
Aluminium reversible ratchet 1/2"	179
Aluminium reversible ratchet 3/8"	164
Angled combination pliers	313
Angle reamer	537
Anti-freeze tester	583
Anti-slip mat Products sold by the metre	41
Anvil horn	446
Arc punch	539
Automatic centre punch with tip	455
Automobile workshop set Add-on system	406

B

Balance weight pliers	574
Ball bearing extractor	392, 393
Ball bearing extractor set	393
Ball joint puller	401
Base plate	43
Basic tool assortment in tool case	70
Basic tool set 1/4" for motorbikes	159
Basic tool set	58
Basin pliers	534
Basin wrench	534
Battery servicing tools	579
Battery-terminal puller 2-3 arm pattern	382
Battery tester	579
Bending bar	459
Bending former	546, 548 - 550
Bending former MSR	561
Bending frame	558
Bending tool	459
Bending tools	547, 551, 553 - 555, 562 - 565
Bent nose telephone pliers NC	495
Bicycle compact tool	471
Bit adaptor	220
Bit adaptor 1/4"	225
Bit extension	220
Bit extension 1/4"	226
Bit extension 5/16"	229
Bit holder	227
Bit ratchet	220
Bit reversible ratchet	226, 229
Bit screwdriver	220, 227, 229
Bit screwdriver 1/4"	226
Bit set	224, 225, 229
Blacksmith's tongs	447
Bodywork file	584

Article Index

Article	Page
Bodywork lever	584
Bodywork spoon	584
Bodywork tool set	586
Bolt cutter / SUPER	349
Bolt extractor	468
Bolt extractor set	469
Bordering pliers for welders	537
Bottom anvil tool	445
Bottom fuller	445
Bottom swage	446
Bowden cable cutter	323, 471, 577
Brake caliper brush	574
Brake caliper file	574
Brake spring pliers	574
Brake spring pliers heavy-duty pattern	574
Breaking torque wrench TBN	261
Brick bolster	437
Brick cutting chisel flat oval	451
Bricklayer's chisel	452
Bricklayer's hammer	435, 436
Builder's hatchet	436

C

Cable cutter	506
Cable end-sleeve pliers	334
Cable knife	473, 474
Cable reel hook	43
Cable shears	323, 506
Calibrating tool	529
Caliper face spanner adjustable	140
Carbide scriber	458, 467
Carbide tile chisel	454
Carbide tile hammer pointed or flat	438
Car light tester	305
Carpenter's hammer	436, 437
Cartridge spanner 3-arm pattern	401
Cast iron screw clamp	477
Centre punch	455
Chain grip wrench	379
Chain pipe cutter	583
Chain pipe wrench	523
Check-Tool insert with assortment	90 - 93
3-Chest tool trolley MODULAR SYSTEM	26
Chisel and punch set	456
Chisel holder empty	46
Chisel merchandiser	457
Chisel set in 1/3 tool module	87
Circlip pliers for external retaining rings	340, 341, 344
Circlip pliers for internal retaining rings	342, 343
Circlip pliers in 1/3 tool module	89
Clamping plates for screw clamps	478
Claw gripper	583
Claw hammer, American pattern	437
Club hammer	432, 433
Club hammer ROTBAND-PLUS	432
Cold chisel hammer	445
Combination hammer KOMBI-PLUS R	441
Combination holding tool	141
Combination pliers	314
Combination pliers NC	495
Combination ratchet spanner	107 - 109





Article Index	
Article	Page
Combination ratchet spanner set	107, 109
Combination ratchet spanner set in 1/3 tool module	85
Combination spanner NC	491
Combination spanner set	101, 102, 103
Combination spanner set in 2/3 tool module	85
Combination spanner with same size each end	100, 102, 103
Combination stepped key	536
Combination swivel head wrench	130
Connector pliers	348, 470
Construction ratchet bi-hexagon	210
Contact file	464
Converter 1.1/2" to 2.1/2" for impact sockets	219
Converter 1/2" to 3/4"	186
Converter 1/2" to 3/4" for impact sockets	214
Converter 1/4" to 3/8"	156
Converter 1" to 1.1/2" for impact sockets	217
Converter 3/4" to 1"	203
Converter 3/4" to 1" for impact sockets	216
Converter 3/8" to 1/2"	170
Converter 3/8" to 1/2" for impact sockets	212
Copper hammer	444
Copper hammer ROTBAND-PLUS	444
Copper pipe bending spring	544
Corner valve socket wrench	533
Counter-support	558 - 561
Coupler 1"	208
Coupler 1/2"	187
Coupler 1/4"	156
Coupler 3/4"	203
Coupler 3/8"	171
Coupler and fitting	415
Craftsman scissors	472
Cranked screwdriver	303
Cranked wrench key for multi-spline screws RIBE®	303
Cranked wrench key for recessed TORX® screws	302
Cranked wrench key set for recessed TORX® screws	302, 303
Cranked wrench key with T-handle for recessed TORX® screws	303
Creeper	587
Crimping pliers set	338
Crimping pliers set professional	338, 339
Crimping self-grip wrench	335
Crimp wrench for big terminals	334
Cross-cut chisel	453
Cross tweezers	468
Crosswise divider	42
Crowbar	460
Crowfoot spanner	130
Curved bearing scraper (Long scraper) American pattern	447
Cutter for construction steel mats	349
Cylinder liner puller complete with support brace	397

D

Deburrer	464
Deep ring spanner straight pattern	127
De-solder tool	332
Digital measuring calliper	467
Dismantling and assembly fork	402
Display box 1/2"	197
Display box 1/4"	163
Display box 3/8"	177
Display insert with assortment 1/2"	197

Article Index	
Article	Page
Display rack for hammer	428, 429
Display rack for hammer KOMBI-PLUS R	441
Display stand 1/2" for plastic ratchets	181
Distance module	89
Door element for TANTO 3000	31
Double ended midget spanner	112
Double ended ring spanner	118-120
Double ended ring spanner set	119, 120
Double ended socket wrench offset with hole	132
Double ended wheel wrench	573
Double faced club hammer	433
Double flaring tool set	532
Double open ended spanner	110, 117
Double open ended spanner set	111
Double punch	537
Drain pipe cleaner	541
Drain plug wrench	575
Drawer cabinet	39
DREMOMETER	242
DREMOMETER Sets	242, 243
Drift punch	446, 454
Drift punch set	456
Drill-bit holder	45
Drill holster	484
Drive shaft puller	402
Driving handle	227
Driving handle 1/4"	157
Duo pouch	485

E

Ear plugs with head band	487
Eccentric angle bender 70-120 mm working height	562 - 564
Elbow pipe wrench	521
Elbow pipe wrench ECK-SCHWEDE-snap® - the swedish THE ORIGINAL	520
Electrical conversion kit	559
Electrical limiter	559
Electricians' cable knife	475
Electricians' chisel	453
Electricians' pouch	485
Electricians' side cutter	316
Electricians' splitting chisel	453
Electricians tool case	61, 513
Electronic diagonal cutter	327, 329
Electronic end cutting nippers	327, 329
Electronic mini diagonal cutter	327
Electronic pliers set	325
Electronic screwdriver	296, 297
Electronic screwdriver set	297
Electronic side cutter	326, 327
Electronic torque tester DREMOTEST E	277
Electronic torque wrench TorcoTronic II	276
Electronic tweezers	468
Embossing hammer	585
End fitting	265
End nipper POWER	318
Engineer's ball pein hammer	431
Engineers' hammer	429, 430,
Engineers' hammer ROTBAND-PLUS	428
Engine space lamp	481
Extension 1"	208



Article Index

Article	Page
---------	------

Extension 1/2".....	187
Extension 1/2" for impact sockets.....	214
Extension 1/2" with release.....	187
Extension 1/4".....	156
Extension 1/4" for impact sockets.....	211
Extension 1/4" with release.....	156
Extension 1" for impact sockets.....	218
Extension 3/4".....	203
Extension 3/4" for impact sockets.....	216
Extension 3/8".....	170
Extension 3/8" for impact sockets.....	212
Extension 3/8" with release.....	171
Extension cable.....	559
Extension for 1.51/10 + 11.....	388
Extension NC 1/2".....	493
Extension NC 3/8".....	492
Extension rod.....	390
Extension shaft.....	540
Extension tube.....	129
Extension tubes for DREMOMETER DR - F + W.....	244

F

Fan puller 2-3 arm pattern.....	384, 386
Feeler gauge set, fan pattern.....	466
Figure snips.....	538
File brush.....	469
Fine needle nose electronic pliers.....	328
Fitting hook spanner.....	470
Fitting open ended spanner.....	470
Fittings.....	470
Fittings paring spanner.....	470
Fixed square head 16 Z.....	265
Fixed square head / Ratchet head 22 Z.....	266
Flange separators (pair).....	405
Flared end fitting 16 Z / 22 Z.....	265, 266
Flare nut spanner, open.....	121
Flaring tool boerdex®.....	531
Flat cold chisel.....	450, 451, 496
Flat nose electronic pliers.....	329
Flat nose pliers without wire cutter, serrated.....	319
Flat ring ratchet spanner.....	120
Flat ring spanner.....	120
Flat round face hammer.....	584
Flat scraper.....	448
Flexible extension 1/4".....	156
Flexible milled file blades.....	584
Flexible pipe cleaning shaft.....	540
Folding rule.....	466
Folding workbench.....	38
Friction ratchet handle without insert ring.....	209
Friction type ratchet.....	209

G

Gasket scraper.....	448
Gasket set.....	558
Gauge and gauge holder.....	414
General purpose box.....	46
Geologist's hammer.....	439
Glaziers hammer polished.....	438
Glow plug socket.....	496, 580

Article Index

Article	Page
---------	------

Grey cast iron bending former up to 90°.....	560
Grip c-clamp.....	347
Grip wrench.....	346, 347, 495, 535
Grip wrench set in 1/3 tool module.....	87
Grooving chisel octagonal.....	454
Gutter bending pliers.....	537

H

Hacksaw.....	465, 515
Half-moon ring spanner.....	121
Half-round blunt file.....	464
Hammer holder with metal hooks.....	484
Hammer KOMBI-PLUS.....	431
Hand file.....	464
Hand lamp.....	480-482
Handle for fittings.....	470
Hand-operated impact driver 1/2".....	219
Hand-operated impact driver set 1/2".....	219
Hand ratchet 1/4" without handle.....	151
Hand-turned plumber's snake.....	541
Hard metal tip flat scraper.....	448
Hardy.....	446
Heavy-duty belt set.....	485
Heavy-duty belt with cushion.....	484
Heavy-duty cable stripping tool.....	332
Heavy-duty pipe cutter for stainless steel pipes.....	527
Hexagon Allen key for in-hex screws.....	298 - 303
Hexagon socket key.....	470
Hexagon socket key NC for in-hex screws METRIC.....	494
Hexagon socket key set in 2/3 tool module.....	87
Hexagon socket key set NC.....	494
High-pressure hose.....	414
High-speed pipe wrench.....	348, 521
High-speed swivel disc for 1/2" ratchets.....	186
Hobby saw.....	465
Holder.....	43, 46
Holder for allen keys.....	45
Hole cutting snips.....	538
Hook assortment.....	47
Hooks (pair).....	576
Hook wrench.....	140
Hose clamp pliers.....	577
Hot chisel hammer.....	445
Hubcap removing tool.....	574
Hub cone spanner.....	470
Hydraulic cylinder.....	388
Hydraulic cylinder for heavy-duty pullers.....	414
Hydraulic hand pump.....	388
Hydraulic heavy-duty puller 3-arm pattern.....	411, 412, 413
Hydraulic implements.....	388
Hydraulic oil 1 litre.....	558
Hydraulic press.....	378
Hydraulic pressure spindle.....	378

I

Ideal pattern snips.....	538
Impact bearing puller.....	397
Impact driver set.....	88
Impact screwdriver bit socket 1/2".....	214
Impact screwdriver bit socket 1".....	217





Article Index

Article	Page
---------	------

Impact screwdriver bit socket 3/4"	216
Impact socket 1.1/2" hexagon	218
Impact socket 1/2" for protruding TORX® head screws	214
Impact socket 1/2" hexagon	212, 213
Impact socket 1/4" hexagon METRIC	211
Impact socket 1" hexagon	217
Impact socket 2.1/2" hexagon	219
Impact socket 3/4" hexagon	215
Impact socket 3/8" for protruding TORX® head screws	212
Impact socket 3/8" hexagon	211
Impact socket set 1/2" for cars	215
Impact socket set 3/4" for trucks.	216
Industrial knife	474
Industrial pulling set	406, 407
Industrial scissors professional	472
Insert ring for friction ratchet	209, 210
Installation pliers	583
Installation tripod, pivotable.	559
Installation wrench.	533
Insulating tape	332
Insulating varnish stripper.	332
Internal extractor	395, 396
Internal extractor set	395, 398

J

Joiners' hammer	431
---------------------------	-----

K

Key file set	464
Keyhole saw.	465
Kneeling board	587
Knee pads, pair	485

L

Lead hammer	444
Leather scissors	472
Lengthwise divider slotted	42
Letter and number punches	458
Lever-action end cutting nipper	318
Lever-action side cutter	317
L-handle 1/2"	186
L-handle 3/8"	170
Light metal hammer.	444
Light strip for tool trolleys	41
Link pipe cutter for steel, SML and cast iron pipes	526
Long nose electronic pliers	328
Long reach hammer	585

M

Machine holder for battery screwdriver.	44
Machine workbench clamp	346
Magazine handle screwdriver	227
Magnetic hammer ROTBAND.	439
Magnetic holder	482
Magnetic lifter.	582
Magnetizer and demagnetizer	305
Malleable cast iron shells SOFT-PLUS	442
Manual bending tool set	546 - 550
Manual heavy-duty internal puller set 3-arm pattern.	409
Manual heavy-duty puller 2-3 arm pattern.	409

Article Index

Article	Page
---------	------

Manual pump for heavy-duty pullers.	414
Mechanics pliers 7 settings	350, 524
Mechanics pliers without wire cutter	322
Mechanic's tool assortment.	63, 73, 76
Merchandise for striking tools	457
Miniature electronic diagonal end cutting nippers	330
Miniature electronic pliers.	331
Miniature electronic side cutter	326, 330, 331
Miniature electronic wire stripping pliers	331
Miniature LED lamp with swivel end in plastic box	141
Miniature pipe cutter MINI-QUICK	529
Minibits	220
Minibit set	221
Mini magnetic lifter	582
Mini Torque Multiplier DREMOPLUS	275
Mobile workbench	32 - 36
Modular crimp wrench	336
Module assortment large.	82 - 84
Module insert for coax cables	337
Module insert for conductor end-sleeves	337
Module insert for Dura Seal contacts	337
Module insert for flat plugs	337
Module insert for heavy connectors	337
Module insert for insulated terminals	336
Module insert for lamellar contacts	337
Module insert for modular plugs	337
Module insert for Multi Contact	337
Module insert for non-insulated terminals	336
Module insert for optical waveguides	337
Module insert for Solarlok®	337
Modules empty	279
Motor pump for heavy-duty pullers.	414
Mounting rail for storage boxes	44
Multi fitting Key	138, 139
Multiple pliers	321
Mushroom head / square drive TORCOFIX K.	253

N

Nail lifter octagonal	460
NAUTIC set	497 - 499
Needle nose electronic pliers.	328
Needle nose pliers with wire cutter, serrated	320
Nut driver flexible	134
Nut driver with 3C-handle	135
Nut driver with T-handle	135
Nut splitter.	404
Nut splitter hydraulic	404
Nut splitter set.	404
Nylon hammer.	443

O

Offsetting pliers with punch	586
Oil can.	575
Oil filter hook 3-arm pattern	401
Open ended slogging spanner	122
Open ended spanner set in 1/3 tool module	85
Open end fittings 16 Z / 22 Z / 28 Z.	264, 266, 267

P

Paper roll holder	43
-----------------------------	----





Article Index

Article	Page
Paper scissors	472
Parallel jaw grip wrench	346
Parallel vice	466
Paring chisel octagonal	454
Parts	349, 392, 522, 523, 530 - 535, 541, 546 - 555
Paving hammer	437, 438
Pelican pattern snips	538
Pickup tool for bits	225
Pincer	318
Pin punch	455, 456, 496
Pipe bender set	552
Pipe bender with slide rail / with roller	551
Pipe bending machine 3/8" - 1.1/4"	556
Pipe bending machine 3/8" - 2"	556
Pipe bending machine 3/8" - 3"	557
Pipe bending machine electro-hydraulic	555
Pipe bending machine manual-hydraulic	554, 555
Pipe bending machine MSR 40 - 63 mm	557
Pipe bending pliers	544, 545
Pipe cutter	528, 530
Pipe cutter niro for stainless steel pipes	527
Pipe cutter QUICK AUTOMATIC	529
Pipe cutter QUICK AUTOMATIC niro for stainless steel pipes	527
Pipe cutter TUBEX® for SML and cast iron pipes	526
Pipe cutter TUBEX® for steel pipes	526
Pipe deburring reamer	527, 529
Pipe shears for plastic pipes	530
Pipe straightening tool MSR	565
Pipe wrench American pattern	520 - 522
Piston ring compressor	576
Piston ring pliers	576, 577
Planishing hammer	584, 585
Plastic cassettes empty for DREMOMETER MINI + AM	278
Plastic hammer	443
Plastic ratchet 1/2"	180
Plastic ratchet 3/8"	165
Pliers for brake cable springs	574
Pliers for valve seals	576
Pliers set + accessories	339
Pliers set	352 - 356
Pliers set in 1/3 tool module	87
Plug-in blade 1/4" hex	304
Plug-in blade hex for cross-slotted head screws PH / PZ	304
Plumber's wrench	536
Plumbing wrench	535
Plus-Form handle	141
Pocket knife	473, 474
Pocket vernier calliper	467
Point chisel octagonal	452, 453
Point pein hammer	585
Power combination pliers	315
Power side cutter American pattern	317
Power side cutter NC American pattern	495
Precision crimping wrench for conductor end-sleeves	334
Precision crimp wrench	334
Precision mechanics in 1/3 tool module	87
Precision stripping tool for data cables	333
Precision tweezers	468
Pressure pad set for puller	415
Professional plastic bearing installation set	379
Profi-key universal	138

Article Index

Article	Page
Profile-section grip wrench	347
Protective hand guard	450
Prybar	459
Puller 2-3 arm pattern	381 - 385
Puller for hydraulic implement 1.50	389
Puller hydraulic, 2-3 arm pattern	383, 385
Puller NC 2-arm pattern	496
Puller set	365, 370, 374, 375, 406
Puller set in 1/3 tool module	89
Puller TWIST+PULL 3-arm pattern	380
Puller with clamping yoke	386, 387
Pulling chuck	405
Pulling flange	402
Pulling flange heavy-duty pattern	402
Pulling leg	381 - 385
Pulling legs	393
Pulling set for construction machines Add-on system	407
Pump electro/manuel -hydraulic	558
Punch hammer	446
Punch pliers	586

Q

Quick-clamp wrench	535
Quick-release lever clamp	479
Quick-release puller 2-3 arm pattern	369, 272, 273
Quick-release pulling leg	365
Quick-turn with T-grip DREH-FIX TORCOFIX K	253

R

Radiator valve spanner	536
Ratchet handle with coupler 1"	206
Ratchet handle with coupler 1/2"	180
Ratchet handle with coupler 1/4"	151
Ratchet handle with coupler 3/4"	201
Ratchet handle with coupler 3/8"	165
Ratchet heads 16 Z / 28 Z	265, 267
Ratchet heads DREMOMETER	244
Ratchet pipe cutter niro for stainless steel pipes	527
Ratchet with T-handle	151, 165
Rear panel	31, 38
Recoilless hammer / impact tool	440, 441
Recoilless impact tool	441
Rectangular bit holder	268, 269
Rectangular fixed square head	268, 269
Rectangular flared end fitting	268
Rectangular open end fitting	268, 269
Rectangular reversible ratchet head	268, 269
Rectangular ring end fitting	268, 269
Rectangular weld-on fitting	268, 269
Reducer 1.1/2" to 1" for impact sockets	218
Reducer 1/2" to 3/8"	186
Reducer 1/2" to 3/8" for impact sockets	214
Reducer 1" to 3/4"	207
Reducer 1" to 3/4" for impact sockets	217
Reducer 2.1/2" to 1.1/2" for impact sockets	219
Reducer 3/4" to 1/2"	203
Reducer 3/4" to 1/2" for impact sockets	216
Reducer 3/8" to 1/4"	170
Reducer 3/8" to 1/4" for impact sockets	212
Retaining clip for nuts	141





Article Index

Article	Page
Reversible lever change ratchet	210
Reversible ratchet 1"	206
Reversible ratchet 1/2"	178, 179, 492
Reversible ratchet 1/4"	150
Reversible ratchet 3/4"	200
Reversible ratchet 3/8"	164, 493
Ring bending machine	565
Ring end fitting	264, 266, 267
Ring slogging spanner	124, 126
Ring spanner set in 1/3 tool module	85
Rivet setter octagonal	458
Rivetting setter	458
Rivetting snap die	458
Rivetting tongs	447
Roll-cover	485
Roller tool case	51
Round file	464
Round holder	45
Round nose electronic pliers	329
Round nose pliers serrated	319
Rubber mallet	443

S

Safety coil spring compressor	403
Safety cover size 1	379
Safety hammer SOFT-PLUS	442
Safety knife	475
Safety ring and safety pin for impact sockets 1"	218
Safety ring and safety pin for impact sockets 1.1/2"	219
Safety ring and safety pin for impact sockets 1/2"	215
Safety ring and safety pin for impact sockets 1/4"	211
Safety ring and safety pin for impact sockets 2.1/2"	219
Safety ring and safety pin for impact sockets 3/4"	216
Safety ring and safety pin for impact sockets 3/8"	212
Safety spectacles	487
Sanitary installation set	534
Sanitary tool assortment	66, 67
Saw holder	45
Scaling hammer	439
Scraper	475
Screwdriver set in 1/3 tool module	88
Screwdriver bit for cross-head screws PH / PZ	224
Screwdriver bit for cross-slotted head screws PH / PZ	222, 228
Screwdriver bit for in-hex screws	222, 223, 228
Screwdriver bit for multi-point screws XZN	223, 228
Screwdriver bit for multi-spline screws RIBE®	223, 228
Screwdriver bit for recessed TORX® head screws	223, 224, 229
Screwdriver bit for slotted head screws	222, 223, 228
Screwdriver bit socket 1/2" for cross-slotted head screws PH / PZ	184
Screwdriver bit socket 1/2" for in-hex screws	184, 185
Screwdriver bit socket 1/2" for multi-point screws XZN	185, 186
Screwdriver bit socket 1/2" for multi-spline screws RIBE®	185
Screwdriver bit socket 1/2" for recessed TORX® head screws	183, 184
Screwdriver bit socket 1/2" for slotted head screws	184
Screwdriver bit socket 1/2" with ball end, for in-hex screws	185
Screwdriver bit socket 1/4" for cross-slotted head screws PH / PZ	155
Screwdriver bit socket 1/4" for in-hex screws	155
Screwdriver bit socket 1/4" for recessed TORX® head screws	154
Screwdriver bit socket 1/4" for slotted head screws	155
Screwdriver bit socket 1/4" with ball end	154, 155
Screwdriver bit socket 1" for in-hex screws	207

Article Index

Article	Page
Screwdriver bit socket 3/4" for in-hex screws	202
Screwdriver bit socket 3/4" for recessed TORX® head screws	202
Screwdriver bit socket 3/8" for cross-slotted head screws PH / PZ	168
Screwdriver bit socket 3/8" for in-hex screws	169
Screwdriver bit socket 3/8" for multi-point screws XZN	169
Screwdriver bit socket 3/8" for recessed TORX® head screws	168
Screwdriver bit socket 3/8" for slotted head screws	168
Screwdriver bit socket 3/8" with ball end, for in-hex screws	169
Screwdriver bit socket set 1/2" + 1/4"	196
Screwdriver bit socket set 1/2"	195, 196, 198
Screwdriver bit socket set 1/2" in 1/3 tool module	86
Screwdriver bit socket set 1/4"	158
Screwdriver bit socket set 3/8" + 1/4"	176
Screwdriver bit socket set 3/8"	176
Screwdriver bit socket set 3/8" in 1/3 tool module	86
Screwdriver for cross-slotted head screws PH / PZ	291, 292, 296
Screwdriver for slotted head screws	291, 296
Screwdriver sales stand	293, 294
Screwdriver set	296
Screwdriver set in 1/3 tool module	88
3C-Screwdriver for cross-slotted head screws PH / PZ	291
3C-Screwdriver for in-hex screws, with ball end	292
3C-Screwdriver for recessed TORX® head screws	292
3C-Screwdriver for slotted head screws	291
3C-Screwdriver NC for cross-slotted head screws PH	494
3C-Screwdriver NC for slotted head screws	494
3C-Screwdriver set	293, 295
3C-Screwdriver with striking cap for cross-slotted head screws PH / PZ	295
3C-Screwdriver with striking cap for slotted head screws	295
Screw extractor set	468
Scriber	467
Scythe anvil	446
Scythe hammer	446
Seaming pliers	537
Separator and puller set	391
Separator puller	390
Set combination swivel head wrenches in 1/3 tool module	87
Set flare nut spanners, open in 1/3 tool module	87
Set for precision mechanics 1/4" + 4 mm	161
Set hammer	445
Set impact sockets 1/2" in 1/3 tool module	86
Set of arc punches	539
Set of circlip pliers	355 - 357
Set of internal and external extractors	398, 407
Set of rivetting setters and snap dies	458
Set of spark plug sockets 3/8"	580, 581
Set of threaded inserts for 1-hole and 2-hole uses, 2 each	405
Set of threaded inserts for 1-hole uses	405
Setting punch	459
Shears set for plastic pipes	530
Sheet metal case empty	278, 279
Shelf	44
Side cutter	316
Single ended ring spanner offset	128
Single ended ring spanner set	129
Single open ended spanner	114, 115
Single punch	537
Siphon trap pliers / Spring hook wrench	470
Sledge hammer	434, 435
Sliding T bar 1"	207
Sliding T bar 1/2"	186





Article Index

Article	Page
Sliding T bar 1/4"	156
Sliding T bar 3/4"	203
Sliding T bar 3/8"	170
Sliding T bar NC 1/2"	493
Sliding T bar NC 3/8"	492
Sliding T bar with release 1/2"	186
Sliding T bar with release 1/4"	156
Sliding T bar with release 3/8"	170
Small combination pliers	314
Small-parts drawer for tool trolleys	41
Small saw for metal	465
Small universal scissors	473
Smoothing hammer	585
Socket 1/2"	182, 183
Socket 1/4"	152 - 154
Socket 1"	207
Socket 3/4"	201, 202
Socket 3/8"	166, 167
Socket holder	44, 226
Socket NC 1/2"	493
Socket NC 3/8"	492
Socket set 1/2"	189 - 196, 198, 199
Socket set 1/2", in 1/3 tool module	85, 86
Socket set 1/4" + 1/2"	194 - 162
Socket set 1/4" in 1/3 tool module	86
Socket set 1"	208
Socket set 3/4"	204, 205
Socket set 3/8" + 1/4"	175
Socket set 3/8"	172 - 177
Socket set 3/8" in 1/3 tool module	86
Socket wrench offset	132
Socket wrench set in 1/3 tool module	88
Socket wrench solid	133, 134
Soft face cap	431, 433
Solar installation kit	62
Spanner holder	45
Spanner set	112
Spare bending former	544
Spare bulb	483
Spare chain BOSS	523
Spare handle	430, 432, 434
Spare handle ash for no. 226+227	443
Spare handle for no. 224+225	443
Spare handle hickory	440
Spare handle ROTBAND-PLUS	428, 432, 434
Spare handle SOFT-PLUS	442
Spare head (piece)	440
Spare head SOFT-PLUS	442
Spare parts	526 - 530
Spare parts for 60 CP / 60 P / 62 P	113
Spare rubber suction cup for 653 and 654	576
Spare strap	523
Spare tapered collar	429
Spare tips for external retaining rings (per piece)	344
Spark plug brush	581
Spark plug gauge	467
Spark plug socket	580
Spark plug socket 3/8" UD profile	580
Spark plug socket 3/8" with hexagon drive	580
Spark plug socket NC	496
Spark plug socket with magnet	580

Article Index

Article	Page
Spark plug socket wrench	581
Spark plug socket wrench NC	496
Special body grip wrench	346
Special grip wrench	346
Special pin punch	583
Special scissors	473
Special siphon pliers	535
Special strap wrench	575
Special water pump pliers 5 settings	351
Speed brace 1/2"	186
Speed brace 3/8"	170
Spindle pressure pads for axle bores (hollow shafts)	379
Spindle summary	378
Splitting chisel	451
Spring clamp	42
Spring spreader	403
Spring steel socket rail	171, 188
Square bladed awl	305
Square flatter	445
Stand ashtray	47
Steel bending former up to 90° / 180°	560, 561
Steel / rubber hammer	585
Steel tape measure	466
Steering-wheel puller	402
Stepped key	536
Stepped tommy bar	137
Stone sledge hammer	435
Storage tray	46
Straightening counter-support (Pair)	561
Straightening tool	561
Strap wrench	523, 575
Stripping pliers	324
Stripping pliers for power lines	332
Stripping pliers STRIP-FIX	324
Stripping pliers with exchangeable module inserts, self-adjusting	333
Stripping tool for coaxial cables	333
Stud extractor	404
Stud screw inserter	533
Stud screw wrench	533
Suction cup lifter	582
Supplementary tool assortment for S 1400 GM	65
Support brace	397
Swivel handle 1/2"	187
Swivel handle 1/4"	157
Swivel handle 3/4"	203
Swivel handle 3/8"	171
Swivel handle 3/8"	171
Swivel handle with sliding T 1/2"	188
Swivel head reversible ratchet 1/2"	179, 180
Swivel head reversible ratchet 3/8"	165
Swivel head socket 3/8" for protruding TORX® head screws	167
Swivel head wrench double ended	131
Swivel head wrench set in 1/3 tool module	87
Swivel socket 1/4" UD profile	153
Swivel socket 3/8" UD profile	167

T

Tap and die set	469
Taper punch octagonal	459
Tap reseating tool	535
Telephone pliers NC	495





Article Index	
Article	Page
Telephone pliers without wire cutter, serrated, straight pattern	321
Telescopic bonnet support	482
Telescopic extension 1/4" magnetic	157
Terminal-extraction tools	578
Thread file	468
Thread gauge	467
Three-edged bearing scraper	447
Three-edged flat ground scraper	448
Three-edged hollow ground scraper	448
Three-pouch belt set	484
Three-square scraper	448
Tile chisel flat	454
Tile chisel pointed	454
Tile hammer pointed or flat	438
Tiler's setting tool	458
Tin snips	538
Tommy bar	134, 136
Tool assortment	62, 68, 514
Tool assortment AUTODOCTOR	59
Tool assortment for construction machines	77
Tool assortment for Mechanical Engineers	512
Tool assortment for mechatronics	72
Tool assortment for tractors	69
Tool assortment for trucks	71
Tool assortment INCH	77
Tool assortment KFZ	74
Tool assortment NFZ	75
Tool box	31, 49
Tool box 3 compartments	48, 60
Tool box 5 compartments	48, 60, 61
Tool box JUMBO	50
Tool cabinet	40
Tool case	51
Tool case electrician	59, 512
Tool case TOURING	58
Tool chest	30, 49
Tool chest for mobile use	30
Tool holder	45
Tool holder double	43, 44
Tool holder empty for 8 spanners	46
Tool holder for 3 cans	44
Tool holder for pliers	44
Tool holder for screwdrivers	44
Tool holder vertical hook end	44
Tool holding rail, magnetic 1/2" empty	188
Tool holding rail, magnetic 1/4" empty	157
Tool holding rail, magnetic 3/8" empty	171
Tool hook for sockets	45
Tool hook inclined hook end	42, 44
Tool hook straight mandrel	42, 43
Tool module 1/4" with assortment	86, 91
Tool module empty	30, 49, 89
Tool panels for tool assortment	79 - 81
Tool rucksack	486
Tool set	354
Tool set for bicycle	471
Tool tray	46
Tool trolley	18, 20
Tool trolley and tool chest	24
Tool trolley DUO with 4 drawers	25
Tool trolley TANTO with 7 drawers	23

Article Index	
Article	Page
Tool trolley VARIO with lowering mechanism	27
Tool trolley with 4 - 8 drawers	22, 25, 28, 29
Tool vest	486
Top fuller	445
Top swage	446
Torque angle indicator	245
Torque calibration analyser DREMOTEST	277
Torque Limit Unit 3/8"	245
Torque Multiplier DREMOPLUS	273
Torque Multiplier DREMOPLUS	274
Torque Multiplier DREMOPLUS	275
Torque screwdriver handle	304
Torque screwdriver set	305
Torque screwdriver Type FS	259
Torque screwdriver Type S	259
Torque screwdriver Type S	259
Torque screwdriver Type SP	259
Torque wrench DREMOMETER AM - F	240
Torque wrench DREMOMETER A+S	248
Torque wrench DREMOMETER MINI	236
Torque wrench DREMOMETER SE A+S	249
Torque wrench DREMOMETER SE with quick-fitting change	247
Torque wrench DREMOMETER T-FS pre-set	237
Torque wrench DREMOMETER Z A+S	249
Torque wrench DREMOMETER Z with quick-fitting change	246
Torque wrench for pre-setting TORCOFIX FS	257
Torque wrench set TORCOFIX K	253
Torque wrench set TORCOFIX SE	257
Torque wrench set TORCOFIX Z	255
Torque wrench TORCOFIX K / UK / K US	252
Torque wrench TORCOFIX SE	256
Torque wrench TORCOFIX Z	254
Torque wrench TSC SLIPPER	262
Torque wrench TSN SLIPPER	260
Torque wrench TSP SLIPPER	262
Torque wrench Type 88	262
Torque wrench with slave pointer Type 83	263
TORX® Gauge	303
Tower pincer	318
Track alignment gauge	403
Transport cart	413
Transport frame zinc-plated	50
Tray	31, 43
Triangular file	464
Tripod stand, zinc-plated	483
Tri-T Hexagon Allen key for in-hex screws	298
Truck workshop set Add-on system	406
Tube holder	45
Tubular box spanner	136
Tubular box spanner heavy-duty pattern	137
Tubular box spanner set with tommy bars	136, 137
Tweezers	468
Tyre lever	574
Tyre removing tool	403

U

Under-gloves for VDE 912	514
Universal 4-way wheel wrench for cars and small trucks	572
Universal ball joint puller	401
Universal basin wrench	534
Universal cable knife	332





Article Index

Article	Page
Universal canister	583
Universal coil spring compressor	403
Universal extension 1/2"	187
Universal extension 1/4"	156
Universal extension 3/8"	171
Universal filter wrench	575
Universal hand saw	465
Universal joint 1"	208
Universal joint 1/2"	187
Universal joint 1/2" for impact sockets	214
Universal joint 1/4"	157
Universal joint 1" for impact sockets	218
Universal joint 3/4"	203
Universal joint 3/4" for impact sockets	216
Universal joint 3/8"	171
Universal joint 3/8" for impact sockets	212
Universal knife	474
Universal pipe bender	551
Universal pliers	350, 469, 524
Universal pliers 5 / 7 settings	350, 351, 524, 525
Universal pouch	484
Universal prybar	459
Universal puller 2-3 arm pattern	365, 368, 371, 380
Universal puller for hydraulic implement 1.50	389
Universal puller HIGH POWER	367
Universal puller hydraulic, 2- 3 arm pattern	370, 373
Universal seaming pliers	537
Universal tool assortment	64, 65
Universal tool assortment INCH	78
Universal Torque Multiplier DREMOPLUS	272
U-yoke	559

V

Valve feeler gauge	467
Valve grinder	576
Valve holder venti-quick	533
Valve lapping tool	576
Valve spring compressor	576
VDE Cable knife	515
VDE Cable shears with VDE dipped insulation	507
VDE electricians' safety gloves	514
VDE Electricians' side cutter with VDE insulating sleeves	508
VDE Extension 1/2"	505
VDE Flat nose pliers	509
VDE Heavy duty combination pliers	508
VDE Heavy duty end cutting nippers	508
VDE Hexagon Allen Key for in-hex screws	505
VDE Insulation mat	514
VDE meter connection fittings	515
VDE Needle nose pliers	509, 510
VDE Plastic clamp	515
VDE pliers set	510, 511
VDE pliers set in 1/3 tool module	87
VDE Power side cutter	508, 509
VDE Reversible ratchet 1/2" with push-button release	505
VDE Round nose pliers	509
VDE Rubber cover sheet	514
VDE Screwdriver bit socket 1/2" for in-hex screws	505
VDE Screwdriver for cross-slotted head screws PH / PZ	506
VDE Screwdriver for slotted head screws	506
VDE Screwdriver set	506

Article Index

Article	Page
VDE Screwdriver set in 1/3 tool module	88
VDE Side cutter	508
VDE Single ended ring spanner deep offset	504
VDE Single open ended spanner	504
VDE Socket 1/2"	505
VDE Socket wrench with 3C-handle	504
VDE Stripping pliers STRIP-FIX	507
VDE Stripping pliers	507
VDE T-handle for 1/2" VDE tools	505
VDE Tool cabinet	513
VDE Tool set	511
VDE Torque wrench 1/2"	504
VDE Universal pliers 7 settings	507
Veneer hammer	438
Vernier calliper, small	467
Voltage tester	305, 579
Voltage tester 1000 V two-pole with LED display	506

W

Watchmaker tweezers	468
Water pump pliers	351, 525
Water pump pliers NC	495
Weather Proof Multi Tool for NAUTIC-Sets 502+503	496
Welder's grip wrench	347
Wheel-hub puller for cars and trucks	399
Wheel socket wrench for trucks	573
2-, 4- way wheel wrench	572, 573
Wide jaw grip wrench	346
Wing protector	587
Wire brush	469
Wire stripping knife	332
Wire twisting pliers	348
Wooden mallet	444
Wood plate	31
Workbench with drawer cabinet	39
Workbench with tool cabinet	37
Work gloves FastFit	487
Work gloves M-Pact	487
Work gloves Original	487
Working piston extension	561
Work knife	474
Worklamp Power / Mega Power	482, 483
Wrecking bar octagonal	460
Wrench for pedals	470
Wrench for plumbing fittings	535
Wrench for spokes	470
Wrench key with T-handle for recessed TORX® screws	302
Writing support	41

X

X-GRIP Circlip pliers	345
X-GRIP Circlip pliers set	345
X-GRIP Parts	345





INDEX	
Article No.	Page
1 B	100, 101
1.04/B	365
1.04/HP	367
1.04/HP-B	367
1.04/HP-B-HSP	367
1.04/ST	365
NC 1.04	496
1.06	368
1.06/AS	370
1.06/B	368
1.06/E	369
1.06/H	389
1.06/HSP	370, 378
1.06/HSP-B	370
1.06/S-E	369
1.06/ST	370
1.06/XS-E	369
1.07	371
1.07/4	371
1.07/AS	374
1.07/B	371
1.07/E	372
1.07/HSP	373
1.07/K	374
1.07/K-B	375
1.07/K-HSP	375
1.07/K-SE	374
1.07/K-SE S	375
1.07/S-E	372
1.07/XS-E	373
1.08	380
1.09	380
1.10	381
1.11	381
1.12	382
1.13	382
1.14	383
1.14/L	384
1.15	383
1.15/H	389
1.15/HSP	383
1.15/L	384
1.16	384
1.16/HSP	385
1.17	384
1.17/H	389
1.17/HSP	385
1.18	385, 386
1.18/1.19	406
1.18/XS	387
1.19	385, 386
1.19/SH	386
1.19/XS	387
1.20	386
1.22	386
1.23	387
1.23/XS	387
1.26	404
1.26/HYD	404
1.26/K	404
1.28	404
1.28/4	404
1.29	393
1.29/K	393
1.30/0-9	396
1.30/10	396

INDEX	
Article No.	Page
1.30/N	396
1.31	398
1.32/1-2	398
1.34/1 - 1.34/4	395
1.34/10	395
1.35	397
1.36	397
1.37	397
1.38	390
1.38/HSP	390
1.38/V	390
1.40	391
1.41	391
1.44	405
1.50	388
1.50/1	388
1.51	388
1.51/V	388
1.55	378
1.60	399
1.60/HSP	399
1.61	399
1.61/HSP	399
1.62	399
1.62/HSP	399
1.64	402
1.65	402
1.66	402
1.67	402
1.68	402
1.70	402
1.72	401
1.73	401
1.74	401
1.75	401
1.76	401
1.78/P	403
1.78/S	403
1.79	403
1.80	379
1.81/1 + 2	405
1.81/10 + 20	405
1.81/K	405
1.85/1	379
1.90	405
1.91	403
1.92	392
RZB1-1	353
RZB1-2	353
RZB1-3	356
RZB1-10	354
RZB1-11	356
RZB1-15	354
RZB1-16	354
RZB1-17	511
RZB1-18CR	339
RZB1-19	357
RZB1-20	357
RZB1-21	354
VH 1	46
WVH 1	46
2	118, 119
2.A	128
2 AR	129
2 ATM	129
2 B	119

INDEX	
Article No.	Page
2.10	406
2.20	406
2.30	406
2.30-B	407
2.40	407
2.50	407
RZB2-5	510
RZB2-11	511
RZB2-12	353
VDE 2 E	504
3.01	403
4	120
4 E + 4 H	429
4 IH	429
4 K	430
4 R	120
4 E + 4 H	430
4 K	430
TX 4	120
5.10	379
E 5	429
6	110, 111
6 NA	431
H 6	46
7	102
7 R	107
7 R-005	107
7 R-012	107
7 RA - 7 RB	109
7 R XL	108
7 R XS	108
7 UR	108
7 UR-012	109
7 UR XL	109
7 UR XS	109
7 XL	103
NC 7	491
8	112
8-011	112
8-0100	112
8.01	413
8.06	409
8.06/580-155	415
8.06/780-257	415
8.06/880-508	415
8.07	409
8.07/HYD	411
8.07/HYD-E	413
8.07/HYD-M	412
8.07/HYD-P	412
8.07/HYD-Z	411
8.31/1	409
8.51	414
8.52	414
8.53	414
8.54/1	414
8.54/2	414
8.55/3	414
9 E + 9 H	434
E 9 E + E 9 H	434
9 F	435
10 E + 10 H	435
17 E	435
18 E	438
19	182
19 CMU / D 19 CMU	194





INDEX	
Article No.	Page
19 E.....	438
19 EMU / D 19 EMU.....	192
19 FMU / D 19 FMU.....	191
19 GMU.....	189
19 HMU / D 19 HMU.....	189
19 IMU / D 19 IMU.....	193
19 KMU / D 19 KMU.....	189
19 L.....	183
19 LMU.....	194
19 PQMU / D 19 PQMU.....	190
19 QMU / D 19 QMU.....	191
19 TM / D 19 TM.....	193
19 TX 20.....	196
19 V20U-10.....	194
19 WMU / D 19 WMU.....	192
D 19.....	182
D 19 L.....	183
D 19 L-015.....	195
D 19 TA.....	198
D 19 WAU.....	198
D 19 XMA.....	199
D 19 YMAW.....	199
IKS 19.....	184
IKS 19 PZD.....	184
IN 19.....	184
IN 19 K.....	185
IN 19 L.....	185
IN 19 LK.....	185
IN 19 LKM.....	195
IN 19 PA.....	198
IN 19 PM.....	195
IN 19 Q.....	195
IN K 19.....	214
INR 19 L.....	185
INX 19.....	185
INX 19 L.....	186
INX 19 PM.....	195
IS 19.....	184
ITX 19.....	183
ITX 19-20-30 T.....	196
ITX 19 B.....	184
ITX 19 L.....	184
ITX 19 LKP.....	196
ITX 19 PM / ITX 19 B-PM.....	195
ITX 19 TX-017.....	196
ITX K 19.....	214
K 19.....	212
K 19-028.....	215
K 19 L.....	213
K 19 LD.....	213
K 19 LS.....	213
KR 19.....	213
NC 19.....	493
NC D 19.....	493
SL 19.....	188
TX 19.....	183
TX 19 E-09.....	196
TX K 19.....	214
VB 19 M / VBD 19 M.....	197
VBE 19 INL.....	197
VBI 19 M.....	197
VBTX 19.....	197
VDE 19.....	505
VDE IN 19.....	505
VH 19.....	188
VS 19 H.....	46

INDEX	
Article No.	Page
20.....	152
20 E + 20 H.....	432
20 EAU-3.....	162
20 EM.....	162
20 F.....	433
20 IMU-3.....	162
20 ITU-3.....	163
20 L.....	153
20 LMU-10.....	161
20 ST.....	433
20 XLU-3 T.....	160
D 20.....	153
D 20 DM.....	158
D 20 DMU-3.....	158
D 20 DMU-3 T.....	158
D 20 EMU-3.....	159
D 20 FMU-20.....	161
D 20 KAU-20.....	159
D 20 KMU-20.....	159
D 20 MOT.....	159
D 20 MOT-A.....	159
D 20 TMU-10.....	160
D 20 WMU-3.....	161
DG 20.....	153
E 20 E + E 20 H.....	432
IN 20.....	155
IN 20 K.....	155
IN 20 L.....	155
IKS 20.....	155
IKS 20 PZD.....	155
INS 20 PM.....	158
IS 20.....	155
ITX 20.....	154
ITX 20 IP.....	154
ITX 20 K.....	154
ITX 20 PM.....	158
ITX 20 TX-015.....	158
K 20.....	211
TX 20.....	154
VB 20.....	163
VS 20.....	163
21.....	433
21.....	473
21 F.....	444
D 21.....	207
D 21 EMU-10.....	208
IN 21.....	207
IN K 21.....	217
K 21.....	217
K 21 L.....	217
22 H.....	444
23 E.....	444
25.....	132
25 PK.....	132
25 V.....	132
26 D.....	136
26 R.....	136
26 RS.....	137
KD 26 R.....	136
27.....	573
28 CU.....	573
28 L - LM - LV.....	573
28 LR + 28 LRV.....	573
28 LRZ.....	573
28 PKH.....	572
28 PR + 28 PRV.....	572

INDEX	
Article No.	Page
28 PU + 28 PUV.....	572
28 PX.....	573
29.....	210
29 E.....	435
29 ST.....	435
30.....	166
30 DMU / D 30 DMU.....	172
30 GMU / D 30 GMU.....	172
30 E.....	435
30 HMU / D 30 HMU.....	173
30 IMU / D 30 IMU.....	174
30 QMU / D 30 QMU.....	174
30 TX 20.....	176
D 30.....	166
D 30 DAU.....	177
D 30 GAU.....	177
D 30 KMU-20.....	175
D 30 L.....	167
D 30 TX20 U-20.....	175
DG 30.....	167
IKS 30.....	168
IKS 30 PZD.....	168
IN 30.....	169
IN 30 L.....	169
IN 30 LK.....	169
IN 30 LKM.....	176
INX 30.....	169
INX 30 L.....	169
IS 30.....	168
ITX 30.....	168
ITX 30 B.....	168
ITX 30 L.....	168
ITX 30 LKP.....	176
ITX 30 PM.....	176
ITX 30 TX-015.....	176
K 30.....	211
NC 30.....	492
NC D 30.....	492
TX 30.....	167
TX 30 E-08.....	176
TXG 30.....	167
TX K 30.....	212
VB 30 / VBD 30.....	177
VH 30.....	171
31 K.....	209
31 KR.....	209
31 KVR.....	209
31 R.....	209
31 VR.....	210
32.....	201
32 EM / D 32 EM.....	204
32 FM / D 32 FM.....	204
D 32.....	202
D 32 EA.....	205
D 32 EMAU-2.....	205
IN 32.....	202
IN 32 L.....	202
IN K 32.....	216
K 32.....	215
K 32-040.....	216
K 32 L.....	215
ITX 32.....	202
33 F.....	134
33 T.....	135
33 TLM.....	135
TX 33 T.....	135





INDEX		INDEX		INDEX	
Article No.	Page	Article No.	Page	Article No.	Page
34	131	NC 49	496	107	456
IN 34	131	50	445	108 UNI	450
ITX 34	131	50 - 57	580	109	452
TX 34	131	50 MH - 59 MH	580	109 HS	452
35 A - DS 35 A	133	NC 50 - NC 54	496	110	452
35 B - DS 35 B	133	51 E	445	110	381
35 D	134	S 51 GU	580	110 HS	452
35 H	437	53	445	111	452
V 35 A - DSV 35 A	134	53 S	580	111 HS	453
V 35 B - DSV 35 B	134	54 E	446	112	453
36	575	55	446	112	382
36	523	D 55	580	112 A	453
36 Z	575	56	473	112 S	453
37 + 37V	575	56 E	446	113 - 113 D	456
37 E	445	S 56 U-10 K	581	114	455
K 37	218	58	446	114	383
K 37 L	218	58	581	114/L	384
38	574	59	446	115	455
38	473	59 GK	580	116	385
38 E	445	59 - 67	474	116 A - 116 L - 119 L	456
39	574	NC 59 GK	496	117	474
40	140	60 CP	113	119	455
40 Z	140	60 P - 62 P	113	NC 119	496
41 - 41 B	210	60 S	113	120	460
41 E	439	60 E - 61 E	446	120	523
41 V - 41 BV	210	E-60	113	E 120	523
42	299, 300	NC 60 P	491	121	460
42	473	V 60 CP	504	121	582
42 EL	300	62 - 63	446	121-3	582
42 KEL	300	E-62	113	121 G	582
42 T	298	63	474	121 G-3	582
42 TX	302	K 64	219	122	460
42 X	303	65 E	431	122	523
42 Z	300	71 GSTM	437	E 122	523
DT 42	298	72 H	438	123	460
DTT 42	298	75 GSTM	436	124	460
H 42	301	75 ST + 75 STM	437	124	576
H 42 - H 42 KEL	301	75 STK + 75 STKM	437	125	576
NC 42	494	76 ST	439	125 B	458
NC H 42-10	494	77 E	439	126	458
NC H 42-88 A	494	77 ST	439	126	576
PH 42-88	301	79	437	126	523
S 42	301	S 89	578	E 126	523
SCL 42	301	90 HS	458	127	577
VDE 42	505	93 ST	436	127	458
43	303	94 E	436	128	454
43 E	438	94 ST	436	128	576
43 KTX	302	95	450	E-128	576
43 TX	302	95 HS	450	129	454
43 TX-09	302	95 N	450	130	447
DT 43 KTX	303	95 NHS	450	131	447
H 43 TX - H 43 KTX	302	96	453	132	448
NC SCL 43 TX-80	494	97	451	132	577
SCL 43 TX-80	303	NC 97	496	132-2 / -3	577
44	140	98	453	132-4	577
45 B	139	99	454	132 CLIC	577
45 E	139	100	455	133	122
45 P	138	100	520	133 D	448
45 S	138	100 A	455	133 F	448
45 U	139	101	455	133 H	448
46 E	433	102	456	133 K	448
47	473	103	451	134	448
48 E	445	104	451	134	577
D 48	581	104/E	365	134 B	577
49 E	445	105	451	134 K	448
DS 49	581	106 - 106 D	456	135	459





INDEX	Page
Article No.	
135	574
136	459
136 BM	346
136 K	379
136 SP	347
137	346, 347
137	459
137 ISOCUT	332
137 K	346
137 KR	346
137 MSP	346
137 P	346
137 T	347
NC 137	495
138	347
138	459
138 X	347
138 Y	347
138 Z	347
139	346
139	459
140	459
140	468
141	459
S 141-3	459
142	459
142	350
142	524
143	350
143	524
144	350
144	524
145	351
145	525
NC 145	495
146	351
146	525
146 B	525
146 B	351
VDE 146	507
147	296
147-04	296
147-162-05	296
148	296
149	305
150	460
151	460
152	460
152	348
152	521
152 G	521
152 G	348
152 NI	521
152 NI	348
156 S	305
162	296
164 IN	297
165-171-06	297
165 PH	297
165 TX	297
165 TX-06	297
169	227
171 IS	296
173	303
174	303
175	521

INDEX	Page
Article No.	
175	475
176	521
177	349
178	349
179	475
180	506
202	454
203	454
206	458
207	454
208	458
210	526
E 210	526
212 E	438
213 H - 214 H	438
216 K	443
218	527
E 218	527
220	526
E 220 - E 223	526
221	526
222	526
223	526
223 H	444
224	527
224 E	443
E 224 E	443
E 224	527
225	522, 527, 528
225 E	443
E 225	522, 527, 528
226 E	443
E 226 E	443
227	522, 530
227 E	443
E 227	522, 530
228	444
228	528
E 228	528
229	444
229	528
E 229	528
230	447
231	447
231	529
E 231	529
232	447
233	447
E 233	531
234	447
234	532
E 234	532
239	529
240	551
243	546
E 243	546
244	547
E 244	547
VS 245 H	46
246	474
246	554
E 246	554
247 H	441
VS 247 H	441
248 F	440
248 H	440

INDEX	Page
Article No.	
248 KL	441
248 ST	440
E 248	440
E 248 H	440
249	555
E 249	555
250	442
E 250	442
E 250 H	442
E 250 T	442
251	584
252 - 297	584
254	558, 559
E 254	558
255 - 256	556
E 255 - E 260	558, 559
257 - 258	556
258	557
259 - 260	557
260	586
261	584
265	584
PR 265 - PR 345	581
268	559
269	558
269	584
269 F	584
271	585
272 - 273 - 274	585
275 - 276	585
276	551
E 276	551
277	585
278	585
279	585
280	586
280	562, 563, 564
E 280	562, 563, 564
285	565
E 285	565
286	565
289 - 291	584
291	474
292 - 293	584
298	575
298-04	575
298-05	575
299	575
300	586
303	537
304 - 305	537
304	121
306	124
306 G	126
308	127
312	533
314	533
315	534
316	534
320	535
321	535
322	535
324	535
328	535
329	535
340	537





INDEX	
Article No.	Page
365	535
365	474
E 365	535
369	537
372	465
373	537
376	536
379	536
380	536
384	537
385	537
400	121
401	465
402	465
403	465
404	465
406	465
V 406	515
407	465
409 - 410	466
411	466
420	220
420	538
421	538
422	538
423	538
424 - 8524 SS	538
425 - 8526 SS	538
470	220
471	220
471-023	221
471-042	221
471-044	221
480 - 490	220
499	220
500 F	430
500 ST	430
501 M	58
502 M	497
502 P	497
503 M	498
504 A	499
504 M	498
505 A	499
505 M	498
513	474
525 H	431
534	130
570 H	439
575 F + 575 FM	437
600 E + 600 H	428
600 IH	428
E 600 E + E 600 H	428
601 - 609	579
601 H	431
609 H	434
E 609 H	434
611	583
614	583
KB 619 - KB 630	225
620-024	224
620 - 630	225
620 E + 620 H	432
E 620 E + E 620 H	432
DP 621	478
622 H	444

INDEX	
Article No.	Page
622	579
625	112
626	137
626 S	137
KD 626	137
E 630 E + E 630 H	429
631	574
635	225
636	141
637	141
639	141
640	582
640 E + 640 H	428
641	583
642	582
642 SP	582
643	574
644 - 646	469
645	469
646 H	433
647 - 648	581
649	141
652	576
653	576
654	576
670	226
670 K	226
671	226
671-022	224
672	226
673	226
673 K	226
673 L	226
674	227
676	227
677 H	439
680	222
TIN 680	223
685	222
685 K	222
685 X	223
TIN 685	223
686	223
687 TX	223
TIN 687 TX	224
688 TX	223
690	222
690 PZD	222
TIN 690	224
TIN 690 PZD	224
693-024	225
698	227
698-024	225
699	227
699 L	227
700	227
702	466
703 M	467
705 M	467
706	467
708	303
710	467
710-80	467
711	467
720	468
721	468

INDEX	
Article No.	Page
722-1	468
722-1 ESD	468
722-2	468
722-3/-4	468
722-5/-6	468
745	467
746	467
753	236
753-12 - 8572-02	242
753-13 - 8572-03	242
753-14 - 8572-04	243
754	244
755	259
756	259
757	259
758	259
759	260
760	261
761	262
762	262
763	237
765	261
KB 819 - KB 830	229
840	540
841	540
842	540
850/18x	415
850/x33	414
860 - 861	541
E 860 - E 861	541
870	541
870	229
E 870	541
871	229
871-021	229
872	229
880	228
885	228
885 X	228
886	228
887 TX	229
890	228
890 PZD	228
894	114, 115
VDE 894	504
895	117
900 51	480
900 52 LED	480
900 53	480
900 54 LED	481
900 55	481
900 56	481
900 58	481
900 59	481
900 60	481
900 61	482
H 900	482
H 900 60	482
LM 900 08	483
LM 900 13	483
LM 900 21	483
LM 900 21 S	483
LM 900 36	483
901 57	482
901 58	483
ST 901 57	483





INDEX	Page
Article No.	
905	587
906	587
907	587
VDE 910	514
VDE 911	514
VDE 912	514
VDE 913	515
VDE 914	515
920	487
921	487
922	487
923	487
924	487
1000	58
VDE 1001	511
S 1002 M.	69
S 1004 M.	63
S 1005 A	77
S 1006 M.	71
S 1007 M.	76
S 1008 M.	73
1014 L - 1015 L	51
1016	70
1016 L - 1018 L	51
S 1019	74
1021	297
S 1022	75
S 1023 M.	512
S 1023 M.	72
S 1024	67
S 1025	66
VDE 1030	513
1050 M.	59
WT 1056 1	484
WT 1056 2	484
WT 1056 3	484
WT 1056 4	484
WT 1056 5	484
WT 1056 6	485
WT 1056 7	485
WT 1056 8	485
WT 1056 9	485
WT 1056 10	485
WT 1056 11	486
WT 1056 12	486
WT 1056 13	486
1072 ES.	30, 49
1072 K.	31, 49
1090	59
1090	512
1091	61
1091	513
1092	62
S 1093	62
S 1093	514
1104	472
1114	472
1130	457
1132	457
S 1150 M.	65
S 1151 A	77
S 1151 M.	68
1190	457
1263	48
1263	60
1265	60

INDEX	Page
Article No.	
1265	48
1277	472
1335	48
1335	61
1350	472
1370 Z.	49
1400	40
S 1400 GA.	78
S 1400 GM	64
S 1400 ZM	65
1401	40
1405	39
1410 L.	49
1420 L.	49
1430	30
1431	30
1433-1072 ES	30
1440	50
1440 Z.	50
1441 Z.	50
1450 L.	79
1450 LHG	80
1450 LHGZ	81
1500 BL	41
1500 CT1-2.	90
1500 CT1-6.	90
1500 CT1-7 R	90
1500 CT1-7 RA.	90
1500 CT1-7 URA	90
1500 CT1-19.	90
1500 CT1-19 IS	91
1500 CT1-20.	91
1500 CT1-30.	91
1500 CT1-34.	91
1500 CT1-142	92
1500 CT1-350	92
1500 CT1-400	92
1500 CT1-534	92
1500 CT1-711	92
1500 CT1-1993 T	93
1500 CT1-1993 U-20.	92
1500 CT1-2133	93
1500 CT1-2150 PH	93
1500 CT1-2150 PZ.	93
1500 CT1-2163 BTX.	93
1500 CT1-2163 TXB.	93
1500 CT1-8000	93
1500 CT1-D 19.	91
1500 CT1-IN 19 LKM.	91
1500 CT1-ITX 19 LKP.	91
1500 CT1-ITX 30	91
1500 CT1-K 1900.	92
1500 CT1-VDE 142.	92
1500 CT1-VDE 2170 PZ.	93
1500 CT2-1 B	90
1500 CT2-7.	90
1500 CT2-7-32.	90
1500 CT2-DT 42.	92
1500 ED-30	89
1500 ED-70	89
1500 ED-70 K	89
1500 ED-70 S	89
1500 ED-70 XL	89
1500 ED-85	89
1500 ED-150 K.	89
1500 E-N L	89

INDEX	Page
Article No.	
1500 ES-1.07	89
1500 ES-1 B	85
1500 ES-2	85
1500 ES-2 B	85
1500 ES-6.	85
1500 ES-7	85
1500 ES-7-32.	85
1500 ES-7 R	85
1500 ES-19.	85
1500 ES-19 IS.	86
1500 ES-20.	86
1500 ES-30.	86
1500 ES-34.	87
1500 ES-137.	87
1500 ES-145.	87
1500 ES-350.	87
1500 ES-400.	87
1500 ES-534.	87
1500 ES-711.	87
1500 ES-1993 T	88
1500 ES-1993 U-20.	88
1500 ES-2133	88
1500 ES-2150 PH.	88
1500 ES-2150 PZ.	88
1500 ES-2163 BTX.	88
1500 ES-2163 TXB.	88
1500 ES-8000	89
1500 ES/CT-20 BIT.	86, 91
1500 ES-D 19	86
1500 ES-DT 42	87
1500 ES-IN 19 LKM	86
1500 ES-ITX 19 LKP	86
1500 ES-ITX 30	86
1500 ES-K 19 L.	86
1500 ES-K 1900.	88
1500 E-S L	89
1500 ES-VDE 145.	87
1500 ES-VDE 2170 PZ	88
1500 H 0.	42
1500 H 1.	42
1500 H 2 - 1500 H 3	42
1500 H 4.	43
1500 H 5.	43
1500 H 6.	43
1500 H 7.	31
1500 H 8.	43
1500 H 9.	43
1500 H 10.	43
1500 H 11.	43
1500 H 13.	41
1500 H 14.	31
1500 H 15.	41
1500 H 16.	41
1500 H 18.	43
1500 H 19.	43
1500 H 20.	44
1500 H 21.	44
1500 H 22.	44
1500 H 23.	44
1500 H 24.	44
1500 H 25.	44
1500 H 26.	44
1500 H 27.	44
1500 H 28.	44
1500 H 29.	44
1500 H 30.	45





INDEX	
Article No.	Page
1500 H 31	45
1500 H 32	45
1500 H 33	45
1500 H 34	45
1500 H 35	45
1500 H 36	45
1500 H 37 - 1500 H 38	45
1500 HS	47
1500 ST	47
BR 1500 LH	37
E-1500 - E-3000	42
R 1500 L	40
S 1500 ES-01	82
S 1500 ES-02	83
S 1500 ES-03	84
VS 1500 H	46
1502	36
1504	34
1504 XL	33
BR 1504	35
R 1504 L	38
R 1504 XL-L	38
1505	32
B 1510 - B 1511	39
B 1525	38
1578	29
1580	29
E-1580	42
KSF 1580	31
VS 1582	46
1585	26
1600	574, 583
K 1900	219
K 1900-013	219
1930	186
KB 1930	214
VS 1930	181
1932	186
KB 1932	214
1940	186
KB 1970 - KB 1975	215
1981 K	186
1985	186
1987	186
1987 A	186
NC 1987	493
VDE 1988 - VDE 1989 T	505
1990	187
1990 A	187
1990 KR	187
KB 1990	214
NC 1990	493
VDE 1990	505
VDE 1991	505
1993 ALU-10	179
1993 GU-3	180
1993 GU-10 XL	179
1993 U-3	179
1993 U-10 K	180
1993 U-10 L	178
1993 U-10 T	178
1993 U-20	178
1993 Z-94	180
NC 1993 U-10 T	493
VDE 1993 U	505
1994	187

INDEX	
Article No.	Page
1995	187
KB 1995	214
1996 - 1997	187
1998	188
2000	28
2000 HP	31
2003	22
2004	20
2004 HP	31
R 2004 L	31
RB 2004 L	31
2005	18
SL 2013	157
2030	156
S 2032-05	157
KB 2070 - KB 2075	211
2087	156
2087 A	156
2088	156
2090	156
2090 A	156
2090 KR	156
KB 2090	211
2093 HR-94	151
2093 U-3	150
2093 U-3 T	151
2093 U-10	150
2093 U-20	150
2093 Z-94	151
2094	156
2095	157
2097	157
2098	157
2098 K	157
2098 T	157
2099	157
2104	451
2123	472
2132	207
KB 2132	217
2133	135
VDE 2133	504
KB 2137	217
2140	304, 305
2141 IP	304
2141 IS	304
2141 PH	304
2141 PZ	304
2141 TX	304
2150	291
2150-2160 PH	292
2150-2160 PZ-06	293
NC 2150	494
VS 2150-2154	294
VS 2150 XL	294
2153	291
2154	291
2154-2160 PH-07	293
2154SK	295
SK 2154 PH-06	295
VS 2155 S	293
2160 PH	291
2160 PHZ-06	293
2160 PZ	292
2160SK PH	295
2160SK PZ	295

INDEX	
Article No.	Page
NC 2160 PH	494
VDE 2160 PH	506
VDE 2160 PZ	506
VS 2160-2161	294
2161 PH	291
2161 PZ	292
2163 BK	292
2163 BTX	292, 293
2163 TXB	292
2163 TXB-05	293
VS 2163	294
2170	291
KB 2170 - KB 2175	218
VDE 2170	506
VDE 2170-2160 PH-077	506
2187	207
2190	208
KB 2190	218
2193 U-3	206
2193 U-10	206
2193 Z-94	206
2194	208
2195	208
KB 2195	218
2200 - 2201	458
2261	530
E 2261	530
2265	530
E 2265	530
2268	530
E 2268	530
2300	529
E 2300	529
2303	527
E 2303	527
2320	529
2325	527
2330	531
2333	531
2410	545
2415	544
E 2415	544
2420	545
2423	545
2424	545
2425	545
2430	30
2450	544
2454	552
E 2454 - E 2456	553
2455	552
2456	552
2500	28
2525-520	25
2525 HP	31
2535	25
2545 - 2546 - 2550	24
E-2545 - E-3000	42
2546	30
2589	561
2608	561
2630	560
2631	560
2632	560
2633	561
2634	561





INDEX	Page
Article No.	
2635	561
2639	561
2640	560
2649	560
2650	560
2670	561
2671	561
2780 - 2785	548
E 2780 - E 2785	548
2781 - 2786	549
E 2781 - E 2786	549
2782 - 2787	550
E 2782 - E 2787	550
3000	23
3010	27
SL 3014	171
3019	170
KB 3019	212
3020	170
KB 3020	212
KB 3070 - KB 3075	212
3081	170
3084	170
3087	170
3087 A	170
NC 3087	492
3090	170
3090 A	171
3090 KR	171
KB 3090	212
NC 3090	492
3093 ALU-10	164
3093 GU-3	165
3093 U-3	164
3093 U-3 T	165
3093 U-10	164
3093 U-10 K	165
3093 U-20	164
3093 Z-94	165
NC 3093 U-10	492
3094	171
3095	171
KB 3095	212
3096	171
3098	171
3112 - DS 3112	133
3114 - DS 3114	130
3165	534
3166	534
3170	533
3171	533
3173 - 3174	533
3175	533
3181	534
E 3181	534
3200	457
3219	203
KB 3219	216
3221	203
KB 3221	216
KB 3270 - KB 3275	216
3287	203
3290	203
KB 3290	216
3293 U-2	200
3293 U-3	200

INDEX	Page
Article No.	
3293 U-10	200
3293 Z-94	201
3294	203
3295	203
KB 3295	216
3296	203
KB 3721	218
KB 3764	219
KB 3770 - KB 3775	219
3785	536
3810	536
4100 - 4301	256
4100-G - 4301-G	257
4150 - 4151	257
4400 - 4485	254
4400-G - 4440-G	255
VDE 4507	504
4522	475
VDE 4522	515
VDE 4527	515
4528	332
4533	466
4534	466
4549 - 4550	253
4549 - 6551	252
4549-G - 4550-G	253
4550	253
4588	583
4589	583
4610	305
4611	305
4612	579
V 4614 PLUS	506
4615	305
4629	332
4900	496
5700	539
5703	539
6002	470
6003	470
6004	470
6101	470
6105	470
6160	470
6161	470
6162	470
6163	470
6164	470
6166-18	471
6166-20	471
6170-07	471
KB 6437	219
KB 6470 - KB 6475	219
6951	475
7112	268
7118	269
7212	268
7218	269
7312	268
7412	268
7418	269
7460 Z - 7471 Z	249
7480 SE - 7482 SE	249
7554 AM - 7586 EKL	248
7612	268
7618	269

INDEX	Page
Article No.	
7812	268
7818	269
7912	268
7918	269
8000 A 0 - A 4	340
8000 A 0G - A 2G	340
8000 A 01 - A 41	340
8000 A 01G - A 21G	340
8000 A 02 - A 42	341
8000 A 4 - A 6	341
8000 A 41 - A 61	341
8000 J 0 - J 4	342
8000 J 01 - J 41	342
8000 J 02 - J 42	343
8000 J 4 - J 6	343
8000 J 41 - J 61	343
S 8000	355
S 8003 JC	352
S 8003 TL	352
VDE S 8003	510
VDE S 8003 H	510
S 8004 TL	353
8005 A	344
8005 J	344
E-8005 A	344
E-8005 J	344
8006	345
E-8006	345
S 8006	345
S 8008	355
8010 A 0 - A 4	340
8010 A 01 - A 41	341
8010 J 0 - J 4	342
8010 J 01 - J 41	342
S 8010	355
S 8024	355
S 8028	356
V 8091	506
8093	323
8094	323
VDE 8094	507
8095	323
8096	473
8097	324
8098	324
VDE 8098	507
VDE 8098 H	507
8099	324
VDE 8099	507
VDE 8099 H	507
8100 - 8116	245
S 8100	356
8101	335
8102	335
8103	335
8110	319
8112	319
8120	319
VDE 8120	509
VDE 8120 H	509
8122	319
VDE 8122	509
VDE 8122 H	509
8132	320
NC 8132	495
VDE 8132	509





INDEX	
Article No.	Page
VDE 8132 H	510
8132 AB	320
NC 8132 AB	495
VDE 8132 AB	510
VDE 8132 AB H.	510
8133	321
8134	583
8135	321
8136	322
8136 AB	322
8137	322
8138	322
8139	334
8140	336
8140-01/-02	336
8140-03/-04/-05	336
8140-06/-07/-08	337
8140-09/-10/-11	337
8140-12	337
8140-13/-14/-15	337
8140-16/-17	337
8140-18/-19	337
8140-20	337
8140-21/-22	337
8140-23	337
8140-24/-25	337
S 8140 A	338
S 8140 D	338
S 8140 E	338
S 8140 J	338
S 8140 PA	338
S 8140 PE	339
S 8140 PN	339
8141	334
8142	334
8143 - 8144	334
8145	334
8146	333
8147	332
8148	333
8149	333
8152 - 8153	334
8200	245
8200	314
S 8200 JC	352
S 8200 TL	352
8210	314
NC 8210	495
8245	314
8248	313
8250	315
VDE 8250	508
VDE 8250 H	508
8272	469
8276	574
8301 - 8305	263
S 8303 JC	353
S 8303 TL	353
8305-2	328
8305-4	328
8305-5	329
8305-6	328
8305-7	329
8305-9	329
S 8305 ESD	325
8306-1	326

INDEX	
Article No.	Page
8306-2	326
8306-4	326
8306-5	326
8306-6	326
8306-7	327
8306-8	326
8306-9	327
8306-10	327
8307-3	328
8307-4	328
8307-7	328
8308-1	327
8308-3	327
8308-4	327
8308-6	329
8313	316
8314	316
VDE 8314	508
VDE 8314 H	508
8315	316
VDE 8315 H	508
8316	317
NC 8316	495
VDE 8316	508
VDE 8316 H	509
8317	323
8317	577
8317	471
8318	317
8330	317
8350-2	330
8350-3	330
8350-5	330
8350-6	330
8350-7	330
8350-8	330
8350-9	331
8351-1	331
8352-1	331
8352-2	331
8352-3	331
8353-1	331
8353-2	332
8353-3	332
8354-1	332
8367	318
VDE 8367	508
8370	318
8380	318
8381	318
8385	348
8386	348
8386	470
8455	276
8460 Z - 8471 Z	246
8480 SE - 8482 SE	247
8531	538
8532	586
8533	586
8551	468, 469
8552	468
8553	469
8554 AM - 8572 F	240
8600	272
8601 - 8607	274
8601	431

INDEX	
Article No.	Page
8608	273
8612	277
8613	275
8615 - 8660	275
8701	464
8719	464
8722	464
8725	464
8726	574
8728	464
8729	464
8730	464
8754	265
8755	265
8756	265
8790 - 8793	265
8791	264
8792	264
8794	266, 267
8795	266
8796	266
8797	265, 266
8798	267
8799	267
8800	262
9100	520
9144	525
9850	349
E 9850	349
52887 TE - 55108 TE	473
329001	470
DIN	477
DINB	477
DIS	477
DISB	477
TGB	479
TGE	479
TGM	479
TGP	479



CONTACT



SALES OFFICES

Verkaufsgebiet GEDORE Süd	Remscheider Straße 149 42899 Remscheid	Tel.: +49 (0) 98 53-38 57 93 Fax: +49 (0) 98 53-38 57 95 sued@gedore.de
Verkaufsgebiet GEDORE Südwest	Remscheider Straße 149 42899 Remscheid	Tel.: +49 (0) 21 91-596-900 Fax: +49 (0) 2191-596-999 suedwest@gedore.de
Verkaufsbüro GEDORE Mitte	Frankfurter Straße 93 65779 Kelkheim	Tel.: +49 (0) 6195-70 90 92 Fax: +49 (0) 6195-70 90 96 mitte@gedore.de
Verkaufsgebiet GEDORE West	Remscheider Straße 149 42899 Remscheid	Tel.: +49 (0) 21 91-596-900 Fax: +49 (0) 2191-596-999 west@gedore.de
Alexander Dehnert Industrievertretungen	Sokelantstraße 23 30165 Hannover	Tel.: +49 (0) 511-6 49 02 08 Fax: +49 (0) 511-6 49 84 55 dehnert@damitgehts.de
Vogt Industrievertretung GmbH	Neusser Straße 7 33649 Bielefeld	Tel.: +49 (0) 521-44 39 32 Fax: +49 (0) 521-44 56 53 vogt@gedore.de
August Friederichs Verkaufsgebiet Nord	Moorfleeter Straße 43 22113 Hamburg	Tel.: +49 (0) 40-7 36 03 50 Fax: +49 (0) 40-73 60 35 20 friederichs@gedore.de
Verkaufsgebiet GEDORE Ost	Heinrich-Lorenz-Straße 2-4 09120 Chemnitz	Tel.: +49 (0) 371-5 28 94 09 Fax: +49 (0) 371-5 28 94 54 ost@gedore.de

MANUFACTURING COMPANIES

GEDORE Werkzeugfabrik Otto Dowidat KG	Remscheider Straße 149 42899 Remscheid	Tel.: +49 (0) 21 91-596-0 Fax: +49 (0) 21 91-596-230 zentrale@gedore.de
Krumm KG Gesenkschmiede Werkzeugfabrik	Lange Straße 7 a 42857 Remscheid	Tel.: +49 (0) 21 91-986-0 Fax: +49 (0) 21 91-986-99 krumm@gedore.de
DAKO Werk Dowidat KG Werkzeugfabrik	Handelsweg 5-11 42897 Remscheid	Tel.: +49 (0) 21 91-697-0 Fax: +49 (0) 21 91-66 15 40 dako@gedore.de
Richard Abr. Herder KG	Rathausstraße 22 42659 Solingen	Tel.: +49 (0) 21 2-888-0 Fax: +49 (0) 21 2-888-100 rahsol@gedore.de
Metec GmbH Metallwarentechnik	Gewerbegebiet Süd 39443 Förderstedt	Tel.: +49 (0) 3 92 66-760-0 Fax: +49 (0) 3 92 66-760-23 info@metec-gedore.de
KLANN Spezial-Werkzeugbau-GmbH	Breslauer Straße 41 78166 Donaueschingen	Tel.: +49 (0) 7 71-8 32 23-0 Fax: +49 (0) 7 71-8 32 23-0 info@klann-online.de
LÖSOMAT Schraubtechnik Neef GmbH	Bertha-Benz-Str. 12 71665 Vaihingen / Enz	Tel.: +49 (0) 70 42 / 94 41 -0 Fax: +49 (0) 70 42 / 94 41 41 info@loesomat.de www.loesomat.de



**GEDORE Tool Center KG**

Remscheider Straße 149
42899 Remscheid · GERMANY
Fon +49 (0) 21 91-596-0
Fax +49 (0) 21 91-596-230

Vertrieb DEUTSCHLAND

Fon +49 (0) 21 91-596-900
Fax +49 (0) 21 91-596-999

Sales INTERNATIONAL

Fon +49 (0) 21 91-596-910
Fax +49 (0) 21 91-596-911

gtc@gedore.com
www.gedore.com

INTERNATIONAL

GEDORE Austria GmbH	Gedore-Str. 1 8190 Birkfeld / Stmk. Austria	Tel. +43 (0) 3174 / 363 60 Fax +43 (0) 3174 / 363 83 20 verkbiirkfeld@gedore.at www.gedore.at
GEDORE IBÉRICA S.L.	Arangutxi 12 Poligono Industrial de Júndiz 01015 Vitoria Alava Spain	Tel. +34-902-29 22 62 Fax +34-945-29 21 99 gedore@gedore.es www.gedore.es
GEDORE-KLANN France SARL	Z.I. des Béthunes / St Ouen l'Aumône 10 Rue du Bois du Pont, B.P. 79144 95074 Cergy Pontoise Cedex France	Tel. +33 (0) 1 34 40 16 60 Fax +33 (0) 1 34 40 16 61 info-klann@gedore.fr www.gedore.fr www.klann.fr
OMNITOOL GmbH	Flustr. 25 8957 Spreitenbach Switzerland	Tel. +41 (0) 56 / 418 40 50 Fax +41 (0) 56 / 418 40 55 omnitool@gedore.de www.omnitool.ch
GEDORE UK Limited	Marton Street SKIPTON BD23 1TF North Yorkshire United Kingdom	Tel. +44 (0) 1756 / 70 67 00 Fax +44 (0) 1756 / 79 80 83 sales@hydleman.co.uk www.gedore.com
TECHNAG B.V.	Flemingweg 7 2408 AV Alphen aan den Rijn Netherlands	Tel. +31 (0) 172 / 42 73 50 Fax +31 (0) 172 / 42 73 60 info@technag.nl www.gedore.nl
GEDORE POLSKA Sp. z o.o.	ul. Żwirki i Wigury 56a 43-190 Mikołów Poland	Tel. +48 (0) 32 / 738-40 10 Fax +48 (0) 32 / 738-40 20 gedore@gedore.pl www.gedore.pl
GEDORE Moskau GmbH	Novatorov Str. 1 119421 Moskau Russia	Tel. +7 (0) 495 / 748 2000 Fax +7 (0) 495 / 988 5757 info@gedore.ru www.gedore.ru
GEDORE TOOLS, INC.	7187 Bryhawke Circle, Suite 700 North Charleston, SC 29418 USA	Tel. +1-843 / 225 50 15 Fax +1-843 / 225 50 20 support@gedoretools.com www.gedoretools.com
GEDORE Nordic ApS	Haderslevvej 88 6000 Kolding Dänemark	Tel. +45 29808404 tim.lissau@gedore.com www.gedore.com
GEDORE Tool Trading (Shanghai) Co., Ltd.	Building # 76, 3700 Huaning Road Xinzhuang Industrial Zone, Minhang District Shanghai 201108 P.R. China	Tel. +86-21-51 59 18 57 Fax +86-21-51 59 18 58 Service Hotline: 400 880 1858 info@gedore.cn www.gedore.cn
GEDORE Tools (Beijing) Co., Ltd.	Floor 2, Building 16, Area 7 Advanced Business Park 188 South 4th Ring Road Fengtai District 100070 Beijing, P.R. China	Tel. +86-10-83 61 36 21 Fax +86-10-63 70 13 00 Service Hotline: 400 880 1858 www.gedore.cn
Ferramentas GEDORE do Brasil S.A.	Rua Vincentina Maria Fidelis, 275 CEP 93025-340 Sao Leopoldo-RS Südamerika / Brasilien	Tel. +55 51-3589-9200 Fax +55 51-3589-9222 sales@gedore.com.br www.gedore.com.br
GEDORE Tools S.A. (Pty) Ltd.	P.O. Box 68 3620 New Germany Afrika / Südafrika	Tel. +27 (0) 31/ 705 3587 Fax +27 (0) 31/ 705 3277 general@gedoresa.co.za www.gedore.co.za



DISCLAIMER • GENERAL

+ INFORMATION + + CREDITS

This catalogue replaces all previous editions.
The photographs and technical details are of the articles offered at present.

Since we are constantly updating and improving our products to keep them at the present state of the art, we reserve the right to make modifications and changes with regard to appearance, dimensions (always in "mm", if not otherwise stated), weights and properties, as well as in performance. No claim for correction or replacement supplies may thus be made with regard to products already delivered.

Cancellations may be made at any time without there being any grounds for legal claim. All information on use or safety is non-binding; nor does it replace any legal regulations or those made by professional or trade associations.

We do not accept any liability for printing errors. No supplemental items (tools etc.) are included in the scope of supply.

Reprinting, even of excerpts, requires the previous permission in writing by GEDORE. All rights reserved worldwide.

We refer to our current general agreements and commercial conditions as well as our delivery and payment conditions in the imprint under www.gedore.com

Sales, invoicing and despatch of METEC products are subject to separate delivery and payment terms and arranged through METEC GmbH Metallwarentechnik.



GEDORE Tool Center KG
Remscheider Straße 149
42899 Remscheid · GERMANY
Postfach 120361
42873 Remscheid
Fon +49 (0) 21 91-596-0
Fax +49 (0) 21 91-596-230
Amtsgericht Wuppertal, HRA 17944

Overall concept, design and layout:
GEDORE Tool Center KG, Remscheid

© Copyright by GEDORE Remscheid



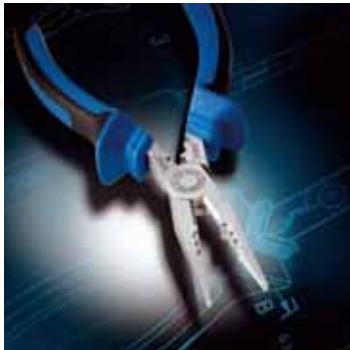
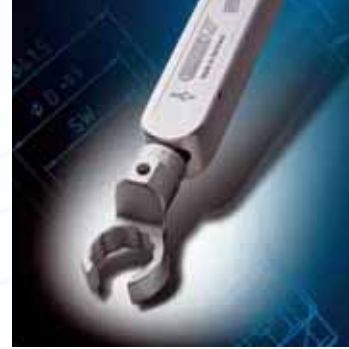
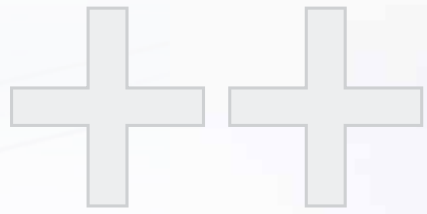



Werkzeuge fürs Leben · Tools for life.

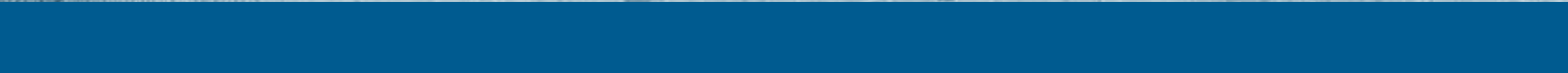

GEDORE Tool Center KG

Remscheider Straße 149
42899 Remscheid · GERMANY
Postfach 120361 · 42873 Remscheid

Fon + 49 (0) 21 91 - 596 - 0
Fax + 49 (0) 21 91 - 596 - 230

gtc@gedore.com · www.gedore.com

Sales GERMANY

Fon + 49 (0) 21 91 - 596 - 900 · Fax + 49 (0) 21 91 - 596 - 999

Sales INTERNATIONAL

Fon + 49 (0) 21 91 - 596 - 910 · Fax + 49 (0) 21 91 - 596 - 911

Amtsgericht Wuppertal, HRA 17944

www.gedore.com